

阅读申明

- 1.本站收集的数据手册和产品资料都来自互联网，版权归原作者所有。如读者和版权方有任何异议请及时告之，我们将妥善解决。
- 2.本站提供的中文数据手册是英文数据手册的中文翻译，其目的是协助用户阅读，该译文无法自动跟随原稿更新，同时也可能存在翻译上的不当。建议读者以英文原稿为参考以便获得更精准的信息。
- 3.本站提供的产品资料，来自厂商的技术支持或者使用者的心得体会等，其内容可能存在描述上的差异，建议读者做出适当判断。
- 4.如需与我们联系，请发邮件到marketing@iczoom.com，主题请标有“数据手册”字样。

Read Statement

1. The datasheets and other product information on the site are all from network reference or other public materials, and the copyright belongs to the original author and original published source. If readers and copyright owners have any objections, please contact us and we will deal with it in a timely manner.
2. The Chinese datasheets provided on the website is a Chinese translation of the English datasheets. Its purpose is for reader's learning exchange only and do not involve commercial purposes. The translation cannot be automatically updated with the original manuscript, and there may also be improper translations. Readers are advised to use the English manuscript as a reference for more accurate information.
3. All product information provided on the website refer to solutions from manufacturers' technical support or users the contents may have differences in description, and readers are advised to take the original article as the standard.
4. If you have any questions, please contact us at marketing@iczoom.com and mark the subject with "Datasheets" .

The BWA series are converter adapters used for connecting connectors of different series.

- (1) Has mating portions compatible in materials and finish with the respective series.
- (2) Conforms in performance to the lower series of the two connectors to be connected.

Converter adapter list

Mating portion 1		Mating portion 2		Part No.	CL No.	Remarks	Shape
Series name	Mating portion	Series name	Mating portion				
N	P	BNC	P	NP-BNCP	311-0050-7		Fig.1
			J	JUG-201A/U	311-0007-8		Fig.2
		M	J	NP-MJ	311-0019-7		Fig.3
			J	N.P-S.J	311-0245-6		Fig.4
		HRM	P	HRM-555S	311-0125-4		Fig.5
			J	HRM-554S	311-0123-9		Fig.6
	J	BNC	P	UG-349/U	311-0004-0		Fig.7
				J	NJ-BNCJ	311-0005-2	
			J	NJ-BNCJ-PA	311-0014-3	Panel-mount type	Fig.9
		M	P	NJ-MP	311-0018-4		Fig.10
			J	NJ-MJ	311-0011-5		Fig.11
		TNC	P	N.J-TNC.P	311-0225-9		Fig.12
		HRM	P	HRM-553S	311-0121-3		Fig.13
				HRM-557S	311-0138-6	Panel-mount type	Fig.14
			J	HRM-552S	311-0119-1		Fig.15
				HRM-556S	311-0127-0	Panel-mount type	Fig.16
BNC	P	M	P	BNCP-MP	311-0062-6		Fig.17
			J	BNCP-MJ	311-0008-0		Fig.18
		S	P	SP-BNCP	311-0055-0		Fig.19
			J	SJ-BNCP	311-0060-0		Fig.20
		UM	J	BNCP-UMJ	311-0065-4		Fig.21
		MSS	P	BNCP-MSSP	311-0107-2		Fig.22
			J	BNCP-MSSJ	311-0082-3		Fig.23
		HRM	P	HRM-519(09)	311-0101-6-09		Fig.24
	J		HRM-518(09)	311-0100-3-09		Fig.25	
	J	UHF	P	UG-273/U	311-0003-7		Fig.26
		M	P	BNCJ-MP	311-0009-3		Fig.27
			J	MJ-BNCJ	311-0020-6		Fig.28
		S	P	SP-BNCJ	311-0058-9		Fig.29
			J	SJ-BNCJ	311-0054-8		Fig.30
				SJ-BNCJ-PA	311-0108-5	Panel-mount type	Fig.31
		TNC	J	BNC.J-TNC.J	311-0194-7		Fig.32
		UM	P	BNCJ-UMP	311-0052-2		Fig.33
J			BNCJ-UMJ	311-0053-5		Fig.34	
	J	BNCJ-UMJ-PA(04)	311-0103-1-04	Panel-mount type	Fig.35		
MSS	P	BNCJ-MSSP	311-0081-0		Fig.36		
	J	BNCJ-MSSJ	311-0066-7		Fig.37		

BWA SERIES RF CO-AXIAL CONNECTORS

Mating portion 1		Mating portion 2		Part No.	CL No.	Remarks	Shape		
Series name	Mating portion	Series name	Mating portion						
BNC	J	HRM	P	HRM-517(09)	311-0099-6-09		Fig.38		
			J	HRM-516(09)	311-0102-9-09		Fig.39		
		POD	P	BNCJ-PODP	311-0160-5		Fig.40		
			J	BNCJ-PODJ	311-0161-8		Fig.41		
		PO6	J	BNCJ-PO6J	311-0167-4		Fig.42		
S	P	HRM	P	HRM-509(09)	311-0093-0-09		Fig.43		
			J	HRM-508(09)	311-0092-7-09		Fig.44		
	J	HRM	P	HRM-507(09)	311-0091-4-09		Fig.45		
				HRM-512(09)	311-0098-3-09	Panel-mount type	Fig.46		
			HRM-512S	311-0144-9	Panel-mount type, S type	Fig.46			
			HRM-506(09)	311-0090-1-09		Fig.47			
			HRM-511(09)	311-0094-2-09	Panel-mount type	Fig.48			
			HRM-511S	311-0143-6	Panel-mount type, S type	Fig.48			
TNC	J	HRM	J	HRMJ-TNCJ-PA	311-0202-3	Panel-mount type	Fig.49		
UM	P	HRM	J	UM.P-HRM.J	311-0176-5		Fig.50		
	J	HRM	J	HRMJ-UMJ	311-0164-6		Fig.51		
HRM	P	POB	P	HRMP-POBP-1	311-0169-0		Fig.52		
			J	HRMP-POBJ	311-0152-7		Fig.53		
		POD	J	HRM.P-POD.J	311-0177-8		Fig.54		
		POD1	J	HRMP-POD1J	311-0253-4		Fig.55		
		PO6	J	HRMP-PO6J	311-0172-4		Fig.56		
		S.FLSFL2	J	HRMP-S.FLJ-2	311-0249-7	For inspecting harnessed parts	Fig.57		
		H.FL	J	HRMP-H.FLJ	311-0232-4	For inspecting harnessed parts	Fig.58		
		HRMM	P	HRMP-HRMMP	311-0250-6		Fig.59		
			J	HRMP-HRMMJ	311-0243-0		Fig.60		
					J	HRMP-HRMMJ-LA	311-0226-1		Fig.61
		J	POB	P	HRMJ-POBP	311-0151-4		Fig.62	
	HRMJ-POBP-PA				311-0206-4		Fig.63		
	J			HRMJ-POBJ	311-0149-2		Fig.64		
				HRMJ-POBJ-PA	311-0150-1		Fig.65		
	POD		P	HRMJ-PODP	311-0157-0		Fig.66		
	POD1		P	HRMJ-POD1P-1	311-0254-7		Fig.67		
	PO6		P	HRMJ-PO6P	311-0173-7		Fig.68		
	PO51		P	HRMJ-PO51P	311-0231-1		Fig.69		
	FL		P	HRMJ-FLP-1	311-0195-0		Fig.70		
			J	HRMJ-FLJ	311-0179-3		Fig.71		
	S.FLSFL2		P	HRMJ-S.FLP	311-0218-3		Fig.72		
	H.FL		P	HRMJ-H.FLP-3	311-0264-0		Fig.73		
	HRMM	P	HRMJ-HRMMP-2	311-0221-8		Fig.74			
HRMJ-HRMMP-LA			311-0227-4		Fig.75				
J		HRMJ-HRMMJ	311-0220-5		Fig.76				

Note 1. Part No. NP-BNCP of Fig.1 is shown that series name N, coupling part p (plug) for connecting part 1 and series name BNC, coupling part P (plug) for connecting part 2.

2. Series name of each connecting parts are shown in order to HIROSE's CL numbers.

Fig.1

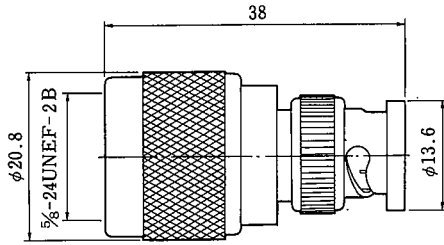

NP-BNCP
CL311-0050-7

Fig.2

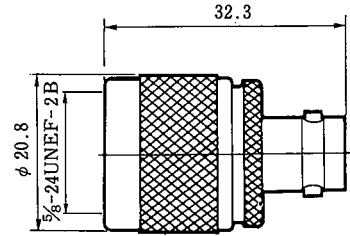

UG-201A/U
CL311-0007-8

Fig.3

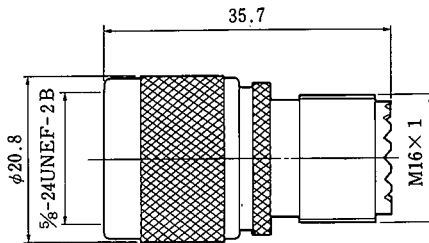

NP-MJ
CL311-0019-7

Fig.4

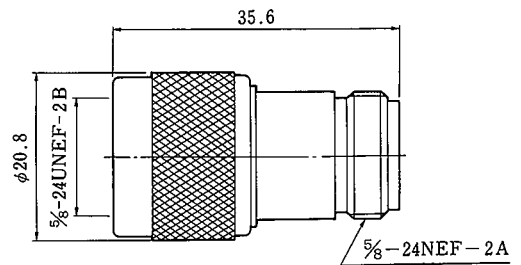

N.P-S.J
CL311-0245-6

Fig.5

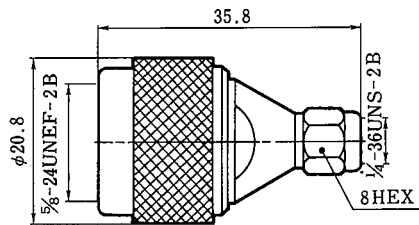

HRM-555S
CL311-0125-4

Fig.6

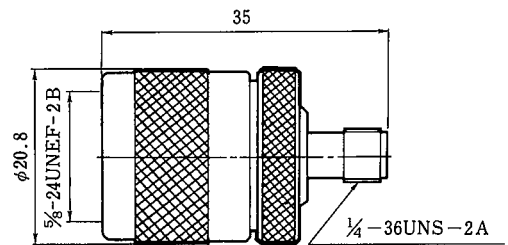

HRM-554S
CL311-0123-9

Fig.7

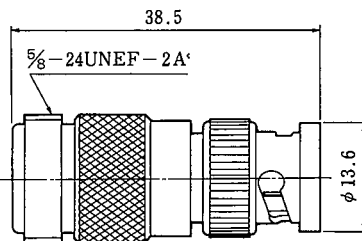

UG-349/U
CL311-0004-0

Fig.8

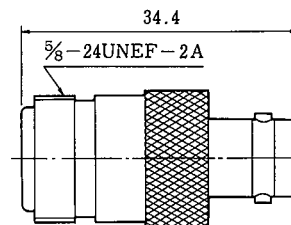

NJ-BNCJ
CL311-0005-2

BWA SERIES RF CO-AXIAL CONNECTORS

Fig.9

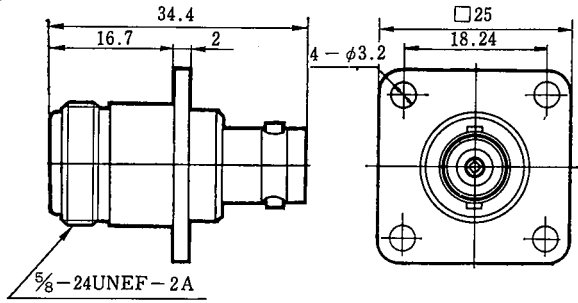

NJ-BNCJ-PA
CL311-0014-3

Fig.10

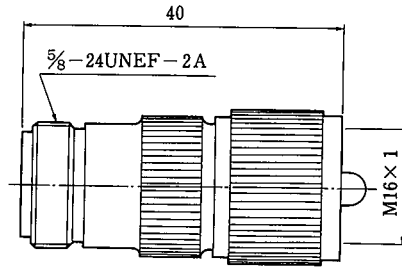

NJ-MP
CL311-0018-4

Fig.11

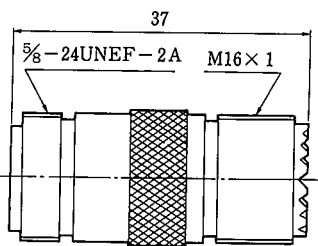

NJ-MJ
CL311-0011-5

Fig.12

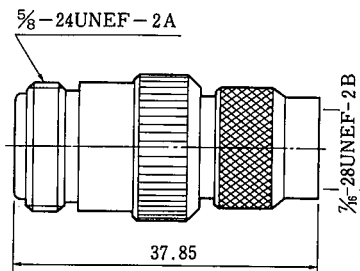

N.J-TNC.P
CL311-0225-9

Fig.13

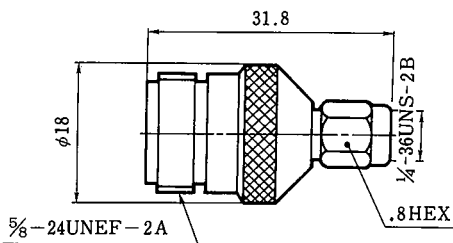

HRM-553S
CL311-0121-3

Fig.14

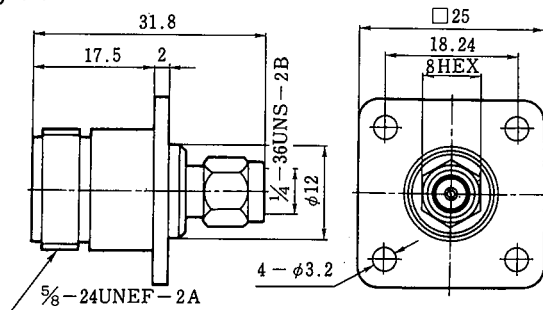

HRM-557S
CL311-0138-6

Fig.15

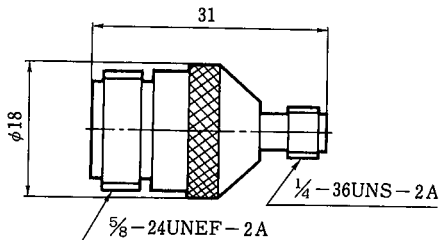

HRM-552S
CL311-0119-1

Fig.16

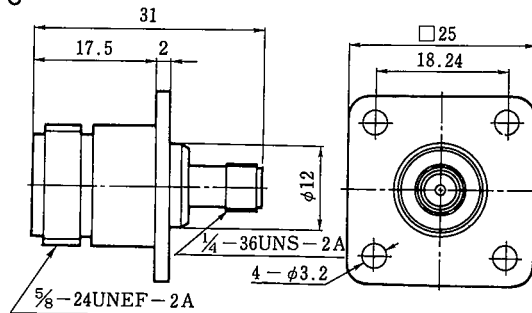

HRM-556S
CL311-0127-0

Fig.17

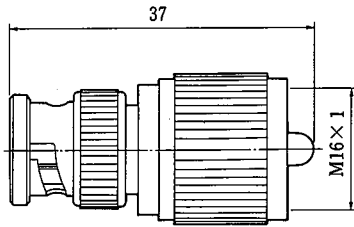

BNCP-MP
CL311-0062-6

Fig.18

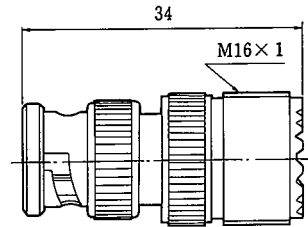

BNCP-MJ
CL311-0008-0

Fig.19

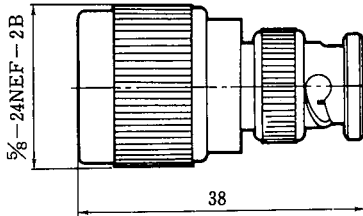

SP-BNCP
CL311-0055-0

Fig.20

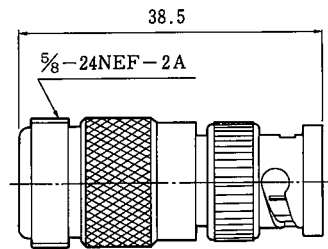

SJ-BNCP
CL311-0060-0

Fig.21

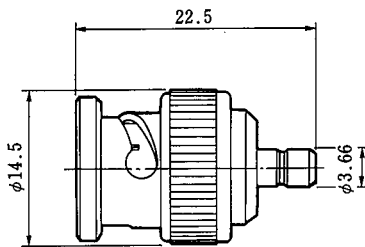

BNCP-UMJ
CL311-0065-4

Fig.22

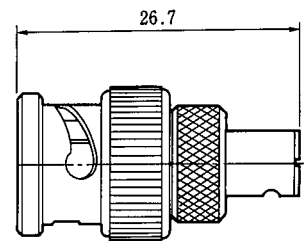

BNCP-MSSP
CL311-0107-2

Fig.23

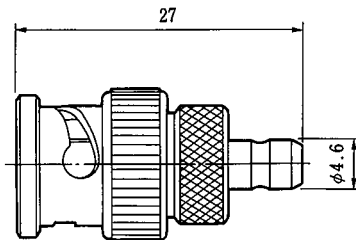

BNCP-MSSJ
CL311-0082-3

Fig.24

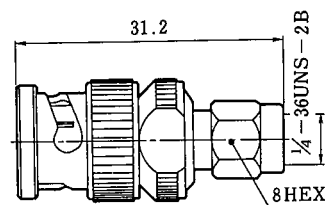

HRM-519(09)
CL311-0101-6-09

BWA SERIES RF CO-AXIAL CONNECTORS

Fig.25

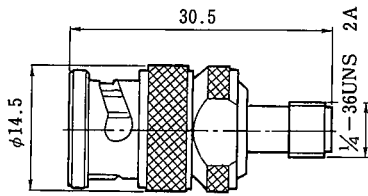

HRM-518(09)
CL311-0100-3-09

Fig.26

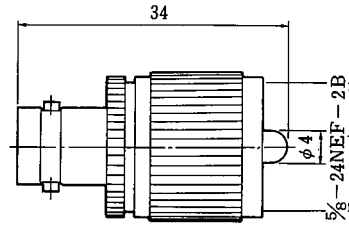

UG-273/U
CL311-0003-7

Fig.27

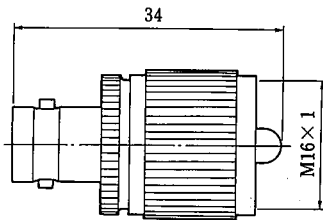

BNCJ-MP
CL311-0009-3

Fig.28

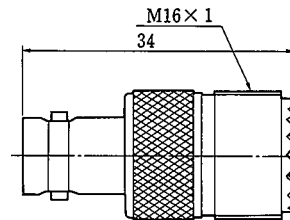

MJ-BNCJ
CL311-0020-6

Fig.29

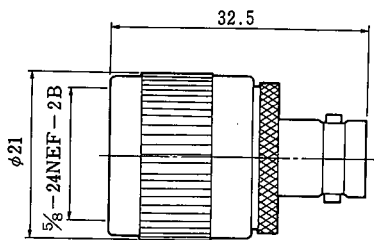

SP-BNCJ
CL311-0058-9

Fig.30

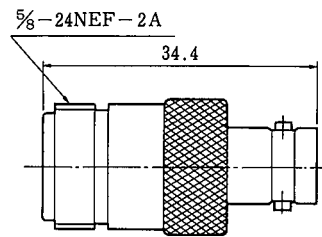

SJ-BNCJ
CL311-0054-8

Fig.31

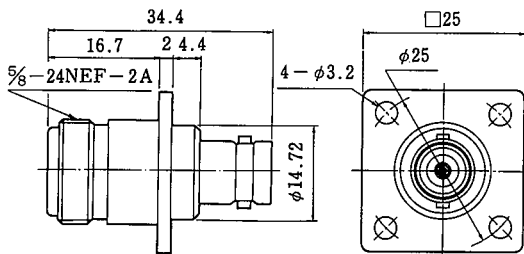

SJ-BNCJ-PA
CL311-0108-5

Fig.32

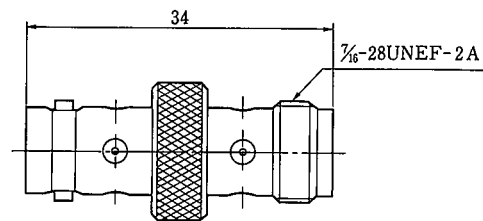

BNC.J-TNC.J
CL311-0194-7

Fig.33

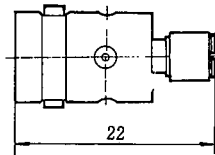

BNCJ-UMP
CL311-0052-2

Fig.34

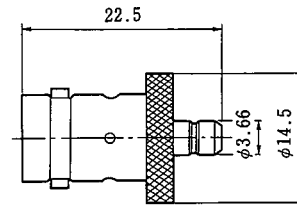

BNCJ-UMJ
CL311-0053-5

Fig.35

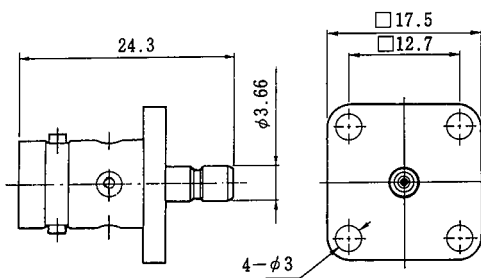

BNCJ-UMJ-PA (04)
CL311-0103-1-04

Fig.36

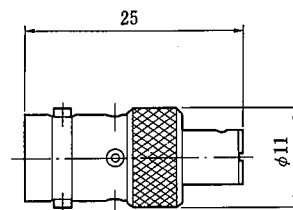

BNCJ-MSSP
CL311-0081-0

Fig.37

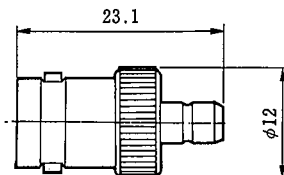

BNCJ-MSSJ
CL311-0066-7

Fig.38

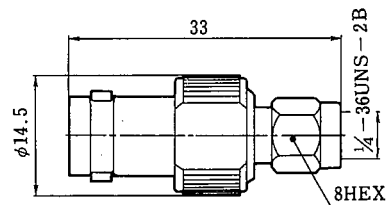

HRM-517 (09)
CL311-0099-6-09

Fig.39

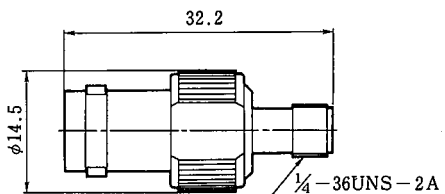

HRM-516 (09)
CL311-0102-9-09

Fig.40

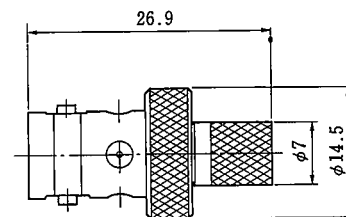

BNCJ-PODP
CL311-0160-5

Fig.41

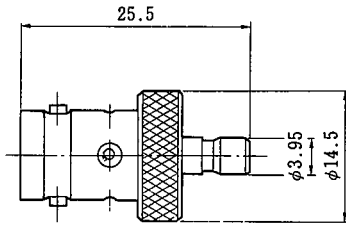

BNCJ-PODJ
CL311-0161-8

Fig.42

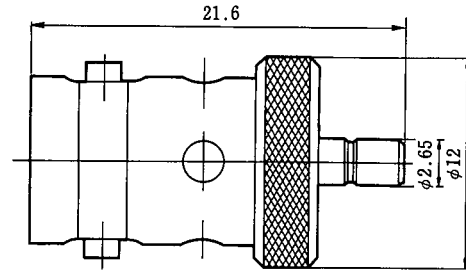

BNCJ-PO6J
CL311-0167-4

Fig.43

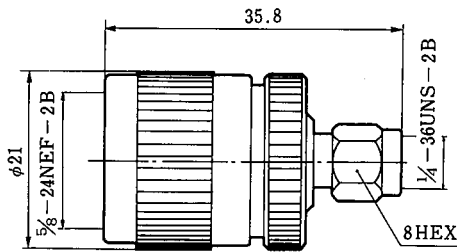

HRM-509 (09)
CL311-0093-0-09

Fig.44

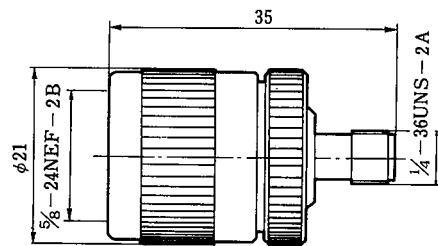

HRM-508 (09)
CL311-0092-7-09

Fig.45

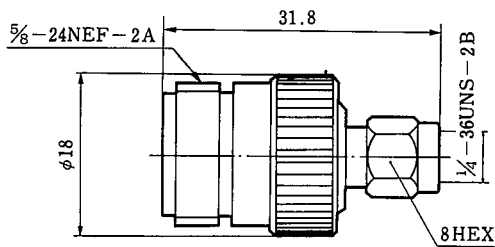

HRM-507 (09)
CL311-0091-4-09

Fig.46

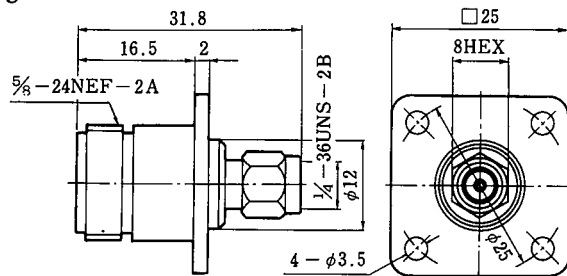

HRM-512 (09)
CL311-0098-3-09

HRM-512S
CL311-0144-9

Fig.47

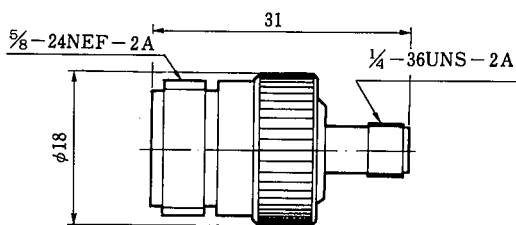

HRM-506 (09)
CL311-0090-1-09

Fig.48

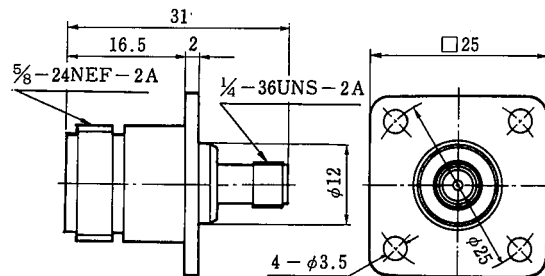

HRM-511 (09)
CL311-0094-2-09

HRM-511S
CL311-0143-6

<p>Fig.49</p> <p>HRMJ-TNCJ-PA CL311-0202-3</p>	<p>Fig.50</p> <p>UM.P-HRM.J CL311-0176-5</p>
<p>Fig.51</p> <p>HRMJ-UMJ CL311-0164-6</p>	<p>Fig.52</p> <p>HRMP-POBP-1 CL311-0169-0</p>
<p>Fig.53</p> <p>HRMP-POBJ CL311-0152-7</p>	<p>Fig.54</p> <p>HRM.P-POD.J CL311-0177-8</p>
<p>Fig.55</p> <p>HRMP-POD1J CL311-0253-4</p>	<p>Fig.56</p> <p>HRMP-PO6J CL311-0172-4</p>

Fig.57

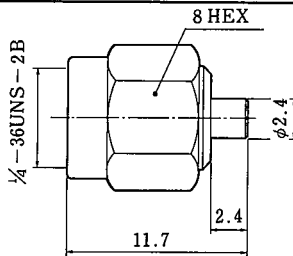

Note : The mating portion on the S. FL side mates with the S. FL and S. FL2 plugs. Having no locking mechanism, however, the S. FL side mating portion can be used only for performance measurement.

HRMP-S.FLJ-2
CL311-0249-7

Fig.58

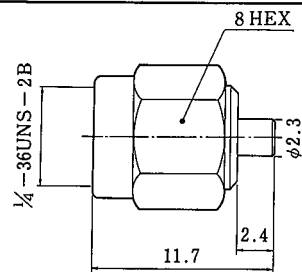

Note : Having no locking mechanism, however, the S. FL side mating portion can be used only for performance measurement.

HRMP-H.FLJ
CL311-0232-4

Fig.59

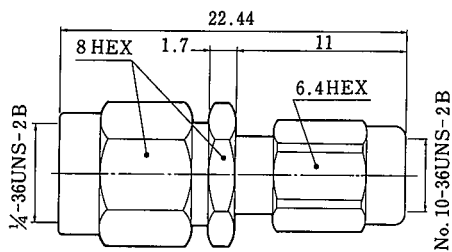

HRMP-HRMMP
CL311-0250-6

Fig.60

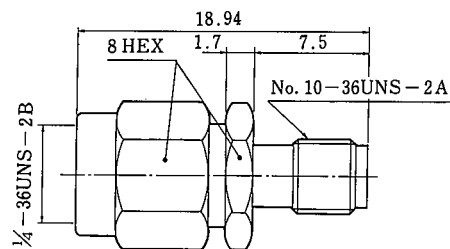

HRMP-HRMMJ
CL311-0243-0

Fig.61

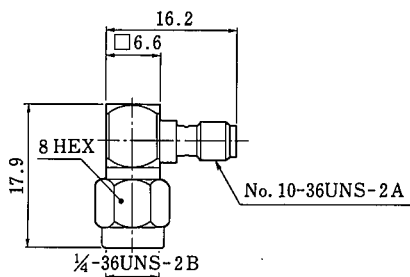

HRMP-HRMMJ-LA
CL311-0226-1

Fig.62

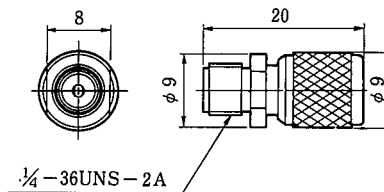

HRMJ-POBP
CL311-0151-4

Fig.63

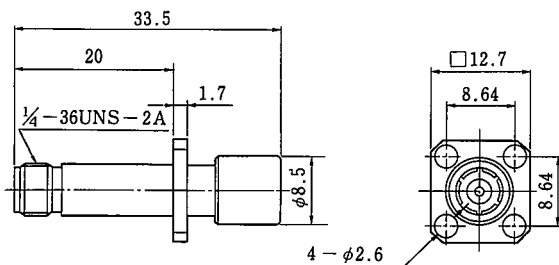

HRMJ-POBP-PA
CL311-0206-4

Fig.64

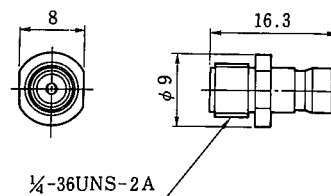

HRMJ-POBJ
CL311-0149-2

Fig.65

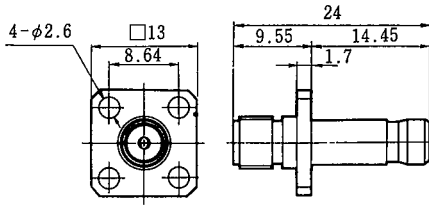

HRMJ-POBJ-PA
CL311-0150-1

Fig.66

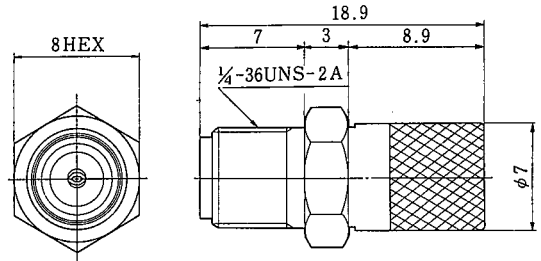

HRMJ-PODP
CL311-0157-0

Fig.67

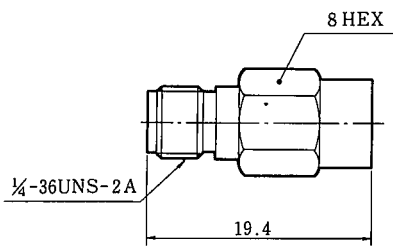

HRMJ-POD1P-1
CL311-0254-7

Fig.68

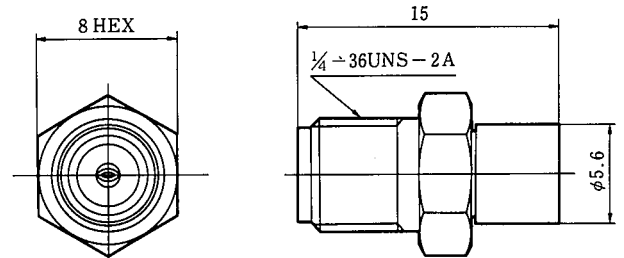

HRMJ-PO6P
CL311-0173-7

Fig.69

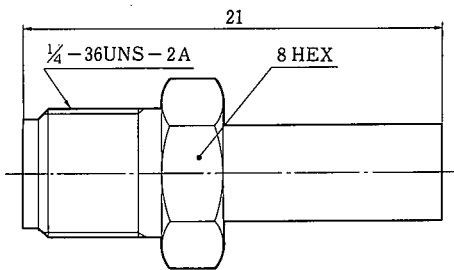

HRMJ-PO51P
CL311-0231-1

Fig.70

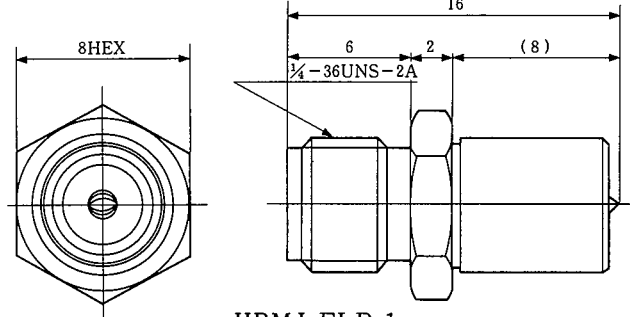

HRMJ-FLP-1
CL311-0195-0

Fig.71

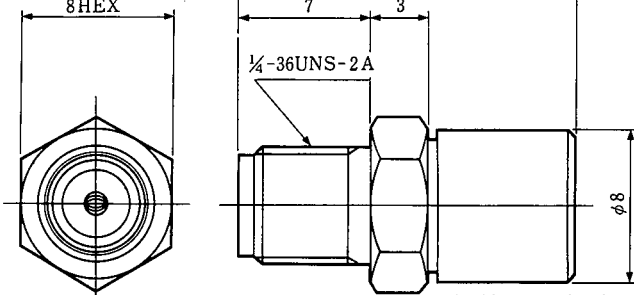

HRMJ-FLJ
CL311-0179-3

Note: Having no locking mechanism, however, the FL side mating portion can be used only for performance measurement.

Fig.72

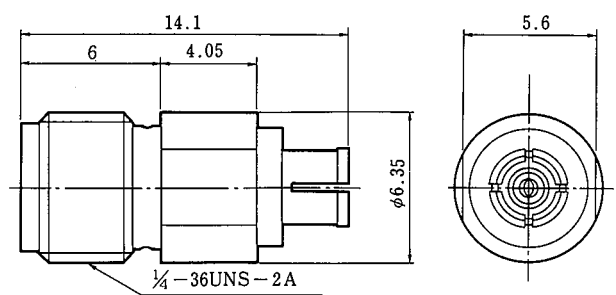

HRMJ-S.FLP
CL311-0218-3

Note: Compatible with S. FL and S. FL2.

BWA SERIES RF CO-AXIAL CONNECTORS

Fig.73

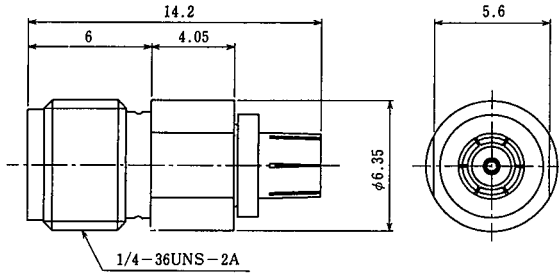

HRMJ-H.FLP-3
CL311-0264-0

Fig.74

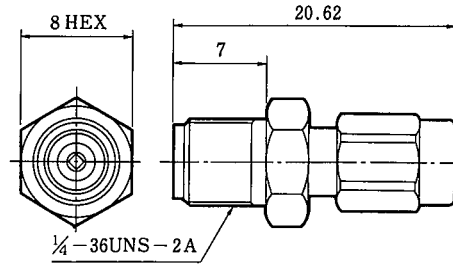

HRMJ-HRMMP-2
CL311-0221-8

Fig.75

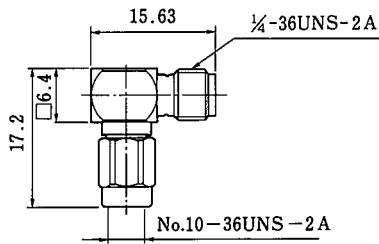

HRMJ-HRMMP-LA
CL311-0227-4

Fig.76

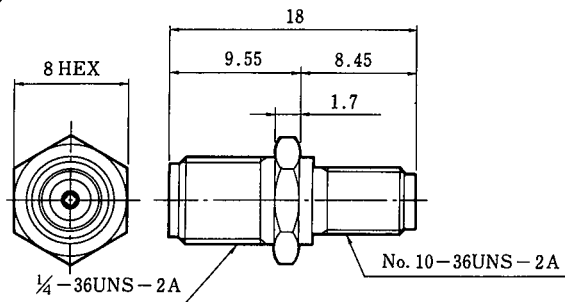

HRMJ-HRMMJ
CL311-0220-5