

阅读申明

- 1.本站收集的数据手册和产品资料都来自互联网，版权归原作者所有。如读者和版权方有任何异议请及时告之，我们将妥善解决。
- 2.本站提供的中文数据手册是英文数据手册的中文翻译，其目的是协助用户阅读，该译文无法自动跟随原稿更新，同时也可能存在翻译上的不当。建议读者以英文原稿为参考以便获得更精准的信息。
- 3.本站提供的产品资料，来自厂商的技术支持或者使用者的心得体会等，其内容可能存在描述上的差异，建议读者做出适当判断。
- 4.如需与我们联系，请发邮件到marketing@iczoom.com，主题请标有“数据手册”字样。

Read Statement

1. The datasheets and other product information on the site are all from network reference or other public materials, and the copyright belongs to the original author and original published source. If readers and copyright owners have any objections, please contact us and we will deal with it in a timely manner.
2. The Chinese datasheets provided on the website is a Chinese translation of the English datasheets. Its purpose is for reader's learning exchange only and do not involve commercial purposes. The translation cannot be automatically updated with the original manuscript, and there may also be improper translations. Readers are advised to use the English manuscript as a reference for more accurate information.
3. All product information provided on the website refer to solutions from manufacturers' technical support or users the contents may have differences in description, and readers are advised to take the original article as the standard.
4. If you have any questions, please contact us at marketing@iczoom.com and mark the subject with "Datasheets" .

NOMENCLATURE PLATING CODE	A STANDARD SIGNAL CONTACTS		B HIGH CONDUCTIVITY CONTACTS		CONTACT SIZE	C WIRE SIZE mm. Sq	A ±0.2	B ±0.2	C ±0.2	D ±0.2	E ±0.2	F ±0.2	G ±0.2	H ±0.3
	ORDER CODE		ORDER CODE											
	BULK PACK	LOOSE PIECE	BULK PACK	LOOSE PIECE										
Z	192990-2620	192990-1220	-	-	14-16	150-250	N/A	N/A	3.25 (2.25)	3.50	5.0	N/A	N/A	26.7
T	192990-2480	192990-1240	192900-0004	192900-0005										
Y	192900-0403	192900-0445	-	-										
D	121587-2000	121587-2008	-	-										
Z	192990-2630	192990-0100	-	-	18-16	0.75-150	3.70 (2.85)	3.60	2.87 (1.85)	2.90	5.6	3.55	1.3	27.1
T	192990-2490	192990-0060	192900-0000	192900-0002										
Y	192900-0404	192900-0446	-	-										
D	121587-2002	121587-2010	-	-										
Z	192990-2640	192922-1460	-	-	20-22	0.32-050	3.55 (2.95)	2.70	2.45 (1.95)	2.35	5.0	3.05	1.27	26.7
T	192990-2500	192990-0040	192900-0124	192900-0126										
Y	192900-0405	192900-0447	-	-										
D	121587-2004	121587-2012	-	-										
Z	192990-2650	192990-0080	-	-	24-26	0.14-0.25	3.25 (2.45)	2.15	2.10 (1.7)	1.75	5.00	3.05	1.27	26.7
T	192990-2510	192990-0020	192900-0120	192900-0122										
Y	192900-0406	192900-0448	-	-										
D	121587-2006	121587-2014	-	-										

F		G		H	
AUSGABE	AEEND.-NR.	AEENDERUNGS-BESCHREIBUNG		DATUM	NAME
J	4058W	Silberbeschichtung hinzu		08.03.2012	KS
K	4484W	Erlaeuterung hinzugefuegt		02.05.2013	SM
L	4696W	Alternative Kontaktformen hinzu		25.02.2014	JH

VEREINZELTE KONTAKTE
LOOSE PIECE

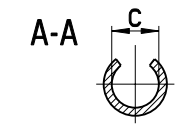

DRAHTCRIMP GR. 18-16
WIRE CRIMP SIZE 18-16

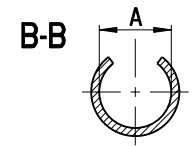

ISOLATIONSCRIMP GR. 18-16
INSULATION CRIMP SIZE 18-16

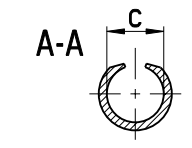

DRAHTCRIMP GR. 14
WIRE CRIMP SIZE 14

0.75 - 1.5 mm², 18-16 AWG
WIRE RANGE, WIRE SIZE

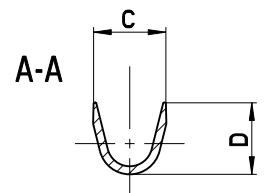
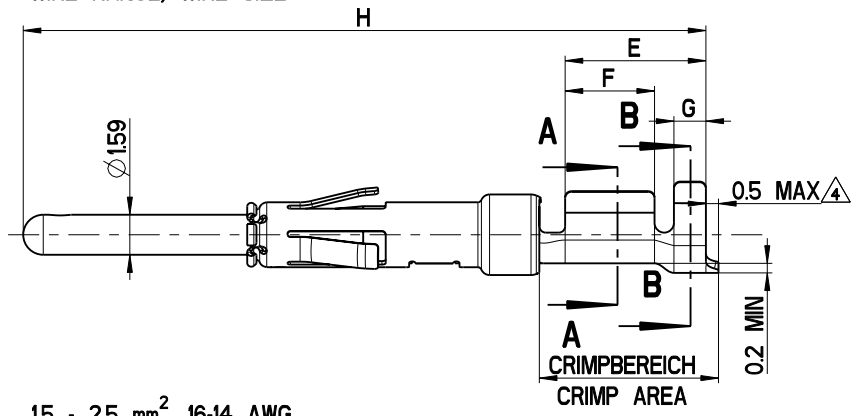

DRAHTCRIMP
WIRE CRIMP SIZE

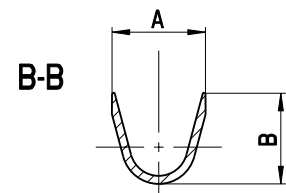

ISOLATIONSCRIMP
INSULATION CRIMP

1.5 - 2.5 mm², 16-14 AWG
WIRE RANGE, WIRE SIZE

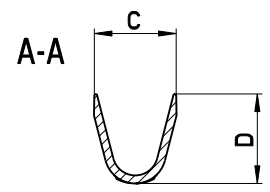
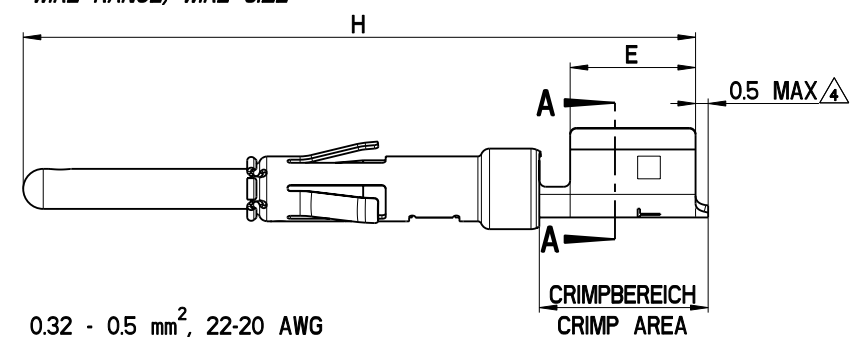

A-A

0.32 - 0.5 mm², 22-20 AWG
WIRE RANGE, WIRE SIZE
AND

0.14 - 0.25 mm², 26-24 AWG
WIRE RANGE, WIRE SIZE

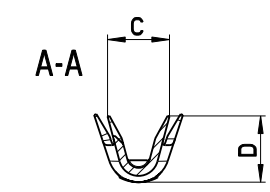
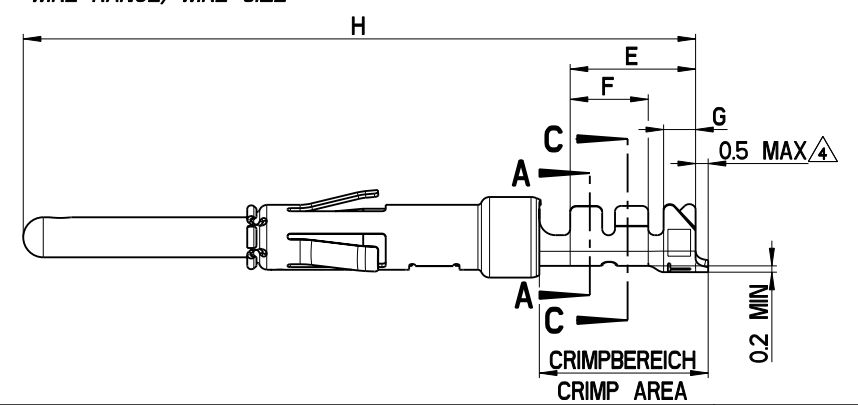

A-A

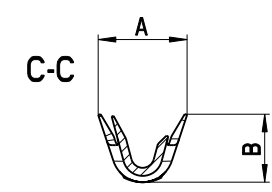

C-C

BEMERKUNGEN / NOTES

- VERPACKUNGSEINHEIT SPULE MIT 3000 KONTAKTEN
EINZELN VERPACKT IN TUETEN ZU 100 STUECK
BULK PACK - REEL OF 3000 CONTACTS
LOOSE PIECE - BAG OF 100 CONTACTS
- OBERFLAECHE / PLATING
Z : GOLD FLASH
T : TIN PLATING
Y : GOLD PLATING
D : SILVER PLATING

CRIMPBEREICH VERZINNT
CRIMP AREA TIN PLATED
- MASSE IN KLAMMERN FUER VEREINZELTE KONTAKTE
FIGURES IN BRACKET FOR LOOSE PIECES

KONTAKTE AUF SPULE MUESSEN UNTER BERUECKSICHTIGUNG
DIESES MASSES VOM SPULENBAND ABGELOEST WERDEN.
BULK PACK CONTACTS HAVE TO BE SEPARATED WITHIN THE SPECIFIED DIMENSION

WERKSTOFF: -		BEHANDLUNG: -		OBERFLAECHE: siehe Tabelle	
FREIEMASSE SIEHE TABELLE		WINKELTOLERANZ ± 0,5°		FUNKTIONSMASS ▲	
MASSE IN MM	> 0.3 ±0.05	> 6-30 ±0.1	RAUHIGKEIT Ra		SPC-MASS ▲
KANTEN UND ECKEN GEBROCHEN	> 3.6 ±0.05	> 30 ±0.2	Ra		
BEARBEITET	SEEBER	DATUM	19.05.1999	DATENNAME	74802-99
GEPRUEFT	EST	DATUM	11.01.2000	REFERENZ	-
FREIGABE	RFE	DATUM	11.01.2000	TEILNUMMER	-
ITT Cannon GmbH D-71384 Weinstadt Germany		MASSSTAB 5:1		BENENNUNG TWO PART TRIDENT SIGNAL CONTACTS	
© ALLE RECHTE VORBEHALTEN, AUCH FUER DEN FALL DER PATENTVERLEHUNG. JEDE MITTEILUNG AN DRITTE IST STRAFBAR		FORMAT	A2	SEITE	1 / 1
				ZEICHNUNGS-NUMMER	74802-99
				AENDERUNGSSTAND	L