

阅读申明

- 1.本站收集的数据手册和产品资料都来自互联网，版权归原作者所有。如读者和版权方有任何异议请及时告之，我们将妥善解决。
- 2.本站提供的中文数据手册是英文数据手册的中文翻译，其目的是协助用户阅读，该译文无法自动跟随原稿更新，同时也可能存在翻译上的不当。建议读者以英文原稿为参考以便获得更精准的信息。
- 3.本站提供的产品资料，来自厂商的技术支持或者使用者的心得体会等，其内容可能存在描述上的差异，建议读者做出适当判断。
- 4.如需与我们联系，请发邮件到marketing@iczoom.com，主题请标有“数据手册”字样。

Read Statement

1. The datasheets and other product information on the site are all from network reference or other public materials, and the copyright belongs to the original author and original published source. If readers and copyright owners have any objections, please contact us and we will deal with it in a timely manner.
2. The Chinese datasheets provided on the website is a Chinese translation of the English datasheets. Its purpose is for reader's learning exchange only and do not involve commercial purposes. The translation cannot be automatically updated with the original manuscript, and there may also be improper translations. Readers are advised to use the English manuscript as a reference for more accurate information.
3. All product information provided on the website refer to solutions from manufacturers' technical support or users the contents may have differences in description, and readers are advised to take the original article as the standard.
4. If you have any questions, please contact us at marketing@iczoom.com and mark the subject with "Datasheets" .

DESCRIPTION: **HIGH DENSITY MALE SOLDER CUP**

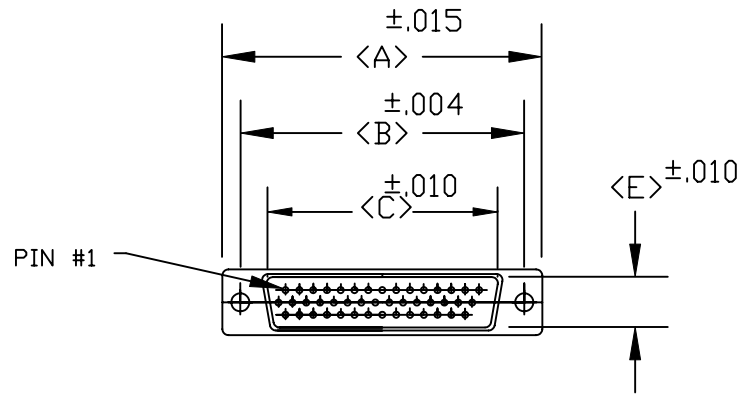

4 ROW

POS.	A	B	C	D	E	F	G
15	1.213	0.984	0.666	0.756	0.329	0.090	0.496
	30.80	24.99	16.92	19.20	8.36	2.29	12.60
26	1.543	1.312	0.994	1.091	0.329	0.090	0.496
	39.19	33.32	25.25	27.70	8.36	2.29	12.60
44	2.087	1.852	1.534	1.618	0.329	0.090	0.496
	53.00	47.04	38.96	41.10	8.36	2.29	12.60
62	2.732	2.500	2.181	2.256	0.329	0.095	0.496
	69.30	63.50	55.42	57.30	8.36	2.41	12.60
78	2.638	2.406	2.079	2.169	0.445	0.095	0.606
	67.00	61.00	52.80	55.10	11.30	2.41	15.39

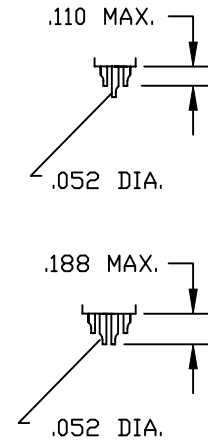
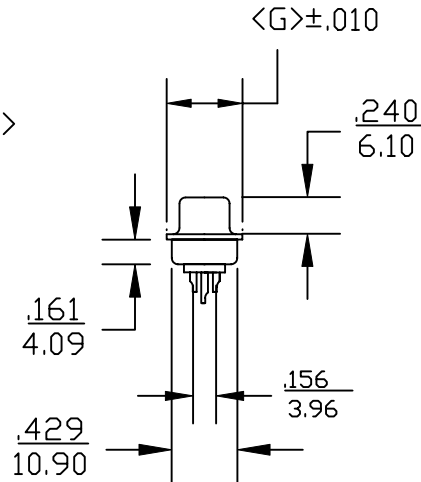
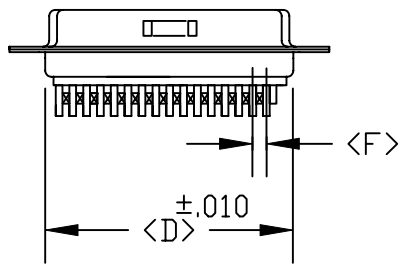

180-XXX-102-XX1

SERIES _____
 POSITIONS _____
 015
 026
 044
 062
 078
 GENDER _____
 1 = MALE
 2 = FEMALE
 TERMINATION _____
 0 = SOLDER CUP
 SHELL PLATING _____
 2 = TIN
 HARDWARE OPTIONS _____
 00 = NO HARDWARE (.120Ø HOLE)
 01 = 4-40 CLINCH-NUT .098" BOARD SIDE
 02 = 4-40 CLINCH NUT .250" BOARD SIDE
 03 = 4-40 CLINCH NUT .250" MATING SIDE
 91 = 4-40 SPACER/BOARD LOCK .225"
 PLATING OPTIONS _____
 1 = GOLD FLASH
 2 = 30 MICRO-INCH GOLD

ELECTRICALS:

CURRENT RATING: 2 AMPS
 CONTACT RESISTANCE: 15 mOHMS MAX.
 INSULATOR RESISTANCE: 1000MOHMS MIN.
 VOLTAGE: 500V FOR 1 MINUTE
 TEMPERATURE: -50° TO +100°

MATERIALS:

SHELL: STEEL, TIN PLATED
 INSULATOR: PBT - BLACK (UL-94-VO)

NOTE: WILL ACCEPT UPTO 24 AWG WIRE

	THESE DRAWINGS AND SPECIFICATIONS ARE THE PROPERTY OF NorComp AND SHALL NOT BE REPRODUCED, COPIED OR USED AS THE BASIS FOR THE MANUFACTURE OR SALE OF APPARATUS WITHOUT WRITTEN PERMISSION.		DRAWN: PAM JENKINS	DATE: 8-12-98
			CHECKED:	DATE:
<h1>NorComp</h1>			SCALE:	SHEET OF
			DWG NO.	
			180-XXX-102-XX1	

DESCRIPTION: CLINCH NUT HARDWARE

ALL CLINCH-NUTS ARE 4-40 INTERNAL THREADS

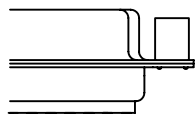

03X..... .250" (MATING SIDE) - CN8

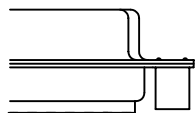

02X250" (BOARD SIDE) - CN2

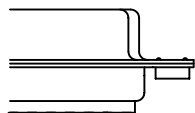

01X098" (BOARD SIDE) - CN1

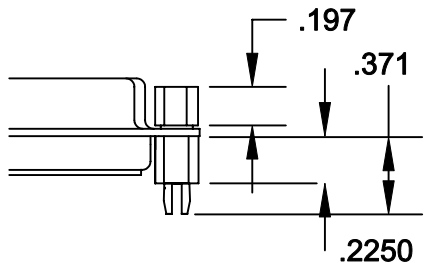

91X225" (BOARD SIDE) - .197 MATING SIDE - CN10/SFS0440

NOTE: 4-40 FEMALE SCREW LOCK IS REMOVABLE

	THESE DRAWINGS AND SPECIFICATIONS ARE THE PROPERTY OF NorComp AND SHALL NOT BE REPRODUCED, COPIED OR USED AS THE BASIS FOR THE MANUFACTURE OF SALE OF APPARATUS WITHOUT WRITTEN PERMISSION.		DRAWN: WAYNE ROBBINS	DATE: 8-23-98
	NorComp		CHECKED: PAM JENKINS	DATE: 8-24-98
SCALE:			SHEET 1 OF 1	REV 1
DWG NO.			CLINCH-NUT OPTIONS	