

阅读申明

- 1.本站收集的数据手册和产品资料都来自互联网，版权归原作者所有。如读者和版权方有任何异议请及时告之，我们将妥善解决。
- 2.本站提供的中文数据手册是英文数据手册的中文翻译，其目的是协助用户阅读，该译文无法自动跟随原稿更新，同时也可能存在翻译上的不当。建议读者以英文原稿为参考以便获得更精准的信息。
- 3.本站提供的产品资料，来自厂商的技术支持或者使用者的心得体会等，其内容可能存在描述上的差异，建议读者做出适当判断。
- 4.如需与我们联系，请发邮件到marketing@iczoom.com，主题请标有“数据手册”字样。

Read Statement

1. The datasheets and other product information on the site are all from network reference or other public materials, and the copyright belongs to the original author and original published source. If readers and copyright owners have any objections, please contact us and we will deal with it in a timely manner.
2. The Chinese datasheets provided on the website is a Chinese translation of the English datasheets. Its purpose is for reader's learning exchange only and do not involve commercial purposes. The translation cannot be automatically updated with the original manuscript, and there may also be improper translations. Readers are advised to use the English manuscript as a reference for more accurate information.
3. All product information provided on the website refer to solutions from manufacturers' technical support or users the contents may have differences in description, and readers are advised to take the original article as the standard.
4. If you have any questions, please contact us at marketing@iczoom.com and mark the subject with "Datasheets" .

DESCRIPTION: HIGH DENSITY VERTICAL LOW PROFILE/STAMPED

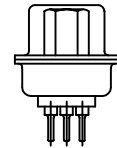
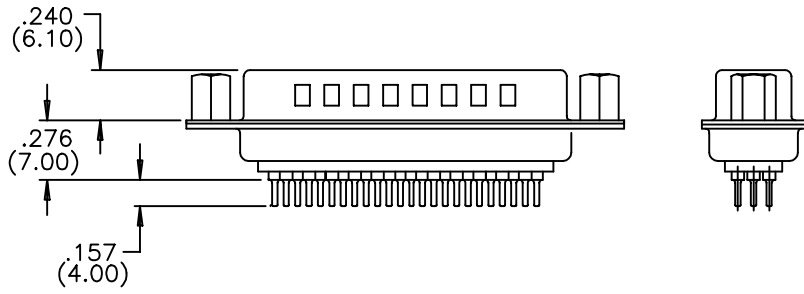
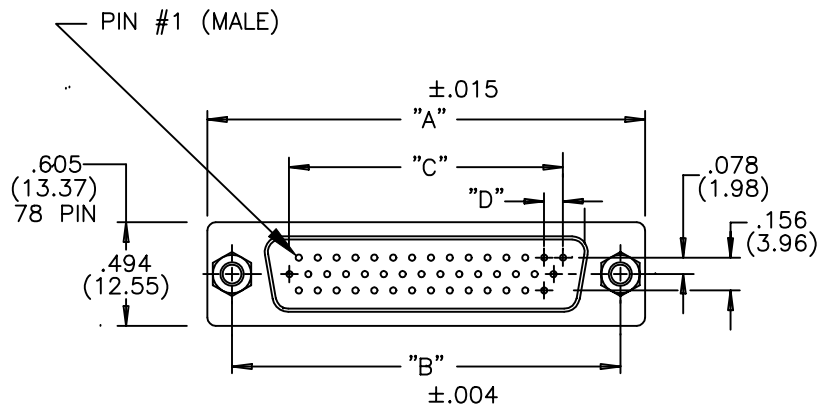

MATERIALS:

INSULATOR: THERMOPLASTIC POLYESTER, UL94V-0
CHEMICAL RESISTANCE, COLOR BLACK

SHELL: STEEL, NICKEL PLATED

CONTACT: MALE:BRASS; FEMALE: PHOSPHOR BRONZE
GOLD FLASH IN MATING AREA
TIN-LEAD PLATING ON TAIL ENDS

ELECTRICAL:

CURRENT RATING: 2 AMPERES
DIELECTRIC WITHSTANDING VOLTAGE:
1000VAC rms AT SEA LEVEL
INSULATION RESISTANCE: 5000 MEGOHMS MIN.
CONTACT RESISTANCE: 10 MILLIOHMS MAX.
WORKING TEMPERATURE: -55° TO +125° C

195-XXX-X13-XX1

SERIES _____
NUMBER OF CONTACTS _____
GENDER _____
1 = MALE
2 = FEMALE (NO GROUND INDENTS)
PC MOUNT _____
NICKEL SHELL _____
HARDWARE OPTIONS: _____
00 = .120 MOUNTING HOLE
55 = 4-40 INSERTS
03 = 4-40 HEX STANDOFFS
PLATING: _____
1 = GOLD FLASH

NUMBER OF CONTACTS	"A"	"B"	"C"	"D"
	Inch (mm)	Inch (mm)	Inch (mm)	Inch (mm)
15	1.214 (30.84)	.984 (24.99)	.405 (10.29)	.090 (2.29)
26	1.545 (39.24)	1.312 (33.32)	.765 (19.43)	.090 (2.29)
44	2.088 (53.04)	1.852 (47.04)	1.305 (33.15)	.090 (2.29)
62	2.730 (69.34)	2.500 (63.50)	1.948 (49.47)	.095 (2.41)
78	2.635 (66.93)	2.406 (61.11)	1.805 (45.85)	.095 (2.41)

	THESE DRAWINGS AND SPECIFICATIONS ARE THE PROPERTY OF NorComp AND SHALL NOT BE REPRODUCED, COPIED OR USED AS THE BASIS FOR THE MANUFACTURE OF SALE OF APPARATUS WITHOUT WRITTEN PERMISSION.		DRAWN: PAM JENKINS	DATE: 5-10-01
			CHECKED:	DATE:
<h1>NorComp</h1>		SCALE:	SHEET 1 OF 1	REV 2
		DWG NO. 195-XXX-113-XX1		

DESCRIPTION: HIGH DENSITY DIP SOLDER MALE FOOTPRINT

78 POSITION MALE

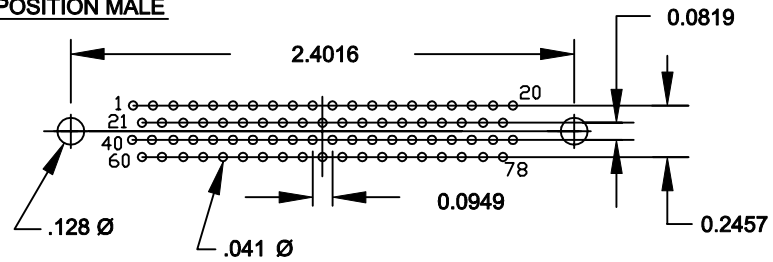

26 POSITION MALE

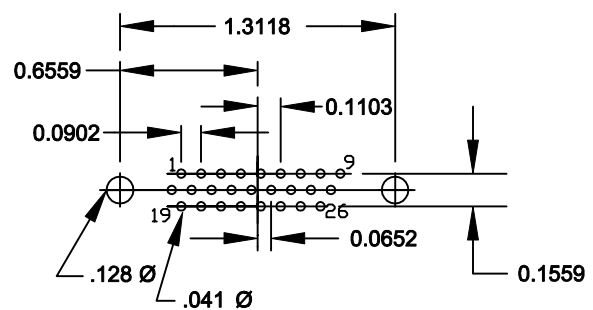

62 POSITION MALE

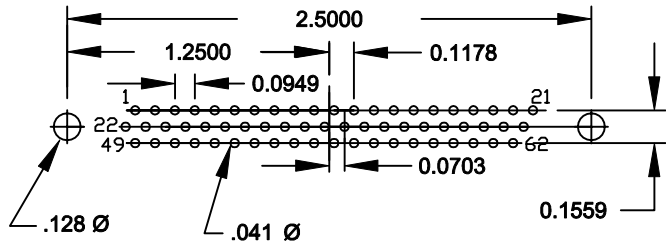

15 POSITION MALE

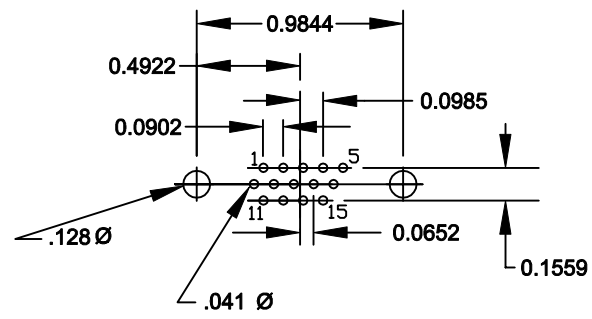

44 POSITION MALE

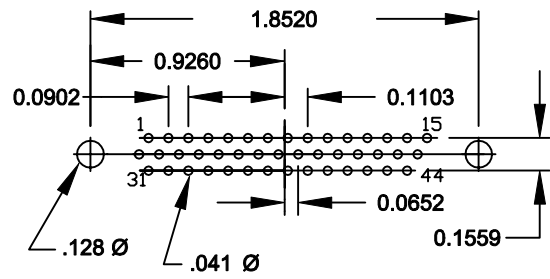

	THESE DRAWINGS AND SPECIFICATIONS ARE THE PROPERTY OF NorComp AND SHALL NOT BE REPRODUCED, COPIED OR USED AS THE BASIS FOR THE MANUFACTURE OF SALE OF APPARATUS WITHOUT WRITTEN PERMISSION.		DRAWN: PAM JENKINS	DATE: 10-29-01
			CHECKED:	DATE:
<h1>NorComp</h1>		SCALE:	SHEET 1 OF 1	REV 2
		DWG NO. HIGH DENSITY VERTICAL MALE FOOTPRINT		