

## 阅读申明

- 1.本站收集的数据手册和产品资料都来自互联网，版权归原作者所有。如读者和版权方有任何异议请及时告之，我们将妥善解决。
- 2.本站提供的中文数据手册是英文数据手册的中文翻译，其目的是协助用户阅读，该译文无法自动跟随原稿更新，同时也可能存在翻译上的不当。建议读者以英文原稿为参考以便获得更精准的信息。
- 3.本站提供的产品资料，来自厂商的技术支持或者使用者的心得体会等，其内容可能存在描述上的差异，建议读者做出适当判断。
- 4.如需与我们联系，请发邮件到marketing@iczoom.com，主题请标有“数据手册”字样。

## Read Statement

1. The datasheets and other product information on the site are all from network reference or other public materials, and the copyright belongs to the original author and original published source. If readers and copyright owners have any objections, please contact us and we will deal with it in a timely manner.
2. The Chinese datasheets provided on the website is a Chinese translation of the English datasheets. Its purpose is for reader's learning exchange only and do not involve commercial purposes. The translation cannot be automatically updated with the original manuscript, and there may also be improper translations. Readers are advised to use the English manuscript as a reference for more accurate information.
3. All product information provided on the website refer to solutions from manufacturers' technical support or users the contents may have differences in description, and readers are advised to take the original article as the standard.
4. If you have any questions, please contact us at marketing@iczoom.com and mark the subject with "Datasheets" .

# Single Slot Connector for PC Card Type III

## IC7 Series

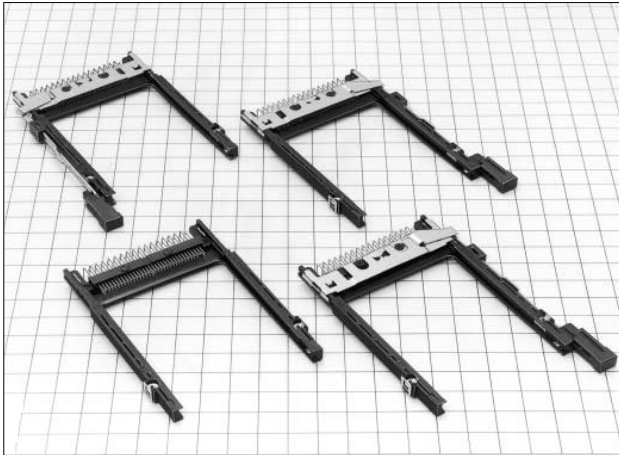

### ■ Features

#### 1. PC Card Standard compliant:

Type I, type II and type III cards are covered. Terminals for grounding are provided.

#### 2. Space saving and Lightweight

Connector height is minimized to 5.4mm, and weight is 12.5g.

#### 3. Eject mechanism

Hirose's unique ejection mechanism provides an higher degree of card ejection over existing products.

### ■ Product Specifications

Rating	Current rating	0.5 A	Operating temperature range	-55°C to +85°C (Note 1)	Storage temperature range	-40°C to +70°C (Note 2)
	Voltage rating	125V AC	Operating humidity range (No condensation)	Relative humidity 95% max.	Storage humidity range	Relative humidity 40% to 70%

Item	Specification	Conditions
1. Insulation resistance	1000 M ohms min.	500 V DC
2. Withstanding voltage	No flashover or insulation breakdown	500 V AC / 1 minute
3. Contact resistance	40 m ohms max. (Initial value)	1mA
4. Vibration	No electrical discontinuity of 100ns or more	Frequency: 10 to 2000 Hz, full amplitude of 1.52 mm or acceleration of 147m/s <sup>2</sup> , 4 hours in each of the 3 directions
5. Humidity (Steady state)	Insulation resistance: 100 M ohms min.	96 hours at temperature of 40°C and humidity of 90% to 95%
6. Temperature cycle	No damage, cracks, or parts looseness	Temperature: -55°C → +15°C to +35°C → +85°C → +15°C to +35°C Time: 30 → 5 max. → 30 → 5 max. (Minutes) 5 cycles
7. Durability (insertion/ withdrawal)	Contact resistance: 20 m ohms max. from initial value	10000 cycles at 400 to 600 cycles per hour
8. Resistance to soldering heat	No deformation of the insulator parts affecting performance	Manual soldering: 300°C for 3 seconds

Note 1: Includes temperature rise caused by current flow.

Note 2: The term "storage" refers to products stored for long period of time prior to mounting and use. Operating Temperature Range and Humidity range covers non- conducting condition of installed connectors in storage, shipment or during transportation.

### ■ Material

Part		Material	Finish	Remarks
Insulator	Connector	PBT	Color: Black	UL94V-0
	Eject Button	PA	Color: Black	UL94V-0
Contact	Connector	Brass	Contact area: gold plating	—
	Terminals for grounding		Phosphor bronze	Gold plating
Eject metal fitting		Stainless steel	—	—
Locking pins		Phosphor bronze	Solder plating	—
Nuts		Steel	Nickel plating	—

## ■ Ordering Information

1 **IC7** - 2 **68** 3 **PDR** - 4 **1.27** 5 **DS** - 6 **EJR**

<b>1</b>	Series Name : IC7
<b>2</b>	Number of contacts : 68
<b>3</b>	Board mounting type PD : Standard PDR : Reverse
<b>4</b>	Contact pitch : 1.27mm
<b>5</b>	Board Mounting Type DS : Right angle Dip
<b>6</b>	Ejector type No letter : Without Eject Button EJR : Right Eject Button EJL : Left Eject Button

## ◆ Examples of Connector Mounting

### Standard type

● IC7-68PD-1.27DS-EJL

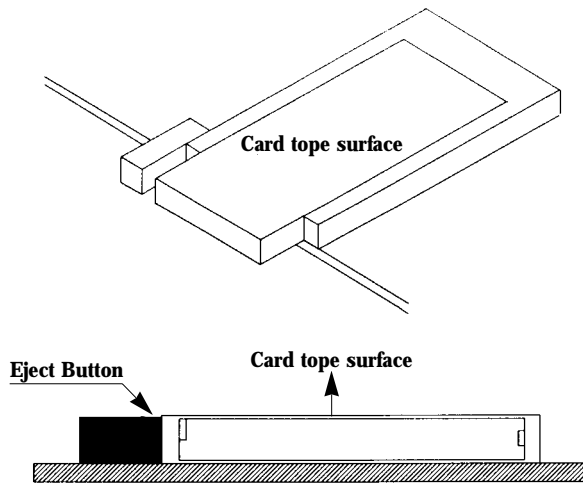

● IC7-68PD-1.27DS-EJR

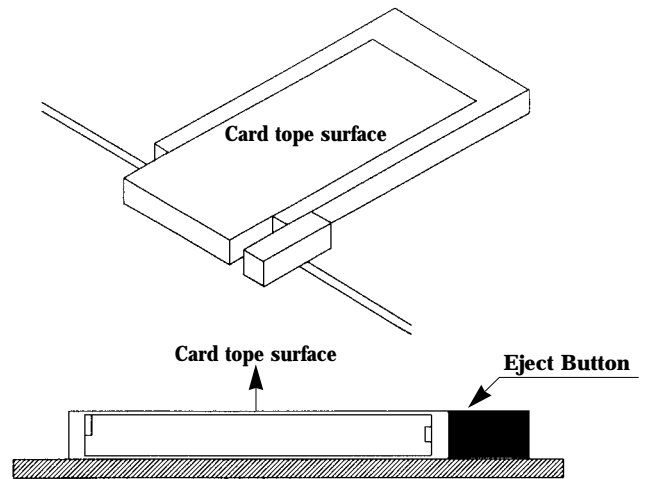

### Reverse type

● IC7-68PDR-1.27DS-EJL

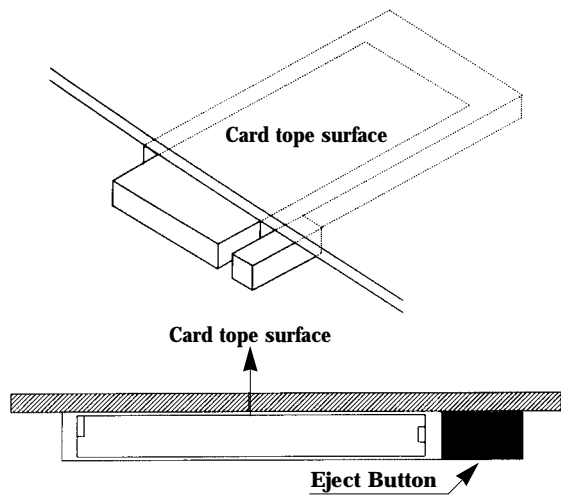

● IC7-68PDR-1.27DS-EJR

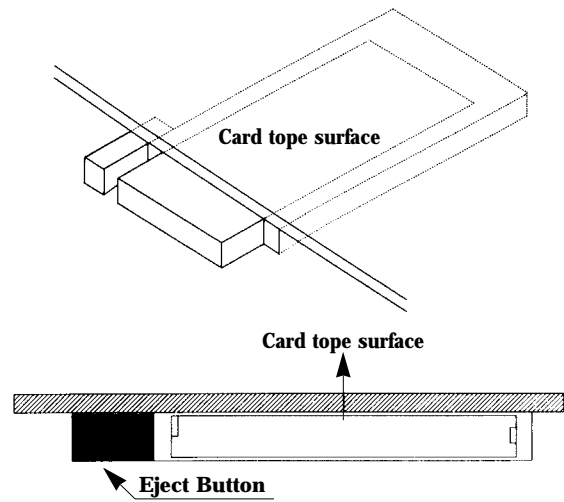

# Single Slot Connector

●Right Eject Button

●Standard type, Reverse type

**Standard**  
IC7-68PD-1.27DS-EJR  
CL640-0401-0

**Reverse** ◻4  
IC7-68PDR-1.27DS-EJR  
CL640-0402-2

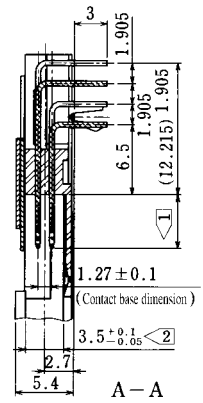
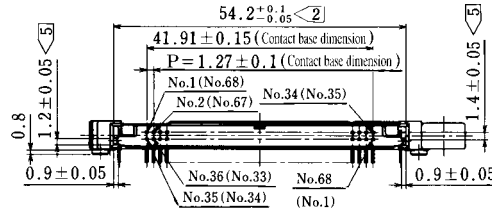
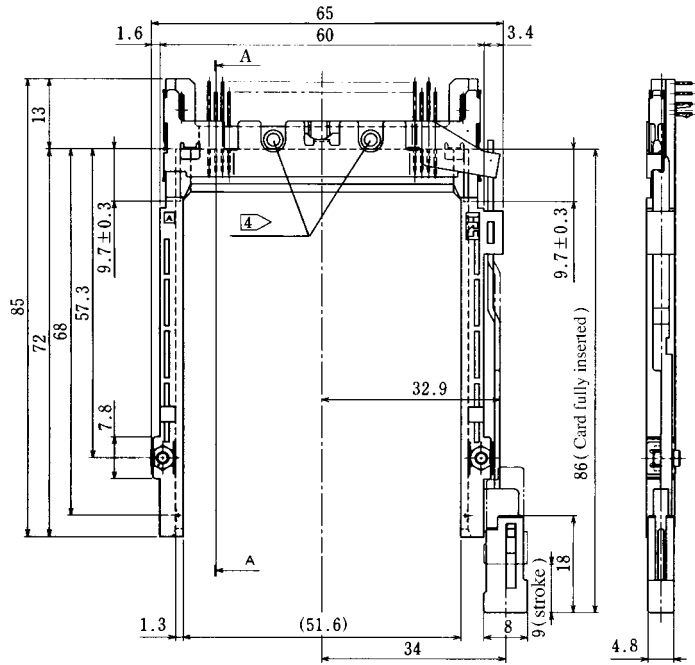

Table 1 ◻1

Contact No.	Contact Length
1, 17, 34, 35, 51, 68	5.0 ±0.1
36, 67	3.5 ±0.1
Other than above	4.25±0.1

Note ◻1 The contacts length is indicated in Table 1.

◻2 The applicable range of indicated dimensions (54.2<sup>+0.1</sup><sub>-0.05</sub>, 3.5<sup>+0.1</sup><sub>-0.05</sub>) are taken as 10mm from the bottom.

◻3 The terminal for grounding should be securely fastened from the bottom surface of the board using a screw (M2×0.4), flat washer and lock washer.

◻4 Pay attention to the Contact No. since the reverse type is marked "R". See the numbers in parentheses ( ) for the Contact No. of the reverse type.

◻5 The guide groove dimensions of the reverse type are left-right reversed.

## PCB mounting pattern

## Example of Screw Fastening (Recommendation)

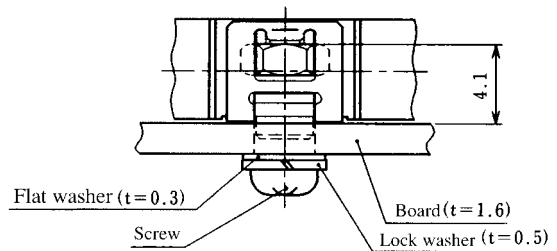
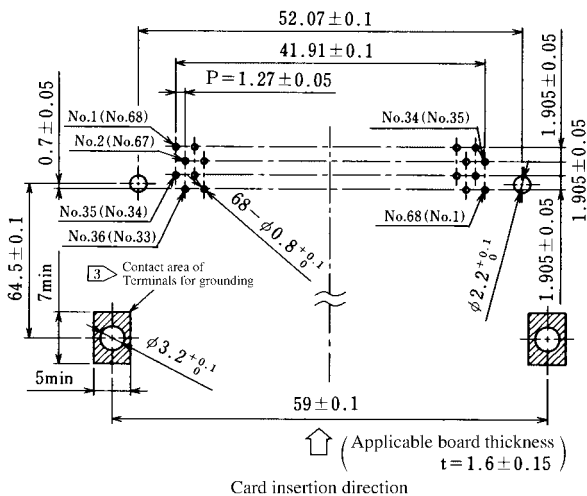

# Single Slot Connector

●Left Eject Button

●Standard type, Reverse type

**Standard**  
 IC7-68PD-1.27DS-EJL  
 CL640-0403-5  
**Reverse** ④  
 IC7-68PDR-1.27DS-EJL  
 CL640-0404-8

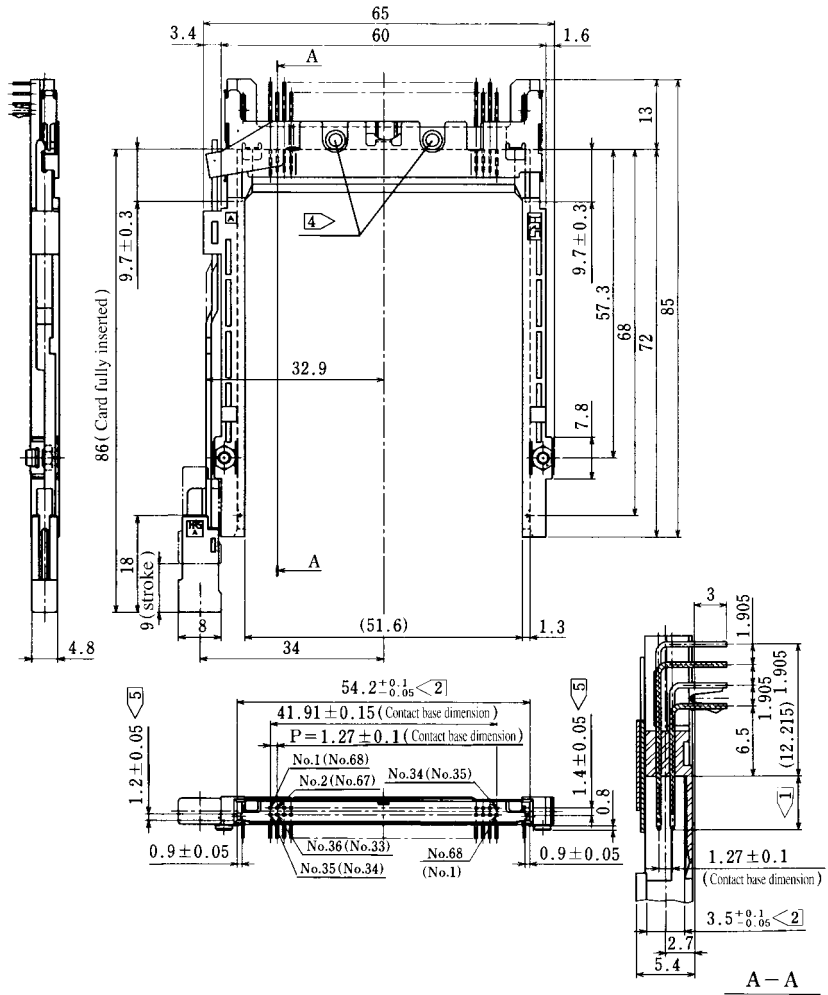

Table 1 ①

Contact No.	Contact Length
1, 17, 34, 35, 51, 68	5.0 ±0.1
36, 67	3.5 ±0.1
Other than above	4.25±0.1

Note ① The contacts length is indicated in Table 1.

② The applicable range of indicated dimensions ( $54.2^{+0.1}_{-0.05}$ ,  $3.5^{+0.1}_{-0.05}$ ) are taken as 10mm from the bottom.

③ The terminal for grounding should be securely fastened from the bottom surface of the board using a screw (M2×0.4), flat washer and lock washer.

④ Pay attention to the Contact No. since the reverse type is marked "R". See the numbers in parentheses ( ) for the Contact No. of the reverse type.

⑤ The guide groove dimensions of the reverse type are left-right reversed.

## PCB mounting pattern

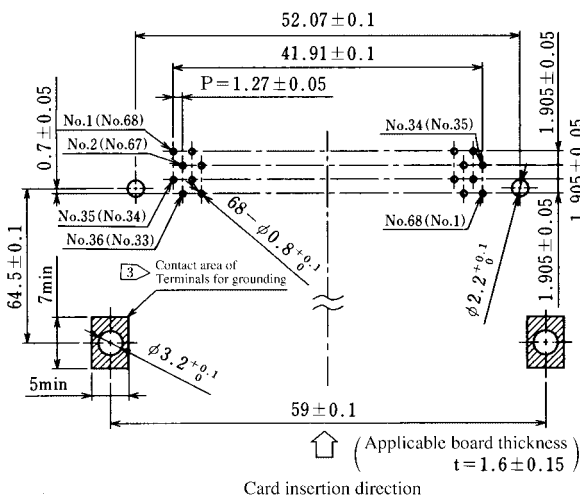

## Example of Screw Fastening (Recommendation)

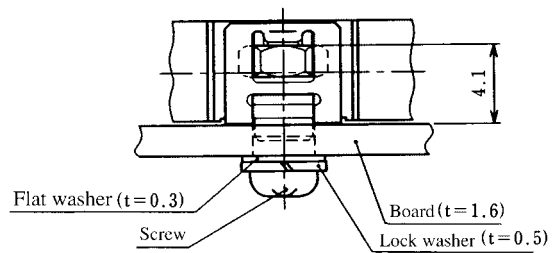

# Single Slot Connector

Without Eject Button

Standard type

IC7-68PD-1.27DS  
CL640-0405-0

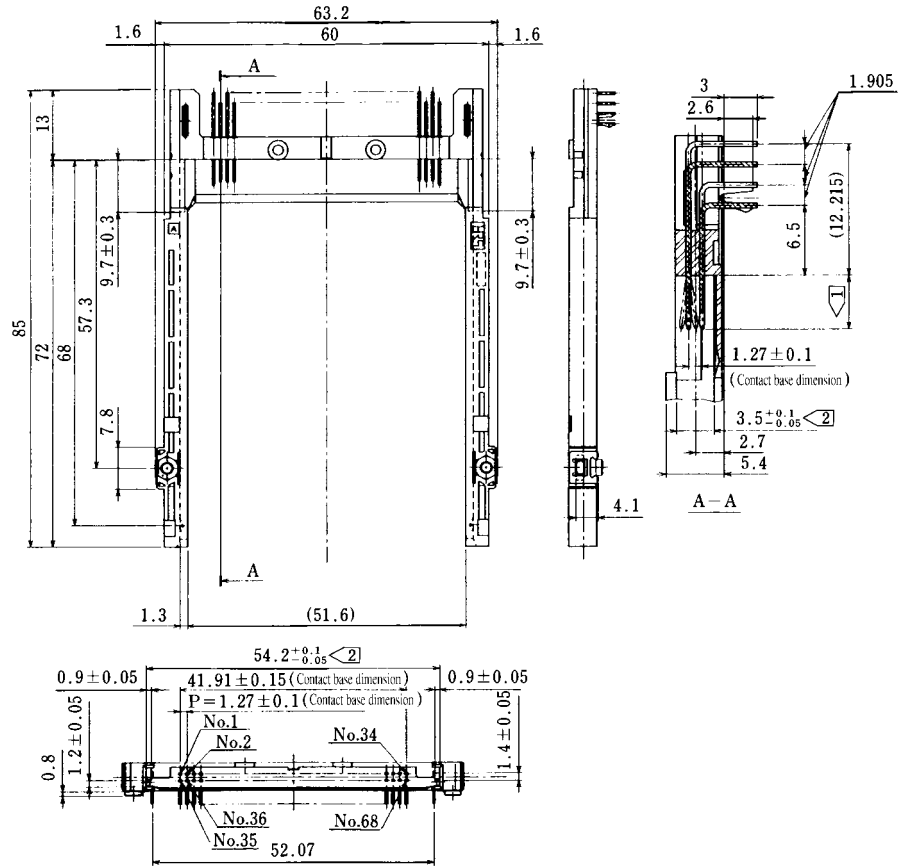

Table 1 ①

Contact No.	Contact Length
1, 17, 34, 35, 51, 68	5.0 ± 0.1
36, 67	3.5 ± 0.1
Other than above	4.25 ± 0.1

Note ① The contacts length is indicated in Table 1.

② The applicable range of indicated dimensions (54.2<sup>+0.1</sup><sub>-0.05</sub>, 3.5<sup>+0.1</sup><sub>-0.05</sub>) are taken as 10mm from the bottom.

③ The terminal for grounding should be securely fastened from the bottom surface of the board using a screw (M2×0.4), flat washer and lock washer.

## PCB mounting pattern

## Example of Screw Fastening (Recommendation)

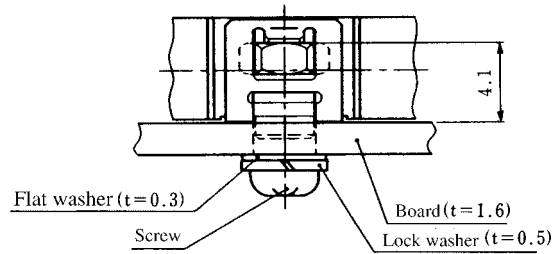
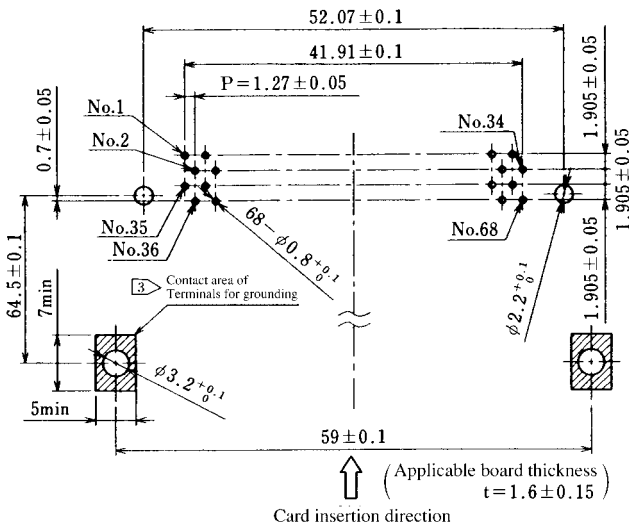

## NOTES :

Ruled lines for taking notes.