

阅读申明

- 1.本站收集的数据手册和产品资料都来自互联网，版权归原作者所有。如读者和版权方有任何异议请及时告之，我们将妥善解决。
- 2.本站提供的中文数据手册是英文数据手册的中文翻译，其目的是协助用户阅读，该译文无法自动跟随原稿更新，同时也可能存在翻译上的不当。建议读者以英文原稿为参考以便获得更精准的信息。
- 3.本站提供的产品资料，来自厂商的技术支持或者使用者的心得体会等，其内容可能存在描述上的差异，建议读者做出适当判断。
- 4.如需与我们联系，请发邮件到marketing@iczoom.com，主题请标有“数据手册”字样。

Read Statement

1. The datasheets and other product information on the site are all from network reference or other public materials, and the copyright belongs to the original author and original published source. If readers and copyright owners have any objections, please contact us and we will deal with it in a timely manner.
2. The Chinese datasheets provided on the website is a Chinese translation of the English datasheets. Its purpose is for reader's learning exchange only and do not involve commercial purposes. The translation cannot be automatically updated with the original manuscript, and there may also be improper translations. Readers are advised to use the English manuscript as a reference for more accurate information.
3. All product information provided on the website refer to solutions from manufacturers' technical support or users the contents may have differences in description, and readers are advised to take the original article as the standard.
4. If you have any questions, please contact us at marketing@iczoom.com and mark the subject with "Datasheets" .

Single Slot SMT Connectors For Card-Bus Based PC Cards

IC11S Series

PC Card Standard Compliant

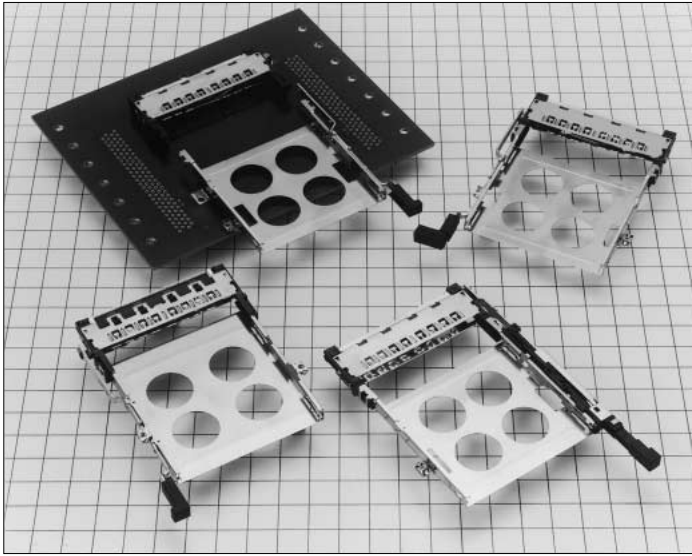

Reduced height : 5.6mm high



■ Features

1. PC Card Standard compliant:

- Grounding is required to meet the high speed signal requirements of the PC card standard. Grounding reliability is achieved with a grounding plate and 8 grounding contacts.
- Type I , type II and type III cards are covered.
- Terminals for ground clipping are provided.

2. Space saving

Smaller size reduces occupied area on PC boards as compared to previous products.

3. Reduced Height:

Connector height is minimized to 5.6mm, making possible thinner product designs.

4. Eject mechanism with high-level functionality

Hirose Electric's original ejection mechanism provides an higher degree of card ejection over existing products. This improves the operational qualities of card removal. (Patents pending)

5. Wide Variety of Options Available

- Standard type mounts to the top of the PC board and reverse type mounts on the underside of the board
- Three types of eject buttons; rigid, flexible and POP-UP. All types can be installed on the right or left side of the ejector.
- Available with standoff to utilize space under the connector for mounting other parts.

6. Light-weight

Weight of 12.7g for normal button type helps achieve the reduced weight required in today's products.

Wide variety of options

(1) Board Mounting

- ① Standard type
- ② Reverse type

(2) Types of eject button

- ① Rigid button
- ② Foldering button
- ③ Pop-up button

(3) Position of eject buttons

- ① Right
- ② Left

(4) Standoffs

- ① None
- ② 2.2mm



■Product Specifications

| | | | | | | |
|---------|----------------|---------|-----------------------|---|---------------------|------------------------|
| Ratings | Current rating | 0.5A | Operating temperature | -55°C to +85°C(Note.1) | Storage temperature | -40°C to +70°C(Note.2) |
| | Voltage rating | 125V AC | Operating humidity | Relativehumidity 95% max. (With no dew-fall) | Storage humidity | 40% to 70%(Note.2) |

| Item | Specification | Conditions |
|--|---|--|
| 1.Insulation resistance | 1000M ohms min. | 500V DC |
| 2.Withstanding voltage | No flashover or insulation breakdown. | 500V AC |
| 3.Contact resistance | 60m ohms max. (initial value) | 1mA |
| 4.Vibration | No electrical discontinuity of 100ns or more | Frequency: 10 to 2000 Hz, full amplitude of 1.52 mm or acceleration of 147 m/s ² (peak), 4 hours in each of the 3 directions. |
| 5.Humidity (Steady state) | Insulation resistance: 100M ohms min. | 96 hours at temperature of 40°C and humidity of 90% to 95% |
| 6.Temperature cycle | Insulation resistance: 100M ohms min. | (-55°C:30min.→+5°C to 35°C:MAX 5min→85°C:30min→+5-35°C:MAX 5min.) 5 cycles |
| 7.Durability (Insertion/withdrawal) | Variations from initial contact resistance: 20m ohms max. | 10000 cycles at 400 to 600 cycles per hour |
| 8.Resistance to Soldering heat | No deformation of components affecting performance. | Reflow: At the recommended temperature profile Manual soldering: 300°C for 3 seconds |

Note 1: Includes temperature rise caused by current flow.

Note 2: The term "storage" refers to products stored for long period of time prior to mounting and use. Operating Temperature Range and Humidity range covers non- conducting condition of installed connectors in storage, shipment or during transportation.

■Material

SMT unit

| Parts | | Material | Finish | Remarks |
|----------------------|------------------------|-----------------|---|---------|
| Insulator | | PPS | Black | UL94V-0 |
| Contact | Card connected section | Brass | Contact section: gold plating Lead section: solder plating | — |
| | Ground plate | Phosphor bronze | Contact section: gold plating Lead section: solder plating | — |
| Eject metal fittings | | Stainless steel | — | — |

Guide unit

| Item | | Material | Finish | Remarks | |
|--------------|-----------------------|-----------------|-----------------|---------------|---------|
| Guide plate | | Stainless steel | — | — | |
| Push rod | | Stainless steel | — | — | |
| Eject Button | Rigid button type | resin section | PBT | Color : Black | UL94V-0 |
| | | resin section | PBT | Color : Black | UL94V-0 |
| | Foldering button type | spring | Stainless steel | — | — |
| | | spring pin | Stainless steel | — | — |
| | | resin section | PBT | Color : Black | UL94V-0 |
| | POP-UP type | frame metal | Stainless steel | — | — |
| | | spring | Steel | — | — |
| pin | | Brass | Nickel plating | — | |
| Nut | | Steel | — | M2X0.4 | |

■ Ordering Information

SMT Unit

IC11S A - 68 PLR - 1.27SF - EJ R
 ① ② ③ ④ ⑤ ⑥ ⑦

| | |
|--|---|
| ① Series name : IC11S | ⑤ 1.27SF : 1.27mm pitch SMT connector |
| ② Standoff type Blank : none A : 2.2mm | ⑥ With ejector EJ : with ejector |
| ③ Number of contacts : 68 | |
| ④ Board Mounting Type: PL : standard type PLR : reverse type | ⑦ Eject button positions R : right L : left |

Guide Unit

IC11S A - BUR - FEJ R
 ⑧ ⑨ ⑩ ⑪ ⑫

| | |
|---|---|
| ⑧ Series name : IC11S | ⑪ Eject button type EJ : rigid button FEJ : Foldering button PEJ : POP-UP button |
| ⑨ Standoff type Blank: none A : 2.2mm | |
| ⑩ Board Mounting Type BD : standard type BUR : reverse type | ⑫ Eject button positions R : right L : left |

(Note.) IC11S Series will be used in combination of SMT unit with guide unit. When using, please select the same type for the following items. Please note that other combinations cannot be used.

- Series name (① ⇔ ⑧)
- Standoff (② ⇔ ⑨)
- Board-installed type (④ ⇔ ⑩)
- Eject button positions (⑦ ⇔ ⑫)

Standard

Right rigid button type

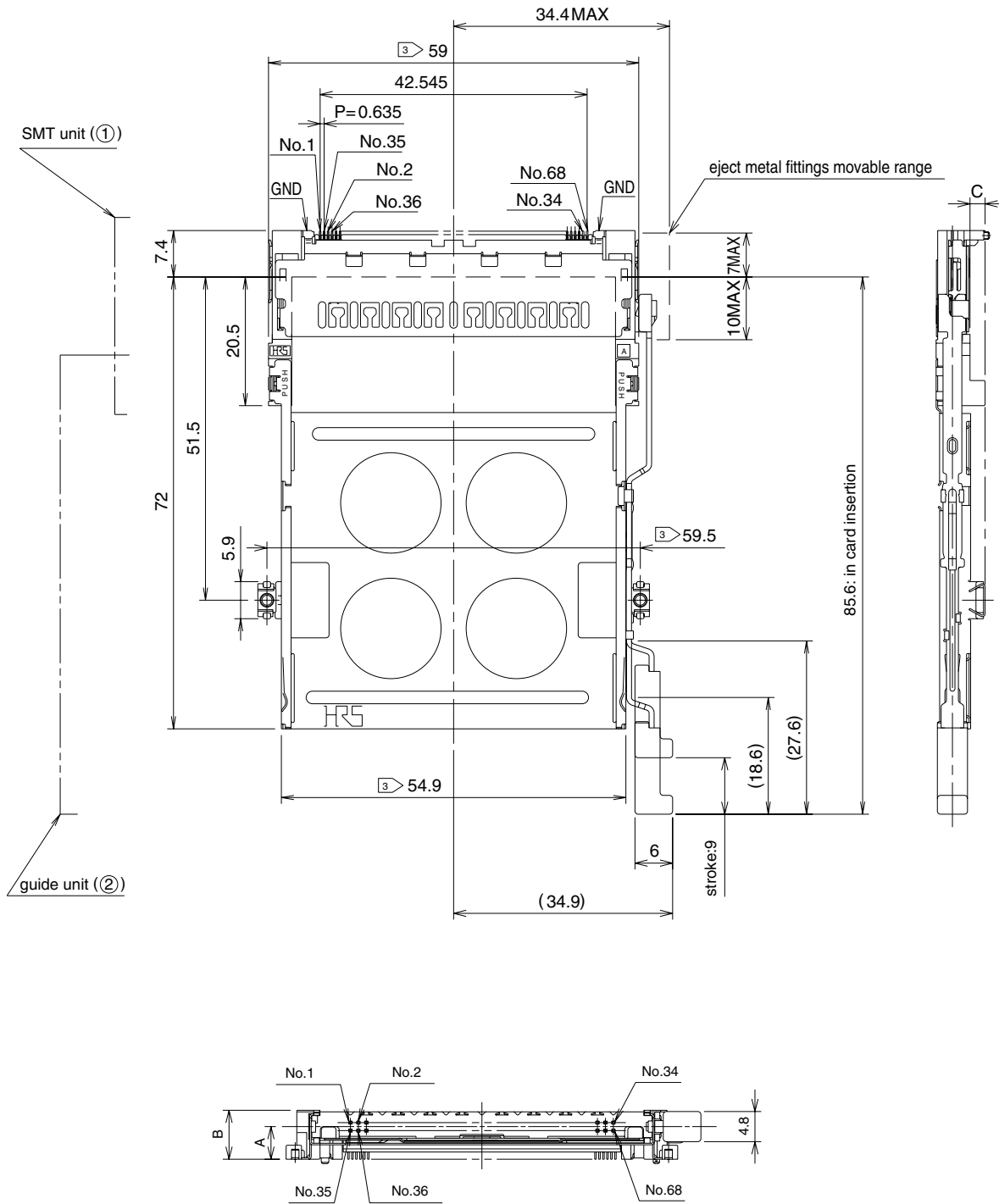

| Standoff type | ①SMT unit | | ②Guide unit | | A (mm) | B (mm) | C (mm) | Weight (g) |
|---------------|------------------------|------------|---------------|------------|--------|--------|--------|------------|
| | Part Number | CL No. | Part Number | CL No. | | | | |
| none | IC11S-68PL-1.27SF-EJR | 640-1007-3 | IC11S-BD-EJR | 640-1071-2 | 3 | 5.6 | 0.1 | 12.7 |
| 2.2mm | IC11SA-68PL-1.27SF-EJR | 640-1009-9 | IC11SA-BD-EJR | 640-1073-8 | 5.2 | 7.8 | 2.3 | 13.1 |

Note.1) This figure illustrates grouping of SMT unit(①) and guide unit(②) together.

Note.2) Dimensions for card fitting are in accordance with "PC Card Standard".

Note.3) Indicated dimensions are symmetrical to the center of the card insertion slot.

Standard
Left rigid button type

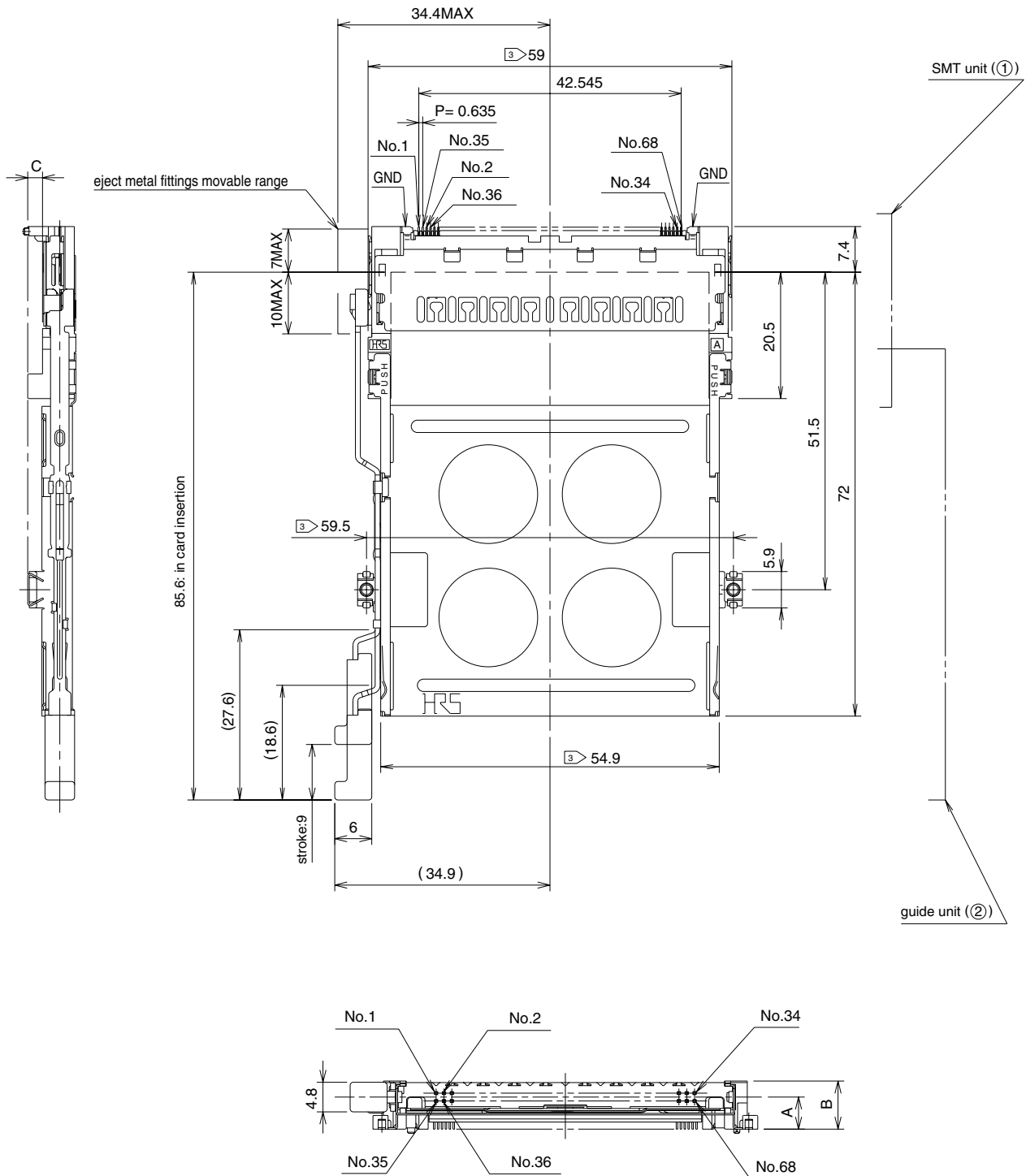

| Standoff type | ①SMT unit | | ②Guide unit | | A (mm) | B (mm) | C (mm) | Weight (g) |
|---------------|------------------------|------------|---------------|------------|--------|--------|--------|------------|
| | Part Number | CL No. | Part Number | CL No. | | | | |
| none | IC11S-68PL-1.27SF-EJL | 640-1008-6 | IC11S-BD-EJL | 640-1072-5 | 3 | 5.6 | 0.1 | 12.7 |
| 2.2mm | IC11SA-68PL-1.27SF-EJL | 640-1010-8 | IC11SA-BD-EJL | 640-1074-0 | 5.2 | 7.8 | 2.3 | 13.1 |

Note.1) This figure illustrates grouping of SMT unit(①) and guide unit(②) together.

Note.2) Dimensions for card fitting are in accordance with "PC Card Standard".

Note.3) Indicated dimensions are symmetrical to the center of the card insertion slot.

Standard

Right flexible button type

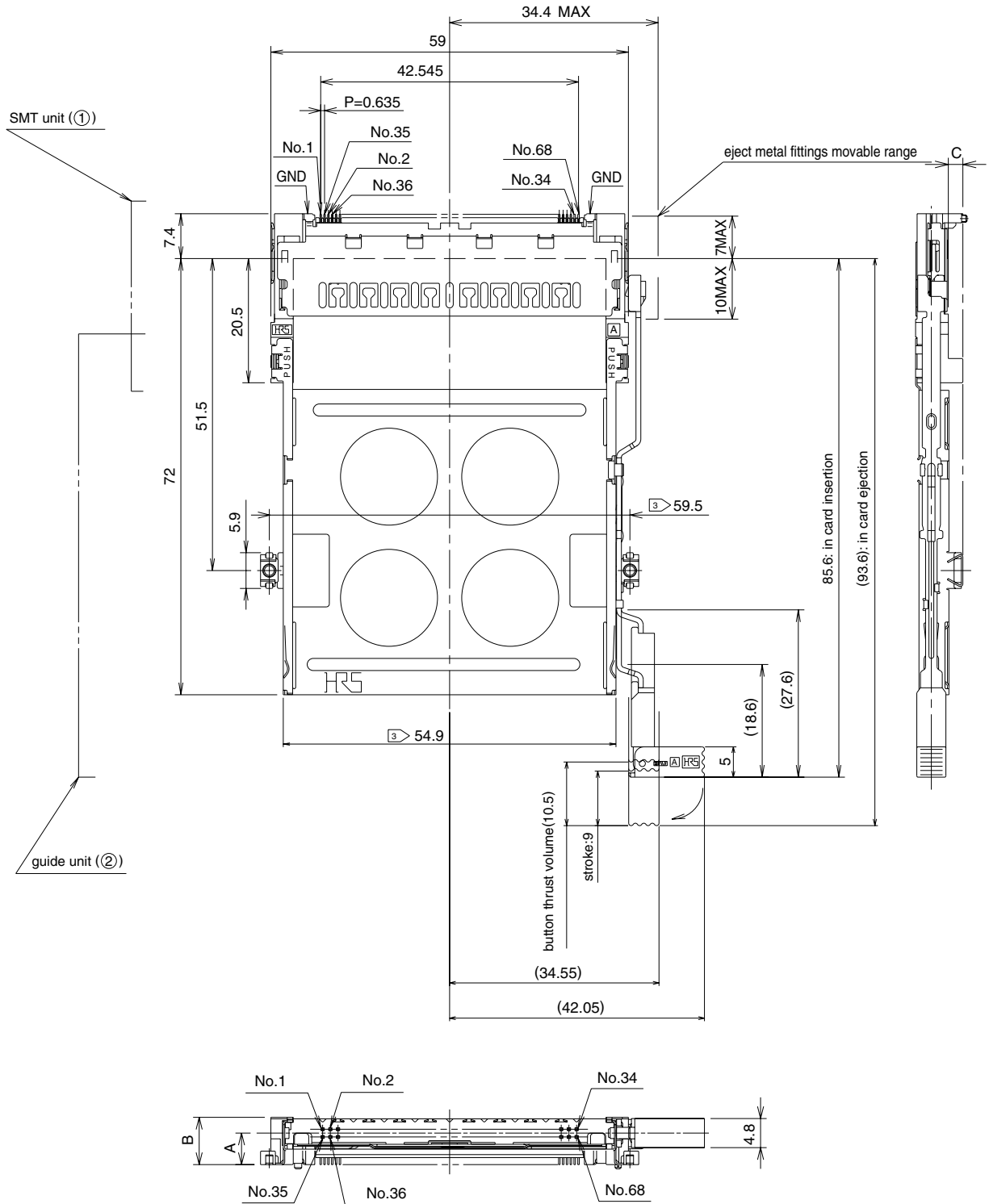

| Standoff type | ①SMT unit | | ②Guide unit | | A (mm) | B (mm) | C (mm) | Weight (g) |
|---------------|------------------------|------------|----------------|------------|--------|--------|--------|------------|
| | Part Number | CL No. | Part Number | CL No. | | | | |
| none | IC11S-68PL-1.27SF-EJR | 640-1007-3 | IC11S-BD-FEJR | 640-1075-3 | 3 | 5.6 | 0.1 | 13.1 |
| 2.2mm | IC11SA-68PL-1.27SF-EJR | 640-1009-9 | IC11SA-BD-FEJR | 640-1077-9 | 5.2 | 7.8 | 2.3 | 13.5 |

Note.1) This figure illustrates grouping of SMT unit(①) and guide unit(②) together.

Note.2) Dimensions for card fitting are in accordance with "PC Card Standard".

Note.3) Indicated dimensions are symmetrical to the center of the card insertion slot.

Standard

Left flexible. button type

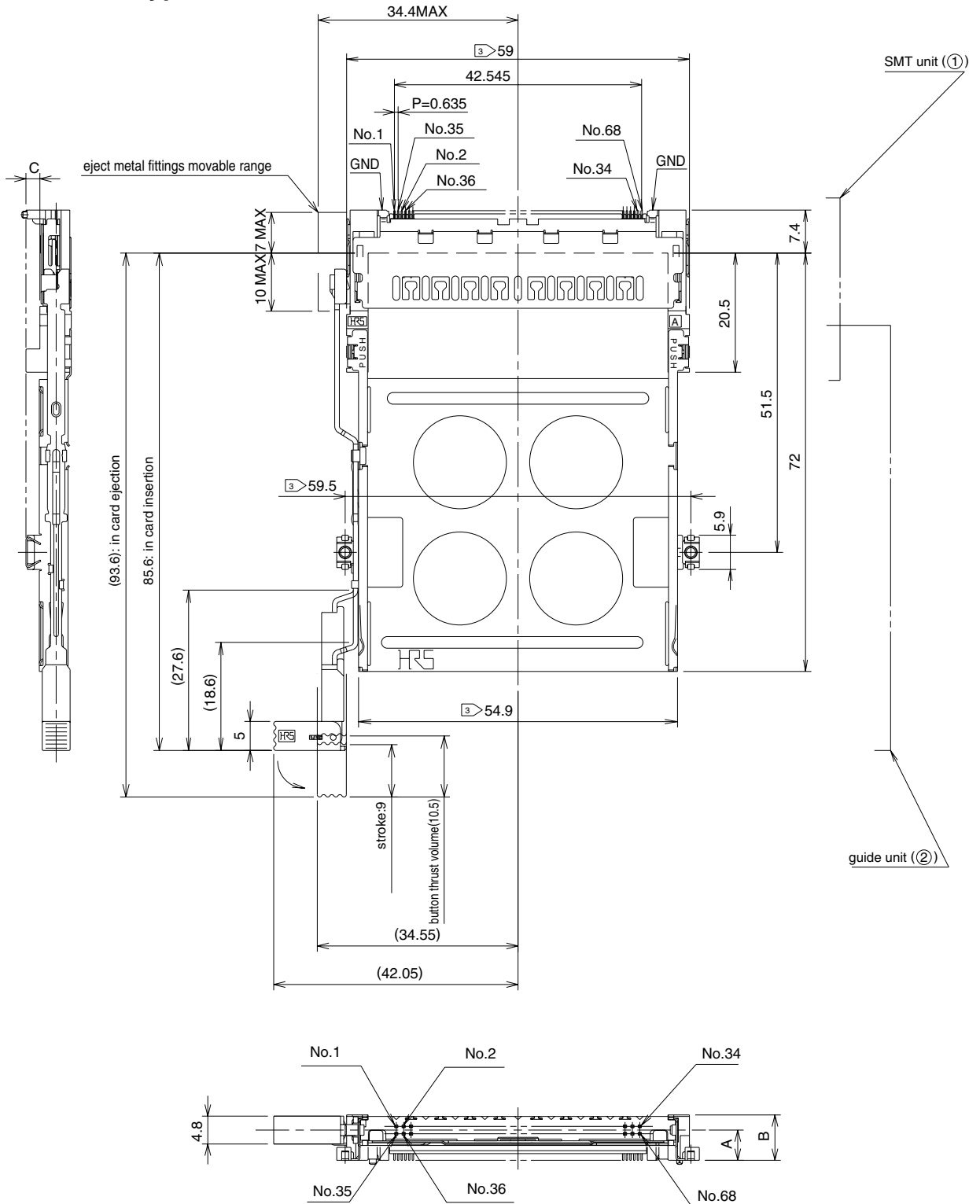

| Standoff type | ①SMT unit | | ②Guide unit | | A (mm) | B (mm) | C (mm) | Weight (g) |
|---------------|------------------------|------------|----------------|------------|--------|--------|--------|------------|
| | Part Number | CL No. | Part Number | CL No. | | | | |
| none | IC11S-68PL-1.27SF-EJL | 640-1008-6 | IC11S-BD-FEJL | 640-1076-6 | 3 | 5.6 | 0.1 | 13.1 |
| 2.2mm | IC11SA-68PL-1.27SF-EJL | 640-1010-8 | IC11SA-BD-FEJL | 640-1078-1 | 5.2 | 7.8 | 2.3 | 13.5 |

Note.1) This figure illustrates grouping of SMT unit(①) and guide unit(②) together.

Note.2) Dimensions for card fitting are in accordance with "PC Card Standard".

Note.3) Indicated dimensions are symmetrical to the center of the card insertion slot.

Standard

Right POP-UP button type

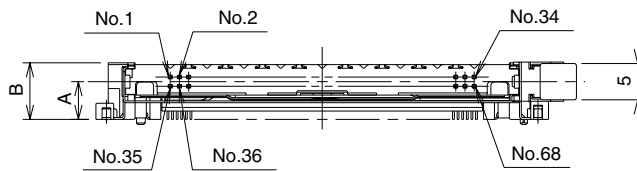
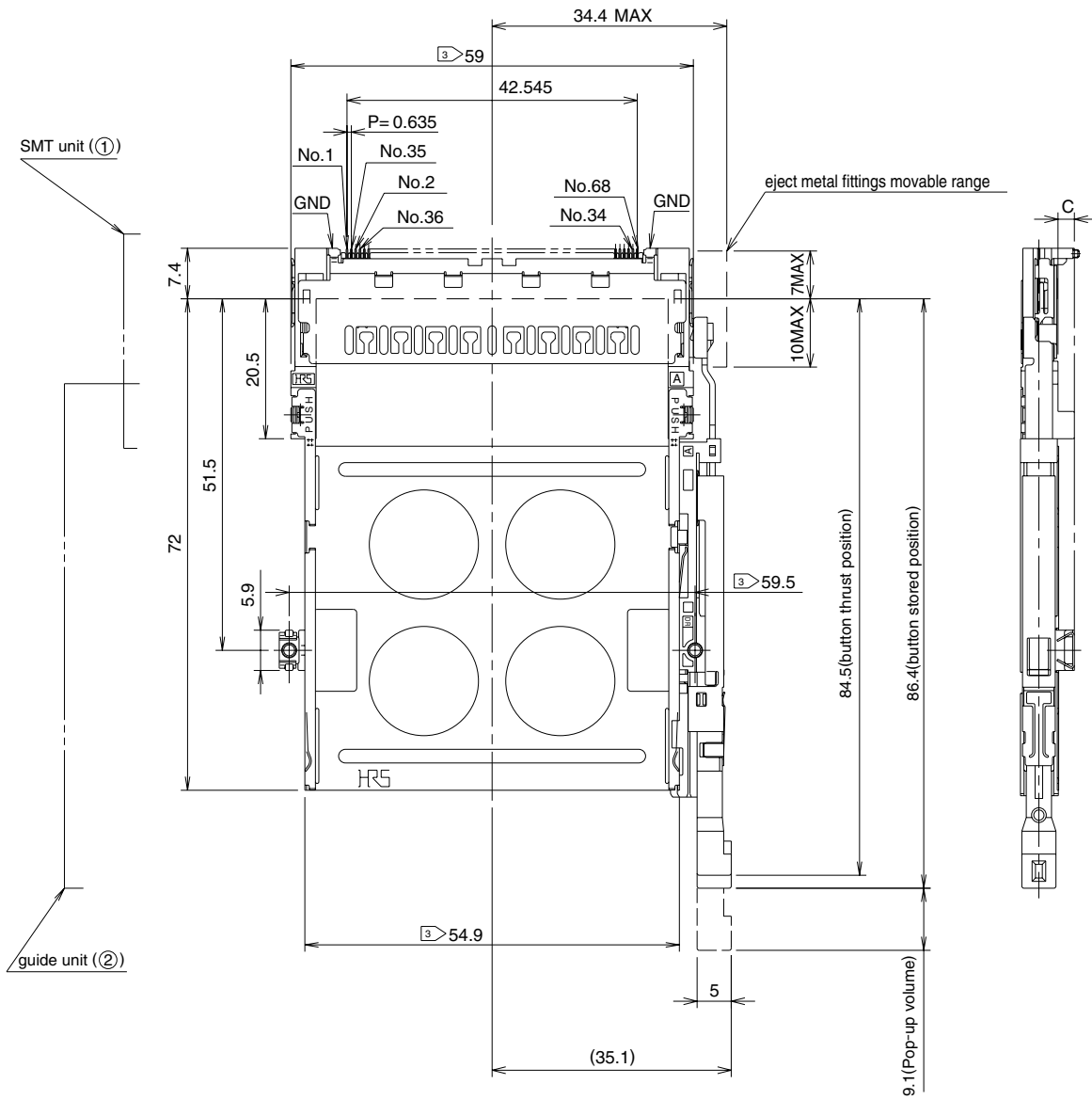

| Standoff type | ①SMT unit | | ②Guide unit | | A (mm) | B (mm) | C (mm) | Weight (g) |
|---------------|------------------------|------------|----------------|------------|--------|--------|--------|------------|
| | Part Number | CL No. | Part Number | CL No. | | | | |
| none | IC11S-68PL-1.27SF-EJR | 640-1007-3 | IC11S-BD-PEJR | 640-1081-6 | 3 | 5.7 | 0.1 | 14.7 |
| 2.2mm | IC11SA-68PL-1.27SF-EJR | 640-1009-9 | IC11SA-BD-PEJR | 640-1083-1 | 5.2 | 7.9 | 2.3 | 15.1 |

Note.1) This figure illustrates grouping of SMT unit(①) and guide unit(②) together.

Note.2) Dimensions for card fitting are in accordance with "PC Card Standard".

Note.3) Indicated dimensions are symmetrical to the center of the card insertion slot.

Standard

Left POP-UP button type

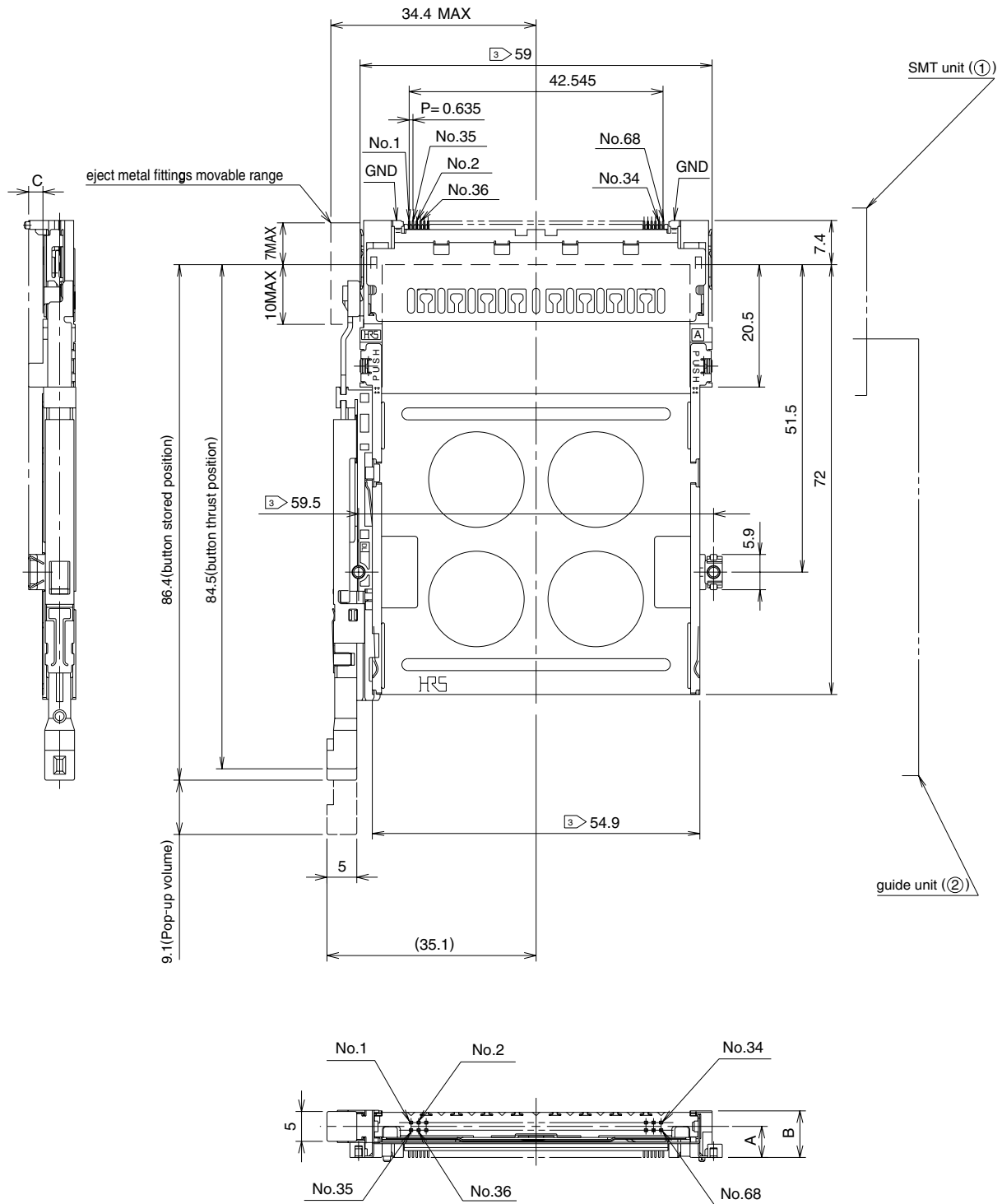

| Standoff type | ①SMT unit | | ②Guide unit | | A (mm) | A (mm) | C (mm) | Weight (g) |
|---------------|------------------------|------------|----------------|------------|--------|--------|--------|------------|
| | Part Number | CL No. | Part Number | CL No. | | | | |
| none | IC11S-68PL-1.27SF-EJL | 640-1008-6 | IC11S-BD-PEJL | 640-1082-9 | 3 | 5.7 | 0.1 | 14.7 |
| 2.2mm | IC11SA-68PL-1.27SF-EJL | 640-1010-8 | IC11SA-BD-PEJL | 640-1084-4 | 5.2 | 7.9 | 2.3 | 15.1 |

Note.1) This figure illustrates grouping of SMT unit(①) and guide unit(②) together.

Note.2) Dimensions for card fitting are in accordance with "PC Card Standard".

Note.3) Indicated dimensions are symmetrical to the center of the card insertion slot.

Reverse

Right rigid button type

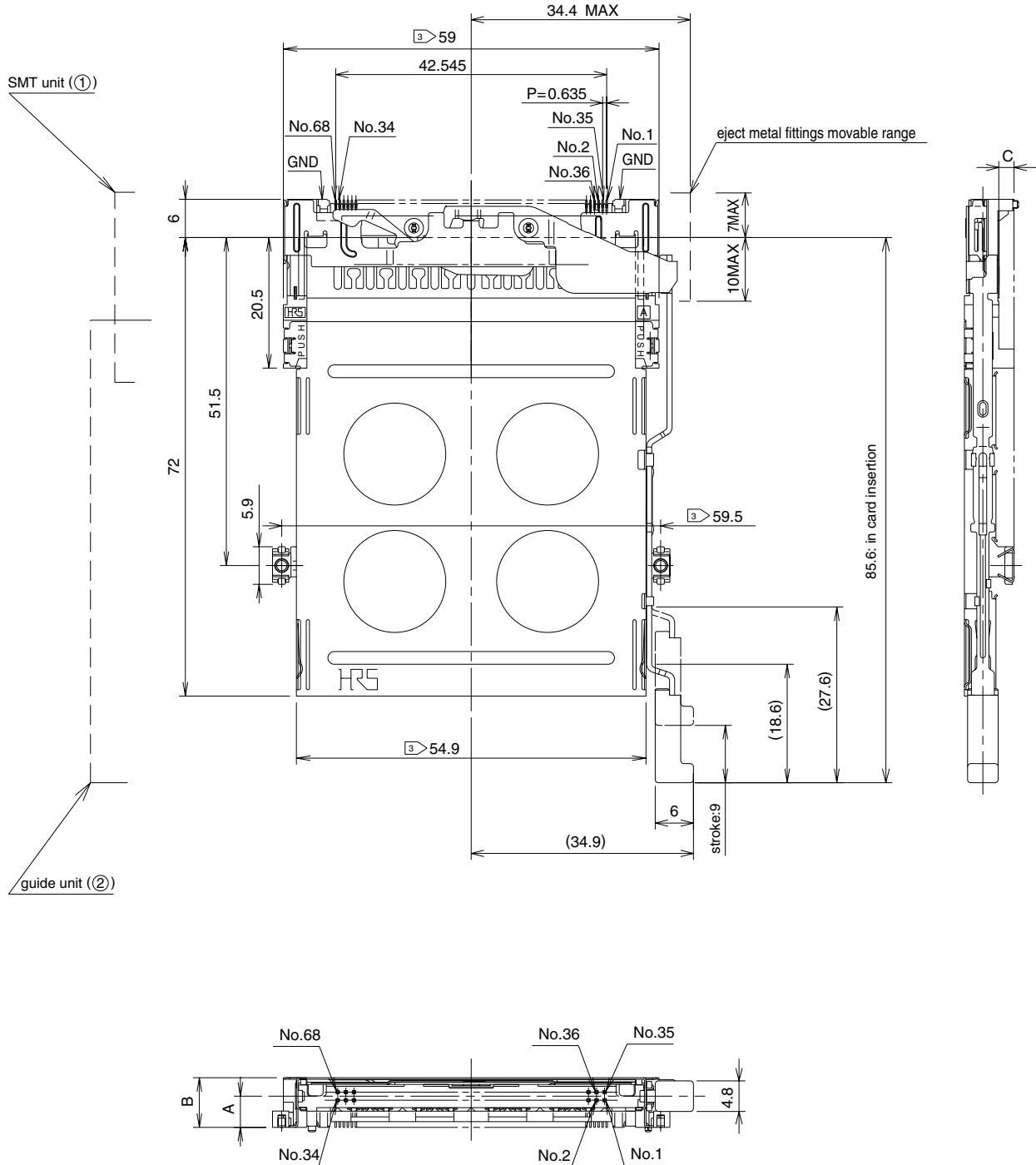

| Standoff type | ①SMT unit | | ②Guide unit | | A (mm) | B (mm) | C (mm) | Weight (g) |
|---------------|-------------------------|------------|----------------|------------|--------|--------|--------|------------|
| | Part Number | CL No. | Part Number | CL No. | | | | |
| none | IC11S-68PLR-1.27SF-EJR | 640-1003-2 | IC11S-BUR-EJR | 640-1055-6 | 2.7 | 5.6 | 0.1 | 13.1 |
| 2.2mm | IC11SA-68PLR-1.27SF-EJR | 640-1005-8 | IC11SA-BUR-EJR | 640-1057-1 | 4.9 | 7.8 | 2.3 | 13.6 |

Note.1) This figure illustrates grouping of SMT unit(①) and guide unit(②) together.

Note.2) Dimensions for card fitting are in accordance with "PC Card Standard".

Note.3) Indicated dimensions are symmetrical to the center of the card insertion slot.

Reverse

Left rigid button type

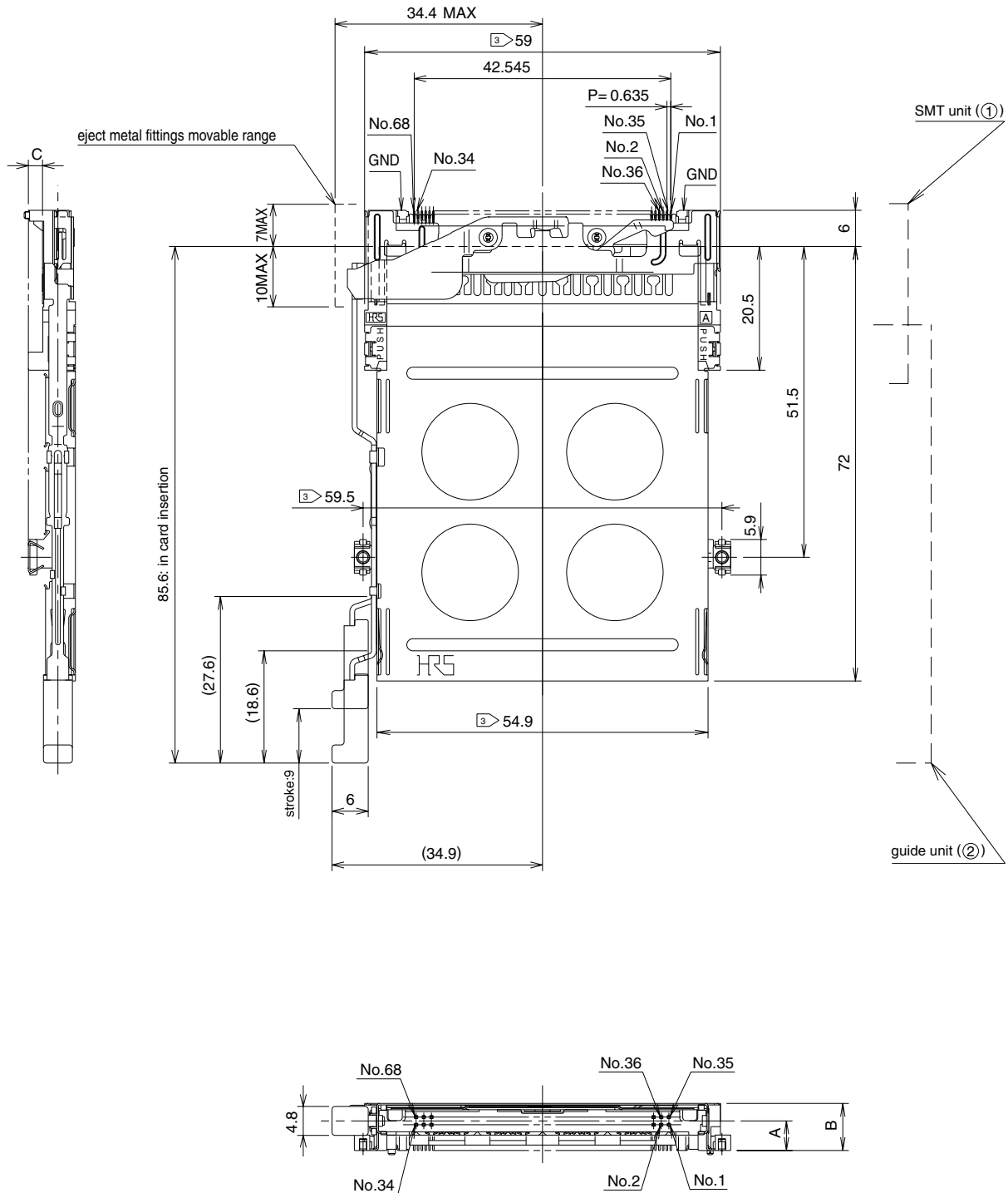

| Standoff type | ①SMT unit | | ②Guide unit | | A (mm) | B (mm) | C (mm) | Weight (g) |
|---------------|-------------------------|------------|----------------|------------|--------|--------|--------|------------|
| | Part Number | CL No. | Part Number | CL No. | | | | |
| none | IC11S-68PLR-1.27SF-EJL | 640-1004-5 | IC11S-BUR-EJL | 640-1056-9 | 2.7 | 5.6 | 0.1 | 13.1 |
| 2.2mm | IC11SA-68PLR-1.27SF-EJL | 640-1006-0 | IC11SA-BUR-EJL | 640-1058-4 | 4.9 | 7.8 | 2.3 | 13.6 |

Note.1) This figure illustrates grouping of SMT unit(①) and guide unit(②) together.

Note.2) Dimensions for card fitting are in accordance with "PC Card Standard".

Note.3) Indicated dimensions are symmetrical to the center of the card insertion slot.

Reverse

Left flexible button type

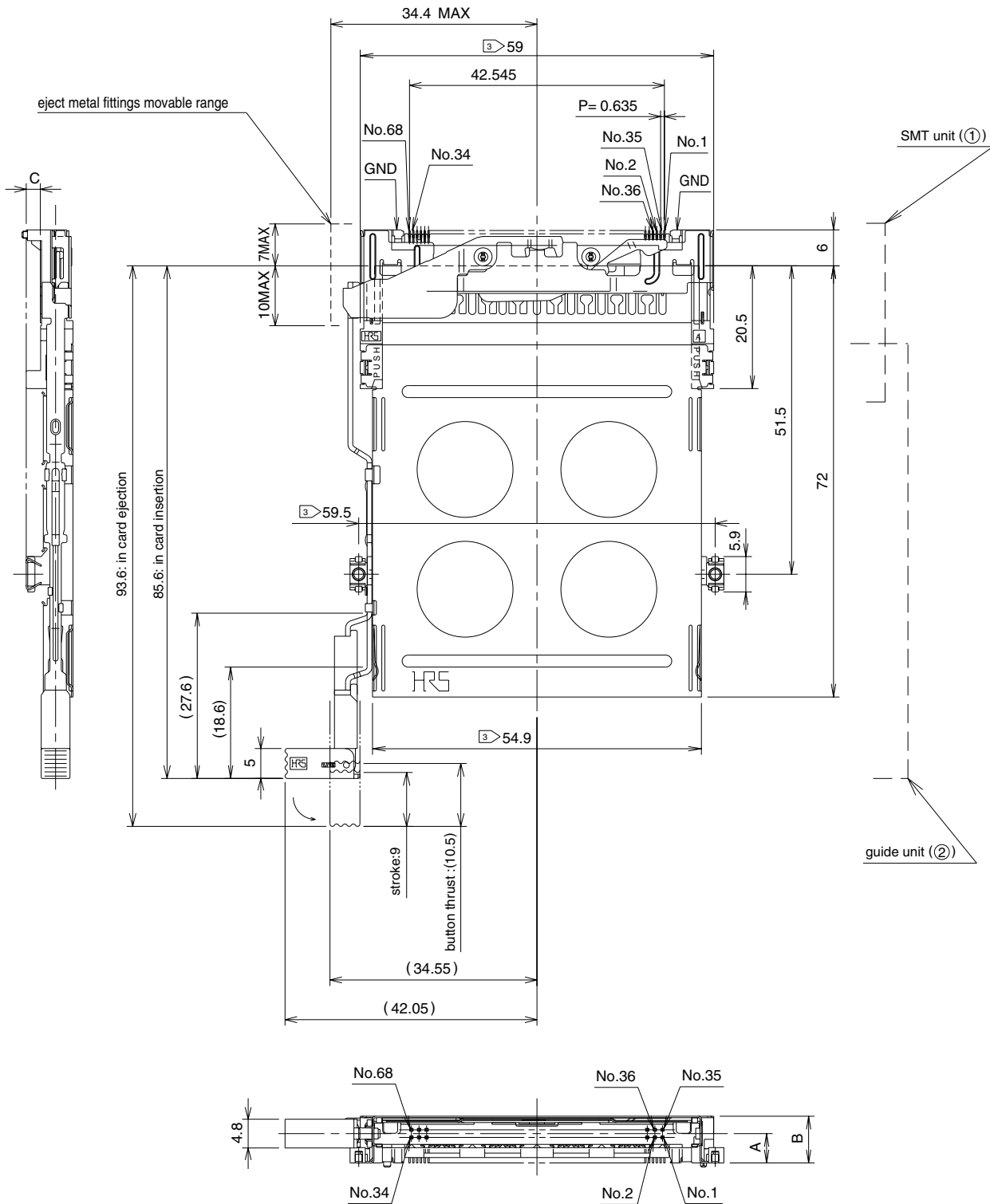

| Standoff type | ①SMT unit | | ②Guide unit | | A (mm) | B (mm) | C (mm) | Weight (g) |
|---------------|-------------------------|------------|-----------------|------------|--------|--------|--------|------------|
| | Part Number | CL No. | Part Number | CL No. | | | | |
| none | IC11S-68PLR-1.27SF-EJL | 640-1004-5 | IC11S-BUR-FEJL | 640-1060-6 | 2.7 | 5.6 | 0.1 | 13.5 |
| 2.2mm | IC11SA-68PLR-1.27SF-EJL | 640-1006-0 | IC11SA-BUR-FEJL | 640-1062-1 | 4.9 | 7.8 | 2.3 | 14 |

Note.1) This figure illustrates grouping of SMT unit(①) and guide unit(②) together.

Note.2) Dimensions for card fitting are in accordance with "PC Card Standard".

Note.3) Indicated dimensions are symmetrical to the center of the card insertion slot.

Reverse

Right POP-UP button type

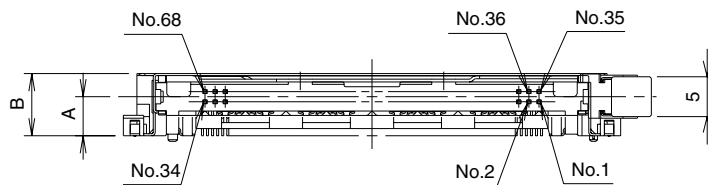
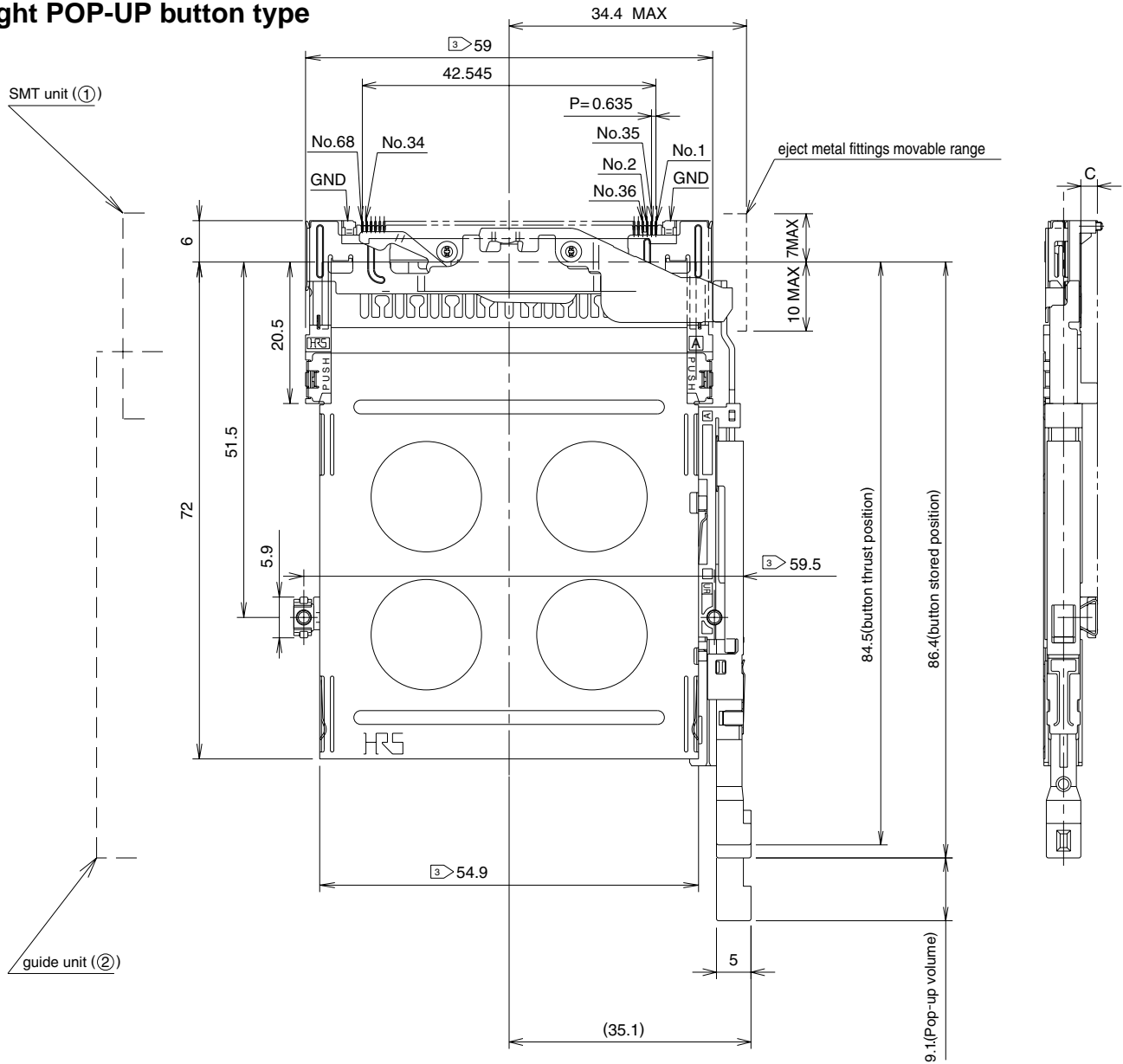

| Standoff type | ①SMT unit | | ②Guide unit | | A (mm) | B (mm) | C (mm) | Weight (g) |
|---------------|-------------------------|------------|-----------------|------------|--------|--------|--------|------------|
| | Part Number | CL No. | Part Number | CL No. | | | | |
| none | IC11S-68PLR-1.27SF-EJR | 640-1003-2 | IC11S-BUR-PEJR | 640-1065-0 | 2.7 | 5.6 | 0.1 | 15.1 |
| 2.2mm | IC11SA-68PLR-1.27SF-EJR | 640-1005-8 | IC11SA-BUR-PEJR | 640-1067-5 | 4.9 | 7.8 | 2.3 | 15.6 |

Note.1) This figure illustrates grouping of SMT unit(①) and guide unit(②) together.

Note.2) Dimensions for card fitting are in accordance with "PC Card Standard".

Note.3) Indicated dimensions are symmetrical to the center of the card insertion slot.

Reverse

Left POP-UP button type

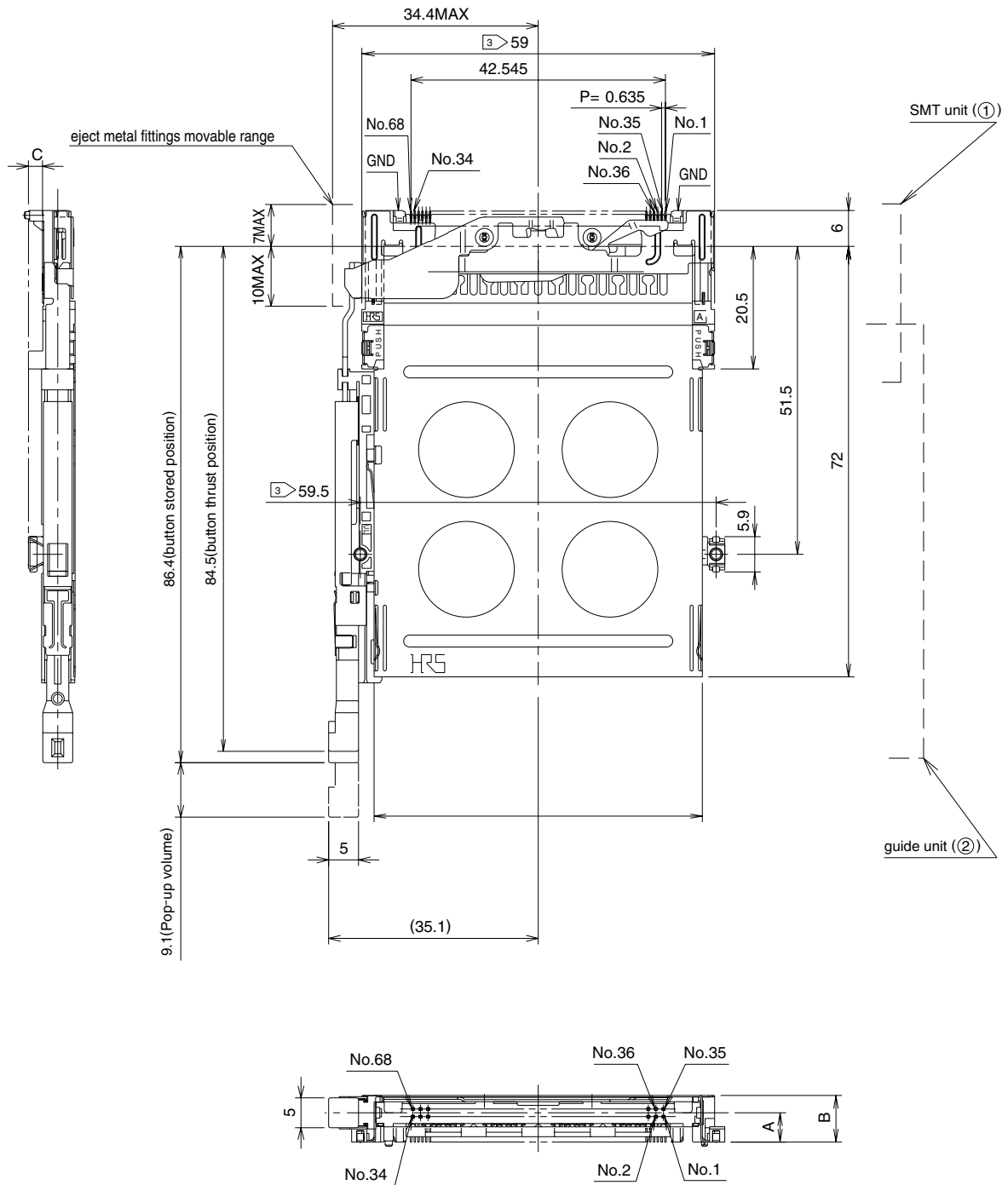

| Standoff type | ①SMT unit | | ②Guide unit | | A (mm) | B (mm) | C (mm) | Weight (g) |
|---------------|-------------------------|------------|-----------------|------------|--------|--------|--------|------------|
| | Part Number | CL No. | Part Number | CL No. | | | | |
| none | IC11S-68PLR-1.27SF-EJL | 640-1004-5 | IC11S-BUR-PEJL | 640-1066-2 | 2.7 | 5.6 | 0.1 | 15.1 |
| 2.2mm | IC11SA-68PLR-1.27SF-EJL | 640-1006-0 | IC11SA-BUR-PEJL | 640-1068-8 | 4.9 | 7.8 | 2.3 | 15.6 |

Note.1) This figure illustrates grouping of SMT unit(①) and guide unit(②) together.

Note.2) Dimensions for card fitting are in accordance with "PC Card Standard".

Note.3) Indicated dimensions are symmetrical to the center of the card insertion slot.

PCB mounting pattern

Standard Type

Without standoff

(right button)

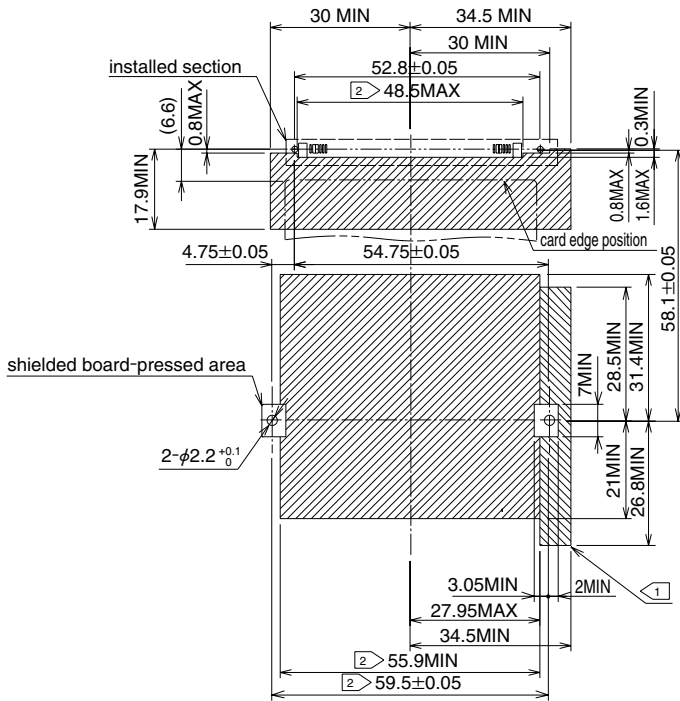

Without standoff

(left button)

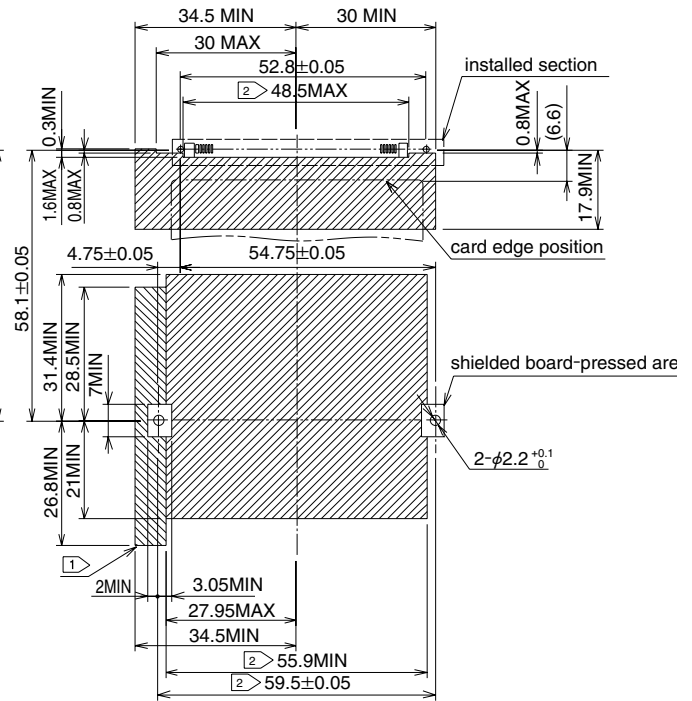

Standoff 2.2mm

(common to both right and left buttons)

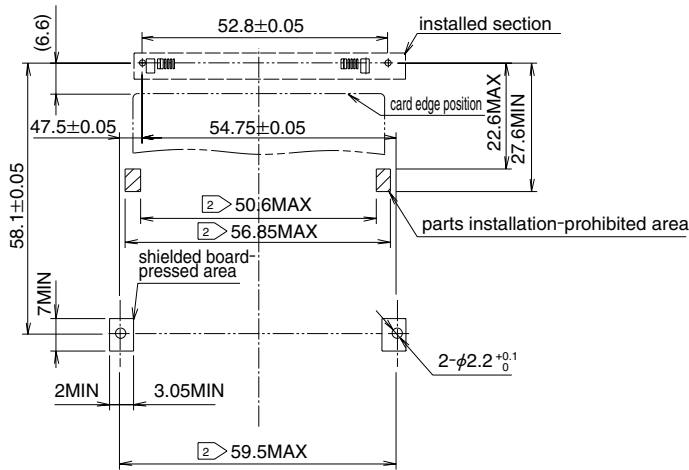

Note.1) area and area show the pattern-inhibited area.

However area will be the pattern-inhibited area only when guide unit is "IC11S-BD-PEJ*".

Note.2) Indicated dimensions are symmetrical to the center of the card insertion slot.

◆PCB mounting pattern (Enlarged)

●Standard type

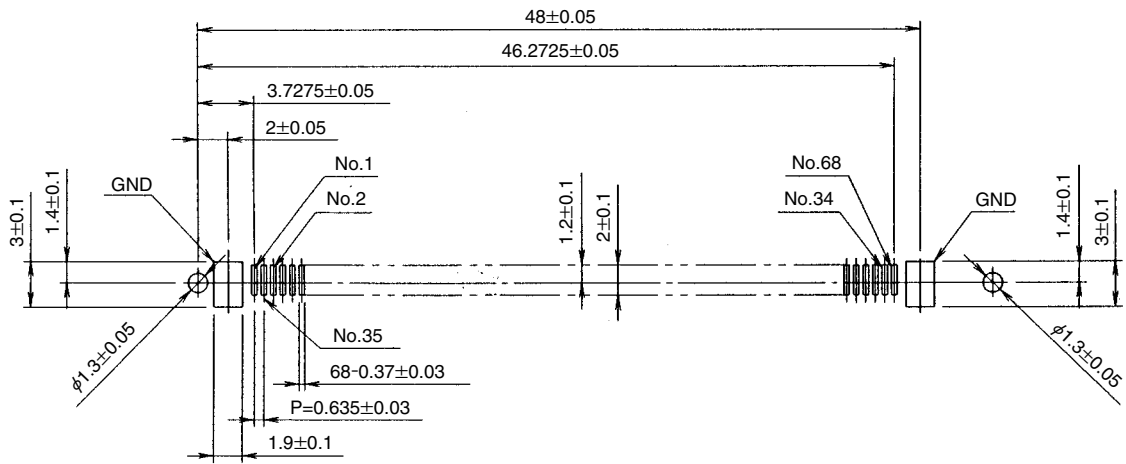

●Reverse Type

●Without standoff

(right button)

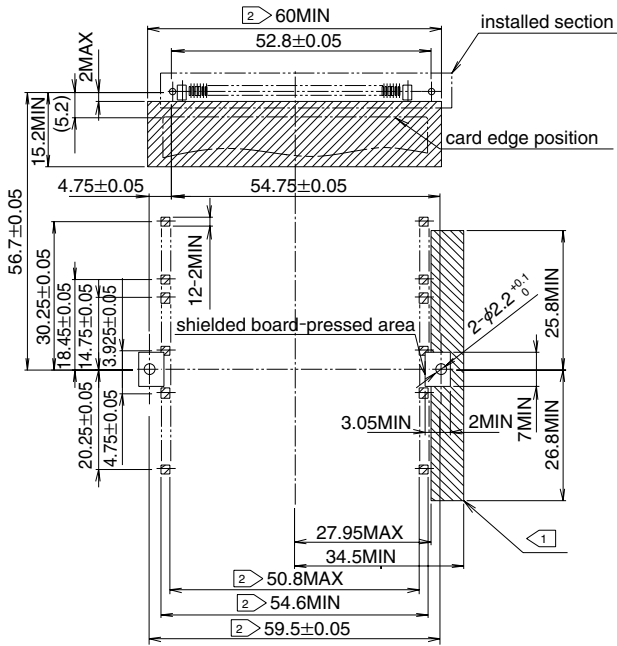

●Without standoff

(left button)

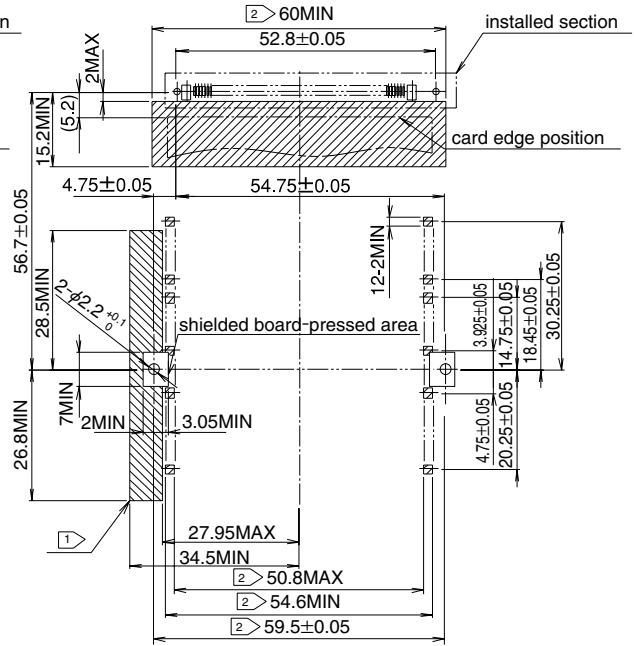

●Standoff 2.2mm

(common to both right and left buttons)

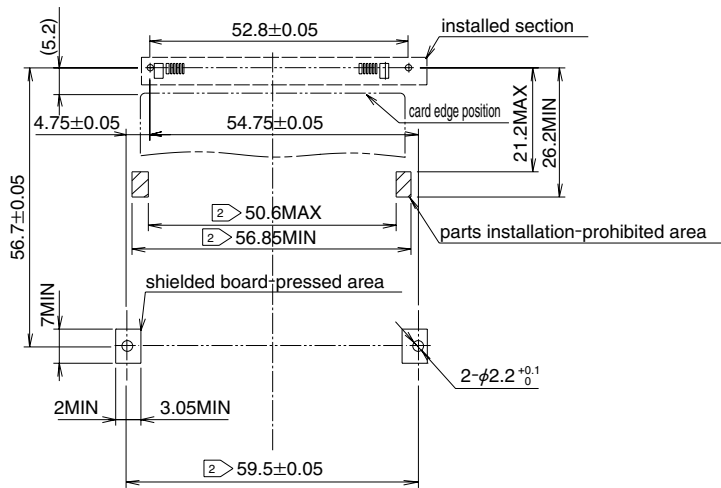

Note.1) area and area show the pattern-inhibited area.

However area will be the pattern-inhibited area only when guide unit is "IC11S-BUR-PEJ".

Note.2) Indicated dimensions are symmetrical to the center of the card insertion slot

■How To Install In Board(Standard Type)

(1)Install SMT unit.

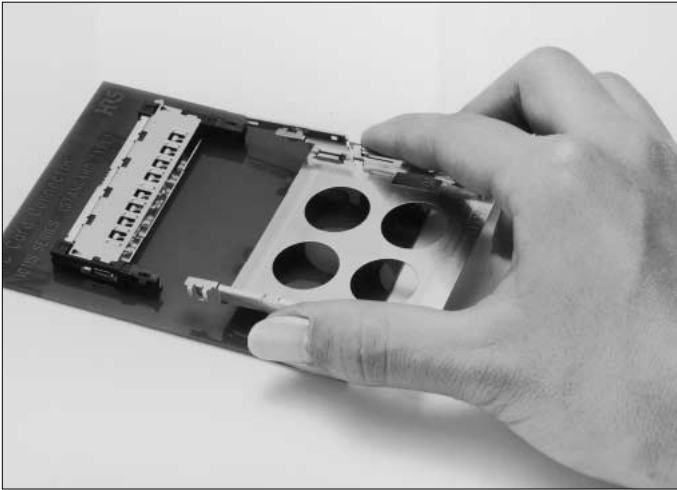

(2)Position the lock section of guide unit into the hole of SMT unit.

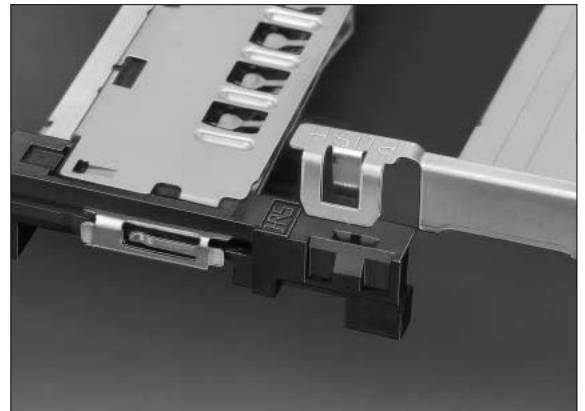
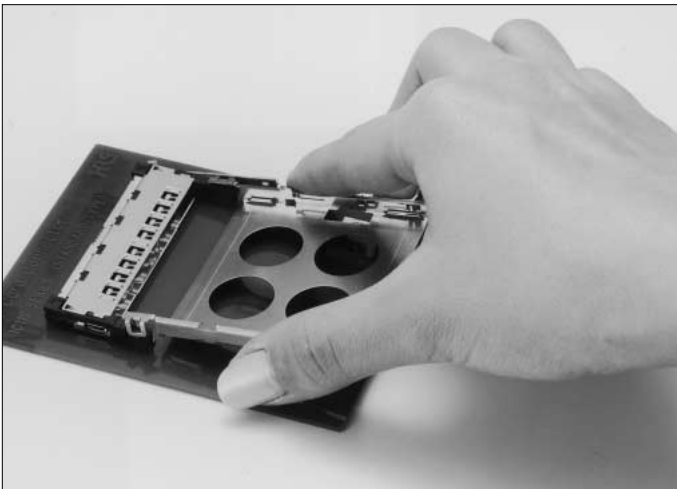

(3)Press the lock top of guide unit to push into SMT unit securely (i.e., until clicked.)

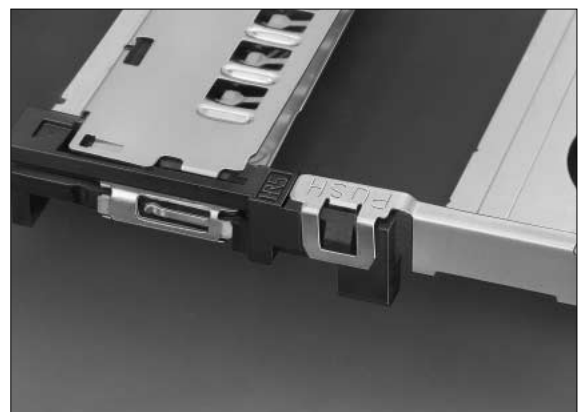

(Note.) Avoid pressing any section other than lock top because it may cause guide plate deformation.

(4)Screw 2 spots to guide unit from the back side of board.

| Screw designation | Pitch | Recommended tightening torque |
|-------------------|-------|-------------------------------|
| M2 | 0.4 | 1.5 to 2.0 (kgf • cm) |

■How To Install In Board(Reverse Type)

(1)Install SMT unit.

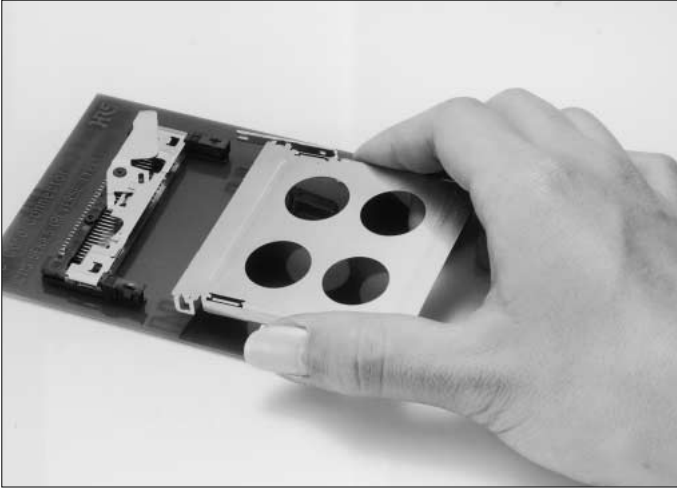

(2)Position the lock section of guide unit into the hole of SMT unit.

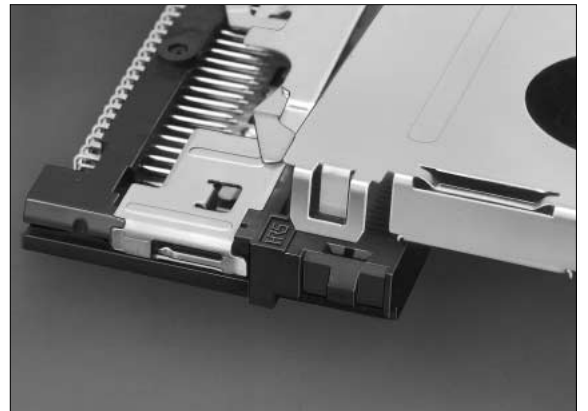

(3)Press the lock top of guide unit to push into SMT unit securely (i.e., until clicked.)

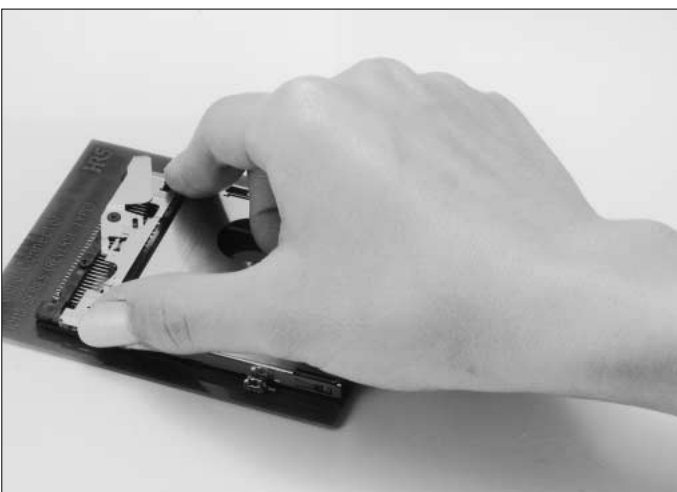

(Note.) Avoid pressing any section other than lock top because it may cause guide plate deformation.

(4)Screw 2 spots to guide unit from the back side of board.

| Screw designation | Pitch | Recommended tightening torque |
|-------------------|-------|-------------------------------|
| M2 | 0.4 | 1.5 to 2.0 (kgf • cm) |

■PreCautions In Installation To Boards

1. After installation of SMT unit to boards, verify that the stroke arm of SMT unit and the push rod of guide unit are located on the positions shown in fig.①.
Also note that guide unit cannot be solder reflowed.

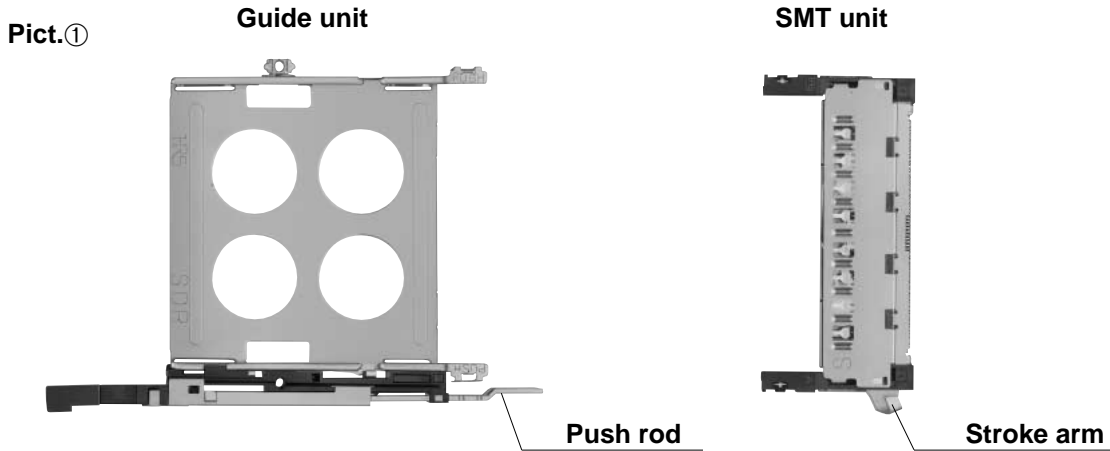

2. Note that the stroke arm of SMT unit and the push rod of guide unit cannot be combined when located in the position as shown in fig.②.

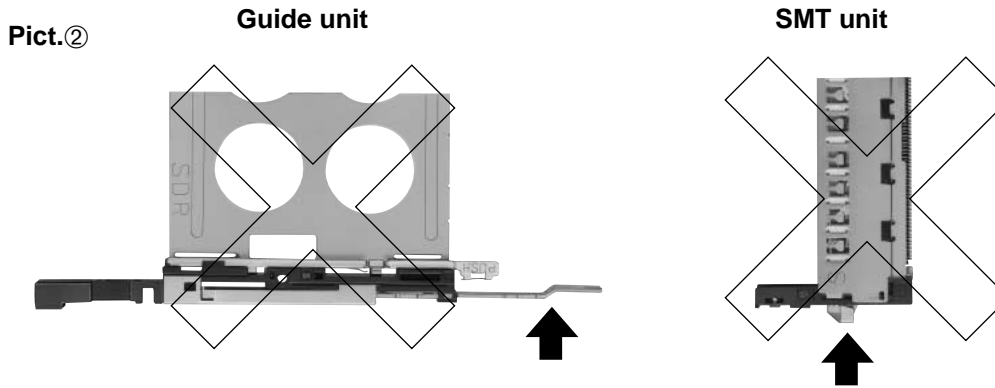

If located in the position shown in fig.② move it to the position shown in fig. ① by fingers.

Guide unit

SMT unit

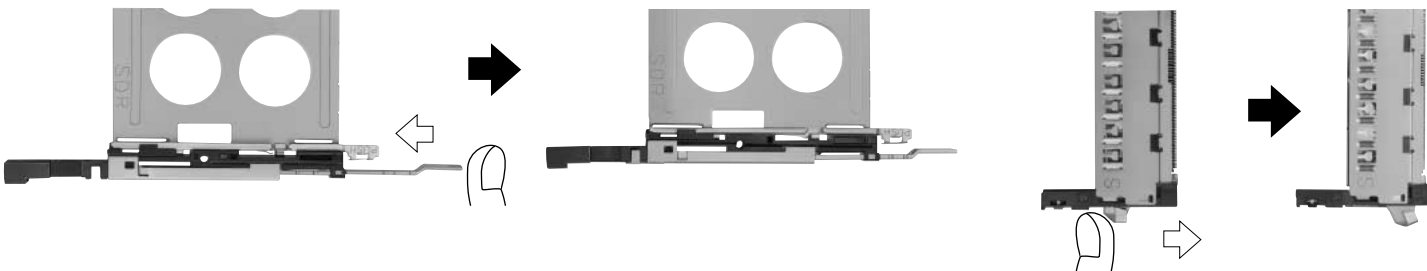

3. After SMT unit and guide unit are combined, state will be found as follows :

●When the push rod was pressed:

●When the push rod was extracted:

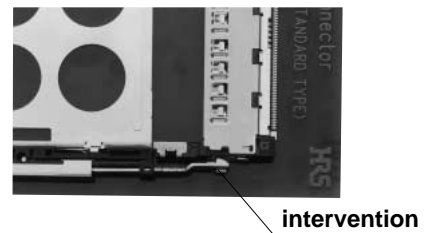
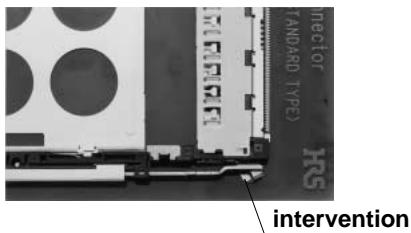

■Pre Caution In Handling

Guide plate is metallic, having some sharp-edged portions. Handle carefully to prevent injury to fingers.

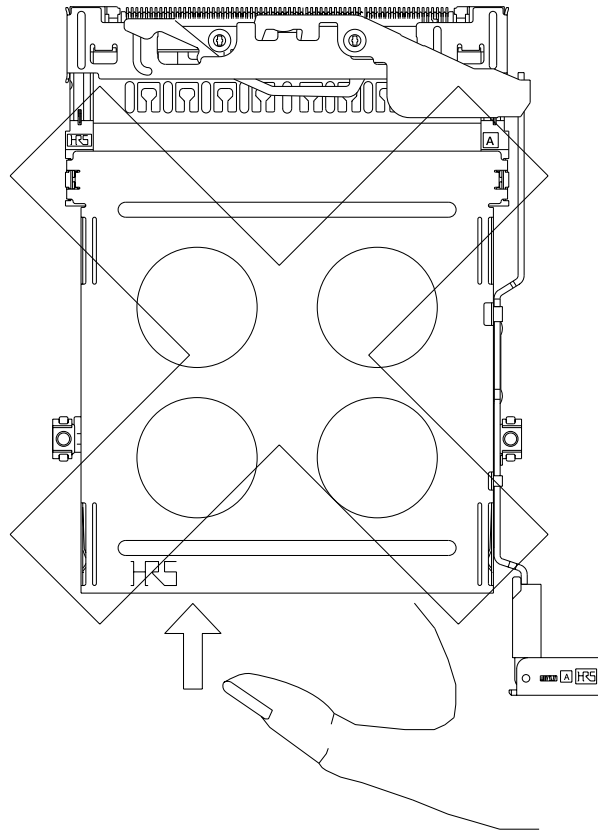

Do not wrench the card up and down severely in the midst of insertion. This may cause damage to the connectors or cards.

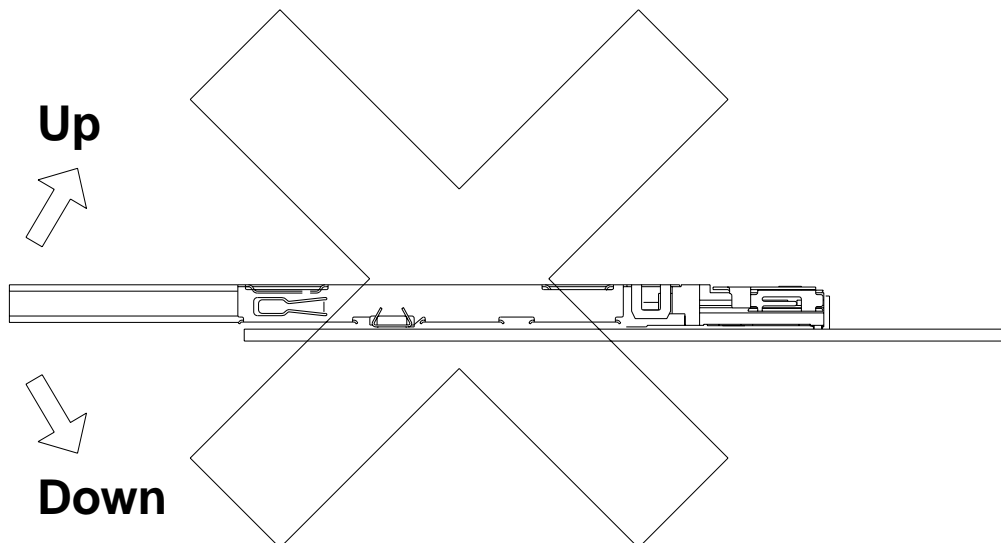

Temperature Profile

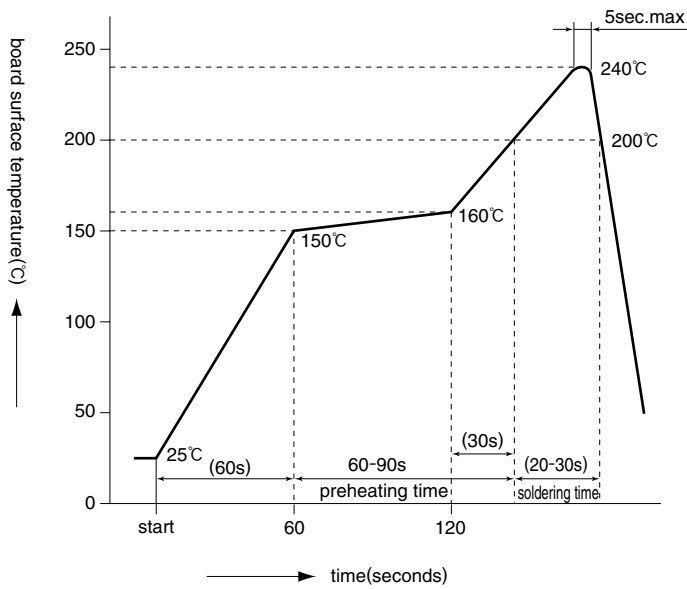

Applicable Conditions

Reflow system : IR reflow

Solder : Paste type 63 Sn/37 Pb
(Flux content 9 wt%)

Test board Glass epoxy 60mm x 60mm x 1.6 mm

Metal mask thickness: 0.15 mm

Recommended temperature profile.

The temperature may be slightly changed according to the solder paste type and amount.

Single Slot SMT Connectors For Card-Bus Based PC Cards

IC11S Series (New POP-UP Button)

PC Card Standard Compliant

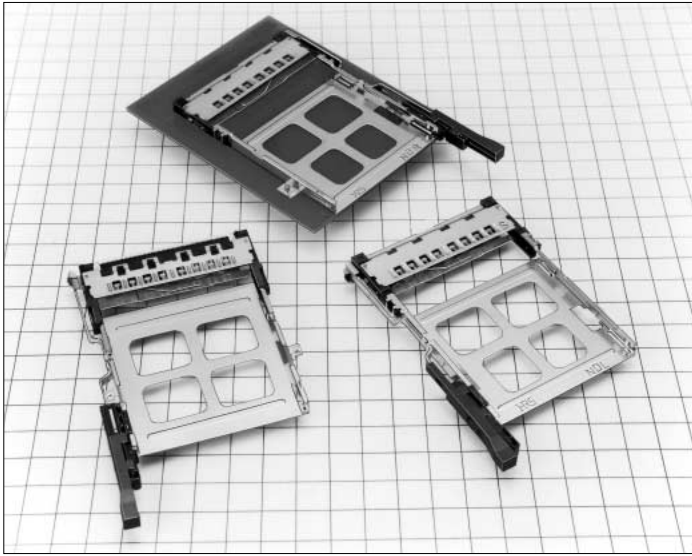

Reduced height : 5.6mm high



■Features

1. PC Card Standard compliant:

- Grounding is required to meet the high speed signal requirements of the PC card standard. Grounding reliability is achieved with a grounding plate and 8 grounding contacts.
- Type I , type II and type III cards are covered.
- Terminals for ground clipping are provided.

2. Reduced pattern-inhibited area

Pattern-inhibited area is reduced, compared to our conventional product.

3. Light-Weight

Approx. 12% of weight reduced.

Compared to conventional type, it only weighs 13.1g for standard type with 0mm standoff.

4. Reduced Height:

Connector height is minimized to 5.6mm, making possible thinner product designs.

5. Eject mechanism with high-level functionality

Hirose Electric's original ejection mechanism provides an higher degree of card ejection over existing products. This improves the operational qualities of card removal. (Patents pending)

6. Wide Variety of Options Available

- Standard type mounts to the top of the PC board and reverse type mounts on the underside of the board
- Three types of eject buttons; rigid, flexible and POP-UP. All types can be installed on the right or left side of the ejector.
- Available with standoff to utilize space under the connector for mounting other parts.

Wide variety of options

(1) Board Mounting

- ① Standard type
- ② Reverse type

(2) Position of eject buttons

- ① Right
- ② Left

(3) Standoffs

- ① 0mm
- ② 2.2mm



Standard type

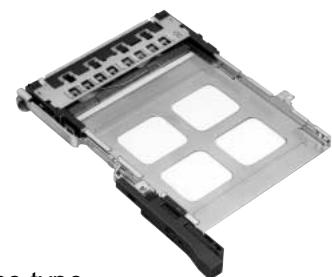

Reverse type

■Product Specifications

| | | | | | | |
|---------|----------------|---------|-----------------------|--|---------------------|------------------------|
| Ratings | Current rating | 0.5A | Operating temperature | -55°C to +85°C(Note.1) | Storage temperature | -40°C to +70°C(Note.2) |
| | Voltage rating | 125V AC | Operating humidity | Relativehumidity 95% or less (With no dew-fall) | Storage humidity | 40% to 70%(Note.2) |

| Item | Specification | Conditions |
|--|---|--|
| 1.Insulation resistance | 1000M ohms min. | 500V DC |
| 2.Withstanding voltage | No flashover or insulation breakdown. | 500V AC |
| 3.Contact resistance | 60m ohms max. (initial value) | 1mA |
| 4.Vibration | No electrical discontinuity of 100ns or more | Frequency: 10 to 2000 Hz, full amplitude of 1.52 mm or acceleration of 147 m/s ² (peak), 4 hours in each of the 3 directions. |
| 5.Humidity (Steady state) | Insulation resistance: 100M ohms min. | 96 hours at temperature of 40°C and humidity of 90% to 95% |
| 6.Temperature cycle | Insulation resistance: 100M ohms min. | (-55°C:30min.→+5°C to 35°C:MAX 5min→+85°C:30min→+5-35°C:MAX 5min.) 5 cycles |
| 7.Durability (Insertion/withdrawal) | Variations from initial contact resistance: 20m ohms max. | 10000 cycles at 400 to 600 cycles per hour |
| 8.Resistance to Soldering heat | No deformation of components affecting performance. | Reflow: At the recommended temperature profile |
| | | Manual soldering: 300°C for 3 seconds |

Note 1: Includes temperature rise caused by current flow.

Note 2: The term "storage" refers to products stored for long period of time prior to mounting and use. Operating Temperature Range and Humidity range covers non- conducting condition of installed connectors in storage, shipment or during transportation.

■Materials

●SMT unit

| Parts | | Material | Finish | Remarks |
|----------------------|------------------------|-----------------|---|---------|
| Insulator | | PPS | Color : Black | UL94V-0 |
| Terminal | Card connected section | Brass | Contact section: gold plating Lead section: solder plating | — |
| | Ground plate | Phosphor bronze | Contact section: gold plating Lead section: solder plating | — |
| Eject metal fittings | | Stainless steel | — | — |

●Guide unit

| Description | | Material | Finish | Remarks |
|--------------|---------------|-----------------|---------------|---------|
| Guide plate | | Stainless steel | — | — |
| Push rod | | Stainless steel | — | — |
| Eject Button | Resin section | PBT | Color : Black | UL94V-0 |
| | Spring | Steel | — | — |
| | Cam | Zinc alloy | — | — |

■ Ordering Information

● SMT Unit

IC11S A - 68 PLR - 1.27SF - EJ R
 ① ② ③ ④ ⑤ ⑥ ⑦

| | |
|--|---|
| ① Series name : IC11S | ⑤ 1.27SF : 1.27mm pitch SMT connector |
| ② Standoff type Blank : none A : 2.2mm | ⑥ With ejector |
| ③ Number of contacts : 68 | |
| ④ Board Mounting Method: PL : standard type PLR : reverse type | ⑦ Eject button positions R : right L : left |

● Guide Unit

IC11S A - BUR - PNEJ R
 ⑧ ⑨ ⑩ ⑪ ⑫

| | |
|---|---|
| ⑧ Series name : IC11S | ⑪ Eject button type PNEJ : POP-UP button |
| ⑨ Standoff type Blank: none A : 2.2mm | |
| ⑩ Board Mounting Method BD : standard type BUR : reverse type | ⑫ Eject button positions R : right L : left |

(Note.) IC11S Series will be used in combination of SMT unit with guide unit. When using, please select the same type for the following items. Note that other combinations cannot be used.

- Series name (① ↔ ⑧)
- Standoff type (② ↔ ⑨)
- Board Mounting Method (④ ↔ ⑩)
- Eject button positions (⑦ ↔ ⑫)

Standard
Right POP-UP button type

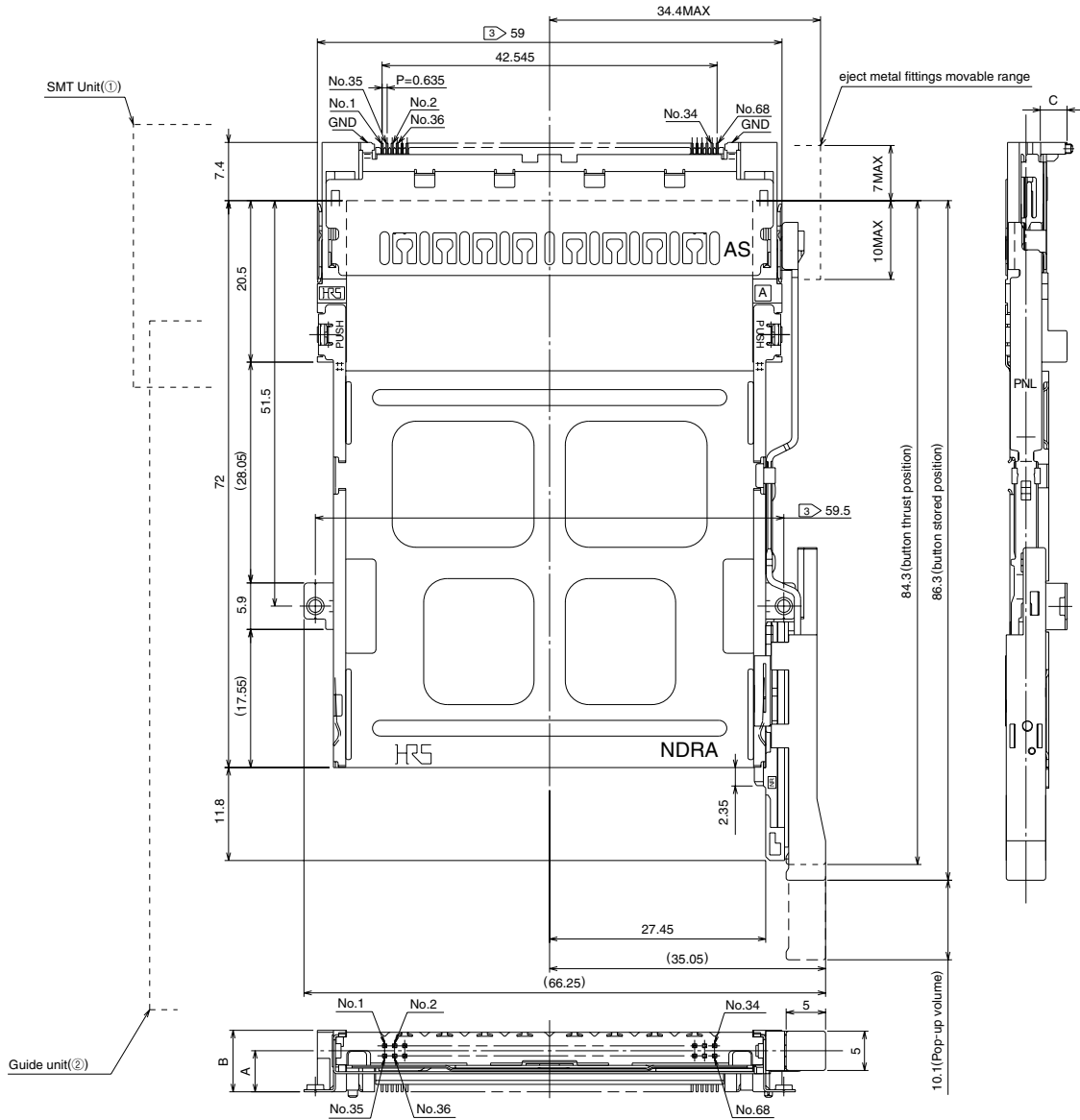

| Standoff type | ①SMT unit | | ②Guide unit | | A (mm) | B (mm) | C (mm) | mass (g) |
|---------------|------------------------|------------|-----------------|------------|--------|--------|--------|----------|
| | Part Number | CL No. | Part Number | CL No. | | | | |
| 0mm | IC11S-68PL-1.27SF-EJR | 640-1007-3 | IC11S-BD-PNEJR | 640-1251-4 | 3 | 5.6 | 0.1 | 13.1 |
| 2.2mm | IC11SA-68PL-1.27SF-EJR | 640-1009-9 | IC11SA-BD-PNEJR | 640-1253-0 | 5.2 | 7.8 | 2.3 | 13.6 |

Note.1) This figure illustrates grouping of SMT unit(1) and guide unit(2) together.
 Note.2) Dimensions for card fitting are in accordance with "PC Card Standard".
 Note.3) Indicated dimensions are symmetrical to the center of the card insertion slot.

Reverse
Right POP-UP button type

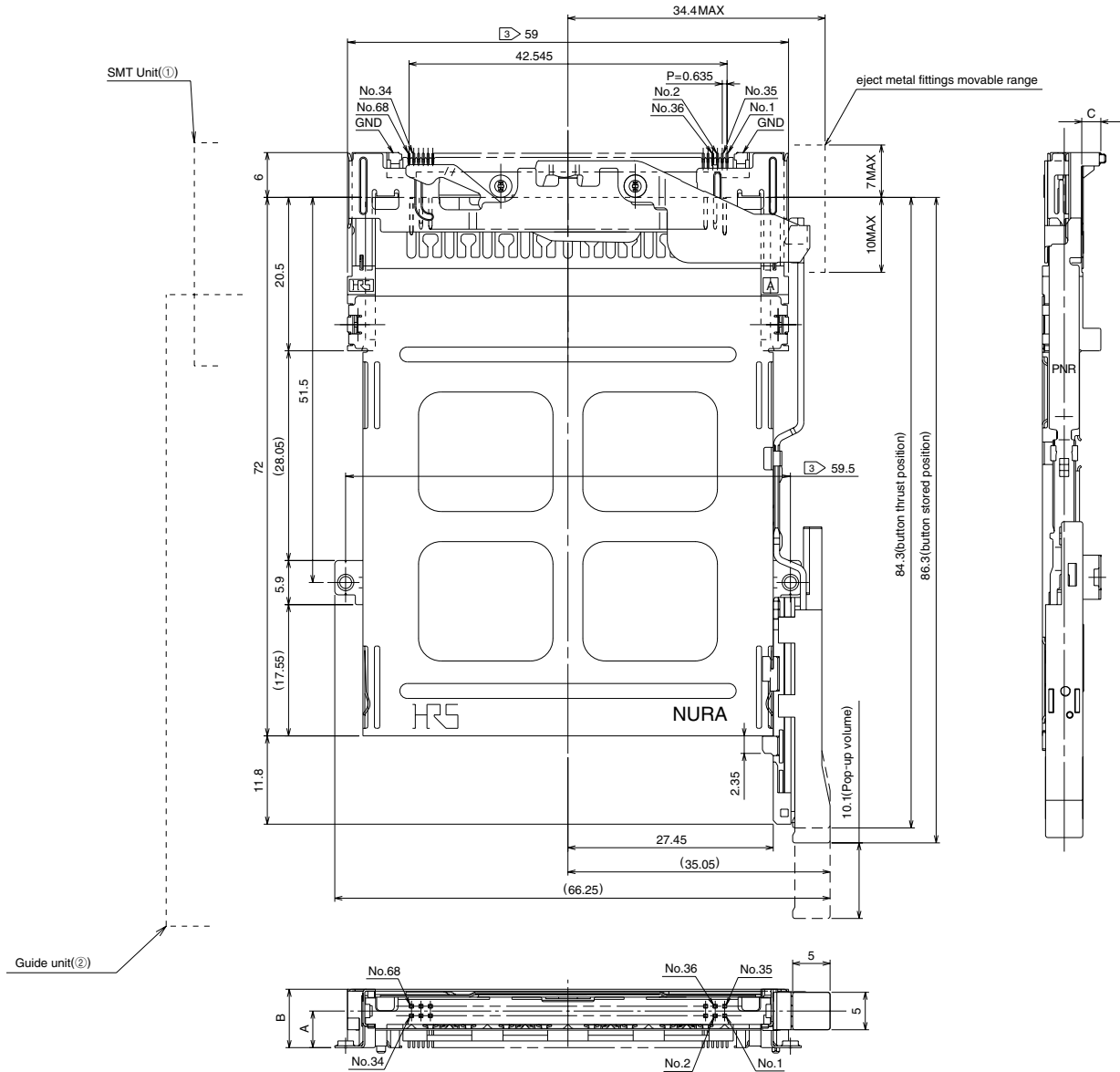

| Standoff type | ①SMT unit | | ②Guide unit | | A (mm) | B (mm) | C (mm) | mass (g) |
|---------------|-------------------------|------------|------------------|------------|--------|--------|--------|----------|
| | Part Number | CL No. | Part Number | CL No. | | | | |
| 0mm | IC11S-68PLR-1.27SF-EJR | 640-1003-2 | IC11S-BUR-PNEJR | 640-1255-5 | 2.7 | 5.6 | 0.1 | 13.3 |
| 2.2mm | IC11SA-68PLR-1.27SF-EJR | 640-1005-8 | IC11SA-BUR-PNEJR | 640-1257-0 | 4.9 | 7.8 | 2.3 | 13.7 |

Note.1) This figure illustrates grouping of SMT unit(①) and guide unit(②) together.
 Note.2) Dimensions for card fitting are in accordance with "PC Card Standard".
 Note.3) Indicated dimensions are symmetrical to the center of the card insertion slot.

Reverse

Left POP-UP button type

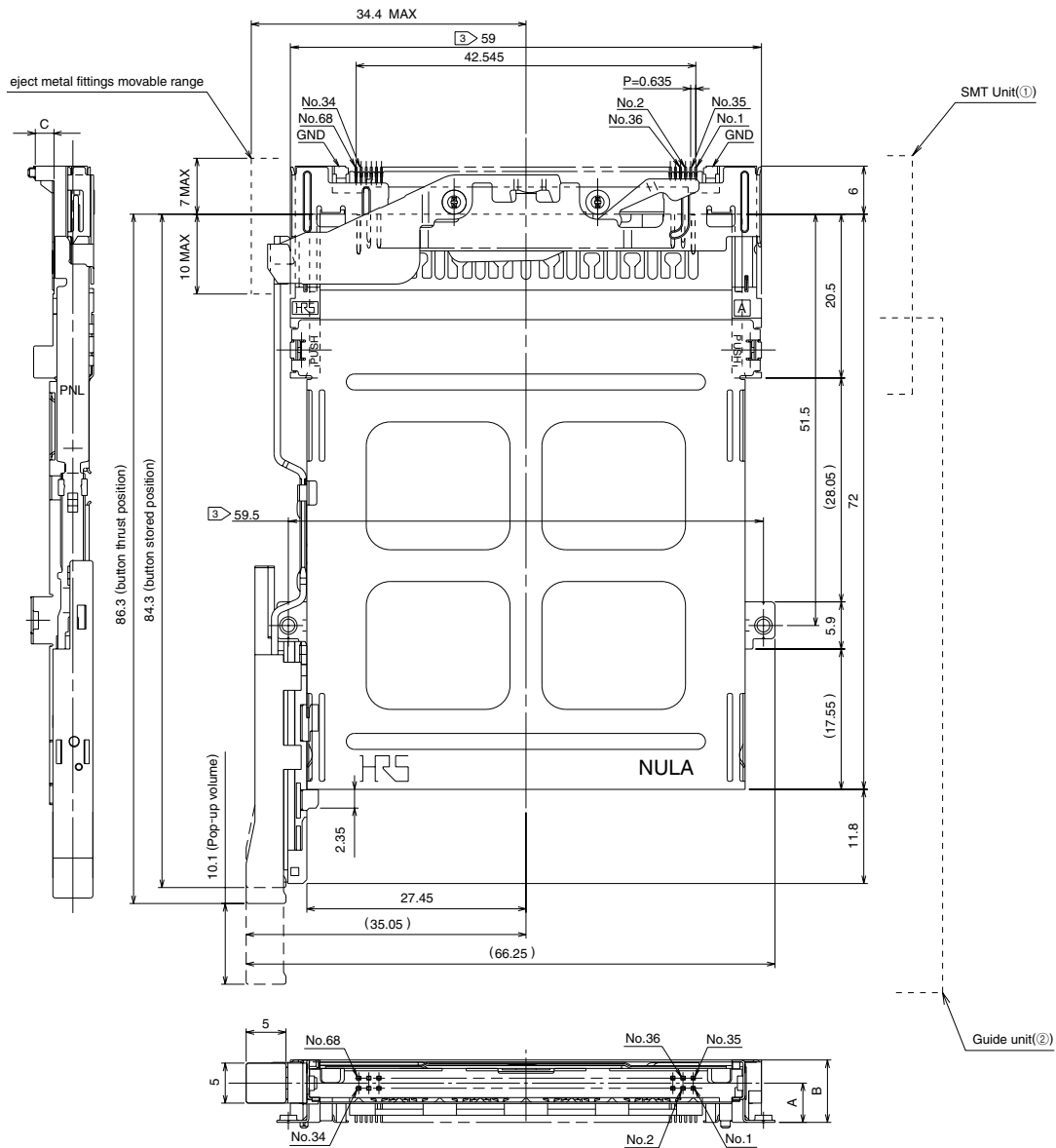

| Standoff type | ①SMT unit | | ②Guide unit | | A (mm) | B (mm) | C (mm) | mass (g) |
|---------------|-------------------------|------------|------------------|------------|--------|--------|--------|----------|
| | Part Number | CL No. | Part Number | CL No. | | | | |
| 0mm | IC11S-68PLR-1.27SF-EJL | 640-1004-5 | IC11S-BUR-PNEJL | 640-1256-8 | 2.7 | 5.6 | 0.1 | 13.3 |
| 2.2mm | IC11SA-68PLR-1.27SF-EJL | 640-1006-0 | IC11SA-BUR-PNEJL | 640-1258-3 | 4.9 | 7.8 | 2.3 | 13.7 |

Note.1) This figure illustrates grouping of SMT unit(1) and guide unit(2) together.

Note.2) Dimensions for card fitting are in accordance with "PC Card Standard".

Note.3) Indicated dimensions are symmetrical to the center of the card insertion slot.

◆PCB mounting pattern

●Standard Type

●Without standoff

(right button)

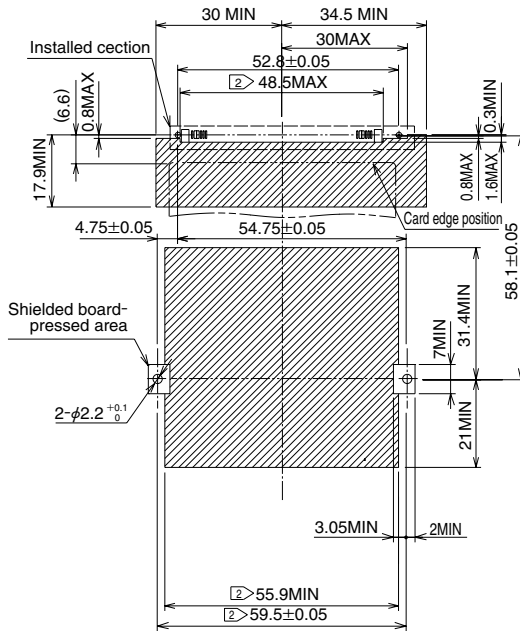

●Without standoff

(left button)

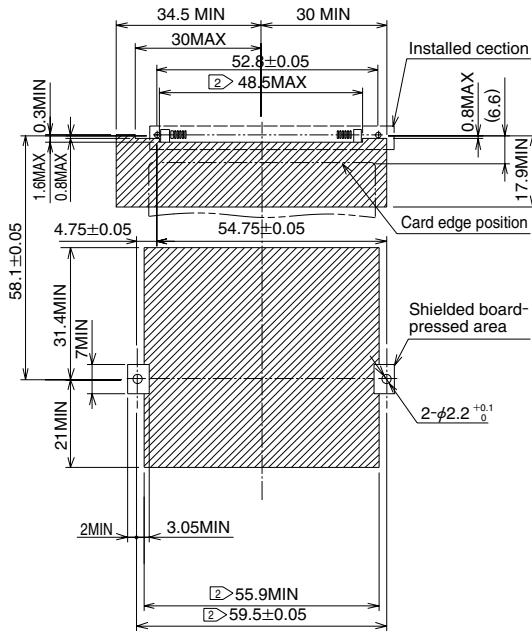

●Standoff 2.2mm

(common to both right and left buttons)

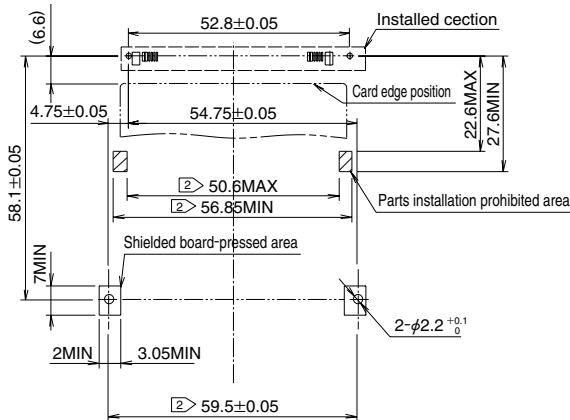

Note.1) area show the pattern-inhibited area.

Note.2) Indicated dimensions are symmetrical to the center of the card insertion slot.

◆PCB mounting pattern (Enlarged)

●Standard type

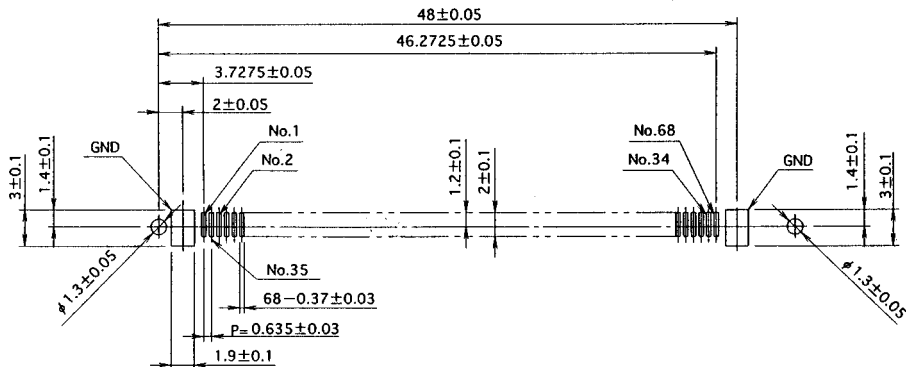

◆PCB mounting pattern

●Reverse Type

●Without standoff

(common to both right and left buttons)

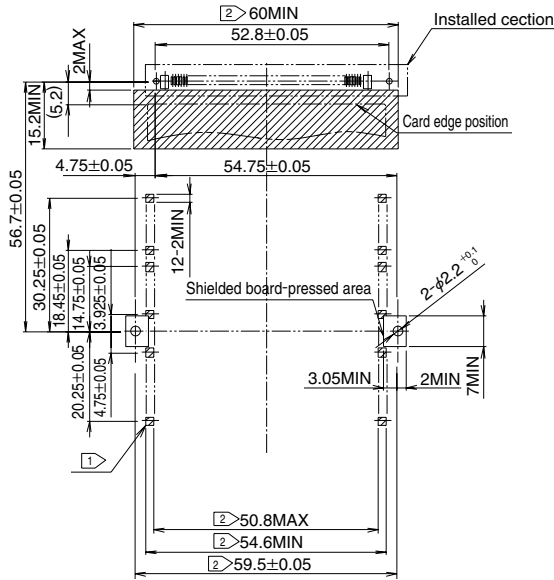

●Standoff 2.2mm

(common to both right and left buttons)

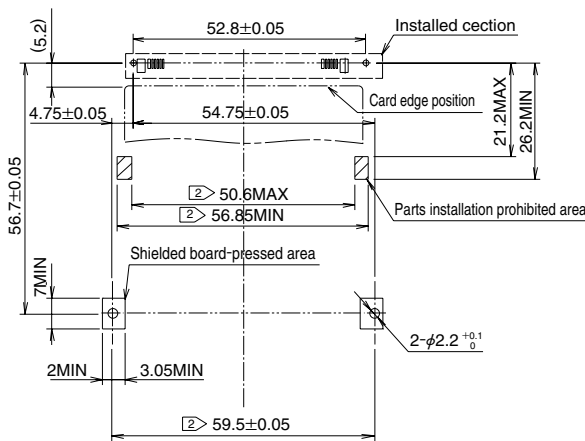

Note.1) area show the pattern-inhibited area.

Note.2) Indicated dimensions are symmetrical to the center of the card insertion slot.

◆PCB mounting pattern (Enlarged)

●Reverse type

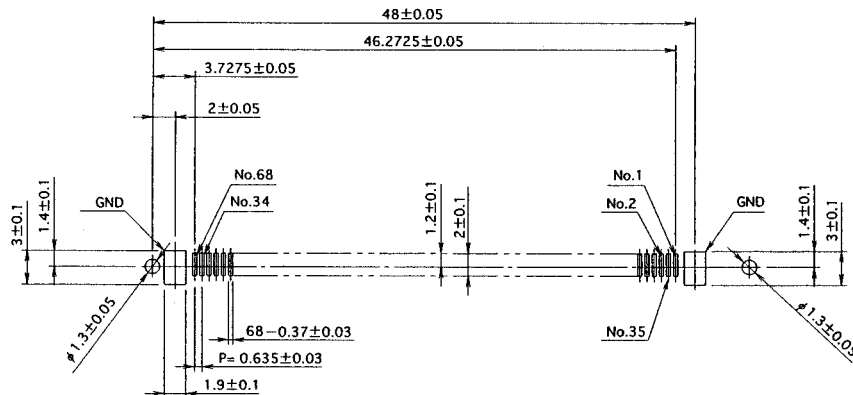

◆How To Install In Board(Standard Type)

(1)Install SMT unit.

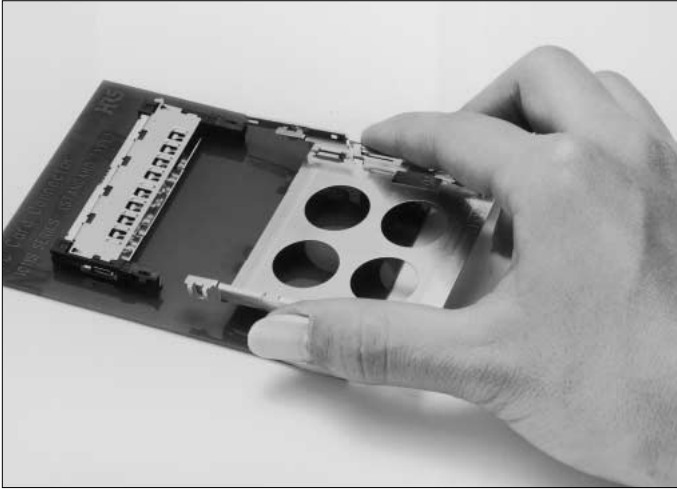

(2)Position the lock section of guide unit into the hole of SMT unit.

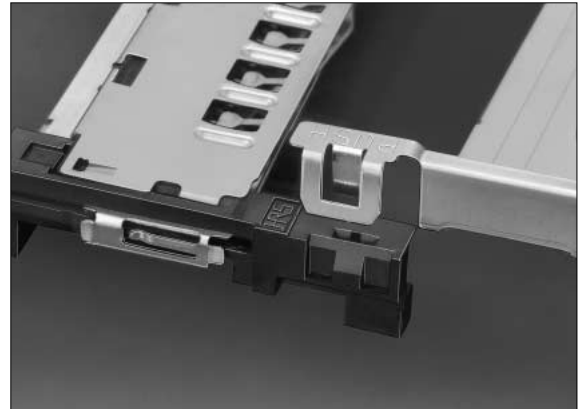
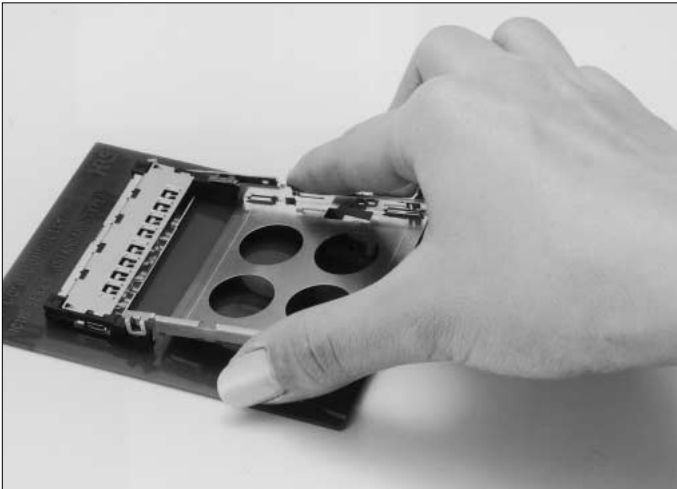

(3)Press the lock top of guide unit to push into SMT unit securely (i.e., until clicked.)

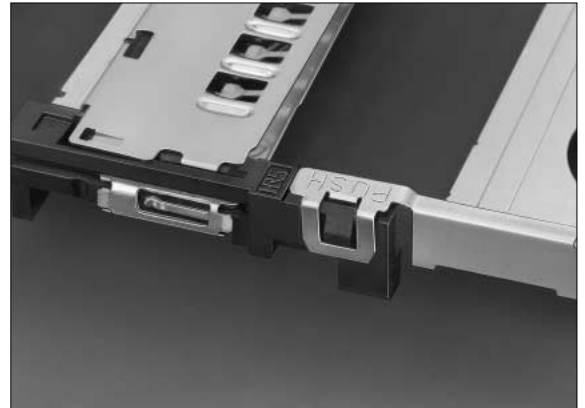

(Note.) Avoid pressing any section other than lock top because it may cause guide plate deformation.

(4)Screw 2 spots to guide unit from the back side of board.

| Screw designation | Pitch | Recommended tightening torque |
|-------------------|-------|-------------------------------|
| M2 | 0.4 | 0.14 to 0.18 (N • m) |

◆How To Install In Board(Reverse Type)

(1)Install SMT unit.

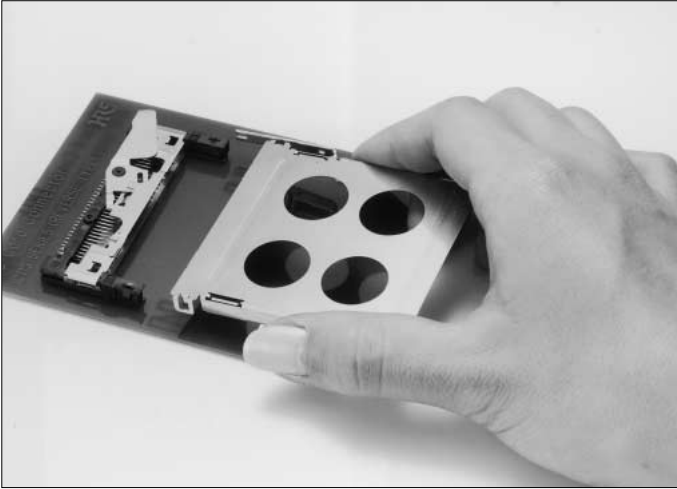

(2)Position the lock section of guide unit into the hole of SMT unit.

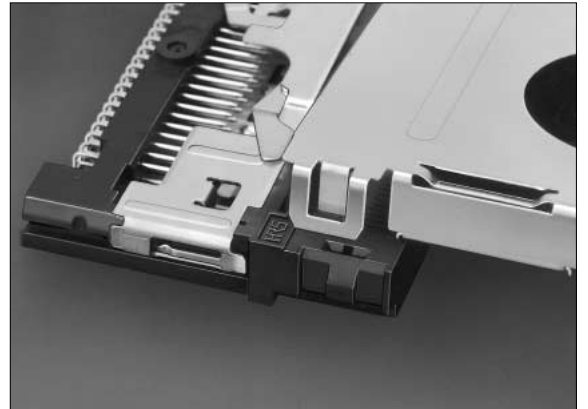

(3)Press the lock top of guide unit to push into SMT unit securely (i.e., until clicked.)



(Note.) Avoid pressing any section other than lock top because it may cause guide plate deformation.

(4)Screw 2 spots to guide unit from the back side of board.

| Screw designation | Pitch | Recommended tightening torque |
|-------------------|-------|-------------------------------|
| M2 | 0.4 | 0.14 to 0.18 (N • m) |

◆ Cautions In Installation To Boards

1. After installation of SMT unit to boards, verify that the stroke arm of SMT unit and the push rod of guide unit are located on the positions shown in fig.①.
Also note that guide unit cannot be solder reflowed.

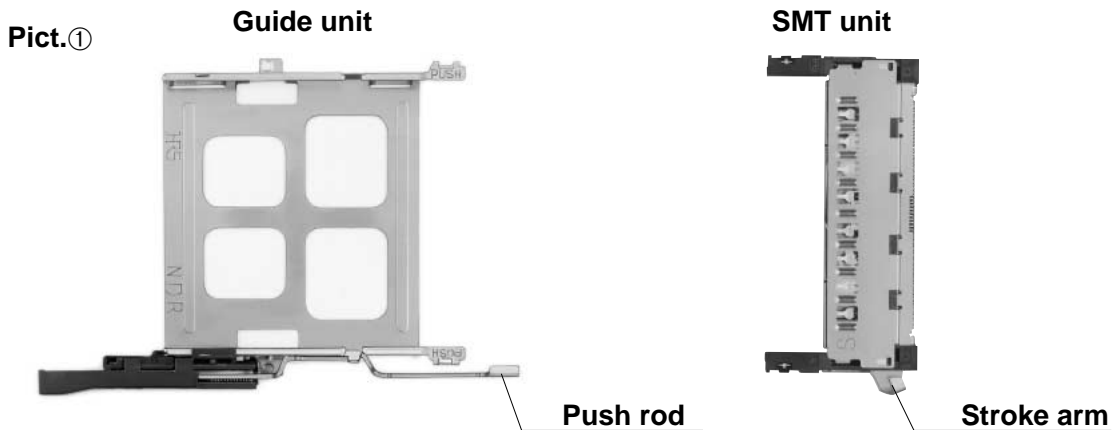

2. Note that the stroke arm of SMT unit and the push rod of guide unit cannot be combined when located in the position as shown in fig.②.

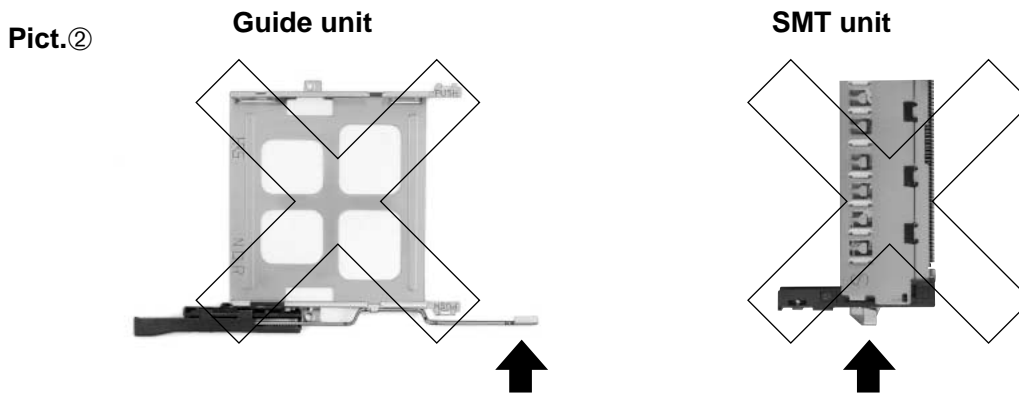

If located in the position shown in fig.② move it to the position shown in fig. ① by fingers.



3. After SMT unit and guide unit are combined, state will be found as follows :

●When the push rod was pressed:

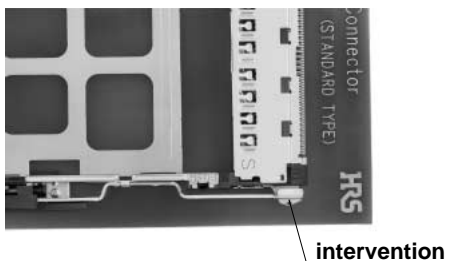

●When the push rod was extracted:

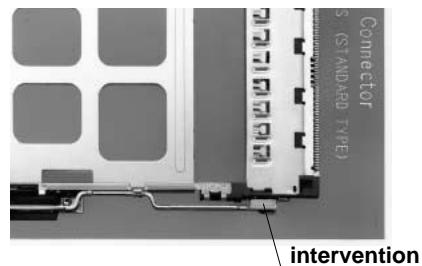

◆ Caution In Handling

Guide plate is metallic, having some sharp-edged portions. Handle carefully to prevent injury to fingers.

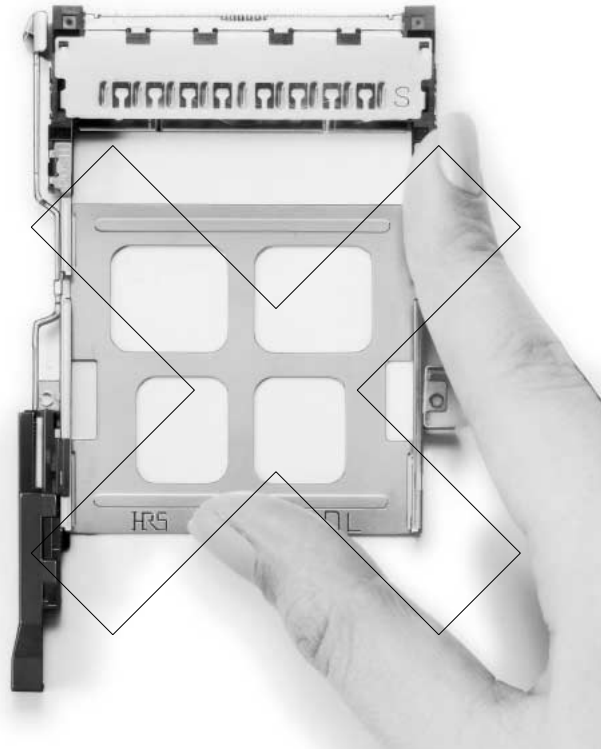

Do not wrench the card up and down severely in the midst of insertion. This may cause damage to the connectors or cards.

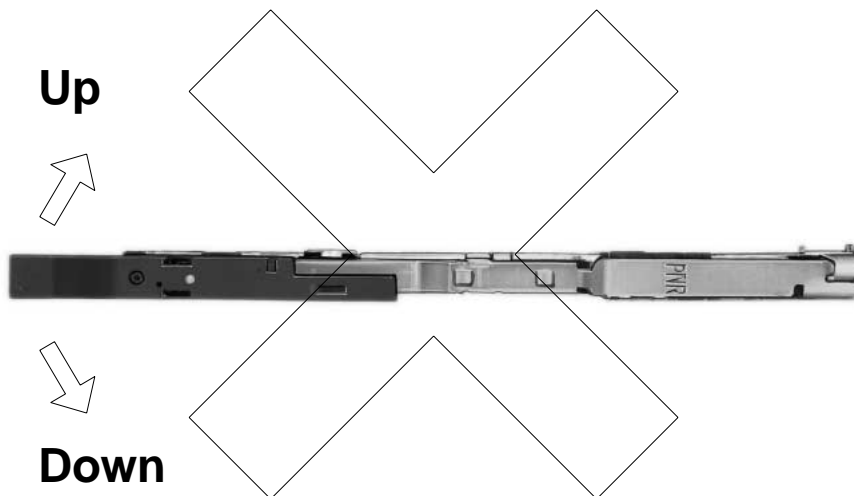

◆ Installation Temperature Profile

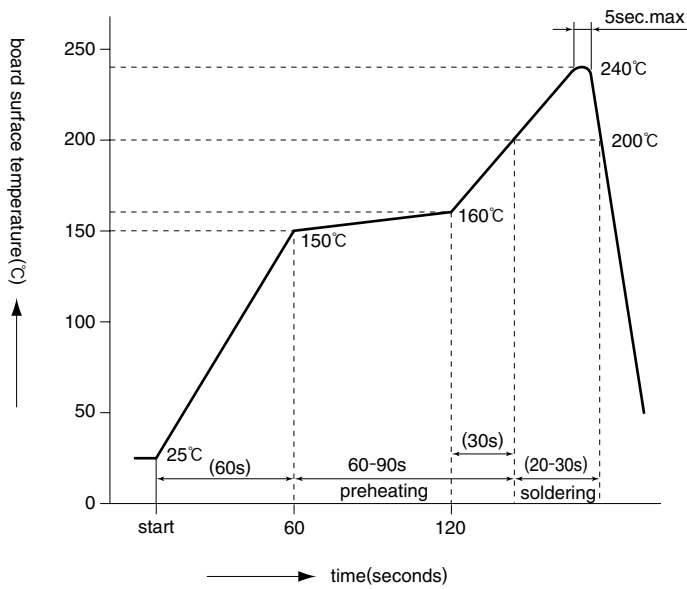

Applicable Conditions

Reflow system : IR reflow

Solder : Paste type 63 Sn/37 Pb
(Flux content 9 wt%)

Test board Glass epoxy 60mm x 60mm x 1.6 mm

Metal mask thickness: 0.15 mm

Recommended temperature profile.

The temperature may be slightly changed according to the solder paste type and amount.