

阅读申明

- 1.本站收集的数据手册和产品资料都来自互联网，版权归原作者所有。如读者和版权方有任何异议请及时告之，我们将妥善解决。
- 2.本站提供的中文数据手册是英文数据手册的中文翻译，其目的是协助用户阅读，该译文无法自动跟随原稿更新，同时也可能存在翻译上的不当。建议读者以英文原稿为参考以便获得更精准的信息。
- 3.本站提供的产品资料，来自厂商的技术支持或者使用者的心得体会等，其内容可能存在描述上的差异，建议读者做出适当判断。
- 4.如需与我们联系，请发邮件到marketing@iczoom.com，主题请标有“数据手册”字样。

Read Statement

1. The datasheets and other product information on the site are all from network reference or other public materials, and the copyright belongs to the original author and original published source. If readers and copyright owners have any objections, please contact us and we will deal with it in a timely manner.
2. The Chinese datasheets provided on the website is a Chinese translation of the English datasheets. Its purpose is for reader's learning exchange only and do not involve commercial purposes. The translation cannot be automatically updated with the original manuscript, and there may also be improper translations. Readers are advised to use the English manuscript as a reference for more accurate information.
3. All product information provided on the website refer to solutions from manufacturers' technical support or users the contents may have differences in description, and readers are advised to take the original article as the standard.
4. If you have any questions, please contact us at marketing@iczoom.com and mark the subject with "Datasheets" .

UltraPort QSFP 1xN cages

Product Specification S6083C Rev 1.0

Amphenol

Now you're connected!

About Amphenol Commercial Products

Amphenol's commercial connector products are used in a variety of end user applications including networking, telecom, server & computer, storage & HDD, consumer electronics and entertainment, professional audio & Industrial & Military/Aerospace.

Related Products

QSFP+



QSFP+ 38 POSITION CONNECTOR

PCI Express

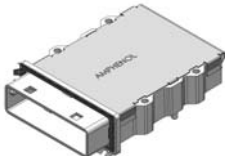

SINGLE 1° CAGE

MiniSAS



26 POSITION CONNECTOR WITH HOLD DOWN TABS



FS1 SINGLE PORT CAGE WITH METAL GASKET

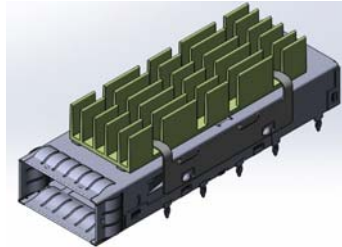

1x1 Cage with Fin heat sink

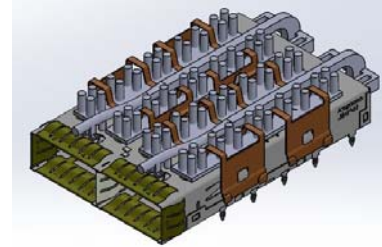

1x2 Cage with round pin heat sinks and single barrel light pipes

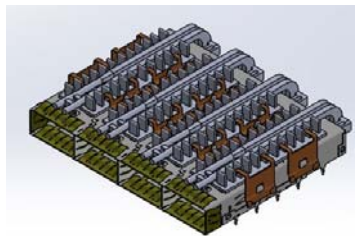

1x4 Cage with pin fin heat sinks and single barrel light pipes

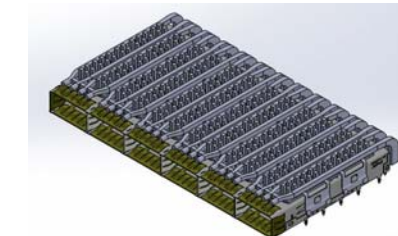

1x6 Cage with square pin heat sinks and quad barrel light pipes

Overview

This short form Product Specification defines the general use and performance parameters for Amphenol's UltraPort QSFP 1xN cage series. It is designed to comply with the Quad Small Form-factor Pluggable (QSFP) SFF-8663 QSFP+ 28Gbps cage specification.

Availability: 1x1, 1x2, 1x3, 1x4 and 1x6 versions are available in thru the bezel configurations. 1x1 One degree cage also available in thru the bezel configuration. Behind bezel and Hybrid versions shall become available soon.

Usage

The UltraPort QSFP single row cages are intended to be used with UltraPort QSFP SMT connector . (Refer to Product spec. S6082C)

Applications

Intended for use in high speed serial interconnect applications such as:

- Cellular hubs
- Switches
- Servers
- Storage devices

Now you're connected!

About Amphenol Commercial Products

Amphenol's commercial connector products are used in a variety of end user applications including networking, telecom, server & computer, storage & HDD, consumer electronics and entertainment, professional audio & Industrial & Military/Aerospace.

Related Products

QSFP+



QSFP+ 38 POSITION CONNECTOR

PCI Express



SINGLE 1° CAGE

MiniSAS



26 POSITION CONNECTOR WITH HOLD DOWN TABS

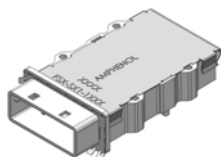

FS1 SINGLE PORT CAGE WITH METAL GASKET

General Requirements

Cages are packaged in trays.

Heat sinks/clips and light pipes are assembled to the cage and placed in the tray if available.

Heat sinks and heat sink clips may be packaged separately for 1x1 options only.

Dust covers are packaged separately if ordered.

"Belly-to-belly" version allows two cages to mount on opposite sides of the PCB.

Cage Mechanical Characteristics

Cages are available with and without Heat Sinks

Cages are available with and without Light Pipes

Cages are press-fit into PCBs

Cages have error proof features according to QSFP MSA

Material Requirements

Unless otherwise specified, the materials for each component shall be:

Cage

- Base material – Phosphor Bronze
- 100 μ " (2.54 μ m) Minimum Nickel plated

Heat Sink

- Base material – Aluminum alloy with Nickel plating

Heat Sink Clip

- Base material – Stainless Steel

Light Pipe

- Base material – Clear Polycarbonate, optical grade

Dust Cover

- Base material – Conductive Rubber

EMI gasket

- Base material – Conductive elastomer

EMI flange

- Base material – Dia cast zinc alloy with Nickel plating

Operating temperature: -40° to +85° C

Storage temperature: -40° to +85° C

Now you're connected!

About Amphenol Commercial Products

Amphenol's commercial connector products are used in a variety of end user applications including networking, telecom, server & computer, storage & HDD, consumer electronics and entertainment, professional audio & Industrial & Military/Aerospace.

Related Products

QSFP+



QSFP+ 38 POSITION CONNECTOR

PCI Express

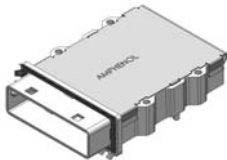

SINGLE 1" CAGE

MiniSAS



26 POSITION CONNECTOR WITH HOLD DOWN TABS

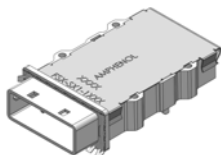

FS1 SINGLE PORT CAGE WITH METAL GASKET

Assembly Instructions

Compliant Pin Holes must be drilled and plated through to specific dimensions to prevent damage during placement of cage assembly on the PCB. See table below.

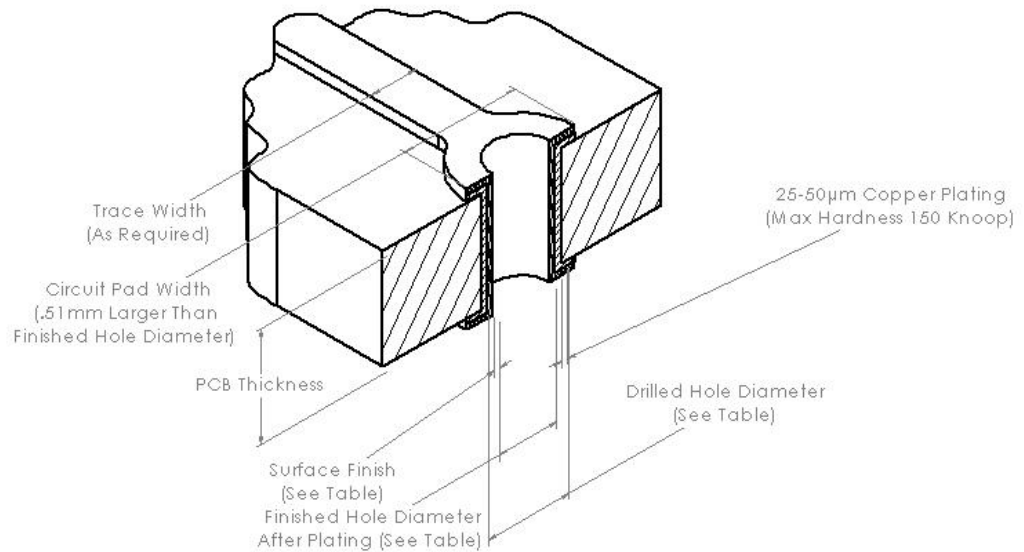

Drawing Not to Scale

Surface Finish	Drilled Hole Diameter	Finished Hole Diameter	Surface Finish Thickness
HASL SnPb	1.15±0.02	1.05 Ref	0.004-0.010
Immersion Sn	1.15±0.02	1.05 Ref	0.0005 Min.
OSP	1.15±0.02	1.05 Ref	0.0002-0.0005
Immersion Au/Ni	1.15±0.02	1.05 Ref	0.004-0.0076 (Ni) 0.0001-0.0005 (Au)

Now you're connected!

About Amphenol Commercial Products

Amphenol's commercial connector products are used in a variety of end user applications including networking, telecom, server & computer, storage & HDD, consumer electronics and entertainment, professional audio & Industrial & Military/Aerospace.

Related Products

QSFP+



QSFP+ 38 POSITION CONNECTOR

PCI Express

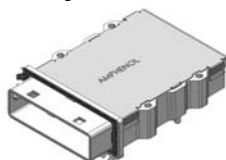

SINGLE 1° CAGE

MiniSAS



26 POSITION CONNECTOR WITH HOLD DOWN TABS



FS1 SINGLE PORT CAGE WITH METAL GASKET

Available Documents

Drawing Numbers:

P-FS1-Z38-X0Z6-10

UltraPort QSFP SMT connector, with resonance dampening feature

P-U95-T(A,L)1X1-1XXX

UltraPort QSFP 1x1 thru the bezel cage, 0 deg. with heat sink and light pipe options

P-U95-T(L)2X1-1XXX

UltraPort QSFP 1x2 thru the bezel cage, 0 deg. with heat sink and light pipe options

P-U95-T(L)3X1-1XXX

UltraPort QSFP 1x3 thru the bezel cage, 0 deg. with heat sink and light pipe options

P-U95-T(L)4X1-1XXX

UltraPort QSFP 1x4 thru the bezel cage, 0 deg. with heat sink and light pipe options

P-U95-T(L)6X1-1XXX

UltraPort QSFP 1x6 thru the bezel cage, 0 deg. with heat sink and light pipe options

P-U95-W1X1-1XXX

UltraPort QSFP 1x1 thru the bezel cage, 1 deg. with heat sink options

P-U95-G(P)1X1-1XXX

UltraPort QSFP 1x1 behind bezel, 0 deg., heat sink and light pipe options-Preliminary

P-U95-G(P)2X1-1XXX

UltraPort QSFP 1x2 behind bezel, 0 deg., heat sink and light pipe options-Preliminary

P-U95-G(P)3X1-1XXX

UltraPort QSFP 1x3 behind bezel, 0 deg., heat sink and light pipe options-Preliminary

P-U95-D(V)1X1-1XXX

UltraPort QSFP 1x1 hybrid cage, 0 deg., heat sink and light pipe options-Preliminary

P-U95-D(V)2X1-1XXX

UltraPort QSFP 1x2 hybrid cage, 0 deg., heat sink and light pipe options-Preliminary

P-U95-D(V)3X1-1XXX

UltraPort QSFP 1x3 hybrid cage, 0 deg., heat sink and light pipe options-Preliminary

P-U95-D(V)4X1-1XXX

UltraPort QSFP 1x4 hybrid cage, 0 deg., heat sink and light pipe options-Preliminary

Contact factory or Authorized Amphenol representative for alternate configurations