

阅读申明

- 1.本站收集的数据手册和产品资料都来自互联网，版权归原作者所有。如读者和版权方有任何异议请及时告之，我们将妥善解决。
- 2.本站提供的中文数据手册是英文数据手册的中文翻译，其目的是协助用户阅读，该译文无法自动跟随原稿更新，同时也可能存在翻译上的不当。建议读者以英文原稿为参考以便获得更精准的信息。
- 3.本站提供的产品资料，来自厂商的技术支持或者使用者的心得体会等，其内容可能存在描述上的差异，建议读者做出适当判断。
- 4.如需与我们联系，请发邮件到marketing@iczoom.com，主题请标有“数据手册”字样。

Read Statement

1. The datasheets and other product information on the site are all from network reference or other public materials, and the copyright belongs to the original author and original published source. If readers and copyright owners have any objections, please contact us and we will deal with it in a timely manner.
2. The Chinese datasheets provided on the website is a Chinese translation of the English datasheets. Its purpose is for reader's learning exchange only and do not involve commercial purposes. The translation cannot be automatically updated with the original manuscript, and there may also be improper translations. Readers are advised to use the English manuscript as a reference for more accurate information.
3. All product information provided on the website refer to solutions from manufacturers' technical support or users the contents may have differences in description, and readers are advised to take the original article as the standard.
4. If you have any questions, please contact us at marketing@iczoom.com and mark the subject with "Datasheets" .

Panasonic
ideas for life

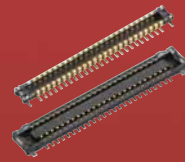

For board-to-FPC
Narrow pitch connectors
ADVANCED Series
0.4mm pitch
A4US



2.2 mm Ultra-slim body with the inherited high reliability

A4US



New

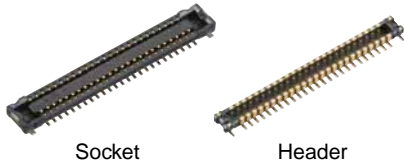

Compliance with RoHS Directive

For board-to-FPC

Narrow pitch connectors (0.4mm pitch)

A4US Series

FEATURES

1. Ultra-slim (Mated width: 2.2 mm and Mated height: 0.8 mm, 1.0 mm and 1.5 mm)

The footprint when mated is down approx. 12% from our existing A4S model (50 contacts), contributing to the functionality enhancement and size reduction of target equipment.

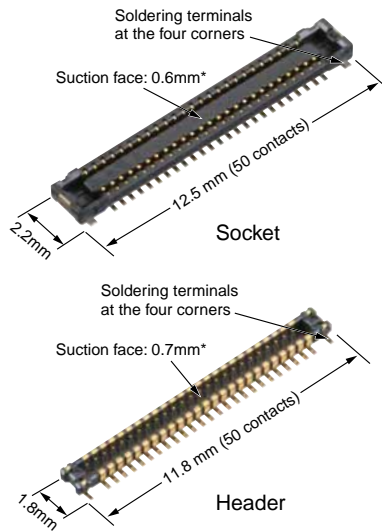

* Suction face size for the 1.0 mm/1.5 mm mated height type: Socket — 0.64 mm, Header — 0.76 mm

2. Improving the degree of design freedom (Mated height of 0.8 mm, 1.0 mm, or 1.5 mm with the same foot pattern)

3. “TOUGH CONTACT ADVANCED” structure adopted to ensure high resistance to various environments in spite of the ultra-slim space-saving body.

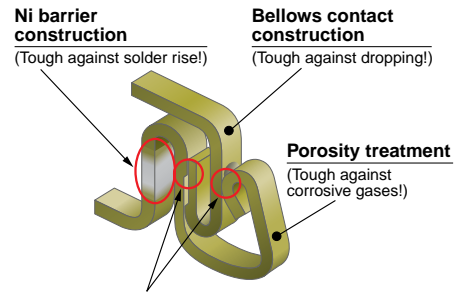

V notch and Double contact constructions (Tough against foreign particles and flux!)

- 4. The simple lock structure for high mating/unmating operation feel.
- 5. The contact at the four corners enhance the mounting strength.
- 6. The gull-wing-shaped terminals facilitate imaging inspections.

APPLICATIONS

- Particularly suitable for board-to-FPC connections in ultra-compact mobile equipment that requires size and thickness reduction and functionality enhancement

ORDERING INFORMATION

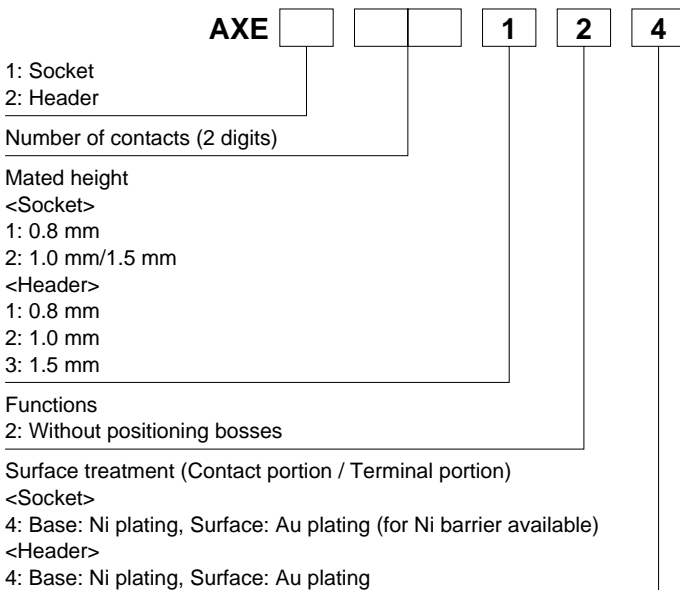

PRODUCT TYPES

Mated height	Number of contacts	Part number		Packing	
		Socket	Header	Inner carton (1-reel)	Outer carton
0.8mm	10	AXE110124	AXE210124	5,000 pieces	10,000 pieces
	14	AXE114124	AXE214124		
	20	AXE120124	AXE220124		
	24	AXE124124	AXE224124		
	30	AXE130124	AXE230124		
	36	AXE136124	AXE236124		
	40	AXE140124	AXE240124		
	50	AXE150124	AXE250124		
	60	AXE160124	AXE260124		
	70	AXE170124	AXE270124		
1.0mm	20	AXE120224	AXE220224		
	34	AXE134224	AXE234224		
	60	AXE160224	AXE260224		
	80	AXE180224	AXE280224		
1.5mm	20	AXE120324	AXE220324		
	60	AXE160324	AXE260324		
	80	AXE180324	AXE280324		

Notes: 1. Order unit:

For mass production: in 1-inner carton (1-reel) units

Samples for mounting check: in 50-connector units. Please contact our sales office.

2. The above part numbers are for connectors without positioning bosses, which are standard. When ordering connectors with positioning bosses, please contact our sales office.

3. Please contact us for connectors having a number of contacts other than those listed above.

SPECIFICATIONS

1. Characteristics

Item	Specifications	Conditions	
Electrical characteristics	Rated current	0.30A/contact (Max. 5 A at total contacts)	
	Rated voltage	60V AC/DC	
	Breakdown voltage	150V AC for 1 min.	No short-circuiting or damage at a detection current of 1 mA when the specified voltage is applied for one minute.
	Insulation resistance	Min. 1,000MΩ (initial)	Using 250V DC megger (applied for 1 min.)
	Contact resistance	Max. 90mΩ	Based on the contact resistance measurement method specified by JIS C 5402.
Mechanical characteristics	Composite insertion force	Max. 0.981N/contacts × contacts (initial)	
	Composite removal force	Min. 0.165N/contacts × contacts	
	Contact holding force (Socket contact)	Min. 0.20N/contacts	Measuring the maximum force. As the contact is axially pull out.
Environmental characteristics	Ambient temperature	-55°C to +85°C	No freezing at low temperatures. No dew condensation.
	Soldering heat resistance	Peak temperature: 260°C or less (on the surface of the PC board around the connector terminals)	Infrared reflow soldering
		300°C within 5 sec. 350°C within 3 sec.	Soldering iron
	Storage temperature	-55°C to +85°C (product only) -40°C to +50°C (emboss packing)	No freezing at low temperatures. No dew condensation.
	Thermal shock resistance (header and socket mated)	5 cycles, insulation resistance min. 100MΩ, contact resistance max. 90mΩ	Sequence 1. -55 [±] 3°C, 30 minutes 2. ~, Max. 5 minutes 3. 85 [±] 3°C, 30 minutes 4. ~, Max. 5 minutes
	Humidity resistance (header and socket mated)	120 hours, insulation resistance min. 100MΩ, contact resistance max. 90mΩ	Bath temperature 40±2°C, humidity 90 to 95% R.H.
	Saltwater spray resistance (header and socket mated)	24 hours, insulation resistance min. 100MΩ, contact resistance max. 90mΩ	Bath temperature 35±2°C, saltwater concentration 5±1%
H ₂ S resistance (header and socket mated)	48 hours, contact resistance max. 90mΩ	Bath temperature 40±2°C, gas concentration 3±1 ppm, humidity 75 to 80% R.H.	
Lifetime characteristics	Insertion and removal life	30 times	Repeated insertion and removal speed of max. 200 times/hours
Unit weight	60 contacts Socket (h = 0.8mm: 0.03g, h = 1.0/1.5mm: 0.04g) Header (h = 0.8mm: 0.01g, h = 1.0mm: 0.02g, h = 1.5mm: 0.03g)		

2. Material and surface treatment

Part name	Material	Surface treatment
Molded portion	LCP resin (UL94V-0)	—
Contact and Post	Copper alloy	Contact portion: Base: Ni plating, Surface: Au plating Terminal portion: Base: Ni plating, Surface: Au plating (except the terminal tips) The socket terminals close to the portion to be soldered have nickel barriers (exposed nickel portions). Soldering terminals: Sockets: Base: Ni plating, Surface: Pd+Au flash plating (except the terminal tips) Headers: Base: Ni plating, Surface: Au plating (except the terminal tips)

AXE1/AXE2

DIMENSIONS (Unit: mm)

Socket (Mated height: 0.8 mm)

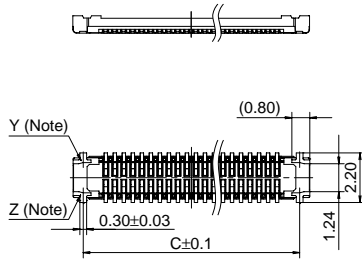
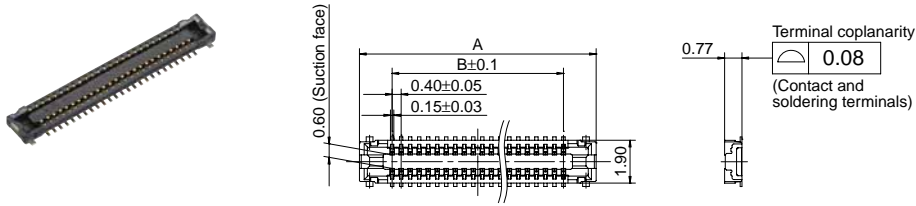

General tolerance: ± 0.2

Dimension table (mm)

Number of contacts/ dimension	A	B	C
10	4.5	1.6	3.6
14	5.3	2.4	4.4
20	6.5	3.6	5.6
24	7.3	4.4	6.4
30	8.5	5.6	7.6
36	9.7	6.8	8.8
40	10.5	7.6	9.6
50	12.5	9.6	11.6
60	14.5	11.6	13.6
70	16.5	13.6	15.6
80	18.5	15.6	17.6

Note: Since soldering terminals are built into the body, the Y and Z parts are connected electrically.

Header (Mated height: 0.8 mm)

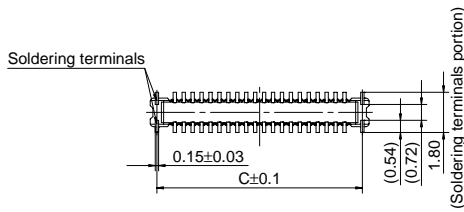
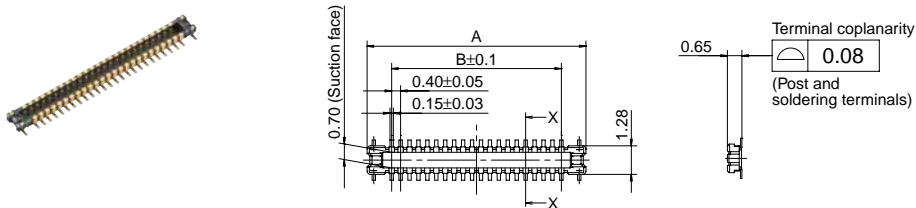

General tolerance: ± 0.2

Dimension table (mm)

Number of contacts/ dimension	A	B	C
10	3.8	1.6	3.2
14	4.6	2.4	4.0
20	5.8	3.6	5.2
24	6.6	4.4	6.0
30	7.8	5.6	7.2
36	9.0	6.8	8.4
40	9.8	7.6	9.2
50	11.8	9.6	11.2
60	13.8	11.6	13.2
70	15.8	13.6	15.2
80	17.8	15.6	17.2

Socket (Mated height: 1.0 mm and 1.5 mm)

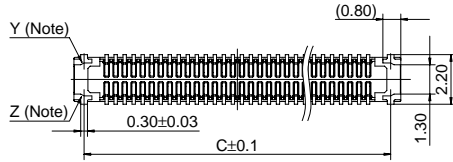
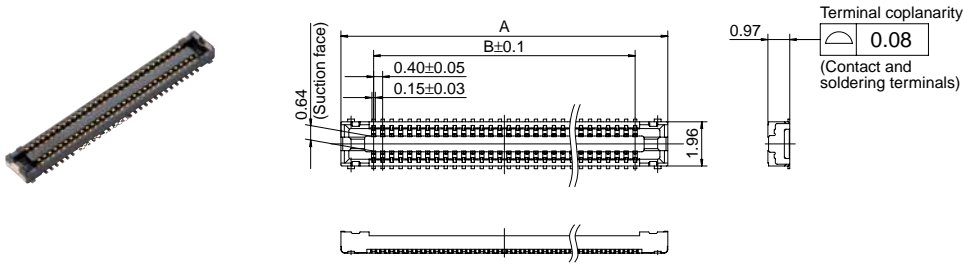

General tolerance: ±0.2

Dimension table (mm)

Number of contacts/ dimension	A	B	C
20	6.5	3.6	5.6
34	9.3	6.4	8.4
60	14.5	11.6	13.6
80	18.5	15.6	17.6

Note: Since soldering terminals are built into the body, the Y and Z parts are connected electrically.

Header (Mated height: 1.0 mm)

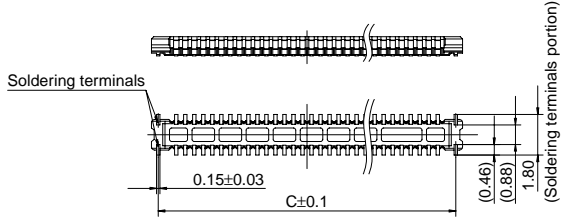
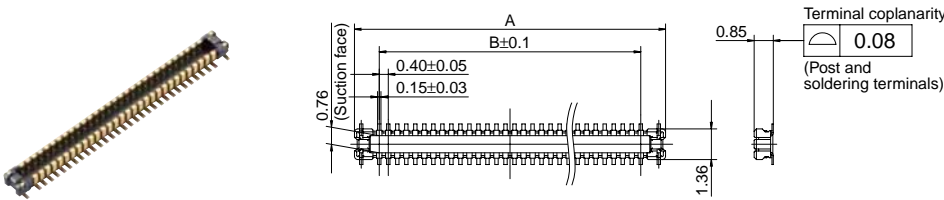

General tolerance: ±0.2

Dimension table (mm)

Number of contacts/ dimension	A	B	C
20	5.8	3.6	5.2
34	8.6	6.4	8.0
60	13.8	11.6	13.2
80	17.8	15.6	17.2

Header (Mated height: 1.5 mm)

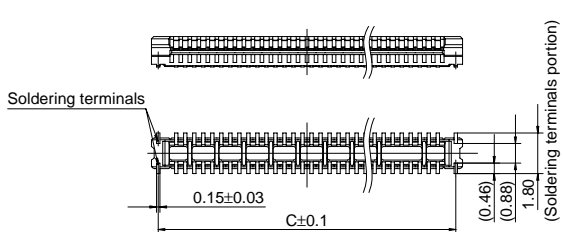
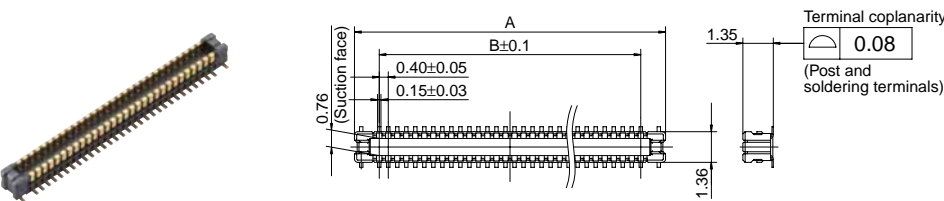

General tolerance: ±0.2

Dimension table (mm)

Number of contacts/ dimension	A	B	C
20	5.8	3.6	5.2
60	13.8	11.6	13.2
80	17.8	15.6	17.2

Socket and Header are mated

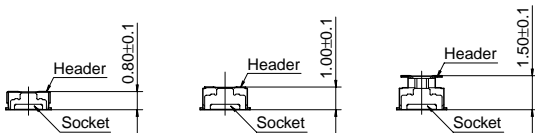

AXE1/AXE2

EMBOSSED TAPE DIMENSIONS (Unit: mm)

• Specifications for taping

(In accordance with JIS C 0806-3:1999. However, not applied to the mounting-hole pitch of some connectors.)

• Specifications for the plastic reel

(In accordance with EIAJ ET-7200B.)

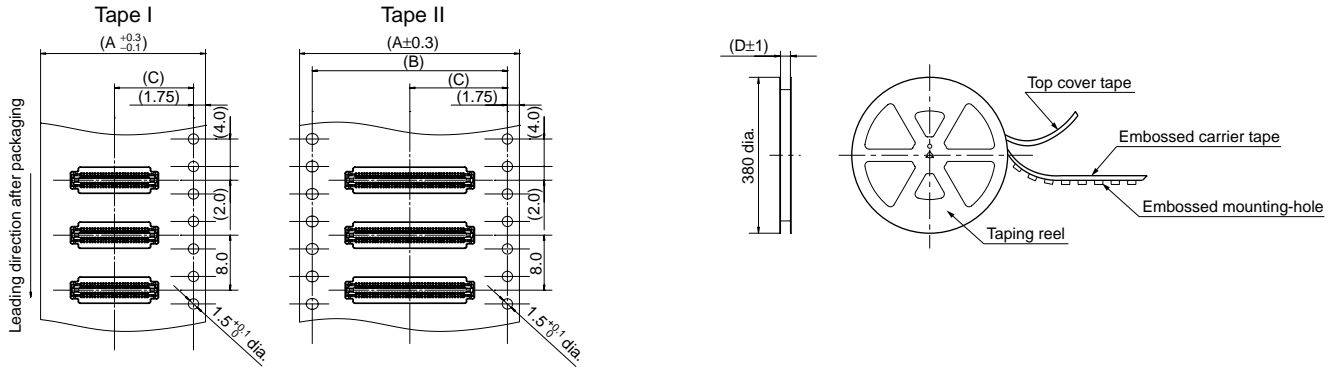

• Dimension table (Unit: mm)

Type/Mated height	Number of contacts	Type of taping	A	B	C	D	Quantity per reel
Common for sockets and headers: 0.8mm, 1.0mm and 1.5mm	Max. 24	Tape I	16.0	—	7.5	17.4	5,000
	30 to 70	Tape I	24.0	—	11.5	25.4	5,000
	80	Tape II	32.0	28.4	14.2	33.4	5,000

• Connector orientation with respect to embossed tape feeding direction

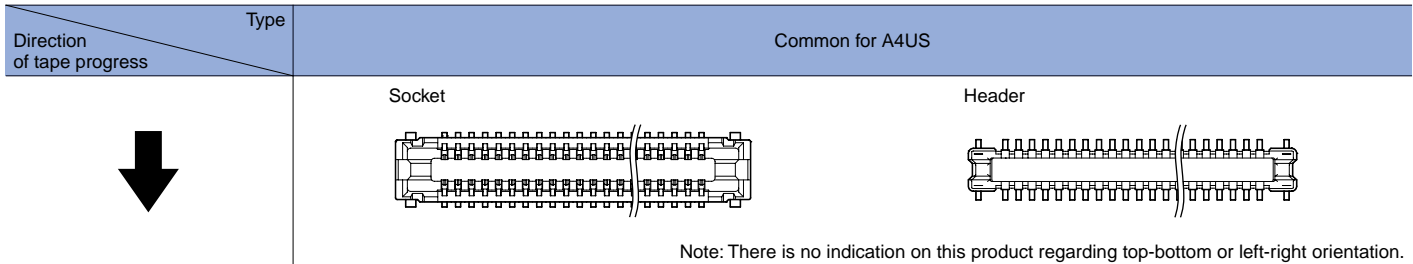

Note: There is no indication on this product regarding top-bottom or left-right orientation.

NOTES

1. Regarding the design of PC board patterns

Conduct the recommended foot pattern design, in order to preserve the mechanical strength of terminal solder areas.

2. Recommended PC board and metal mask patterns

Appropriate control of solder amount is required to minimize solder bridges and other defects for connectors with 0.35 mm, 0.4 mm or 0.5 mm pitch terminals, which require high-density mounting. Refer to the right-hand drawing for recommended patterns.

3. See the common "NOTES FOR USE" on the next page for other points to be noted.

• Socket (Mated height: 0.8 mm, 1.0 mm and 1.5 mm)

Recommended PC board pattern (TOP VIEW)

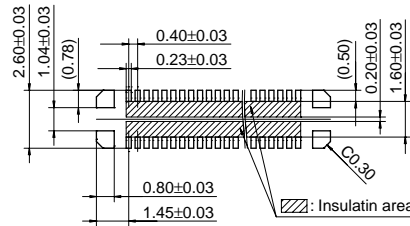

Recommended metal mask opening pattern

Metal mask thickness: When 120μm
(Terminal opening ratio: 70%)
(Metal-part opening ratio: 100%)

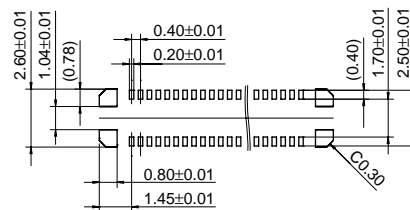

• Header (Mated height: 0.8 mm, 1.0 mm and 1.5 mm)

Recommended PC board pattern (TOP VIEW)

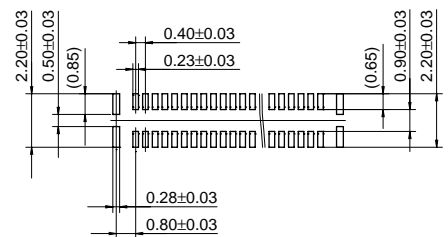

Recommended metal mask opening pattern

Metal mask thickness: When 120μm
(Terminal opening ratio: 70%)
(Metal-part opening ratio: 100%)

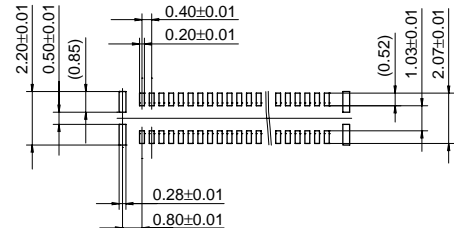

NOTES FOR USE

■ Connector mounting

When the working environment is dry, be careful for static buildup.

The buildup of static electricity occasionally causes the products to cling to the taping material. To prevent static buildup, it is recommended that you maintain the relative humidity of your working environment at 40 to 60%, while eliminating static using an ionizer or other means.

■ Soldering

1) Manual soldering.

- Due to the low profile, if an excessive amount of solder is applied to this product during manual soldering, the solder may creep up to near the contact points, or interference by solder may cause imperfect contact.
- Make sure that the soldering iron tip is heated within the temperature and time limits indicated in the specifications.
- Flux from the solder wire may adhere to the contact surfaces during soldering operations. After soldering, carefully check the contact surfaces and clean off any flux before use.
- Be aware that a load applied to the connector terminals while soldering may displace the contact.
- Thoroughly clean the iron tip.

2) Reflow soldering

- Screen-printing is recommended for printing paste solder.
 - To determine the relationship between the screen opening area and the PC-board foot pattern area, refer to the diagrams in the recommended patterns for PC boards and metal masks. Make sure to use the terminal tip as a reference position when setting.
- Avoid an excessive amount of solder from being applied, otherwise, interference by the solder will cause an imperfect contact.

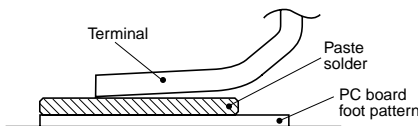

- Consult us when using a screen-printing thickness other than that recommended.
- Depending on the size of the connector being used, self alignment may not be possible. Accordingly, carefully position the terminal with the PC board pattern.

- The recommended reflow temperature profile is given in the figure below

Recommended reflow temperature profile

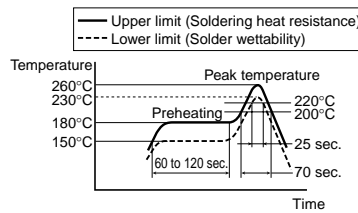

- The temperature is measured on the surface of the PC board near the connector terminal.
- Some solder and flux types may cause serious solder creeping. Take the solder and flux characteristics into consideration when setting the reflow soldering conditions.

- 3) Reworking on a soldered portion
 - Finish reworking in one operation.
 - For reworking of the solder bridge, use a soldering iron with a flat tip. Do not add flux, otherwise, the flux may creep to the contact parts.

- Use a soldering iron whose tip temperature is within the temperature range specified in the specifications.
- **Do not drop the product or handle it carelessly. Otherwise, the terminals may become deformed due to excessive force or the solderability during reflow soldering may degrade.**
- **Do not insert or remove the connector when it is not soldered. Also, forcibly applied external pressure on the terminals can weaken the adherence of the terminals to the molded part or cause the terminals to lose their evenness.**

- **Excessive prying-force applied to one end may cause product breakage and separation of the solder joints at the terminal.**
- In particular, when removing the connector, be sure not to tilt the connector exceeding 15 degrees widthwise. Excessive force applied for insertion in a pivot action as shown may also cause product breakage. Align the header and socket positions before connecting them.**

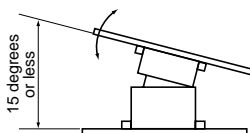

- **When cutting or bending the PC board after mounting the connector, be careful that the soldered sections are subjected to excessive forces.**

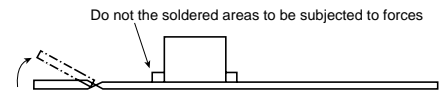

- **Notes when using a FPC.**

When the connector is soldered to an FPC board, during its insertion and removal procedures, forces may be applied to the terminals and cause the soldering to come off. It is recommended to use a reinforcement board on the backside of the FPC board to which the connector is being connected. Make sure that the reinforcing plate is larger than the outline of the recommended PC board pattern (Outline + approx. 1 mm). The reinforcing plate is made of glass epoxy or polyimide that is 0.2 to 0.3 mm thick. This connector employs a simple locking structure. However, the connector may come off depending on the size and weight of the FPC, layout and reaction force of FPC, or by drop impact. Make sure to fully check the equipment's condition. To prevent any problem with loose connectors, adopt measures to prevent the connector from coming off inside the equipment.

■ Other Notes

When coating the PC board after soldering the connector to prevent the deterioration of insulation, perform the coating in such a way so that the coating does not get on the connector. The connectors are not meant to be used for switching.

When designing the target equipment, please verify with the latest product specifications.

Narrow-pitch Connector Lineup

Narrow-pitch Connector

Search

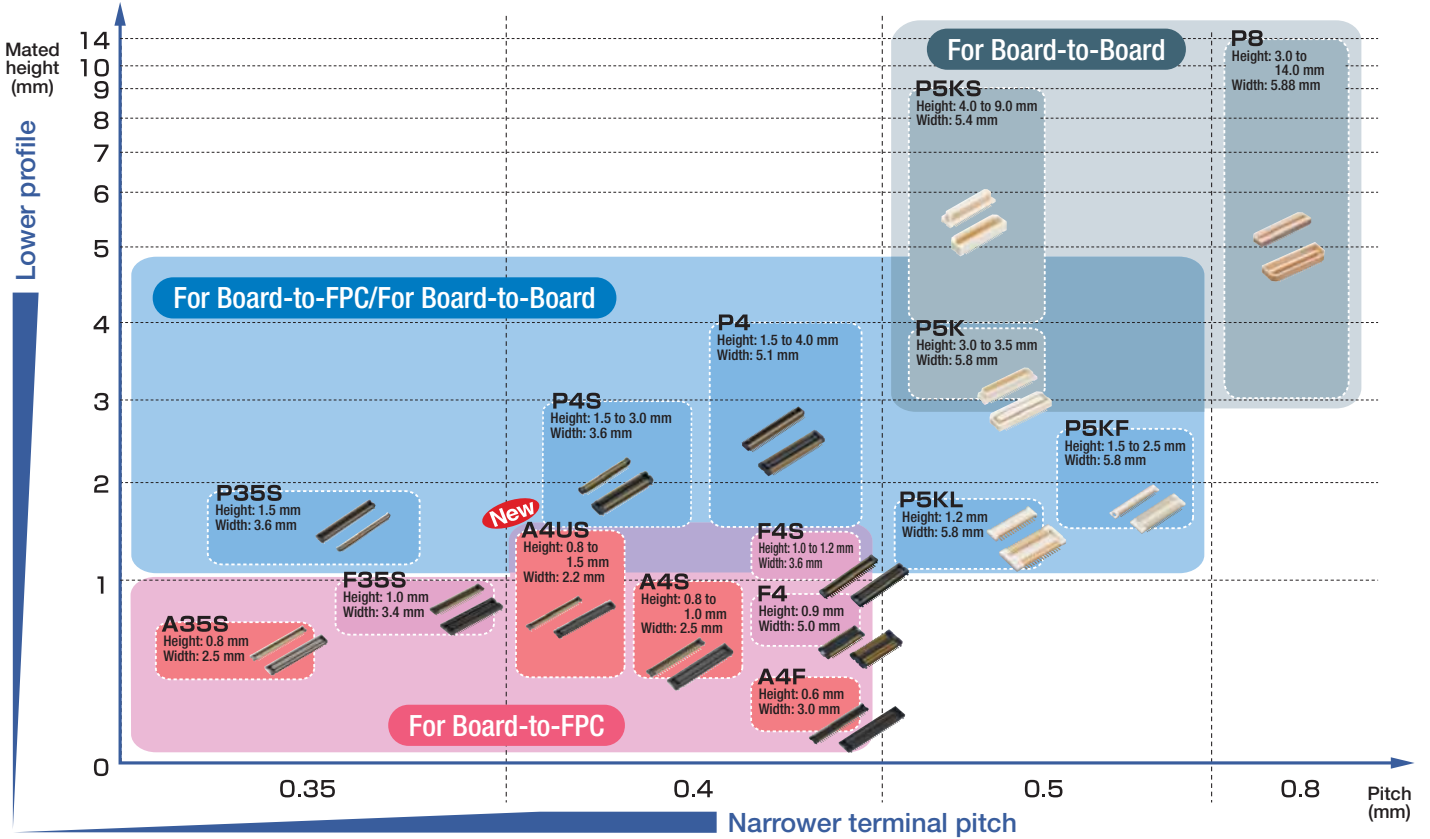

Introduction of Our Website for Dimension Search

panasonic-denko.co.jp/acc/e-size/

Connector Dimensions Search

Search

Search now!
Access now!

3D and 2D CAD data are also downloadable.



Screen image and Explanation

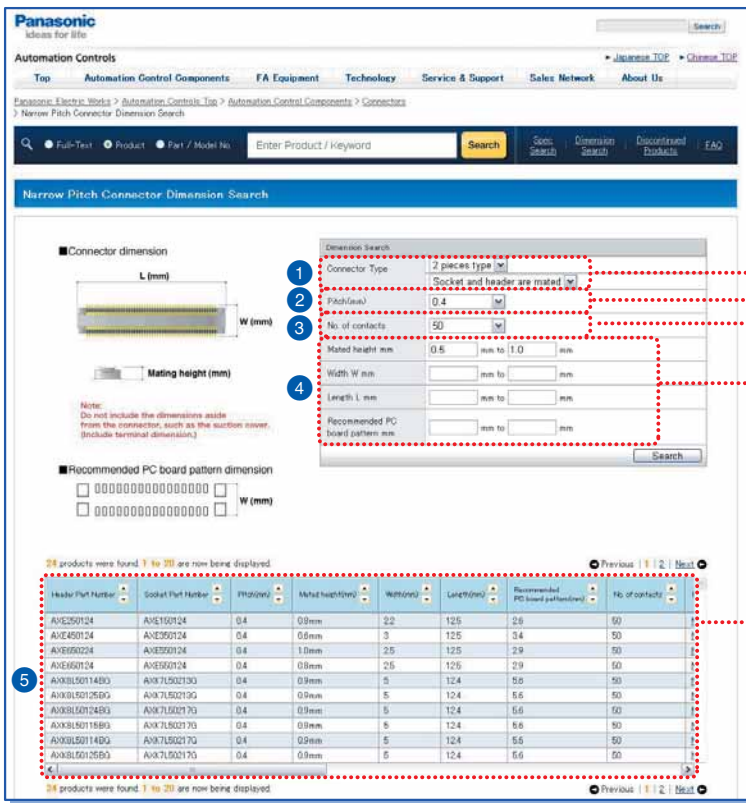

1 Connector Type

You can select "Socket and header are mated", "Socket", or "Head".

2 Pitch (mm)

You can specify the terminal pitch.

3 No. of contacts

You can specify the number of contacts.

4 Dimension criteria (required)

You can search by specifying criteria for one or more of the dimensions, which are the "Mated height", "Width", and "Length".

5 Search results

All connectors that meet the dimension criteria you entered will be listed.

* The result list can be sorted by a dimension, part number, or other criteria.

* You can add search criteria to narrow down the results.

* The above image shows a sample screen when mated connectors are selected.

Panasonic Electric Works Co., Ltd.

Automation Controls Business Unit

■ Head Office: 1048, Kadoma, Kadoma-shi, Osaka 571-8686, Japan

■ Telephone: +81-6-6908-1050 ■ Facsimile: +81-6-6908-5781

panasonic-electric-works.net/ac