

阅读申明

- 1.本站收集的数据手册和产品资料都来自互联网，版权归原作者所有。如读者和版权方有任何异议请及时告之，我们将妥善解决。
- 2.本站提供的中文数据手册是英文数据手册的中文翻译，其目的是协助用户阅读，该译文无法自动跟随原稿更新，同时也可能存在翻译上的不当。建议读者以英文原稿为参考以便获得更精准的信息。
- 3.本站提供的产品资料，来自厂商的技术支持或者使用者的心得体会等，其内容可能存在描述上的差异，建议读者做出适当判断。
- 4.如需与我们联系，请发邮件到marketing@iczoom.com，主题请标有“数据手册”字样。

Read Statement

1. The datasheets and other product information on the site are all from network reference or other public materials, and the copyright belongs to the original author and original published source. If readers and copyright owners have any objections, please contact us and we will deal with it in a timely manner.
2. The Chinese datasheets provided on the website is a Chinese translation of the English datasheets. Its purpose is for reader's learning exchange only and do not involve commercial purposes. The translation cannot be automatically updated with the original manuscript, and there may also be improper translations. Readers are advised to use the English manuscript as a reference for more accurate information.
3. All product information provided on the website refer to solutions from manufacturers' technical support or users the contents may have differences in description, and readers are advised to take the original article as the standard.
4. If you have any questions, please contact us at marketing@iczoom.com and mark the subject with "Datasheets" .

❗ Discontinued as of September 30, 2013

Panasonic
ideas for life

For board-to-board	P5KL Series
Narrow pitch connectors (0.5mm pitch)	

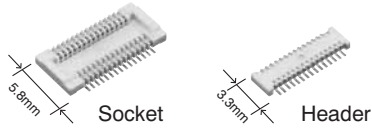

❗ Products are discontinued.

FEATURES

1. Low profile mated height of 1.2 mm and 0.5 mm pitch contributes to device miniaturization.
2. Strong resistance to adverse environments! Utilizes **TOUGH CONTACT** construction for high contact reliability.
3. Simple lock structure provides tactile feedback to ensure excellent mating/unmating operation feel.

APPLICATIONS

Digital devices, such as digital still cameras and digital video cameras.

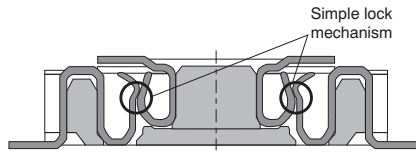

4. Effective mating length 0.3 mm

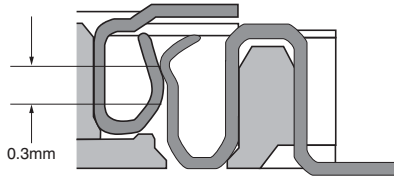

ORDERING INFORMATION

AXK	□	□	□	3	□	7	G
5L: Narrow Pitch Connector P5KL (0.5 mm pitch) Socket							
6L: Narrow Pitch Connector P5KL (0.5 mm pitch) Header							
Number of pins (2 digits)							
Mated height							
<Socket>							
3: For mated height 1.2 mm							
<Header>							
3: For mated height 1.2 mm							
Functions							
3: With positioning bosses							
4: Without positioning bosses							
Surface treatment (Contact portion / Terminal portion)							
7: Ni plating on base, Au plating on surface (for Ni barrier available)							
Packing							
G: 3,000 pieces embossed tape and plastic reel x 2 (for Ni barrier available)							

PRODUCT TYPES

Mated height	No. of pins	Part No.		Packing quantity	
		Socket	Header	Inner carton (1-reel)	Outer carton
		TOUGH CONTACT	TOUGH CONTACT		
⚠ 1.2 mm	10	AXK5L10347G	AXK6L10347G	3,000 pieces	6,000 pieces
	12	AXK5L12347G	AXK6L12347G		
	20	AXK5L20347G	AXK6L20347G		
	24	AXK5L24347G	AXK6L24347G		
	30	AXK5L30347G	AXK6L30347G		
	34	AXK5L34347G	AXK6L34347G		
	40	AXK5L40347G	AXK6L40347G		
	46	AXK5L46347G	AXK6L46347G		
	50	AXK5L50347G	AXK6L50347G		
60	AXK5L60347G	AXK6L60347G			

Notes: 1. Regarding ordering units: During production, Please make orders in 1-reel units. Samples for mounting confirmation: Please consult us. Samples: Small lot orders are possible. Please consult us.

2. The standard type comes without positioning bosses. Connectors with positioning bosses are available for on-demand production.
For this type of connector, 9th digit of the part no. changes from 4 to 3. e.g. 10 pin contacts for sockets: AXK5L10337G

SPECIFICATIONS

1. Characteristics

Item		Specifications	Conditions		
Electrical characteristics	Rated current	0.5A/pin contact (Max. 10 A at total pin contacts)			
	Rated voltage	60V AC/DC			
	Breakdown voltage	150V AC for 1 minute	Detection current: 1mA		
	Insulation resistance	Min. 1,000M Ω (initial)	Using 500V DC megger		
	Contact resistance	Max. 90m Ω	Based on the contact resistance measurement method specified by JIS C 5402.		
Mechanical characteristics	Composite insertion force	Max. 0.981N {100gf}/pin contacts \times pin contacts (initial)			
	Composite removal force	Min. 0.0588N {6gf}/pin contacts \times pin contacts			
	Holding force of terminal securing section	Min. 0.981N {100gf}/pin contact	Measuring the maximum force. As the contact is axially pull out.		
Environmental characteristics	Ambient temperature	-55°C to +85°C	No freezing at low temperatures		
	Soldering heat resistance	Max. peak temperature of 260°C (on the surface of the PC board around the connector terminals)	Infrared reflow soldering		
		300°C within 5 seconds 350°C within 3 seconds	Soldering iron		
	Storage temperature	-55°C to +85°C (product only) -40°C to +50°C (emboss packing)	No freezing at low temperatures. No dew condensation.		
	Thermal shock resistance (header and socket mated)	5 cycles, insulation resistance min. 100M Ω , contact resistance max. 90m Ω	Conformed to MIL-STD-202F, method 107G		
			Order	Temperature (°C)	Time (minutes)
			1	-55 \pm 3	30
2			{	Max. 5	
3	85 \pm 3	30			
4	{	Max. 5			
		-55 \pm 3			
Humidity resistance (header and socket mated)	120 hours, insulation resistance min. 100M Ω , contact resistance max. 90m Ω	Bath temperature 40 \pm 2°C, humidity 90 to 95% R.H.			
Saltwater spray resistance (header and socket mated)	24 hours, insulation resistance min. 100M Ω , contact resistance max. 90m Ω	Bath temperature 35 \pm 2°C, saltwater concentration 5 \pm 1%			
H ₂ S resistance (header and socket mated)	48 hours, contact resistance max. 90m Ω	Bath temperature 40 \pm 2°C, gas concentration 3 \pm 1 ppm, humidity 75 to 80% R.H.			
Lifetime characteristics	Insertion and removal life	50 times	Repeated insertion and removal speed of max. 200 times/hours		
Unit weight	20 pin contacts; Socket: 0.05g; Header: 0.02g				

2. Material and surface treatment

Part name	Material	Surface treatment
Molded portion	Heat-resistant resin (UL94V-0)	—
Contact/Post	Copper alloy	Contact portion: Ni plating on base, Au plating on surface Terminal portion: Ni plating on base, Au plating on surface (Except for thick of terminal) The section close to the soldering portion has a nickel barrier. (The nickel base is exposed.)

DIMENSIONS

Interested in CAD data? You can obtain CAD data for all products with a **CAD Data** mark from your local Panasonic Electric Works representative.

(Unit: mm)

- Socket (Mated height: 1.2mm)

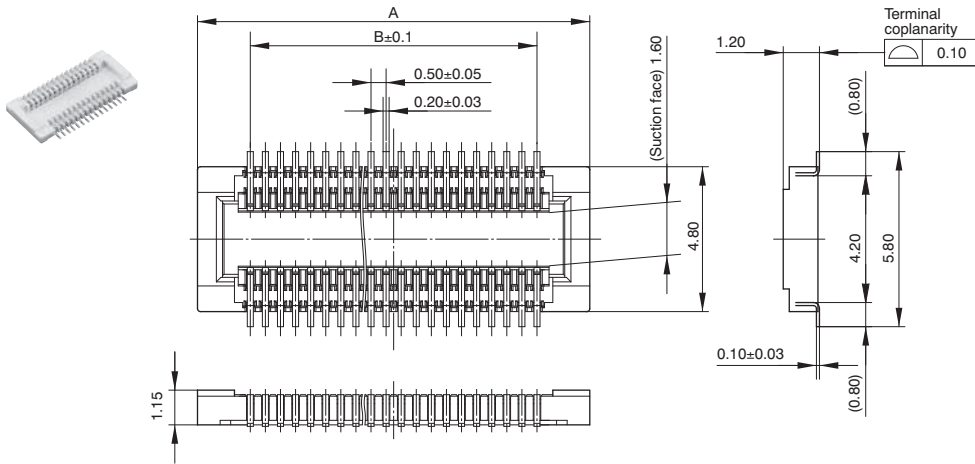

Dimension table (mm)

No. of contacts	A	B
10	5.50	2.00
12	6.00	2.50
20	8.00	4.50
24	9.00	5.50
30	10.50	7.00
34	11.50	8.00
40	13.00	9.50
46	14.50	11.00
50	15.50	12.00
60	18.00	14.50

General tolerance: ±0.2

- Header (Mated height: 1.2mm)

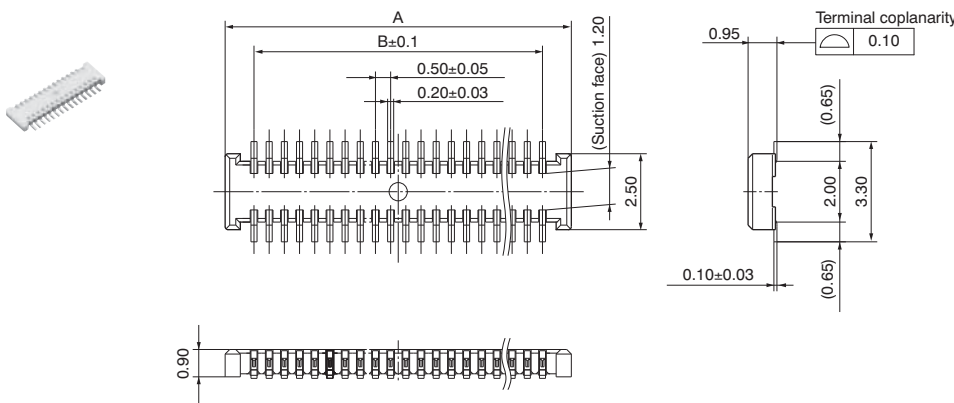

Dimension table (mm)

No. of contacts	A	B
10	3.90	2.00
12	4.40	2.50
20	6.40	4.50
24	7.40	5.50
30	8.90	7.00
34	9.90	8.00
40	11.40	9.50
46	12.90	11.00
50	13.90	12.00
60	16.40	14.50

General tolerance: ±0.2

- Socket and header are mated

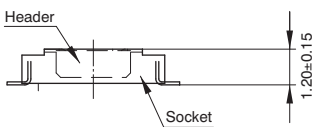

EMBOSSED TAPE DIMENSIONS (unit: mm, Common for respective contact type, socket and header)

• Tape dimensions (Conforming to JIS C 0806-1990.
However, some tapes have mounting hole pitches that do not comply with the standard.)

• Plastic reel dimensions (Conforming to EIAJ ET-7200B)

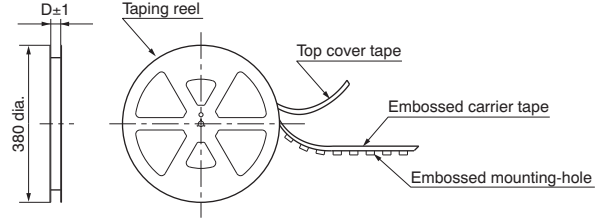
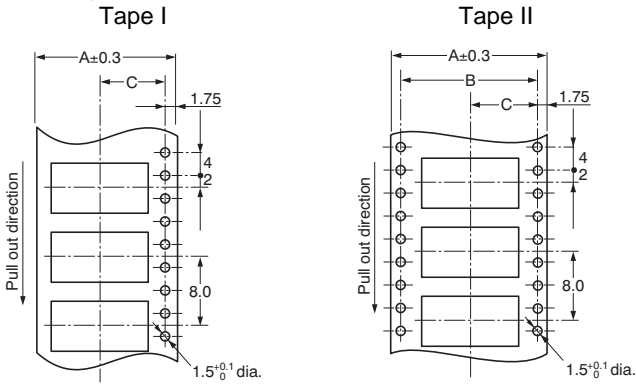

Dimension table (mm)

Suffix: G (1 reel, 3,000 pieces embossed tape: Plastic reel package)

Mated height	No. of pins	Type of taping	A	B	C	D	Quantity per reel
Socket and header are common: 1.2mm	10 to 18	Tape I	16.0	—	7.5	17.4	3,000 pcs.
	20 to 50	Tape I	24.0	—	11.5	25.4	3,000 pcs.
	60	Tape II	32.0	28.4	14.2	33.4	3,000 pcs.

Connector orientation with respect to direction of progress of embossed tape

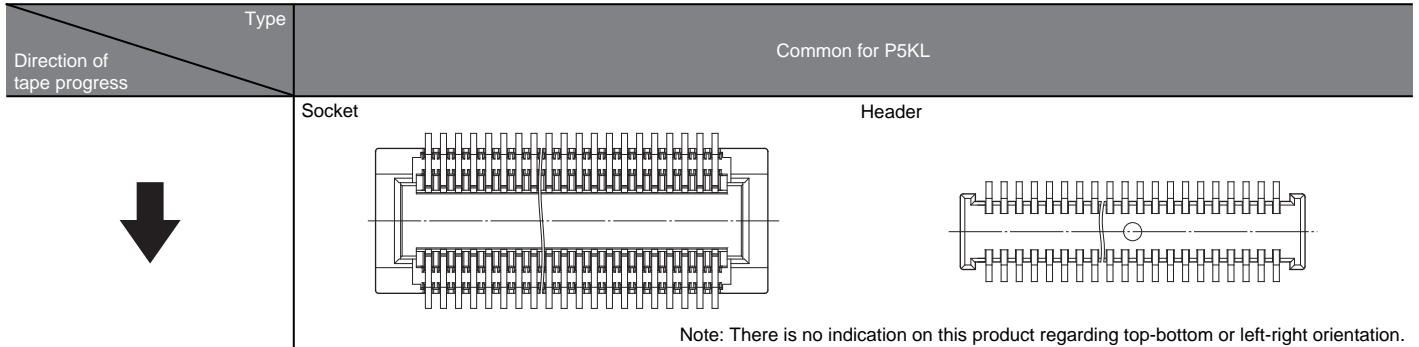

NOTES

1. As shown below, excess force during insertion may result in damage to the connector or removal of the solder. Also, to prevent connector damage please confirm the correct position before mating connectors.

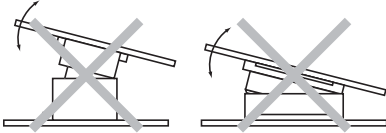

2. Keep the PC board warp no more than 0.03 mm in relation to the overall length of the connector.

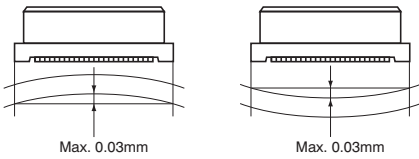

3. Recommended PC board and metal mask patterns

Connectors are mounted with high pitch density, intervals of 0.35 mm, 0.4 mm or 0.5 mm.

In order to reduce solder bridges and other issues make sure the proper levels of solder is used.

The figures to the right are recommended metal mask patterns. Please use them as a reference.

• Socket

Recommended PC board pattern (TOP VIEW)

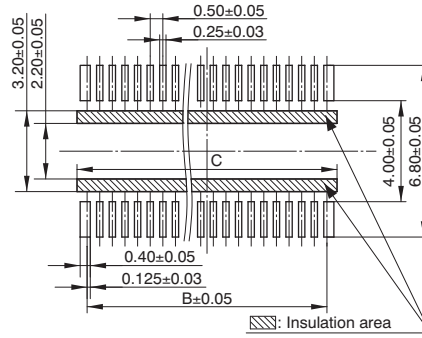

Recommended metal mask pattern
Metal mask thickness: 150 μm
(Terminal portion opening area ratio: 57%)

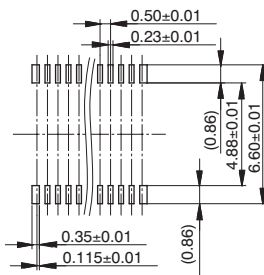

Recommended metal mask pattern
Metal mask thickness: 120 μm
(Terminal portion opening area ratio: 70%)

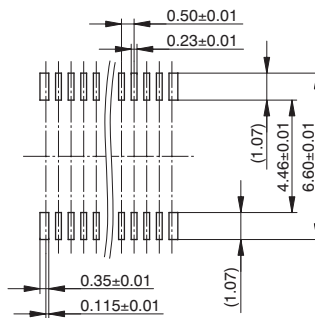

• Header

Recommended PC board pattern (TOP VIEW)

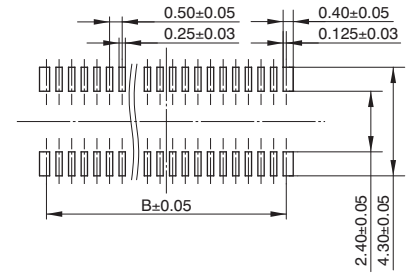

Recommended metal mask pattern
Metal mask thickness: 150 μm
(Terminal portion opening area ratio: 56%)

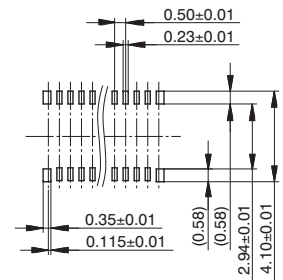

Recommended metal mask pattern
Metal mask thickness: 120 μm
(Terminal portion opening area ratio: 70%)

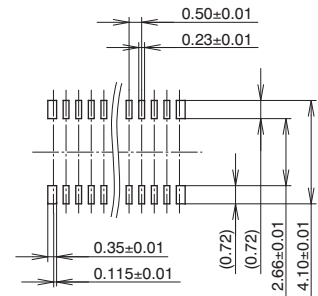

Notes: 1. See the dimension table on page 3 for more information on the B dimension of the socket and header.
2. The socket C dimension is the B dimension in the dimensions table with 0.8 added.

For Cautions for Use, see Connector Technical Information. For other details, please verify with the product specification sheets.