

## 阅读申明

- 1.本站收集的数据手册和产品资料都来自互联网，版权归原作者所有。如读者和版权方有任何异议请及时告之，我们将妥善解决。
- 2.本站提供的中文数据手册是英文数据手册的中文翻译，其目的是协助用户阅读，该译文无法自动跟随原稿更新，同时也可能存在翻译上的不当。建议读者以英文原稿为参考以便获得更精准的信息。
- 3.本站提供的产品资料，来自厂商的技术支持或者使用者的心得体会等，其内容可能存在描述上的差异，建议读者做出适当判断。
- 4.如需与我们联系，请发邮件到marketing@iczoom.com，主题请标有“数据手册”字样。

## Read Statement

1. The datasheets and other product information on the site are all from network reference or other public materials, and the copyright belongs to the original author and original published source. If readers and copyright owners have any objections, please contact us and we will deal with it in a timely manner.
2. The Chinese datasheets provided on the website is a Chinese translation of the English datasheets. Its purpose is for reader's learning exchange only and do not involve commercial purposes. The translation cannot be automatically updated with the original manuscript, and there may also be improper translations. Readers are advised to use the English manuscript as a reference for more accurate information.
3. All product information provided on the website refer to solutions from manufacturers' technical support or users the contents may have differences in description, and readers are advised to take the original article as the standard.
4. If you have any questions, please contact us at marketing@iczoom.com and mark the subject with "Datasheets" .

# Staggered Connector Directly Mounted on Board

## HIF2C Series

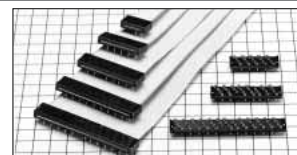
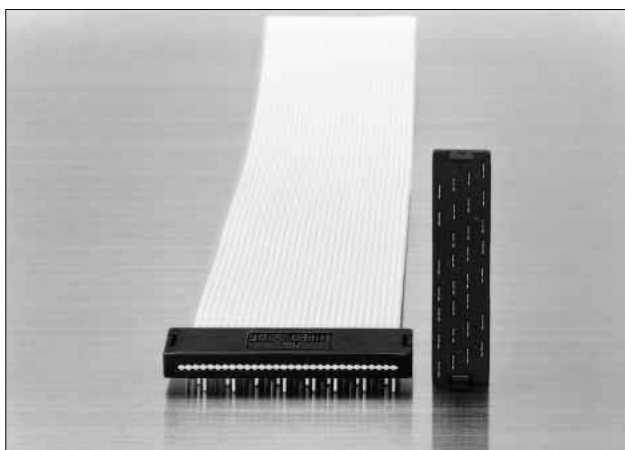

### ■ Features

1. **Directly Mounted on Board**  
 This connector can be directly mounted on the board using 1.27mm pitch flat cable.
2. **Variation in Number of Contacts**  
 The number of contacts contains 10, 16, 20, 26, 30, 34, 40, 50, and 60 contacts.
3. **Low Profile Type**  
 The connector height is lower than that of the HIF2E series.
4. **Applicable Cable**  
 The applicable cable is UL2651 AWG#28 flat cable (7 cores/.0.127mm, jacket dia. :0.8 to 1.0mm).

### ■ Applications

Computers, terminal equipment, PPC, various kinds of electronic equipment, business machines, etc.

### ■ Product Specifications

Rating	Current rating: 1A Voltage rating: 200V AC	Operating Temperature Range:-55 to +85°C (Note 1) Operating Moisture Range:40 to 80%	Storage Temperature Range:-10 to +60°C(Note 2) Storage Humidity Range:40 to 70% (Note 2)
--------	---	---	---

Item	Specification	Condition
1. Insulation Resistance	1000M ohms min.	500V DC
2. Withstanding voltage	No flashover or insulation breakdown.	650V AC/1 minute
3. Contact Resistance	15m ohms max.	0.1A
4. Vibration	No electrical discontinuity of 1μs or more	Frequency: 10 to 55 Hz, single amplitude of 0.75 mm, 2 hours in each of the 3 directions.
5. Humidity (Steady state)	Insulation resistance: 1000M ohms min.	96 hours at temperature of 40°C and humidity of 90% to 95%
6. Temperature Cycle	No damage, cracks, or parts looseness.	(-65°C: 30 minutes →15 to 35°C: 5 minutes max. 125°C: 30 minutes →15 to 35°C: 5 minutes max.) 5 cycles
7. Resistance to Soldering heat	No deformation of components affecting performance.	Solder Bath: 260°C for 10 seconds
		Manual soldering: 360°C for 5 seconds

Note 1: Includes temperature rise caused by current flow.

Note 2: The term "storage" refers to products stored for long period of time prior to mounting and use. Operating Temperature Range and Humidity range covers non conducting condition of installed connectors in storage, shipment or during transportation.

Note 3. Information contained in this catalog represents general requirements for this Series. Contact us for the drawings and specifications for a specific part number shown.

### ■ Material

Part	Material	Finish	Remarks
Insulator	PBT	Black	UL94V-0
Contact	Beryllium copper	Contact area Gold plated over nickel underplated	—

### ■ Ordering Information

**HIF2C**   -   \*   **DT**   -   **1.27**   **R**  
①   ②   ③   ④   ⑤

① Series Name: HIF 2C	④ Contact Pitch: 1.27mm
② Number of contacts: 10, 16, 20, 26, 30, 34, 40, 50, and 60	⑤ Connection type : R : ribbon cable
③ Contact alignment: DT : staggered	

HIF2C Series Staggered Connector Directly Mounted on Board

Part Number	CL No.	Number of Contacts	A	B	RoHS
HIF2C-10DT-1.27R(01)	561-0075-0-01	10	17.8	11.43	YES
HIF2C-16DT-1.27R(01)	561-0077-6-01	16	25.4	19.05	
HIF2C-20DT-1.27R(01)	561-0079-1-01	20	30.5	24.13	
HIF2C-26DT-1.27R(01)	561-0081-3-01	26	38.1	31.75	
HIF2C-30DT-1.27R(01)	561-0083-9-01	30	43.2	36.83	
HIF2C-34DT-1.27R(01)	561-0085-4-01	34	48.3	41.91	
HIF2C-40DT-1.27R(01)	561-0087-0-01	40	55.9	49.53	
HIF2C-50DT-1.27R(01)	561-0089-5-01	50	68.6	62.23	
HIF2C-60DT-1.27R(01)	561-0091-7-01	60	81.3	74.93	

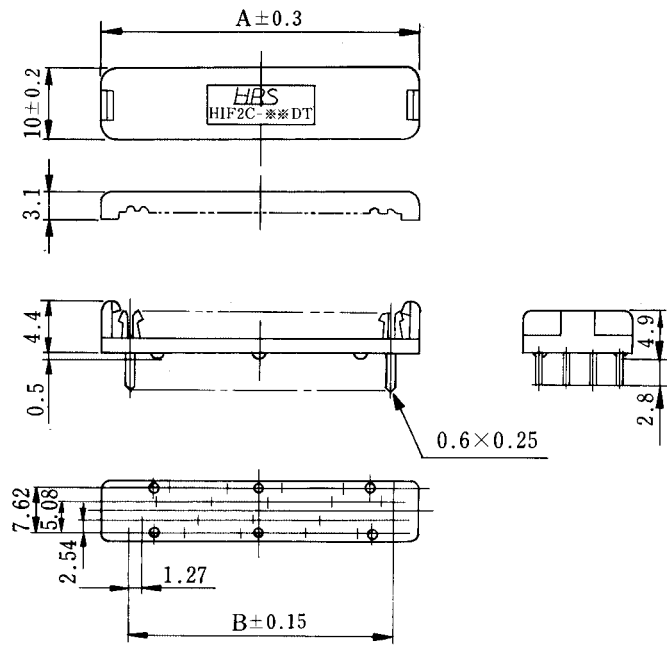

## ◆PCB mounting pattern

### 10 contacts

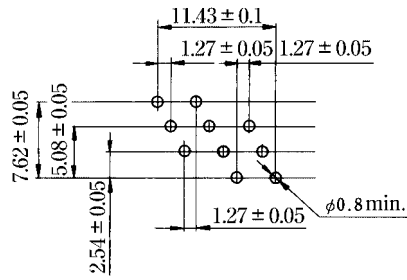

### 16 contacts

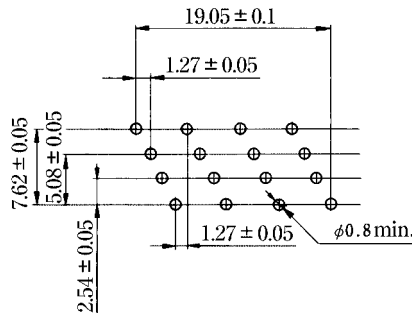

### 20 contacts

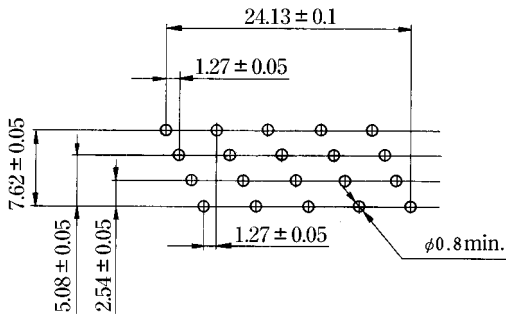

### 26 contacts

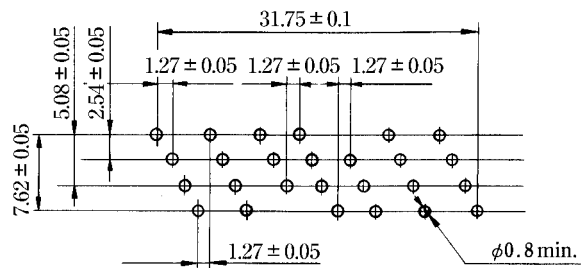

### 30 contacts

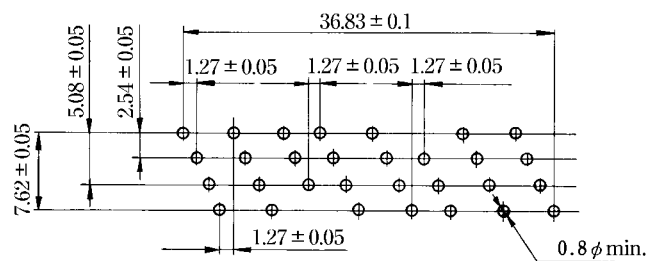

HIP2C Series Staggered Connector Directly Mounted on Board

## ◆PCB mounting pattern

### 34 contacts

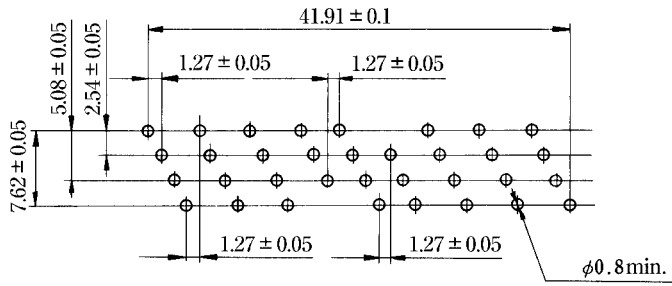

### 40 contacts

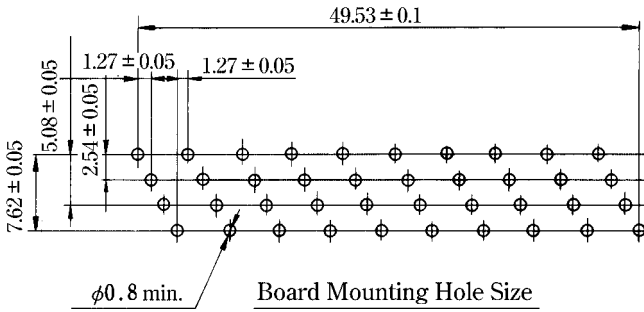

### 50 contacts

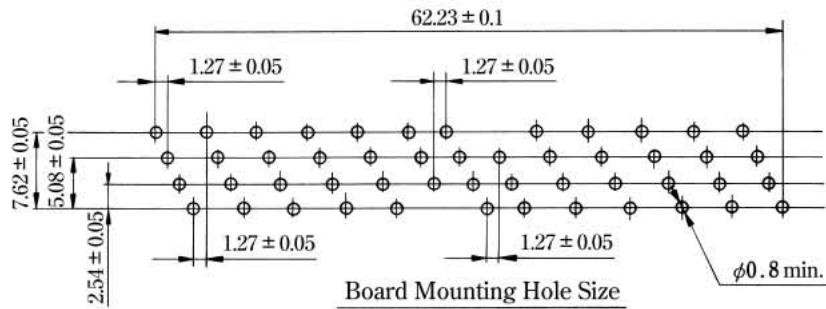

### 60 contacts

