

阅读申明

- 1.本站收集的数据手册和产品资料都来自互联网，版权归原作者所有。如读者和版权方有任何异议请及时告之，我们将妥善解决。
- 2.本站提供的中文数据手册是英文数据手册的中文翻译，其目的是协助用户阅读，该译文无法自动跟随原稿更新，同时也可能存在翻译上的不当。建议读者以英文原稿为参考以便获得更精准的信息。
- 3.本站提供的产品资料，来自厂商的技术支持或者使用者的心得体会等，其内容可能存在描述上的差异，建议读者做出适当判断。
- 4.如需与我们联系，请发邮件到marketing@iczoom.com，主题请标有“数据手册”字样。

Read Statement

1. The datasheets and other product information on the site are all from network reference or other public materials, and the copyright belongs to the original author and original published source. If readers and copyright owners have any objections, please contact us and we will deal with it in a timely manner.
2. The Chinese datasheets provided on the website is a Chinese translation of the English datasheets. Its purpose is for reader's learning exchange only and do not involve commercial purposes. The translation cannot be automatically updated with the original manuscript, and there may also be improper translations. Readers are advised to use the English manuscript as a reference for more accurate information.
3. All product information provided on the website refer to solutions from manufacturers' technical support or users the contents may have differences in description, and readers are advised to take the original article as the standard.
4. If you have any questions, please contact us at marketing@iczoom.com and mark the subject with "Datasheets" .

This document is the property of Amphenol Corporation and is delivered on the express condition that it is not to be disclosed, reproduced or used, in whole or in part, for manufacture or sale by anyone other than Amphenol Corporation without its prior consent, and that no right is granted to disclose or to use any information in this document.

The marking on this product doesn't contain environmental hazardous materials per Material Specification 55-00259 for Sony GP compliant or per directive 2011/65/EU for RoHS compliant.



ORIGINAL



REVISIONS				
SYM	ECN No.	DESCRIPTION	DATE	APPROVED
A	NE-14198	RELEASE FOR RoHS	11/06/2014	Arron Lin

NOTE:

- INSULATOR: HIGH TEMP. THERMOPLASTIC, LCP, UL 94V-0, COLOR: BLACK.
- CONTACT MATERIAL: COPPER ALLOY;
- FINISH:
CONTACT: SELECTIVE PLATING;
SOLDERING AREA: MATTE TIN 100u" MIN. OR GOLD PLATING;
UNDER PLATING: NICKEL PLATING 50 μ" THICKNESS MIN. OVERALL.
- THIS PRODUCT DOESN'T ENVIRONMENTAL HAZARDOUS MATERIALS PER DIRECTIVE 2011/65/EU FOR RoHS.
- PACKING MUST BE PER Amphenol PACKING SPECIFICATION

PART NO. G881BXX1X2KEU

No. OF CIRCUIT

CONTACT FINISH

- 0: Tin (OVERALL)
- 1: FLASH GOLD (OVERALL)
- 2: 15 u" GOLD
- 3: 30 u" GOLD

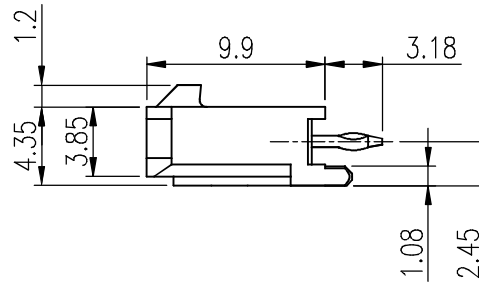
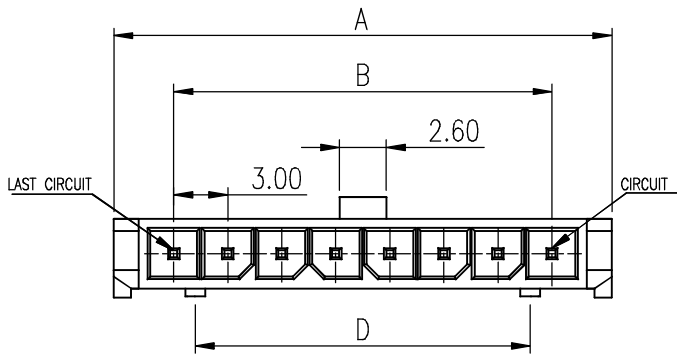
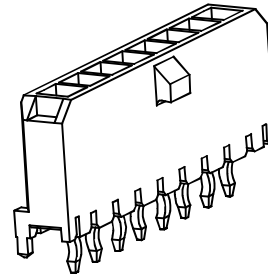
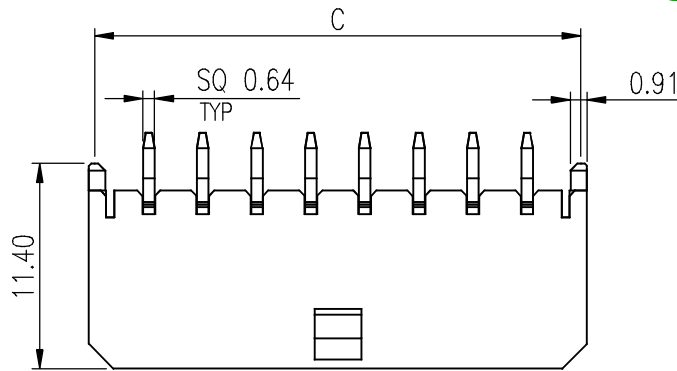

12	39.65	33.00	39.0	30.6
11	36.65	30.00	36.0	27.6
10	33.65	27.00	33.0	24.6
09	30.65	24.00	30.0	21.6
08	27.65	21.00	27.0	18.6
07	24.65	18.00	24.0	15.6
06	21.65	15.00	21.0	12.6
05	18.65	12.00	18.0	9.6
04	15.65	9.00	15.0	6.6
03	12.65	6.00	12.0	1.9
02	9.65	3.00	9.0	1.9
POS	A	B	C	D

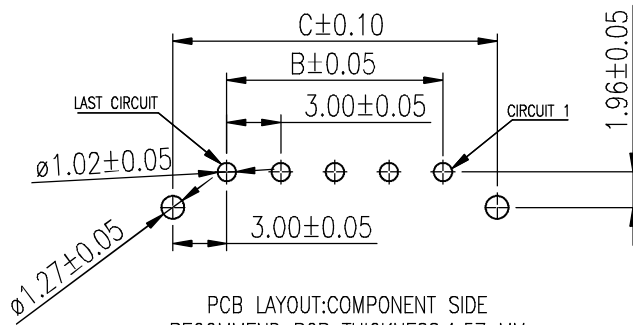

PCB LAYOUT: COMPONENT SIDE
RECOMMEND PCB THICKNESS: 1.57 MM

TOLERANCE	APPROVALS	DATE
X. ±0.30	DRAWN Debby Hung	11/06/2014
X.X ±0.20	CHECKED Roger Tsai	11/06/2014
X.XX ±0.10	APPROVED Arron Lin	11/06/2014
ANGULAR ±1°	DWG TYPE CUST DWG	PROJECT CODE PHD
UNLESS OTHERWISE SPECIFIED		

TITLE		UNIT	SIZE
G881B SERIES MICRO POWER WAFER 3.00 MM PITCH STRAIGHT S/R W/KINK TYPE		mm	A3
SCALE	SHEET	1 OF 3	
NA			

Amphenol [®]	
Amphenol Corporation Amphenol Taiwan Corporation	
PART No.	G881BXX1X2KEU
DWG No.	G881BXX1X2KEU
REV.	A

This document is the property of Amphenol Corporation and is delivered on the express condition that it is not to be disclosed, reproduced or used in whole or in part, for manufacture or sale by anyone other than Amphenol Corporation without its prior consent, and that no right is granted to disclose or to use any information in this document.

The marking on this product doesn't contain environmental hazardous materials per Material Specification SS-00259 for Sony GP compliant or per directive 2011/65/EU for RoHS compliant.



ORIGINAL



REVISIONS				
SYM	ECN No.	DESCRIPTION	DATE	APPROVED
A	NE-14198	RELEASE FOR RoHS	11/06/2014	Arron Lin

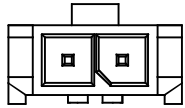

2 POS

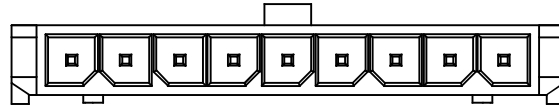

9 POS

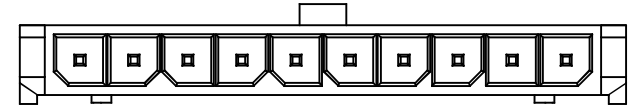

10 POS

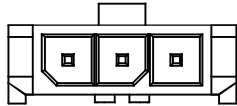

3 POS

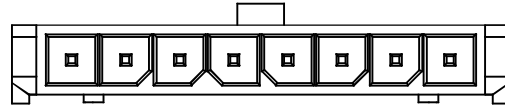

8 POS

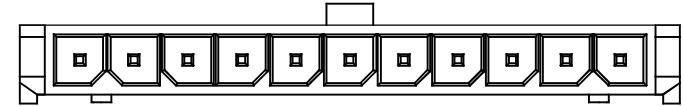

11 POS

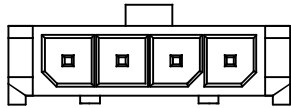

4 POS

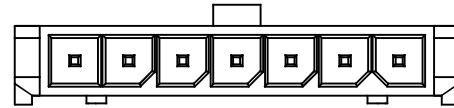

7 POS

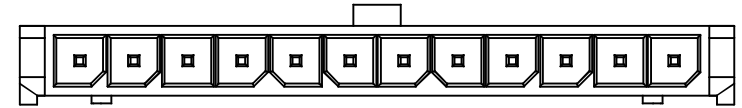

12 POS

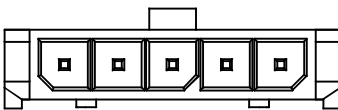

5 POS

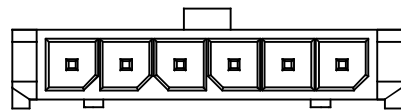

6 POS

TOLERANCE X. ±0.30 X.X ±0.20 X.XX ±0.10 X.XXX ANGULAR ±1° UNLESS OTHERWISE SPECIFIED	APPROVALS DRAWN Debby Hung CHECKED Roger Tsai APPROVED Arron Lin	DATE 11/06/2014 11/06/2014 11/06/2014	TITLE G881B SERIES MICRO POWER WAFER 3.00 MM PITCH STRAIGHT S/R W/KINK TYPE			Amphenol [®] Amphenol Corporation Amphenol Taiwan Corporation		
	DWG TYPE CUST DWG	PROJECT CODE PHD		UNIT mm SCALE NA	SIZE A3 SHEET 2 OF 3	PART No. G881BXX1X2KEU		
					DWG No. G881BXX1X2KEU		REV. A	

This document is the property of Amphenol Corporation and is delivered on the express condition that it is not to be disclosed, reproduced or used in whole or in part, for manufacture or sale by anyone other than Amphenol Corporation without its prior consent, and that no right is granted to disclose or to use any information in this document.

The marking on this product doesn't contain environmental hazardous materials per Material Specification SS-00259 for Sony GP compliant or per directive 2011/65/EU for RoHS compliant.



ORIGINAL



REVISIONS				
SYM	ECN No.	DESCRIPTION	DATE	APPROVED
A	NE-14198	RELEASE FOR RoHS	11/06/2014	Arron Lin



TRAY BOTTOM COVER

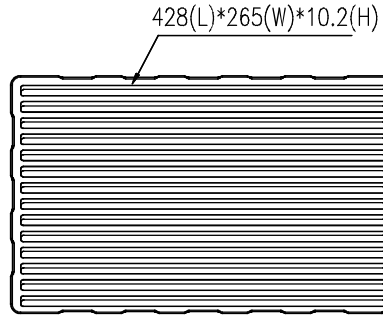

TRAY TOP COVER

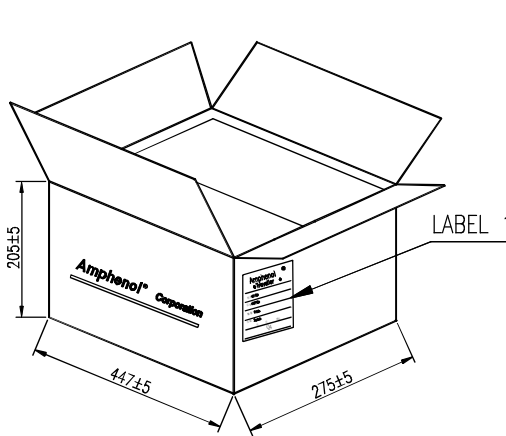
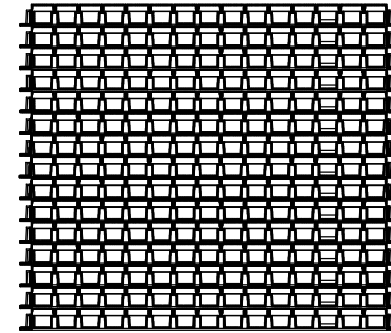

(15 TRAYS / CARTON)

POS	PCS/TRAY	PCS/CARTON
02	770	11550
03	600	9000
04	550	8250
05	500	7500
06	450	6750
07	400	6000
08	320	4800
09	280	4200
10	250	3750
11	220	3300
12	180	2700

TOLERANCE	APPROVALS	DATE	TITLE			Amphenol [®]		
X. ±0.30	DRAWN Debby Hung	11/06/2014	G881B SERIES MICRO POWER WAFER 3.00 MM PITCH STRAIGHT S/R W/KINK TYPE			Amphenol Corporation Amphenol Taiwan Corporation		
X.X ±0.20	CHECKED Roger Tsai	11/06/2014						
X.XXX ±0.10	APPROVED Arron Lin	11/06/2014						
ANGULAR ±1°	DWG TYPE CUST DWG	PROJECT CODE PHD	UNIT mm	SIZE A3	PART No. G881BXX1X2KEU			
UNLESS OTHERWISE SPECIFIED			SCALE NA	SHEET 3 OF 3	DWG No. G881BXX1X2KEU		REV. A	