

## 阅读申明

- 1.本站收集的数据手册和产品资料都来自互联网，版权归原作者所有。如读者和版权方有任何异议请及时告之，我们将妥善解决。
- 2.本站提供的中文数据手册是英文数据手册的中文翻译，其目的是协助用户阅读，该译文无法自动跟随原稿更新，同时也可能存在翻译上的不当。建议读者以英文原稿为参考以便获得更精准的信息。
- 3.本站提供的产品资料，来自厂商的技术支持或者使用者的心得体会等，其内容可能存在描述上的差异，建议读者做出适当判断。
- 4.如需与我们联系，请发邮件到marketing@iczoom.com，主题请标有“数据手册”字样。

## Read Statement

1. The datasheets and other product information on the site are all from network reference or other public materials, and the copyright belongs to the original author and original published source. If readers and copyright owners have any objections, please contact us and we will deal with it in a timely manner.
2. The Chinese datasheets provided on the website is a Chinese translation of the English datasheets. Its purpose is for reader's learning exchange only and do not involve commercial purposes. The translation cannot be automatically updated with the original manuscript, and there may also be improper translations. Readers are advised to use the English manuscript as a reference for more accurate information.
3. All product information provided on the website refer to solutions from manufacturers' technical support or users the contents may have differences in description, and readers are advised to take the original article as the standard.
4. If you have any questions, please contact us at marketing@iczoom.com and mark the subject with "Datasheets" .

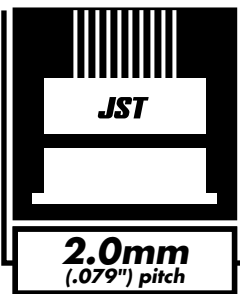

# PA FAMILY SERIES/PA•PAF•PAL CONNECTOR

Wire-to-board (Crimp style/IDC) / Wire-to-wire (Crimp style/IDC)

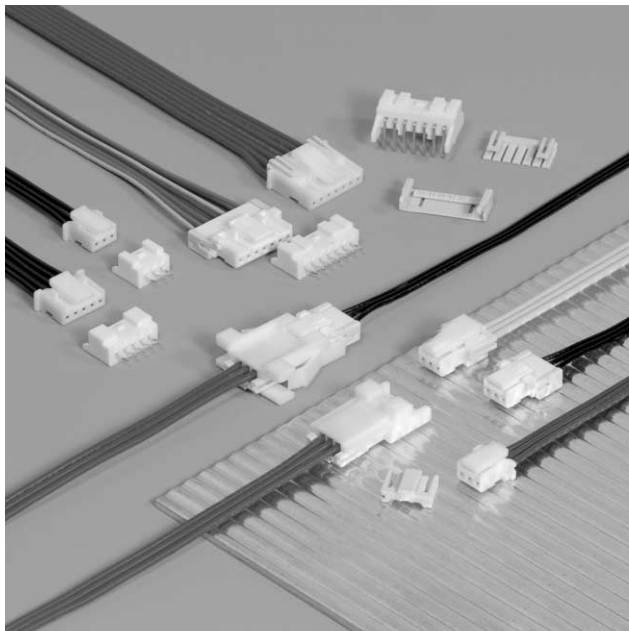

**Based upon wire-to-board crimp style PA connectors, the PA series family of connector have been expanded to meet the requirement of complex wire harness of 2.0mm (.079") pitch connectors with secure locking mechanism thanks to the additional line up of wire-to-board IDC style PAF connectors and wire-to-wire crimp style PAL connectors.**

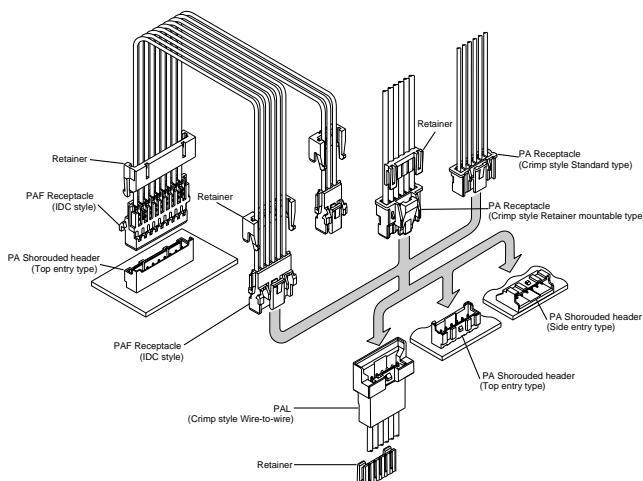

- \* Contact JST if Lead-Free product is required.
- \* Refer to "General Instruction and Notice when using Terminals and Connectors" at the end of this catalog.
- \* Contact JST for details.

## Standards

Recognized E60389

Certified LR20812

## Features

### • Secure locking device

The housing has a locking device to prevent accidental disconnection because of routing of wires or of vibration, and also reverse and different circuit numbers mating.

### • Interchangeable between crimp and IDC socket

Both crimp and IDC sockets use the same headers and wire-to-wire mating halves.

### • Secondary retainers

Secondary retainers enhance safety in case of partial insertion or accidental release of the contact.

### • Harness variation

PAL, wire-to-wire crimp style connector, increases wire harness variation.

### PA connector (Standard type, Retainer mountable type)

### • Highly reliable contact

The box contact supplies stable contact performance even under conditions of vibration, distortion, low voltage or low current.

### • Insertion guide mechanism

Header has housing insertion guides for easy and secure insertion.

### • Flanged press pin

Top entry type header has flanged press pins, preventing accidental removal of the pins that might result from the distorted unmating especially in the case of small No. of circuits.

### PAF connector

### • The industry's first secure lock IDC connectors

By separating ID section and secure lock section, the industry's first secure lock specification has been achieved for IDC that was said to be impossible. Our fully automatic IDC machines, BCD-M5BP (for simple harness) and CAM-M12B, SAD-M12E (for multi-harness), can be applied for harness making.

### • Metallic strain relief

Metallic strain relief on the contact securely grips wire insulation that can avoid direct stress of vibration or impact. The same grip strength as insulation barrel of crimp style contact could be achieved.

### • Retainer with four locking points

The new four locking points design ensures wire retention force of every direction that is almost superior to contact retention force of crimp style connectors. It also completely covers exposed terminated ID contact.

### PAL connector

### • The industry's first wire to wire 2.0mm (.079") pitch retainer mountable type connector.

### • Either with or without panel lock can be selected according to application.

# PA FAMILY SERIES /PA•PAF•PAL CONNECTOR

## List of combinations

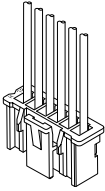
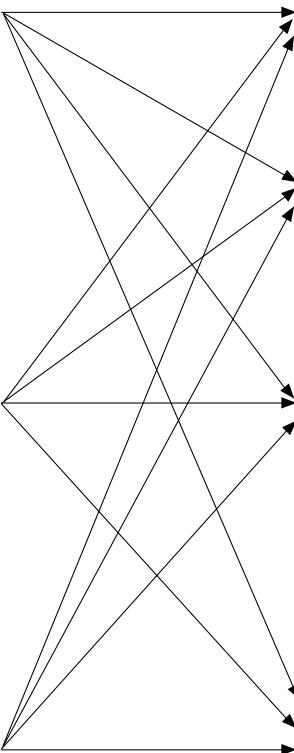
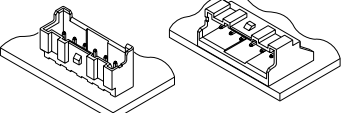
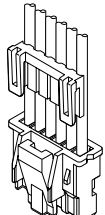
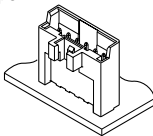
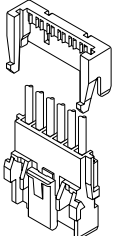
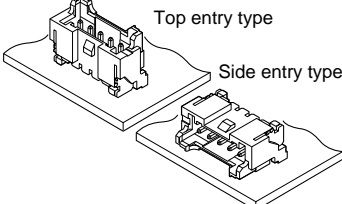
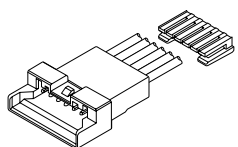
<p>Crimp style Standard type</p> 	<p><u>Contact</u> SPHD-001T-P0.5 SPHD-002T-P0.5</p> <p><u>Housing</u> PAP-( )V-S</p>		<p><u>Shrouded header</u> B( )B-PASK B( )B-PASK-1 S( )B-PASK-2</p>	<p>Top entry type      Side entry type</p> 
<p>Crimp style Retainer mountable type</p> 	<p><u>Contact</u> SPA-001T-P0.5</p> <p><u>Housing</u> PARP-( )V</p> <p><u>Retainer</u> PMS-( )V-S</p>		<p><u>Shrouded header</u> BH( )B-PASK BH( )B-PASK-1</p>	<p>High box type</p> 
<p>Insulation displacement type</p> 	<p><u>Receptacle</u> ( )PAF-6S</p> <p><u>Retainer</u> PAFS-( )V-S</p>		<p><u>Shrouded header</u> BM( )B-PASS BM( )B-PASS-1 SM( )B-PASS SM( )B-PASS-1</p>	<p>SMT type</p> <p>Top entry type      Side entry type</p> 
			<p><u>Contact</u> SPAL-001T-P0.5 SPAL-002T-P0.5</p> <p><u>Receptacle housing</u> PALR-( )V(F)</p> <p><u>Retainer</u> PMS-( )V-S</p>	<p>Wire to wire Connectors</p> 

## Specifications

### PA Connector (Standard type)

- Current rating: 3A AC, DC (AWG#22)
- Voltage rating: 250V AC, DC
- Temperature range: -25°C to +85°C  
(including temperature rise in applying electrical current)
- Contact resistance: Initial value/10m Ω max.  
After environmental testing/20m Ω max.
- Insulation resistance: 1,000M Ω min.
- Withstanding voltage: 800V AC/minute
- Applicable wire: AWG #28 to #22
- Applicable PC board thickness: 1.6mm(.063")

### PA Connector (Retainer mountable type)

- Current rating: 3A AC, DC (AWG#22)
- Voltage rating: 100V AC, DC
- Temperature range: -25°C to +85°C  
(including temperature rise in applying electrical current)
- Contact resistance: Initial value/15m Ω max.  
After environmental testing/25m Ω max.
- Insulation resistance: 1,000M Ω min.
- Withstanding voltage: 800V AC/minute
- Applicable wire: AWG #28 to #22

### PAF Connector

- Current rating: 1.0A AC, DC (AWG#26)
- Voltage rating: 100V AC, DC
- Temperature range: -25°C to +85°C  
(including temperature rise in applying electrical current)
- Contact resistance: Initial value/15m Ω max.  
After environmental testing/25m Ω max.
- Insulation resistance: 1,000M Ω min.
- Withstanding voltage: 800V AC/minute
- Applicable wire: UL1061(Contact JST for details regarding other UL wires.)  
AWG #26  
Conductor/7 strands, tin-coated annealed copper  
Insulation O.D./0.9 to 1.0mm(.035" to .039")

### PAL Connector

- Current rating: 3A AC, DC (AWG#22)
- Voltage rating: 100V AC, DC
- Temperature range: -25°C to +85°C  
(including temperature rise in applying electrical current)
- Contact resistance: Initial value/15m Ω max.  
After environmental testing/25m Ω max.
- Insulation resistance: 1,000M Ω min.
- Withstanding voltage: 800V AC/minute
- Applicable wire: AWG #28 to #22
- Applicable panel thickness : 0.5 to 2.0mm(.020" to .079")

# PA FAMILY SERIES /PA CONNECTOR (Crimp style Standard type)

## Contact

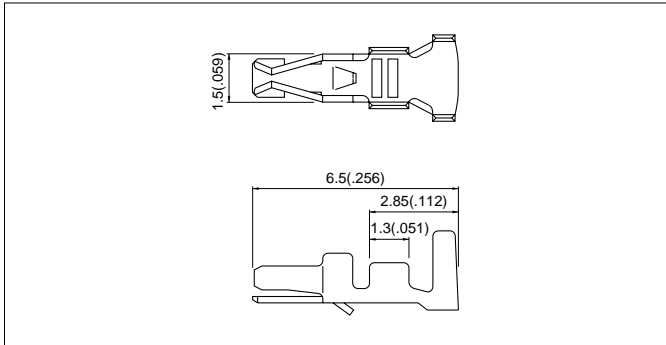

Model No.	Applicable wire			Q'ty / reel
	mm <sup>2</sup>	AWG #	Insulation O.D. mm(in.)	
<b>SPHD-001T-P0.5</b>	0.13 to 0.33	26 to 22	1.0 to 1.5(.039 to .059)	8,000
<b>SPHD-002T-P0.5</b>	0.08 to 0.21	28 to 24	0.9 to 1.5(.035 to .059)	

### Material and Finish

Phosphor bronze, tin-plated

## Housing

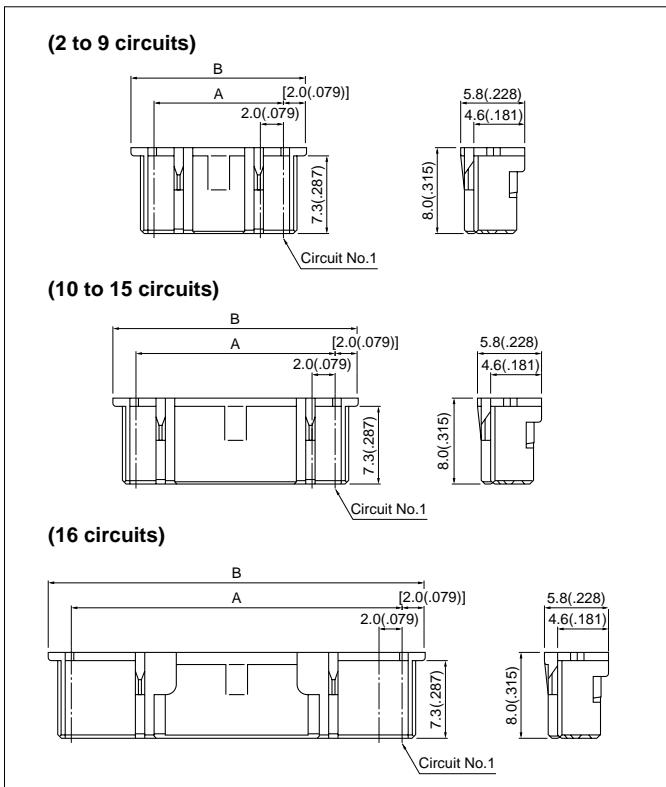

Circuits	Model No.	Dimensions mm(in.)		Q'ty / bag
		A	B	
2	<b>PAP-02V-S</b>	2.0(.079)	6.0(.236)	5,000
3	<b>PAP-03V-S</b>	4.0(.157)	8.0(.315)	5,000
4	<b>PAP-04V-S</b>	6.0(.236)	10.0(.394)	5,000
5	<b>PAP-05V-S</b>	8.0(.315)	12.0(.472)	5,000
6	<b>PAP-06V-S</b>	10.0(.394)	14.0(.551)	1,000
7	<b>PAP-07V-S</b>	12.0(.472)	16.0(.630)	1,000
8	<b>PAP-08V-S</b>	14.0(.551)	18.0(.709)	1,000
9	<b>PAP-09V-S</b>	16.0(.630)	20.0(.787)	1,000
10	<b>PAP-10V-S</b>	18.0(.709)	22.0(.866)	1,000
11	<b>PAP-11V-S</b>	20.0(.787)	24.0(.945)	1,000
12	<b>PAP-12V-S</b>	22.0(.866)	26.0(1.024)	1,000
13	<b>PAP-13V-S</b>	24.0(.945)	28.0(1.102)	1,000
14	<b>PAP-14V-S</b>	26.0(1.024)	30.0(1.181)	1,000
15	<b>PAP-15V-S</b>	28.0(1.102)	32.0(1.260)	1,000
16	<b>PAP-16V-S</b>	30.0(1.181)	34.0(1.339)	1,000

### Material

Nylon 66, UL94V-0, natural (white)

<For reference> As the color identification, the following alphabet shall be put in the underlined part.  
For availability, delivery and minimum order quantity, contact JST.

ex. **PAP-02V-S**

S...natural (white)

K...black R...red E...blue M...green O...orange N...brown

P...purple PK...pink Y...yellow L...lemon yellow FY...vivid yellow

LE...light blue H...gray TR...tomato red

# PA FAMILY SERIES /PA CONNECTOR (Crimp style Standard type)

## Through-hole type shrouded header

### Top entry type

(2 to 9 circuits)

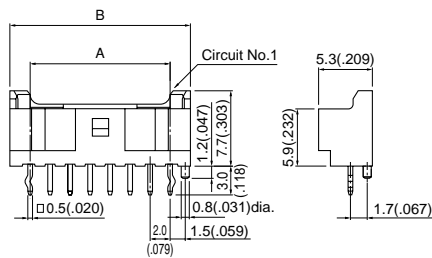

(10 to 15 circuits)

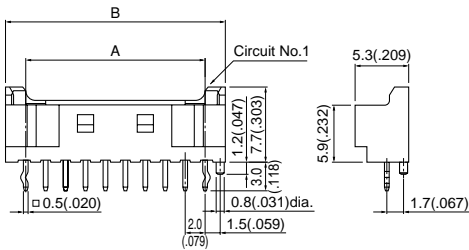

(16 circuits)

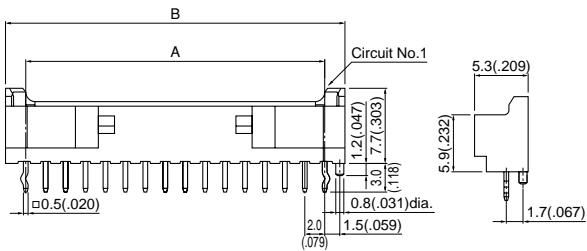

Circuits	Model No.		Dimensions mm(in.)		Q'ty / box
	Without a boss	With a boss	A	B	
2 (Note1)	<b>B02B-PAFYK-A</b>	<b>B02B-PAFYK-1A</b>	2.0(.079)	6.0(.236)	1,000
2	<b>B02B-PASK</b>	<b>B02B-PASK-1</b>	2.0(.079)	6.0(.236)	1,000
3	<b>B03B-PASK</b>	<b>B03B-PASK-1</b>	4.0(.157)	8.0(.315)	1,000
4	<b>B04B-PASK</b>	<b>B04B-PASK-1</b>	6.0(.236)	10.0(.394)	1,000
5	<b>B05B-PASK</b>	<b>B05B-PASK-1</b>	8.0(.315)	12.0(.472)	500
6	<b>B06B-PASK</b>	<b>B06B-PASK-1</b>	10.0(.394)	14.0(.551)	500
7	<b>B07B-PASK</b>	<b>B07B-PASK-1</b>	12.0(.472)	16.0(.630)	500
8	<b>B08B-PASK</b>	<b>B08B-PASK-1</b>	14.0(.551)	18.0(.709)	500
9	<b>B09B-PASK</b>	<b>B09B-PASK-1</b>	16.0(.630)	20.0(.787)	500
10	<b>B10B-PASK</b>	<b>B10B-PASK-1</b>	18.0(.709)	22.0(.866)	500
11	<b>B11B-PASK</b>	<b>B11B-PASK-1</b>	20.0(.787)	24.0(.945)	250
12	<b>B12B-PASK</b>	<b>B12B-PASK-1</b>	22.0(.866)	26.0(1.024)	250
13	<b>B13B-PASK</b>	<b>B13B-PASK-1</b>	24.0(.945)	28.0(1.102)	250
14	<b>B14B-PASK</b>	<b>B14B-PASK-1</b>	26.0(1.024)	30.0(1.181)	250
15	<b>B15B-PASK</b>	<b>B15B-PASK-1</b>	28.0(1.102)	32.0(1.260)	250
16	<b>B16B-PASK</b>	<b>B16B-PASK-1</b>	30.0(1.181)	34.0(1.339)	250

### Material and Finish

Post: Copper alloy, copper-undercoated, tin/lead-plated

Wafer: Glass-filled PBT, UL94V-0, natural (white)

(Note1) Nylon 66, UL94V-0, vivid yellow

<For reference> As the color identification, the following alphabet shall be put in the underlined part. For availability, delivery and minimum order quantity, contact JST.

ex. **B02B-PASK**

S...natural (white)

K...black R...red E...blue M...green O...orange N...brown

P...purple PK...pink Y...yellow L...lemon yellow FY...vivid yellow

LE...light blue H...gray TR...tomato red

# PA FAMILY SERIES /PA CONNECTOR (Crimp style Standard type)

## Through-hole type shrouded header

### Side entry type

(2 to 9 circuits)

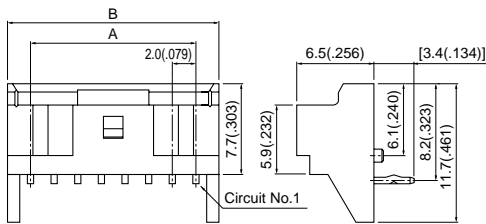

(10 to 15 circuits)

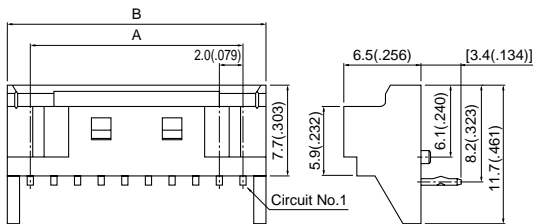

(16 circuits)

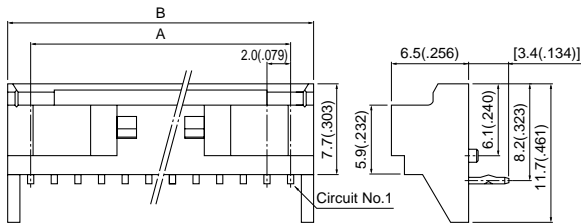

Circuits	Model No.	Dimensions mm(in.)		Qty / box
		A	B	
2	<b>S02B-PASK-2</b>	2.0(.079)	6.0(.236)	1,000
3	<b>S03B-PASK-2</b>	4.0(.157)	8.0(.315)	1,000
4	<b>S04B-PASK-2</b>	6.0(.236)	10.0(.394)	500
5	<b>S05B-PASK-2</b>	8.0(.315)	12.0(.472)	500
6	<b>S06B-PASK-2</b>	10.0(.394)	14.0(.551)	500
7	<b>S07B-PASK-2</b>	12.0(.472)	16.0(.630)	250
8	<b>S08B-PASK-2</b>	14.0(.551)	18.0(.709)	250
9	<b>S09B-PASK-2</b>	16.0(.630)	20.0(.787)	250
10	<b>S10B-PASK-2</b>	18.0(.709)	22.0(.866)	250
11	<b>S11B-PASK-2</b>	20.0(.787)	24.0(.945)	250
12	<b>S12B-PASK-2</b>	22.0(.866)	26.0(1.024)	250
13	<b>S13B-PASK-2</b>	24.0(.945)	28.0(1.102)	250
14	<b>S14B-PASK-2</b>	26.0(1.024)	30.0(1.181)	200
15	<b>S15B-PASK-2</b>	28.0(1.102)	32.0(1.260)	200
16	<b>S16B-PASK-2</b>	30.0(1.181)	34.0(1.339)	200

### Material and Finish

Post: Copper alloy, copper-undercoated, tin/lead-plated

Wafer: Glass-filled PBT, UL94V-0, natural (white)

<For reference> As the color identification, the following alphabet shall be put in the underlined part. For availability, delivery and minimum order quantity, contact JST.

ex. **S03B-PASK-2**

S...natural (white)

K...black R...red E...blue M...green O...orange N...brown

P...purple PK...pink Y...yellow L...lemon yellow LE...light blue

H...gray TR...tomato red

# PA FAMILY SERIES / PA CONNECTOR (Crimp style Standard type)

## SMT type shrouded header

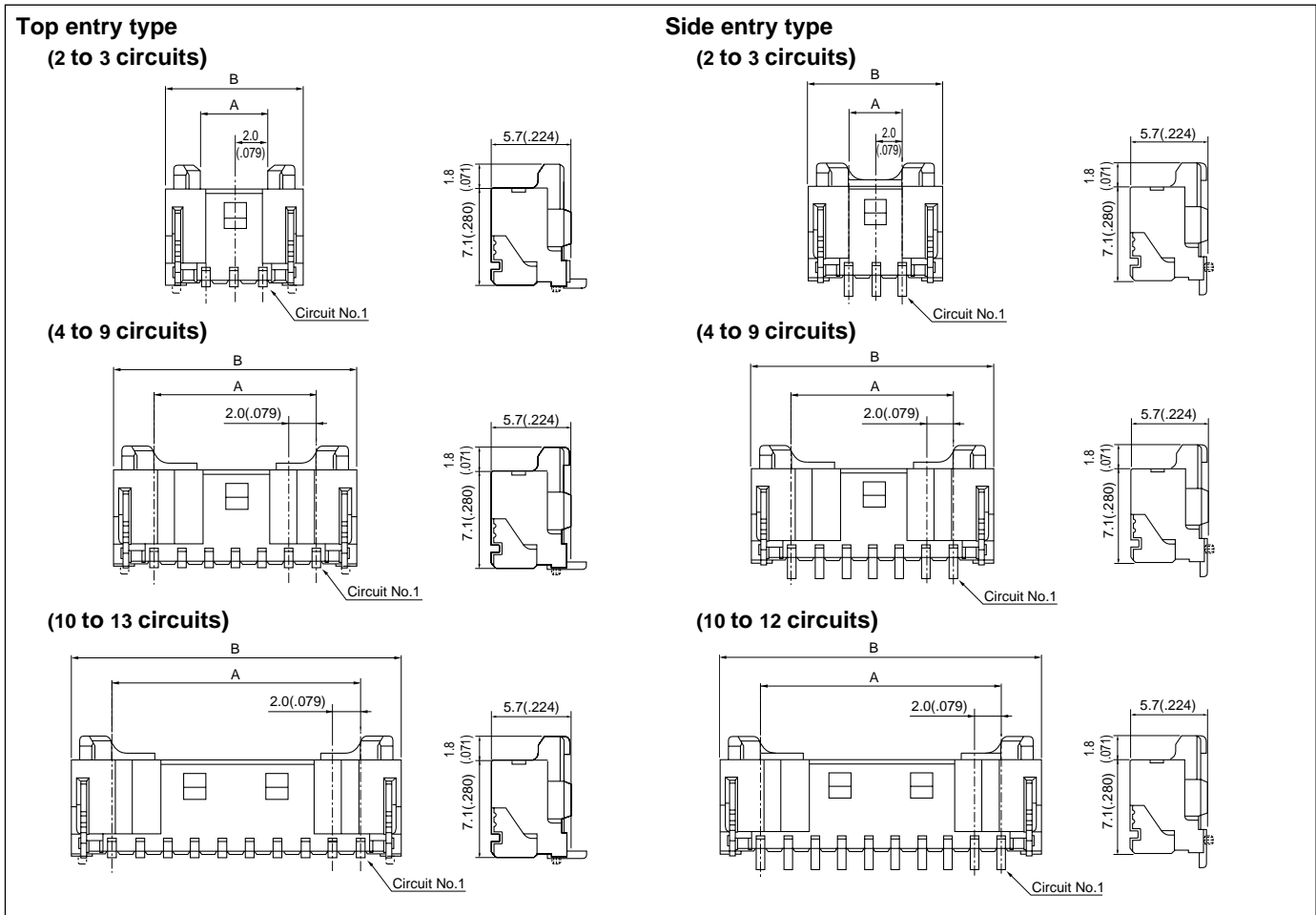

### Top entry type

Circuits	Model No.		Dimensions mm(in.)		Q'ty / reel
	Without a boss	With a boss	A	B	
2	BM02B-PASS-*	BM02B-PASS-1-*	2.0(.079)	8.0(.315)	500
3	BM03B-PASS-*	BM03B-PASS-1-*	4.0(.157)	10.0(.394)	500
4	BM04B-PASS-*	BM04B-PASS-1-*	6.0(.236)	12.0(.472)	500
5	BM05B-PASS-*	BM05B-PASS-1-*	8.0(.315)	14.0(.551)	500
6	BM06B-PASS-*	BM06B-PASS-1-*	10.0(.394)	16.0(.630)	500
7	BM07B-PASS-*	BM07B-PASS-1-*	12.0(.472)	18.0(.709)	500
8	BM08B-PASS-*	BM08B-PASS-1-*	14.0(.551)	20.0(.787)	500
9	BM09B-PASS-*	BM09B-PASS-1-*	16.0(.630)	22.0(.866)	500
10	BM10B-PASS-*	BM10B-PASS-1-*	18.0(.709)	24.0(.945)	500
11	BM11B-PASS-*	BM11B-PASS-1-*	20.0(.787)	26.0(1.024)	500
12	BM12B-PASS-*	BM12B-PASS-1-*	22.0(.866)	28.0(1.102)	500
13	BM13B-PASS-*	BM13B-PASS-1-*	24.0(.945)	30.0(1.181)	500

#### Material and Finish

Post: Brass, copper-undercoated, tin-plated  
 Wafer: Polyamide resin, UL94V-0, natural (ivory)  
 Solder tab: Brass, copper-undercoated, tin-plated

#### Note:

- (\*) : TF...taping product  
 TFT...taping product with suction tape.
- BM13B-PASS-\*(\*) and BM13B-PASS-1-\*(\*) are not UL/CSA approved.

### Side entry type

Circuits	Model No.		Dimensions mm(in.)		Q'ty / reel
	Without a boss	With a boss	A	B	
2	SM02B-PASS-*	SM02B-PASS-1-*	2.0(.079)	8.0(.315)	1,000
3	SM03B-PASS-*	SM03B-PASS-1-*	4.0(.157)	10.0(.394)	1,000
4	SM04B-PASS-*	SM04B-PASS-1-*	6.0(.236)	12.0(.472)	1,000
5	SM05B-PASS-*	SM05B-PASS-1-*	8.0(.315)	14.0(.551)	1,000
6	SM06B-PASS-*	SM06B-PASS-1-*	10.0(.394)	16.0(.630)	1,000
7	SM07B-PASS-*	SM07B-PASS-1-*	12.0(.472)	18.0(.709)	1,000
8	SM08B-PASS-*	SM08B-PASS-1-*	14.0(.551)	20.0(.787)	1,000
9	SM09B-PASS-*	SM09B-PASS-1-*	16.0(.630)	22.0(.866)	1,000
10	SM10B-PASS-*	SM10B-PASS-1-*	18.0(.709)	24.0(.945)	1,000
11	SM11B-PASS-*	SM11B-PASS-1-*	20.0(.787)	26.0(1.024)	1,000
12	SM12B-PASS-*	SM12B-PASS-1-*	22.0(.866)	28.0(1.102)	1,000

#### Material and Finish

Post: Brass, copper-undercoated, tin-plated  
 Wafer: Polyamide resin, UL94V-0, natural (ivory)  
 Solder tab: Brass, copper-undercoated, tin-plated

#### Note:

- (\*) : TB...taping product  
 TBT...taping product with suction tape.

# PA FAMILY SERIES /PA CONNECTOR (Crimp style Standard type)

## Taping specifications

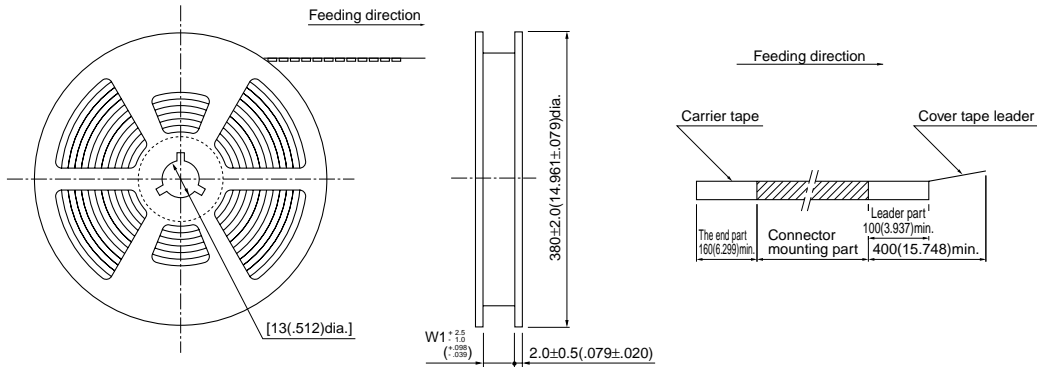

### Top entry type (2 to 5 circuits)

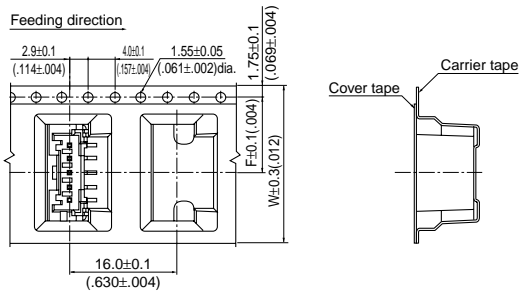

### (6 to 13 circuits)

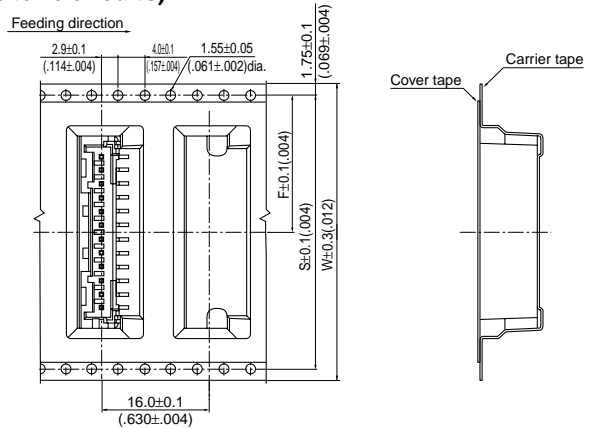

### Side entry type (2 to 5 circuits)

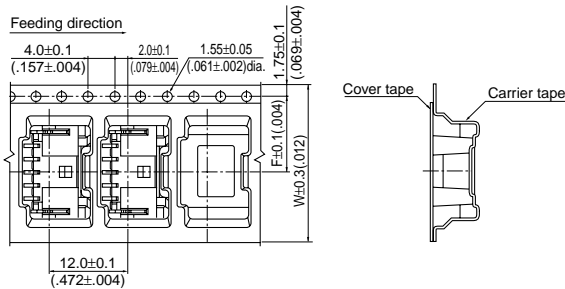

### (6 to 12 circuits)

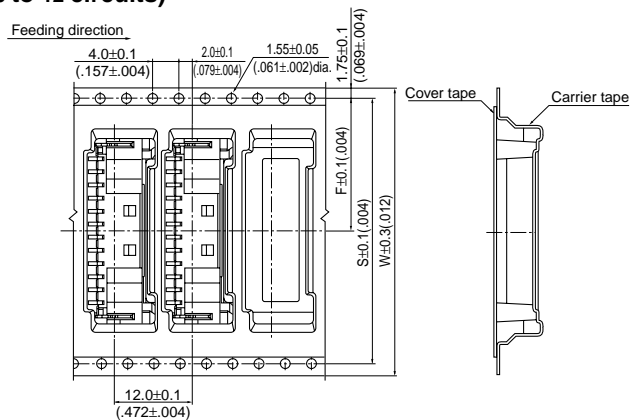

Circuits	Taping dimensions mm(in.)			Reel dimensions mm(in.)		Q'ty / reel	
	F	S	W	W <sub>1</sub>	Top entry type	Side entry type	
2 to 5	11.5(.453)	-	24.0(.945)	25.5(1.004)	500	1,000	
6, 7	14.2(.559)	28.4(1.118)	32.0(1.260)	33.5(1.319)	500	1,000	
8 to 13	20.2(.795)	40.4(1.591)	44.0(1.732)	45.5(1.791)	500	1,000	

#### Note:

- Specifications conform to JIS C 0806. The tape width, connector loading recess square hole dimensions, etc. are determined by the number of circuits and external shape of the connector to be loaded.
- Specifications are subject to change without prior notice.



# PA FAMILY SERIES / PA CONNECTOR (Crimp style Standard type)

## Shrouded header <High box type>

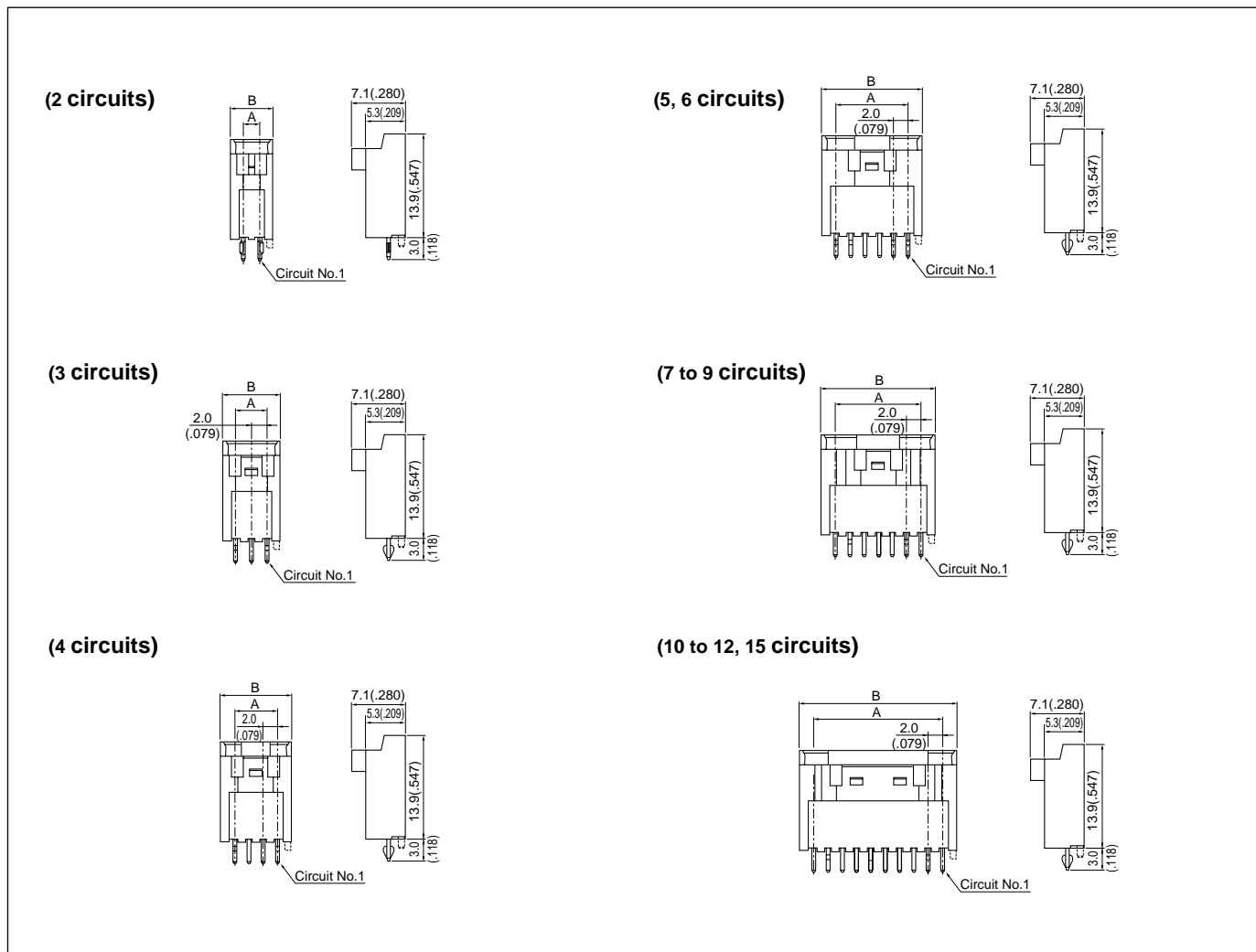

Circuits	Model No.		Dimensions mm(in.)		Qty / box
	Without a boss	With a boss	A	B	
2	BH02B-PASK	BH02B-PASK-1	2.0(.079)	6.0(.236)	900
3	BH03B-PASK	BH03B-PASK-1	4.0(.157)	8.0(.315)	675
4	BH04B-PASK	BH04B-PASK-1	6.0(.236)	10.0(.394)	550
5	BH05B-PASK	BH05B-PASK-1	8.0(.315)	12.0(.472)	450
6	BH06B-PASK	BH06B-PASK-1	10.0(.394)	14.0(.551)	375
7	BH07B-PASK	BH07B-PASK-1	12.0(.472)	16.0(.630)	325
8	BH08B-PASK	BH08B-PASK-1	14.0(.551)	18.0(.709)	300
9	BH09B-PASK	BH09B-PASK-1	16.0(.630)	20.0(.787)	275
10	BH10B-PASK	BH10B-PASK-1	18.0(.709)	22.0(.866)	250
11	BH11B-PASK	BH11B-PASK-1	20.0(.787)	24.0(.945)	225
12	BH12B-PASK	BH12B-PASK-1	22.0(.866)	26.0(1.024)	200
15	BH15B-PASK	BH15B-PASK-1	28.0(1.102)	32.0(1.260)	150

### Material and Finish

Post: Copper alloy, copper-undercoated, tin/lead-plated  
 Wafer: Glass-filled PBT, UL94V-0, natural (white)

# PA FAMILY SERIES /PA CONNECTOR (Crimp style Retainer mountable type)

## Contact

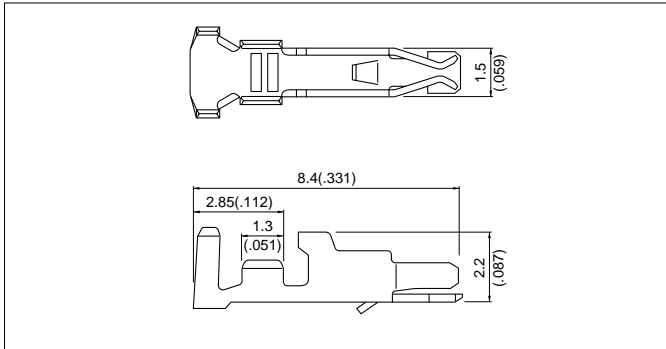

Model No.	Applicable wire			Q'ty / reel
	mm <sup>2</sup>	AWG #	Insulation O.D. mm(in.)	
<b>SPA-001T-P0.5</b>	0.13 to 0.33	26 to 22	0.9 to 1.5(.035 to .059)	10,000

### Material and Finish

Phosphor bronze, tin-plated

## Housing

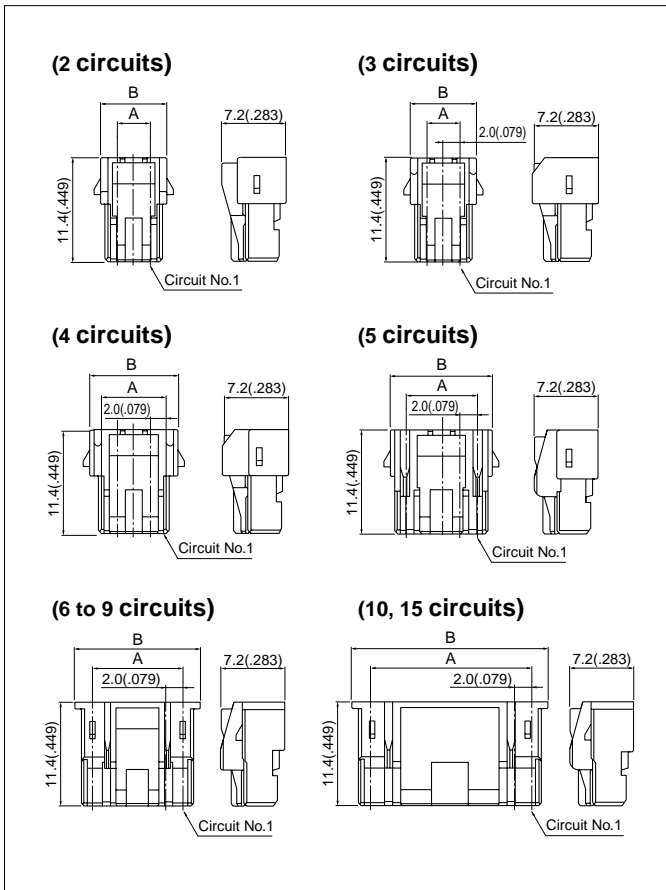

Circuits	Model No.	Dimensions mm(in.)		Q'ty / bag
		A	B	
2	<b>PARP-02V</b>	2.0(.079)	5.4(.213)	1,000
3	<b>PARP-03V</b>	4.0(.157)	7.4(.291)	1,000
4	<b>PARP-04V</b>	6.0(.236)	9.4(.370)	1,000
5	<b>PARP-05V</b>	8.0(.315)	11.4(.449)	1,000
6	<b>PARP-06V</b>	10.0(.394)	14.0(.551)	1,000
7	<b>PARP-07V</b>	12.0(.472)	16.0(.630)	1,000
8	<b>PARP-08V</b>	14.0(.551)	18.0(.709)	1,000
9	<b>PARP-09V</b>	16.0(.630)	20.0(.787)	1,000
10	<b>PARP-10V</b>	18.0(.709)	22.0(.866)	1,000
15	<b>PARP-15V</b>	28.0(1.102)	32.0(1.260)	500

### Material

Nylon 66, UL94V-0, natural (white)

Note: PARP-15V is not CSA approved.

<For reference> As the color identification, the following alphabet shall be put in the underlined part.

For availability, delivery and minimum order quantity, contact JST.

ex. **PARP-02V-oo**

(blank)...natural (white)

R...red E...blue Y...yellow M...green

# PA FAMILY SERIES /PA CONNECTOR (Crimp style Retainer mountable type)

## Retainer

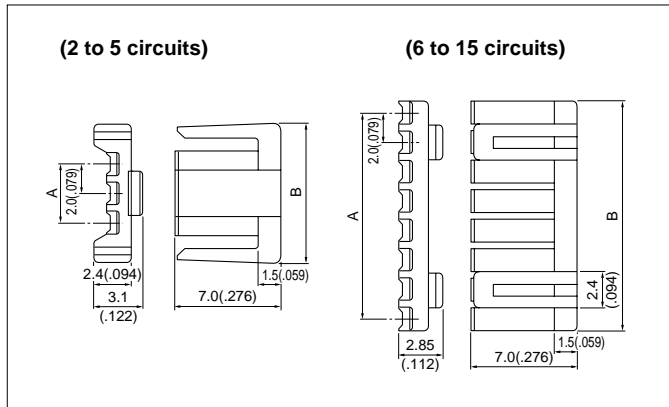

Circuits	Model No.	Dimensions mm(in.)		Q'ty / bag
		A	B	
2	<b>PMS-02V-S</b>	2.0( .079)	7.3( .287)	1,000
3	<b>PMS-03V-S</b>	4.0( .157)	9.3( .366)	1,000
4	<b>PMS-04V-S</b>	6.0( .236)	11.3( .445)	1,000
5	<b>PMS-05V-S</b>	8.0( .315)	13.3( .524)	1,000
6	<b>PMS-06V-S</b>	10.0( .394)	11.55( .455)	1,000
7	<b>PMS-07V-S</b>	12.0( .472)	13.55( .533)	1,000
8	<b>PMS-08V-S</b>	14.0( .551)	15.55( .612)	1,000
9	<b>PMS-09V-S</b>	16.0( .630)	17.55( .691)	1,000
10	<b>PMS-10V-S</b>	18.0( .709)	19.55( .770)	1,000
15	<b>PMS-15V-S</b>	28.0(1.102)	29.55(1.163)	1,000

### Material

Glass-filled nylon 66, UL94V-0, natural (ivory)

Note: PMS-09V-S, PMS-10V-S and PMS-15V-S are not CSA approved.

# PA FAMILY SERIES /PAF CONNECTOR (Insulation displacement type)

## Receptacle

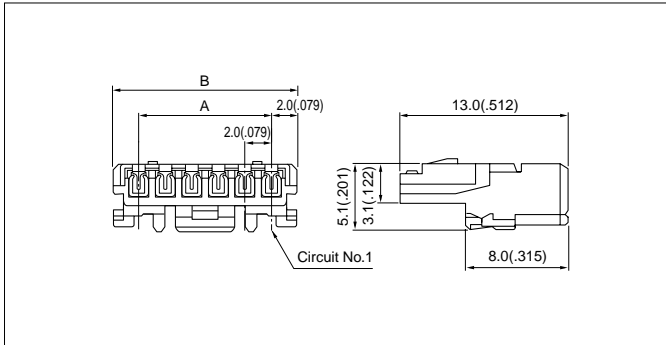

Circuits	Model No.	Dimensions mm(in.)		Q'ty / box
		A	B	
2	<b>02PAF-6S</b>	2.0( .079)	6.0( .236)	1,000
3	<b>03PAF-6S</b>	4.0( .157)	8.0( .315)	1,000
4	<b>04PAF-6S</b>	6.0( .236)	10.0( .394)	500
5	<b>05PAF-6S</b>	8.0( .315)	12.0( .472)	500
6	<b>06PAF-6S</b>	10.0( .394)	14.0( .551)	500
7	<b>07PAF-6S</b>	12.0( .472)	16.0( .630)	500
8	<b>08PAF-6S</b>	14.0( .551)	18.0( .709)	250
9	<b>09PAF-6S</b>	16.0( .630)	20.0( .787)	250
10	<b>10PAF-6S</b>	18.0( .709)	22.0( .866)	250
11	<b>11PAF-6S</b>	20.0( .787)	24.0( .945)	250
12	<b>12PAF-6S</b>	22.0( .866)	26.0(1.024)	250
13	<b>13PAF-6S</b>	24.0( .945)	28.0(1.102)	250
14	<b>14PAF-6S</b>	26.0(1.024)	30.0(1.181)	250
15	<b>15PAF-6S</b>	28.0(1.102)	32.0(1.260)	250

### Material and Finish

Contact: Phosphor bronze, tin-plated  
Housing: Nylon 66, UL94V-0, natural (white)

<For reference> As the color identification, the following alphabet shall be put in the underlined part. For availability, delivery and minimum order quantity, contact JST.

ex. **02PAF-6S**

S...natural (white)

R...red E...blue M...green Y...yellow

## Retainer

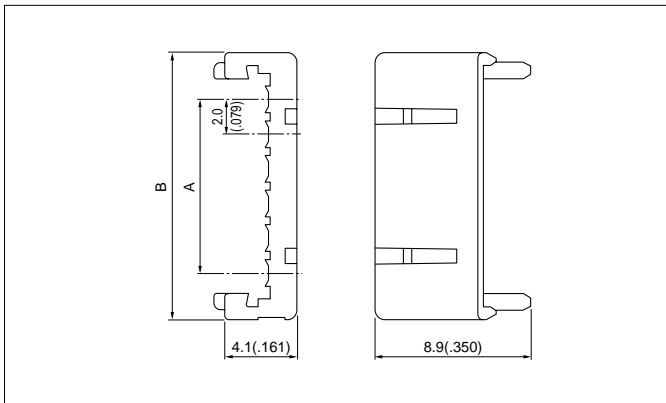

Circuits	Model No.	Dimensions mm(in.)		Q'ty / bag
		A	B	
2	<b>PAFS-02V-S</b>	2.0( .079)	7.4( .291)	1,000
3	<b>PAFS-03V-S</b>	4.0( .157)	9.4( .370)	1,000
4	<b>PAFS-04V-S</b>	6.0( .236)	11.4( .449)	1,000
5	<b>PAFS-05V-S</b>	8.0( .315)	13.4( .528)	1,000
6	<b>PAFS-06V-S</b>	10.0( .394)	15.4( .606)	1,000
7	<b>PAFS-07V-S</b>	12.0( .472)	17.4( .685)	1,000
8	<b>PAFS-08V-S</b>	14.0( .551)	19.4( .764)	1,000
9	<b>PAFS-09V-S</b>	16.0( .630)	21.4( .843)	1,000
10	<b>PAFS-10V-S</b>	18.0( .709)	23.4( .921)	1,000
11	<b>PAFS-11V-S</b>	20.0( .787)	25.4(1.000)	1,000
12	<b>PAFS-12V-S</b>	22.0( .866)	27.4(1.079)	1,000
13	<b>PAFS-13V-S</b>	24.0( .945)	29.4(1.157)	1,000
14	<b>PAFS-14V-S</b>	26.0(1.024)	31.4(1.236)	1,000
15	<b>PAFS-15V-S</b>	28.0(1.102)	33.4(1.315)	1,000

### Material

Glass-filled nylon 66, UL94V-0, natural (ivory)

Note: PAFS-09V-S, PAFS-10V-S, PAFS-11V-S, PAFS-12V-S, PAFS-13V-S, PAFS-14V-S and PAFS-15V-S are not UL/CSA approved.

# PA FAMILY SERIES /PAL CONNECTOR (Wire-to-wire type)

## Contact

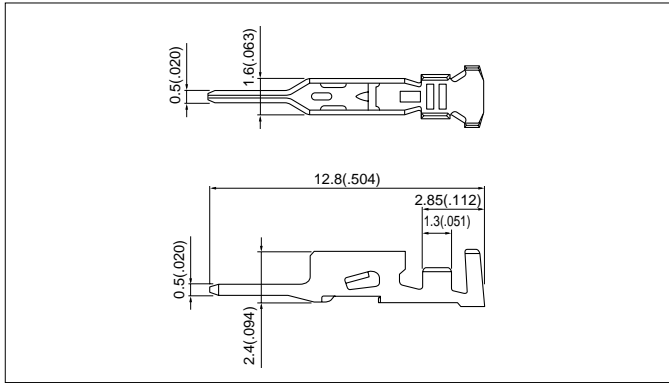

Model No.	Applicable wire			Q'ty / reel
	mm <sup>2</sup>	AWG #	Insulation O.D. mm(in.)	
<b>SPAL-001T-P0.5</b>	0.13 to 0.33	26 to 22	1.0 to 1.5(.039 to .059)	10,000
<b>SPAL-002T-P0.5</b>	0.08 to 0.21	28 to 24	0.9 to 1.5(.035 to .059)	

### Material and Finish

Phosphor bronze, tin-plated

## Housing

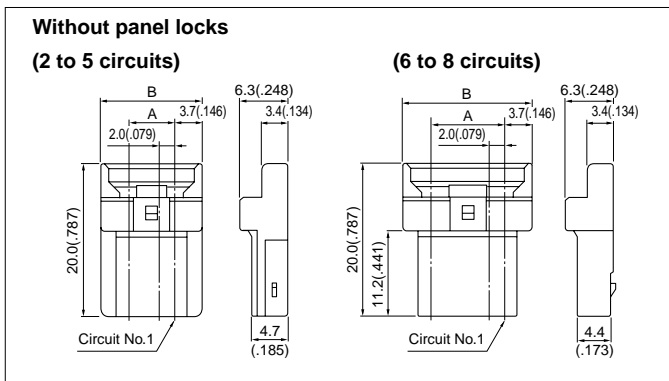

Circuits	Model No.	Dimensions mm(in.)		Q'ty / bag
		A	B	
2	<b>PALR-02VF</b>	2.0 (.079)	9.4 (.370)	1,000
3	<b>PALR-03VF</b>	4.0 (.157)	11.4 (.449)	1,000
4	<b>PALR-04VF</b>	6.0 (.236)	13.4 (.528)	1,000
5	<b>PALR-05VF</b>	8.0 (.315)	15.4 (.606)	1,000
6	<b>PALR-06VF</b>	10.0 (.394)	17.4 (.685)	1,000
7	<b>PALR-07VF</b>	12.0 (.472)	19.4 (.764)	1,000
8	<b>PALR-08VF</b>	14.0 (.551)	21.4 (.843)	1,000

### Material

Nylon 66, UL94V-0, natural (white)

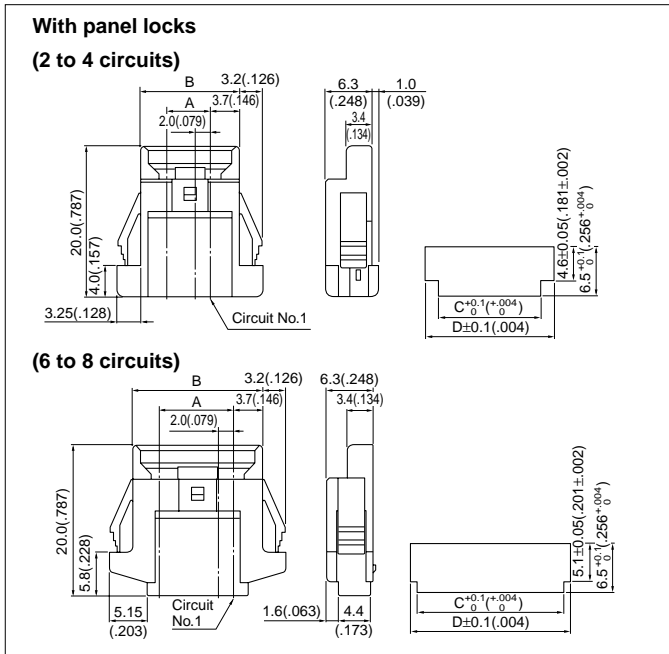

Circuits	Model No.	Dimensions mm(in.)				Q'ty / bag
		A	B	C	D	
2	<b>PALR-02V</b>	2.0(.079)	9.4(.370)	9.8(.386)	13.4(.528)	1,000
3	<b>PALR-03V</b>	4.0(.157)	11.4(.449)	11.8(.465)	15.4(.606)	1,000
4	<b>PALR-04V</b>	6.0(.236)	13.4(.528)	13.8(.543)	17.4(.685)	1,000
6	<b>PALR-06V</b>	10.0(.394)	17.4(.685)	19.8(.780)	21.4(.843)	1,000
7	<b>PALR-07V</b>	12.0(.472)	19.4(.764)	21.8(.858)	23.4(.921)	1,000
8	<b>PALR-08V</b>	14.0(.551)	21.4(.843)	23.8(.937)	25.4(1.000)	1,000

### Material

Nylon 66, UL94V-0, natural (white)

<For reference> As the color identification, the following alphabet shall be put in the underlined part. For availability, delivery and minimum order quantity, contact JST.

ex. **PALR-02V(F)-oo**  
 (blank)...natural (white)  
 R...red E...blue M...green Y...yellow

## Retainer

Retainers are interchangeable with those of the PA crimp style retainer mountable type.

# PA FAMILY SERIES /PA•PAF•PAL CONNECTOR

## PC board layout (viewed from component side) and Assembly layout

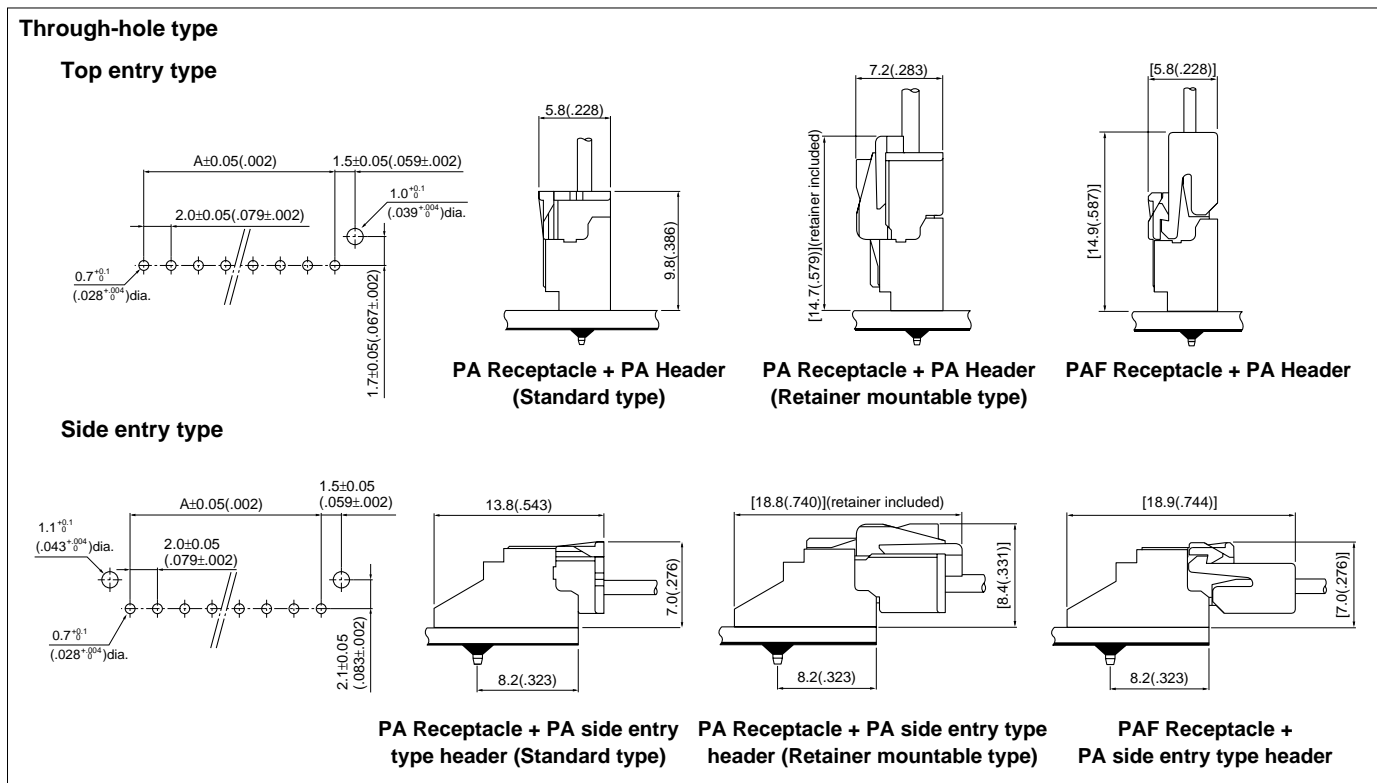

**Note:**  
 1. Tolerances are non-cumulative:  $\pm 0.05\text{mm}$  ( $\pm 0.002''$ ) for all centers.  
 2. Hole dimensions differ according to the kind of PC board and piercing method.  
 The dimensions above should serve as a guideline. Contact JST for details.

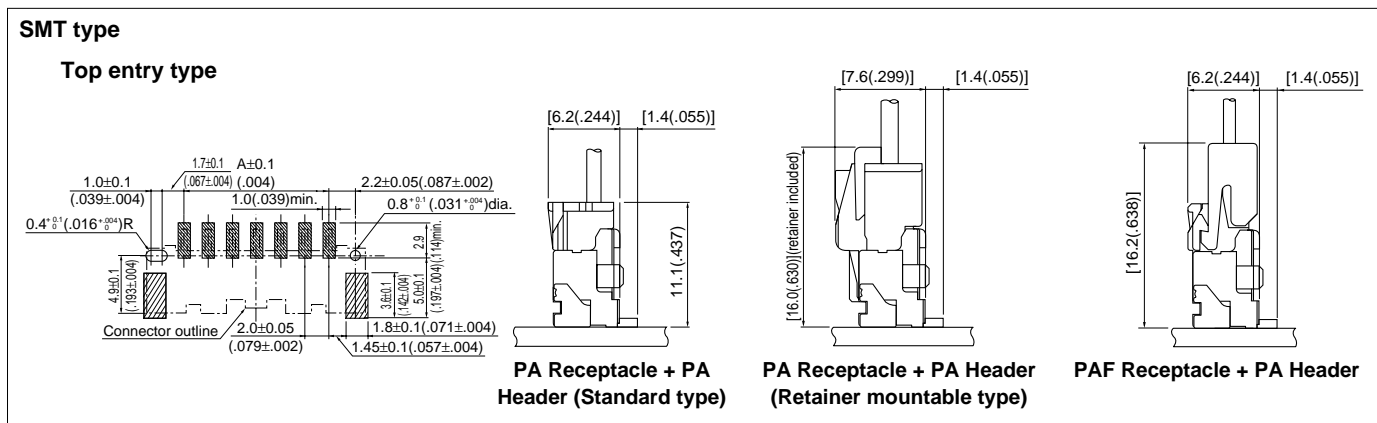

**Note:**  
 1. Tolerances are non-cumulative:  $\pm 0.05\text{mm}$  ( $\pm 0.002''$ ) for all centers.  
 2. The dimensions above should serve as a guideline. Contact JST for details.

# PA FAMILY SERIES /PA•PAF•PAL CONNECTOR

## PC board layout (viewed from component side) and Assembly layout

### SMT type

#### Side entry type

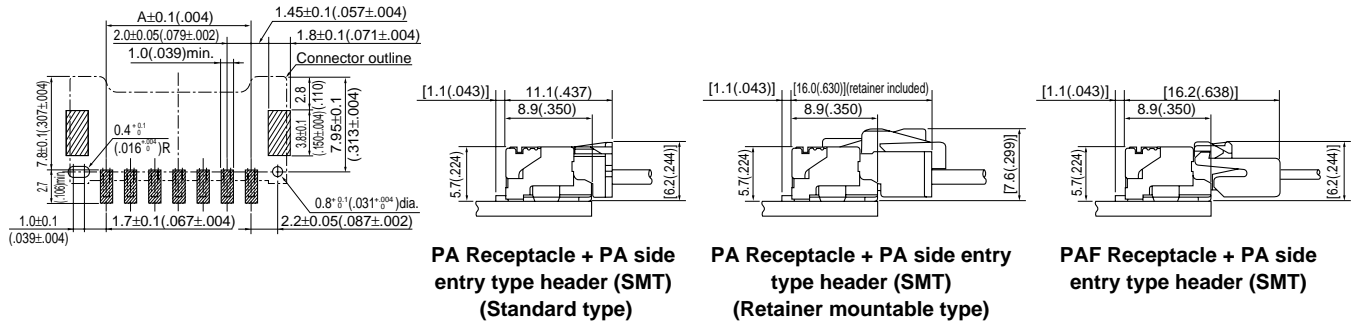

### High box type

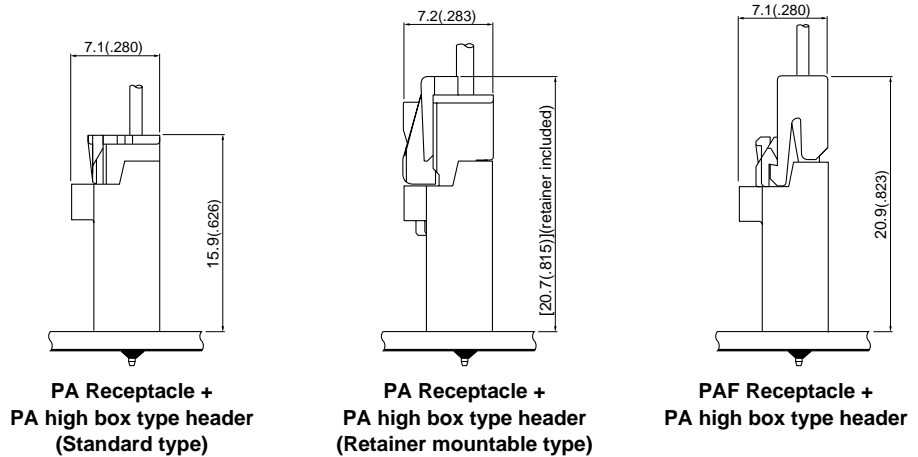
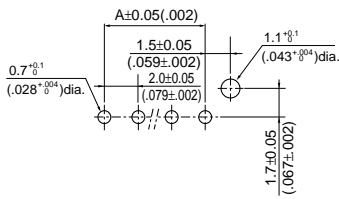

**Note:**

1. Tolerances are non-cumulative:  $\pm 0.05\text{mm}$  ( $\pm .002''$ ) for all centers.
2. Hole dimensions differ according to the kind of PC board and piercing method.  
The dimensions above should serve as a guideline. Contact JST for details.

## Assembly layout

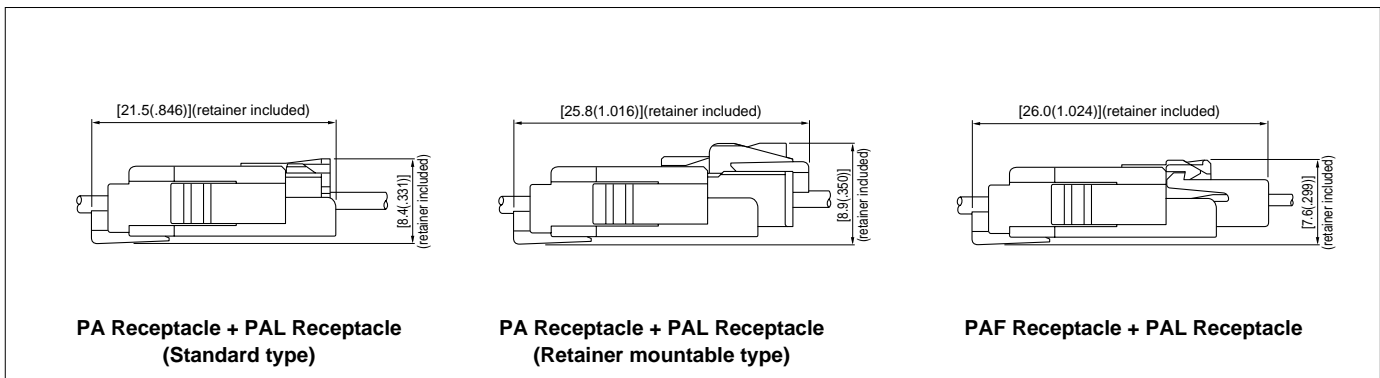

# PA FAMILY SERIES /PA•PAF•PAL CONNECTOR

## Applicator for the semi-automatic press AP-K2N

Contact	Crimp applicator MKS-L(-10)		Compact crimp applicator MKS-LS-10		Strip-crimp applicator MKS-SC-10
	with safety cover	without safety cover	with safety cover	without safety cover	with safety cover
<b>SPHD-001T-P0.5</b>	APLMK SPHD001-05	APLNC SPHD001-05	APLMKLS SPHD001-05	APLLSNC SPHD001-05	APLSC SPHD001-05
<b>SPHD-002T-P0.5</b>	APLMK SPHD002-05	APLNC SPHD002-05	APLMKLS SPHD002-05	APLLSNC SPHD002-05	APLSC SPHD002-05
<b>SPA-001T-P0.5</b>	APLMK SPA001-05	APLNC SPA001-05	–	–	–
<b>SPAL-001T-P0.5</b>	APLMK SPAL001-05	APLNC SPAL001-05	–	–	–
<b>SPAL-002T-P0.5</b>	APLMK SPAL002-05	APLNC SPAL002-05	–	–	–