

阅读申明

- 1.本站收集的数据手册和产品资料都来自互联网，版权归原作者所有。如读者和版权方有任何异议请及时告之，我们将妥善解决。
- 2.本站提供的中文数据手册是英文数据手册的中文翻译，其目的是协助用户阅读，该译文无法自动跟随原稿更新，同时也可能存在翻译上的不当。建议读者以英文原稿为参考以便获得更精准的信息。
- 3.本站提供的产品资料，来自厂商的技术支持或者使用者的心得体会等，其内容可能存在描述上的差异，建议读者做出适当判断。
- 4.如需与我们联系，请发邮件到marketing@iczoom.com，主题请标有“数据手册”字样。

Read Statement

1. The datasheets and other product information on the site are all from network reference or other public materials, and the copyright belongs to the original author and original published source. If readers and copyright owners have any objections, please contact us and we will deal with it in a timely manner.
2. The Chinese datasheets provided on the website is a Chinese translation of the English datasheets. Its purpose is for reader's learning exchange only and do not involve commercial purposes. The translation cannot be automatically updated with the original manuscript, and there may also be improper translations. Readers are advised to use the English manuscript as a reference for more accurate information.
3. All product information provided on the website refer to solutions from manufacturers' technical support or users the contents may have differences in description, and readers are advised to take the original article as the standard.
4. If you have any questions, please contact us at marketing@iczoom.com and mark the subject with "Datasheets" .

VEAM

VRPC Rectangular Plastic Connector

Innovative, flexible, light and small

Features & Benefits



ITT

ENGINEERED FOR LIFE

VEAM Rectangular Plastic Connector – innovative, flexible, light and small

With the ever increasing electronic content requirements of modern systems in Mass Transit, Off Road and Industrial equipment VEAM's innovative design team has produced a new connector range to meet the needs of the 21st Century.

By choosing the VRPC range you can be assured that you are working with a partner who has over 90 years of experience of connector design and manufacturing excellence. These flexible, plastic connectors are 80% lighter and 30% smaller. The connector is qualified for the industry compliant NFF 16-101 & NFF 16-102 ratings for both fire and smoke resistance.

The VRPC range has been designed to meet your needs. Whether flame retardant, sealing, weight reduction, flexible contact system, polarization and cable support are high on your list of requirements, you will find all these features within the range.

Based on our successful innovations for the mass transit, off road and industrial markets, VEAM is pushing the boundaries of technology to ensure that our customers can meet their requirements for the 21st Century.



Our parts do, what we say they will do.

Why customers benefit from choosing VEAM's VRPC Series

- Proven contact system
- Industry compliant fire and smoke resistant
- Space saving
- Sealing flexibility
- Field polarization
- Weight reduction
- Mounting flexibility

Applications

- Railway
 - Wipers, - Shutters, - LCD Displays, - Doors
 - Fire Control Units, - Air Conditioning, - Signaling
 - Information Systems and Seats
- Off Road
 - Cabling, - Lighting
- Industrial
 - Lighting systems, - Motorway information systems,
 - Traffic management systems, - Security systems,
 - Printing machines, - Factory robotics, - Controllers,
 - Automatic doors, - Agricultural and pumping equipment



Innovative grommet system

The innovative grommet system means that no filler plugs are required. Machined contacts are recommended when using the grommet system.

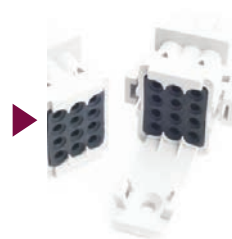

Flexible cable support

The flexible cable support not only allows for support of the cable but is also used as a fixing device to the panel.



Snap in system

Snap in system mechanism with an audible mating connection.



Machined and stamped contacts

Machined, stamped or pcb contacts that support a wide range of wires from 0,25 to 2,5 mm².

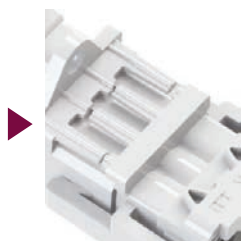

Polarization

During the assembly process it is possible to set the polarization by cutting the same keys on both the plug and panel connector side.



Withstand

All contacts in a fully populated connector can withstand 15 amps at the same time.

Delivering a durable, reliable and innovative product for rail industrial and off road equipment

Ordering information

VRPC- 03 P- 67

Connector layout:
3, 6, 12 contacts

Contact type
S= Female for plug connector
P= Male for panel connector

Sealing level
20= Not sealed
67= Sealed IP67

Contact Arrangement

Layouts
3 Way

6 Way

12 Way



3 Way order code

Conn. P/N	Spare parts P/N	
VRPC-03P-67	VRPC-BODY-03P-67 (*)	
	VRPC-GROMMET-03	
	VRPC-CLIP	

Conn. P/N	Spare parts P/N	
VRPC-03S-67	VRPC-03S-20	
	VRPC-GROMMET-03	
	VRPC-CLIP	

6 Way order code

Conn. P/N	Spare parts P/N	
VRPC-06P-67	VRPC-BODY-06P-67 (*)	
	VRPC-GROMMET-06	
	VRPC-CLIP	

Conn. P/N	Spare parts P/N	
VRPC-06S-67	VRPC-06S-20	
	VRPC-GROMMET-06	
	VRPC-CLIP	

12 Way order code

Conn. P/N	Spare parts P/N	
VRPC-12P-67	VRPC-BODY-12P-67 (*)	
	VRPC-GROMMET-12	
	VRPC-CLIP	

Conn. P/N	Spare parts P/N	
VRPC-12S-67	VRPC-12S-20	
	VRPC-GROMMET-12	
	VRPC-CLIP	

Accessories order code

VRPC-CABLE SUPPORT		VRPC-CABLE SUPPORT
--------------------	--	--------------------

VEAM Rectangular Plastic Connector – Multiple configurations for multiple applications

Dimensions

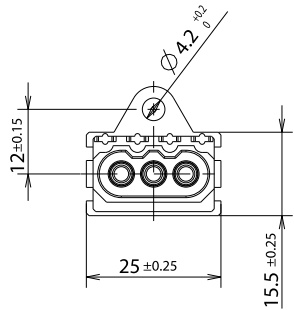

Receptacle, 3 poles

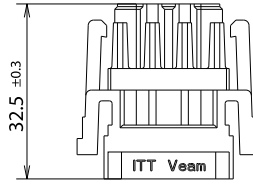
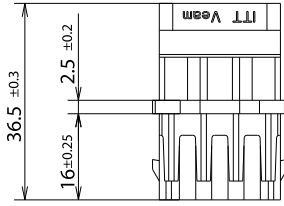

Plug, 3 poles

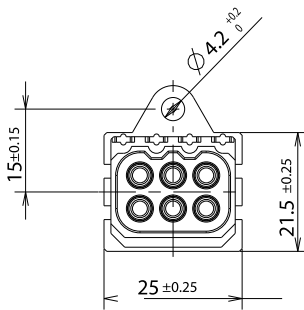
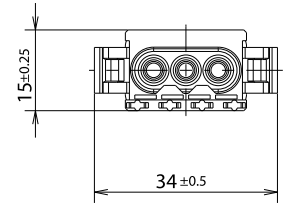

Receptacle, 6 poles

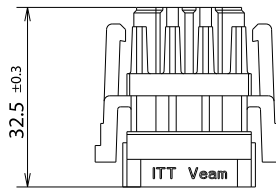
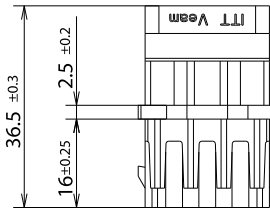

Plug, 6 poles

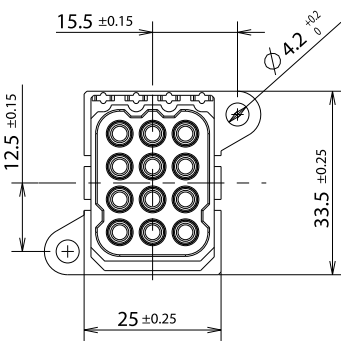
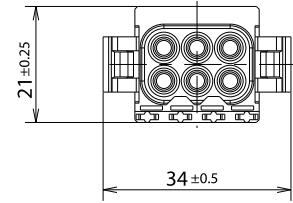

Receptacle, 12 poles

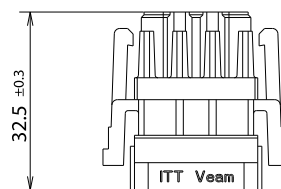
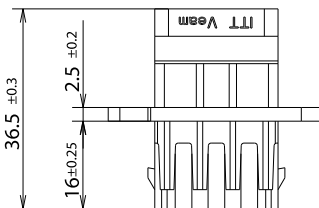

Plug, 12 poles

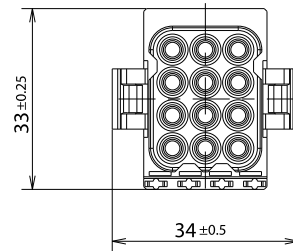

Cable Support

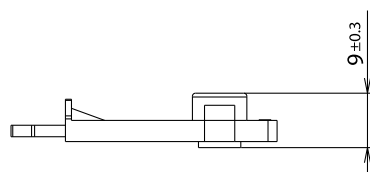
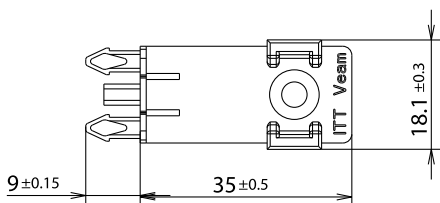

Grommet Retention Clip

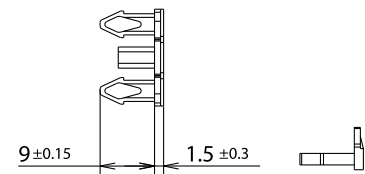

Delivering reliable and innovative products for rail industrial and off road equipment

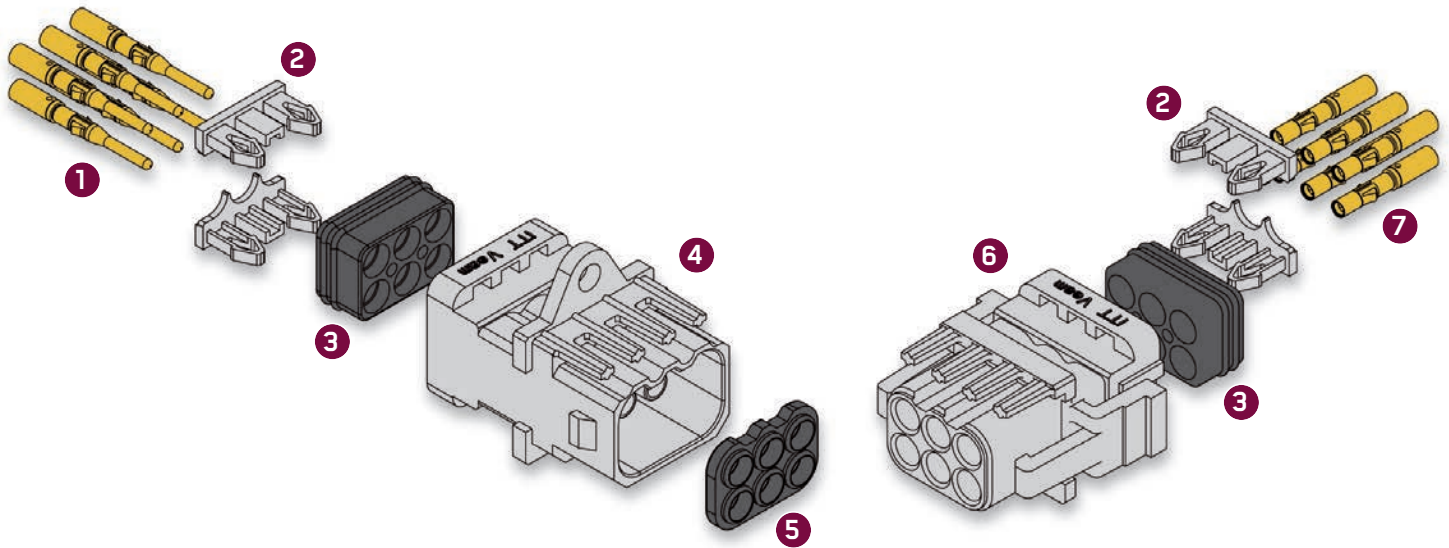

- | | | | |
|----------------------------|-------------------------|------------------------|--------------------|
| 1. Male Contacts | 3. Grommet | 5. Front Gasket | 7. Female Contacts |
| 2. Grommet Retention Clips | 4. Panel Connector Body | 6. Plug Connector Body | |

VRPC Key Product Data Ratings according to NFF61030

ELECTRICAL			
Working voltage	380Vac/500Vdc	Contacts size	Ø1,5mm (size 16)
Creepage distance	12mm min.	Rated current of a pair of contacts	15A
Clearance distance	8mm min.	Contacts resistance	2,5 mOhms max.
Withstand voltage	3250 Vac	Insulation resistance	5000 MOhms min.
Cable Range	from 0,25 up to 2,5mm ²		
MECHANICAL			
Contact retention force	70N	Shock & vibration	EN 61373 Cat. 1 Class A
Mating cycles	500 min.	Polarisation	6
ENVIRONMENTAL			
Temperature range	-40 + 100°C	Salt spray	96 hrs
IP rating (mated)	IP67 EN 60529	Fluid resistance	NF F 61-030
Fire & smoke	Rated I2F2 (NF F 16-101 & NF F 16-102)	Sealing (cable Diameter)	Ø1,15mm – Ø3,8mm
MATERIAL			
Bodies	Thermoplastic	Contacts	Copper alloy, gold plated
Gasket and grommet	Silicone rubber		
WEIGHTS			
	3 way	6 way	12 way
VRPC-xxP-67	7,1g	10,25g	16g
VRPC-xxS-67	7,0g	10,1g	16g
Cable support		1,7g	
CONTACTS WEIGHT			
	Pin	Socket	
Machined	0,7g	0,45g	

VEAM Rectangular Plastic Connector – innovative, flexible, light and small

Mounting options



Weight

Connector type	3 Contacts	6 Contacts	12 Contacts
Receptacle -20	5.8 gr.	8.1 gr.	12.0 gr.
Plug -20	5.3 gr.	8.5 gr.	13.8 gr.
Receptacle -67	7.3 gr.	10.6 gr.	16.2 gr.
Plug -67	6.6 gr.	10.5 gr.	17.2 gr.
Cable support		1.1 gr.	

Contacts are not included.

Panel cut out

Layout	A	B	C	ØD	Fig.
3 ways	15	23	12	4.2 / M4	1
6 ways	21	23	15	4.2 / M4	1
12 ways	33	23	-	4.2 / M4	2

Dashed geometries and dimensions are necessary only for rear panel mounting
Panel thickness from 1.5 up to 3mm

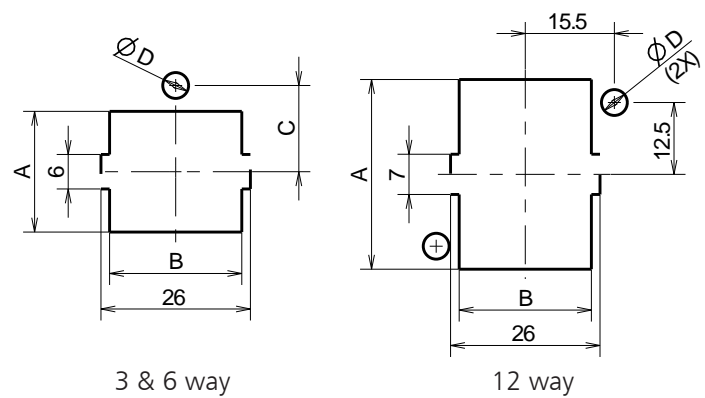

Polarization

The integrated pins on the connector housing provide different mating polarizations to prevent cross mating.

During the assembly process you can customize the polarization by cutting the appropriate pins on both the plug and panel connector. The cutting operation can be performed using scissors or a blade.

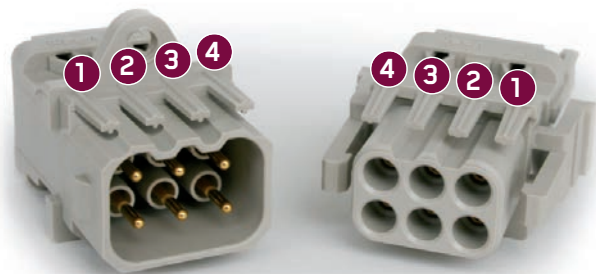

RECEPTACLE	Polarisation	A				Polarisation	B				Polarisation	C			
	Pin Number	1	2	3	4	Pin Number	1	2	3	4	Pin Number	1	2	3	4
	Cut / Uncut					Cut / Uncut					Cut / Uncut				

PLUG	Cut / Uncut			●	●	Cut / Uncut	●	●			Cut / Uncut		●	●	
	Pin Number	1	2	3	4	Pin Number	1	2	3	4	Pin Number	1	2	3	4
	Polarisation	A				B				C					

RECEPTACLE	Polarisation	D				Polarisation	E				Polarisation	F			
	Pin Number	1	2	3	4	Pin Number	1	2	3	4	Pin Number	1	2	3	4
	Cut / Uncut					Cut / Uncut					Cut / Uncut				

PLUG	Cut / Uncut	●			●	Cut / Uncut		●		●	Cut / Uncut	●			●
	Pin Number	1	2	3	4	Pin Number	1	2	3	4	Pin Number	1	2	3	4
	Polarisation	D				E				F					

● removed (cutted) pins

Delivering reliable and innovative products for rail industrial and off road equipment

Contact data ratings

	T2P <ul style="list-style-type: none"> • Two piece formed (stamped) contact • For up to 200 mating cycles • Full support tooling available 		T3P <ul style="list-style-type: none"> • Three piece machined contact • For up to 500 mating cycles • Full support tooling available 		
Contact Type	Standard Crimp 	High Conductivity Crimp 	Machined Crimp 	Solder Cup 	Flow Solder (PCB) 
TECHNICAL AND PERFORMANCE DATA					
Supported wire sizes	AWG 14 to 26	AWG 14 to 26	AWG 14 to 26	AWG 14 to 26	-
Current rating	13 A	16 A	15 A	13 A	Up to 30 A
Mechanical endurance	Up to 200 insertions	Up to 200 insertions	Up to 500 insertions	Up to 500 insertions	Up to 500 insertions
Body material	Brass	Copper Alloy	Brass	Brass	Brass
Retention spring material	Stainless Steel	Stainless Steel	Beryllium Copper	Beryllium Copper	Beryllium Copper
PLATING AVAILABILITY					
Tin	Yes	Yes	Yes	Yes	Yes
Gold	0,75 μm	0,75 μm	0,4 μm (pin) 0,75 μm (socket)	0,4 μm (pin) 0,75 μm (socket)	0,4 μm (pin) 0,75 μm (socket)
CONNECTOR/CONTACT CAPABILITY					
VRPC Snap Together Rectangular, Slimline (TST) and Flame Retardant (TFR)	Yes	Yes	Yes	Yes	Yes pre-installed in connectors
Multiway (TM)	Yes	Yes	Yes	Yes	Yes
Ringlock (TR)	Yes	Yes	Yes	Yes	Yes
Neptune (TN)	Yes	Yes	Yes	Yes	Yes
Neptune Metal (TNM)	Yes	Yes	Yes	Yes	-
High Voltage (THV)	-	-	-	-	-

VEAM Rectangular Plastic Connector – Stamped Contact Information

Formed (Stamped) Crimp Contacts – Standard Brass Material

- 13 A current rating.
- Three plating styles available.
- Separate retention spring.
- Up to 200 mating cycles.
- Wide range of wire sizes.
- Full support tooling available.
- Two part design.



Size 14 to 16 AWG,
No Insulation Grip

Size 16 to 26 AWG,
Insulation Grip

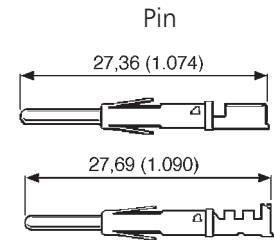
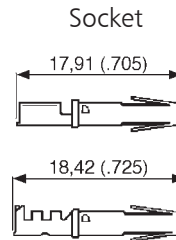

			PART NUMBER PACK (100)			PART NUMBER REELED (3000)				
Wire Range mm ²	Wire Size	Contact	Tin Plating	Gold Flash	1mm (40 μ in.) Gold Plating	Tin Plating	Gold Flash	1 mm (40 μ in.) Gold Plating	Insulation Diameter	Strip Length
0,14 - 0,25	26-24 AWG	Pin	192990-0020	192990-0080	192900-0448	192990-2510	192990-2650	192900-0406	0,89 (.035) - 1,58 (.062)	3,95 (.155)±0,25(.009)
0,14 - 0,25	26-24 AWG	Socket	192990-0030	192990-0090	192900-0452	192990-2550	192990-2690	192900-0410	0,89 (.035) - 1,58 (.062)	3,95 (.155)±0,25(.009)
0,32 - 0,50	22-20 AWG	Pin	192990-0040	192922-1460	192900-0447	192990-2500	192990-2640	192900-0405	1,17 (.046) - 2,08 (.081)	3,95 (.155)±0,25(.009)
0,32 - 0,50	22-20 AWG	Socket	192990-0050	192922-1470	192900-0451	192990-2540	192990-2680	192900-0409	1,17 (.046) - 2,08 (.081)	3,95 (.155)±0,25(.009)
0,75 - 1,50	18-16 AWG	Pin	192990-0060	192990-0100	192900-0446	192990-2490	192990-2630	192900-0404	2,00 (.078) - 2,70 (.106)	3,95 (.155)±0,25(.009)
0,75 - 1,50	18-16 AWG	Socket	192990-0070	192990-0110	192900-0450	192990-2530	192990-2670	192900-0408	2,00 (.078) - 2,70 (.106)	3,95 (.155)±0,25(.009)
1,50 - 2,50	16-14 AWG	Pin	192990-1240	192990-1220	192900-0445	192990-2480	192990-2620	192900-0403	Without insulation support	5,60 (.220)±0,25(.009)
1,50 - 2,50	16-14 AWG	Socket	192990-1250	192990-1230	192900-0449	192990-2520	192990-2660	192900-0407	Without insulation support	5,60 (.220)±0,25(.009)

Formed (Stamped) Crimp Contacts – High Conductivity Material

- 16 A current rating.
- Recommended for elevated temperatures.
- High conductivity copper alloy with tin plating.
- For use with standard crimp tooling.
- Two part design.
- Up to 200 mating cycles.



Size 14 to 16 AWG,
No Insulation Grip

Size 16 to 26 AWG,
Insulation Grip

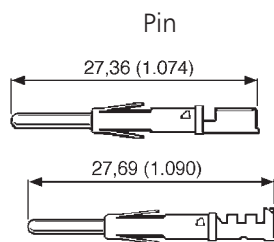
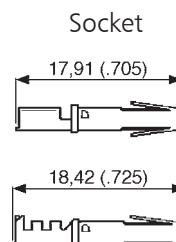

			PART NUMBER PACK (100)	PART NUMBER REELED (3000)		
Wire Range mm ²	Wire Size	Contact	Tin Plating	Tin Plating	Insulation Diameter	Strip Length
0,14 - 0,25	26-24 AWG	Pin	192900-0122	192900-0120	0,89 (.035) - 1,58 (.062)	3,95 (.155)±0,25 (.009)
0,14 - 0,25	26-24 AWG	Socket	192900-0123	192900-0121	0,89 (.035) - 1,58 (.062)	3,95 (.155)±0,25 (.009)
0,32 - 0,50	22-20 AWG	Pin	192900-0126	192900-0124	1,17 (.046) - 2,08 (.081)	3,95 (.155)±0,25 (.009)
0,32 - 0,50	22-20 AWG	Socket	192900-0127	192900-0125	1,17 (.046) - 2,08 (.081)	3,95 (.155)±0,25 (.009)
0,75 - 1,50	18-16 AWG	Pin	192900-0002	192900-0000	2,00 (.078) - 2,70 (.106)	3,95 (.155)±0,25 (.009)
0,75 - 1,50	18-16 AWG	Socket	192900-0003	192900-0001	2,00 (.078) - 2,70 (.106)	3,95 (.155)±0,25 (.009)
1,50 - 2,50	16-14 AWG	Pin	192900-0005	192900-0004	Without insulation support	5,60 (.220)±0,25 (.009)
1,50 - 2,50	16-14 AWG	Socket	192900-0007	192900-0006	Without insulation support	5,60 (.220)±0,25 (.009)

VEAM Rectangular Plastic Connector – Machined Contact Information

Machined Crimp Contacts

- 15 A current rating.
- Separate contact and retention spring.
- Up to 500 mating cycles.
- Variety of plating options.
- Full support tooling available.



Size 16 AWG,
No Insulation Grip

Size 20 to 26 AWG,
Insulation Grip

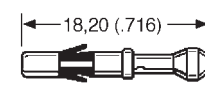
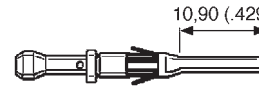
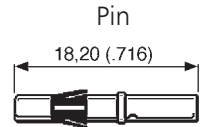
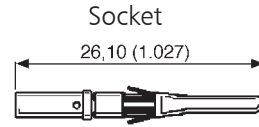

			PART NUMBER PACK (100)					
Wire Range mm ²	Wire Size	Contact	Gold Plating(X)	Gold Plating(Y)	Tin Plating	Insulation Diameter	Strip Length	Color Band
0,08 - 0,23	26 AWG	Pin	192991-0101	192991-0100	192991-0102	0,90 (.035) - 1,40 (.055)	5,08 (.200)±0,25 (.009)	Black
0,08 - 0,23	26 AWG	Socket	192991-0054	192991-0042	192991-0048	0,90 (.035) - 1,40 (.055)	5,08 (.200)±0,25 (.009)	Black
0,20 - 0,24	24 AWG	Pin	192991-0093	192991-0092	192991-0094	1,05 (.041) - 1,60 (.062)	5,08 (.200)±0,25 (.009)	Blue
0,20 - 0,24	24 AWG	Socket	192991-0055	192991-0043	192991-0049	1,05 (.041) - 1,60 (.062)	5,08 (.200)±0,25 (.009)	Blue
0,25 - 0,50	22 AWG	Pin	192991-0097	192991-0096	192991-0098	1,60 (.062) - 2,15 (.084)	5,08 (.200)±0,25 (.009)	Red
0,25 - 0,50	22 AWG	Socket	192991-0056	192991-0044	192991-0050	1,60 (.062) - 2,15 (.084)	5,08 (.200)±0,25 (.009)	Red
0,44 - 0,64	20 AWG	Pin	192991-0089	192991-0088	192991-0090	1,60 (.062) - 2,10 (.082)	5,08 (.200)±0,25 (.009)	Green
0,44 - 0,64	20 AWG	Socket	192991-0058	192991-0046	192991-0052	1,60 (.062) - 2,10 (.082)	5,08 (.200)±0,25 (.009)	Green
0,60 - 1,51	16 AWG	Pin	192991-0085	192991-0084	192991-0086	Without insulation support	7,11 (.279)±0,25 (.009)	Black
0,60 - 1,51	16 AWG	Socket	192991-0059	192991-0047	192991-0053	Without insulation support	7,11 (.279)±0,25 (.009)	Black
0,60 - 1,51	16 AWG	Pin	192991-0085	192991-0084	192991-0086	Without insulation support	7,11 (.279)±0,25 (.009)	Black
0,60 - 1,51	16 AWG	Socket	192991-0059	192991-0047	192991-0053	Without insulation support	7,11 (.279)±0,25 (.009)	Black
2.50	14 AWG	Pin	121587-0021	-	-	No insulation support	7,11 (.279)±0,25 (.009)	-
2.50	14 AWG	Socket	121587-0039	-	-	No insulation support	7,11 (.279)±0,25 (.009)	-

(Y) Gold plating Pin: 0,4 μm (16 μin.). Gold plating Socket: 0,75 μm (30 μin.). (X) Gold plating Pin & Socket: 3 μm (120 μin.).

Dimensions shown in mm (inch). Specifications and dimensions subject to change.

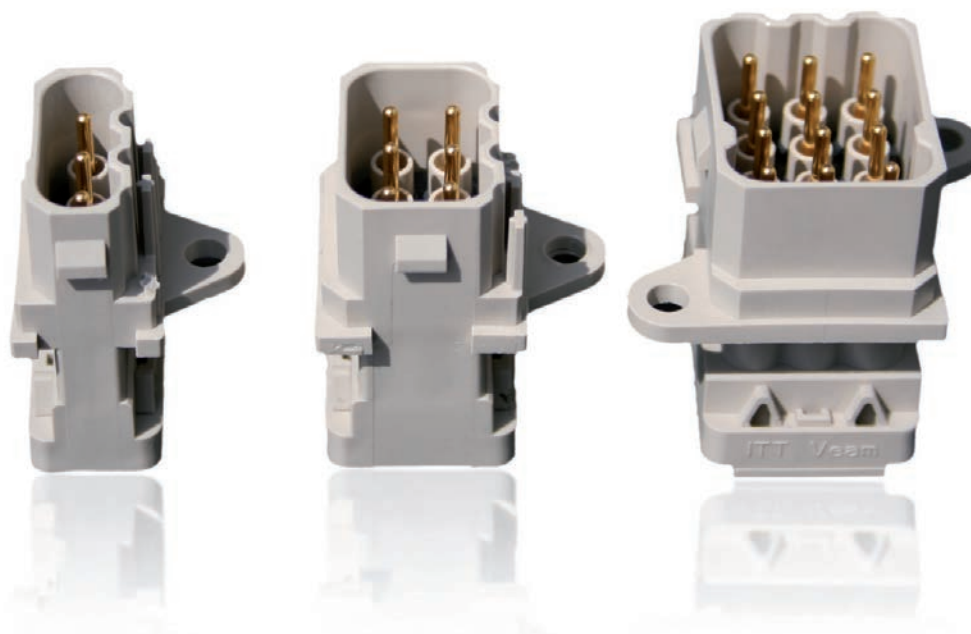

VEAM Rectangular Plastic Connector – Application Tooling Information

Hand Tools for Formed (Stamped) contacts



Ratcheted Hand Tool

A range of single action, factory calibrated tools are available to support the stamped contacts and 30 A power contacts.

Signal Contact	Power Contact	Part Number
14-16 AWG	N/A	121586-5238
16-18 AWG	N/A	121586-5237
20-22, 24-26 AWG	N/A	121586-5236

Hand Tools for Machined and Coaxial Contacts



This is a ratcheted, four indent crimp tool that is fully adjustable.

They crimp all sizes of machined and coaxial contacts.

Description	Hand Tool Part Number	Locator
Machined Crimp*	995-0001-585	192990-7600 (Calibrated) ¹

¹Nomenclature: TH-Trident
* M22520-1-01

Extraction Tools



Contacts can readily be removed from the housings using an extraction tool. The tool is placed over the contact and the sleeve rotated slightly as it is pushed home to release the spring. Light pressure on the knob then ejects the contact from the rear of the housing.

Part Number	
For Signal Contact	192922-1450

⚠ WARNING

Tooling & Handling: Care must be taken to avoid damage to any component parts of electrical connectors during installation and use. Although there are normally no sharp edges, care must be taken when handling certain components to avoid injury to fingers. Electrical connectors may be damaged in transit to the customers, and damage may result in creation of hazards. Products should therefore be examined prior to installation/use and rejected if found to be damaged.

Delivering a durable, reliable and innovative product for rail industrial and off road equipment

Mini Applicators (for Stamped Contacts)



Mini Applicators are interchangeable modules that will fit into many standard crimping machines. They are available for all sizes of stamped signal and power contacts.

AWG Size	Contact Description	Part Number
14-16	Trident Signal	121586-5240
16-18	Trident Signal	121586-5217
20-26	Trident Signal	121586-5239
12-14	Trident 30 A Power	*
14-16	Trident 30 A Power	*
18-20	Trident 30 A Power	*

* For details please consult the factory

Testing Gauge (for Stamped Contacts)



The testing gauge will be helpful to check whether a crimp is ok or not.

The contact should be inserted into the test fixture without scratching the test hole (diameter 3.3 mm).

	Part Number
Testing Gauge	317-8675-133

Pneumatic Table Crimp Tool (for Machined Contacts)

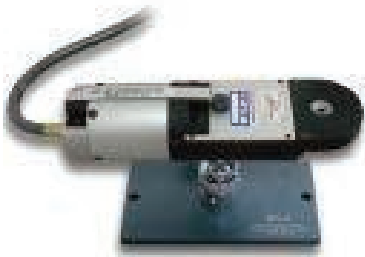

This Hand Crimp Tool fully meets the requirements of specification MIL-C-22520. The tool produces eight-indent crimp terminations of excellent quality. Together with the bench mount BM-2 and the foot pedal WA-10 it becomes an installed tool facilitating the work: The Hands of the operator are free to insert the contact and the wire and to remove the terminated contact.

Nomenclature	Description	Part Number	AWG
WA27F-CE	Pneumatic Crimp Tool	121586-5067	12-20
WA22F-CE	Pneumatic Crimp Tool	121586-5070	20-32
BM-2	Bench Mount	121586-5068	
WA10	Foot Pedal	121586-5069	

Semi-Automated Crimp Machine HACS-5 (for Machined Contacts)



With the semi-automated crimp machine HACS-5 machined contacts are terminated fast and reliably. 20 to 25 crimp terminations per minute can be achieved. The user has the choice between automatic and manual operation.

Nomenclature	Description	Part Number
HACS-5	Semi-Automated Crimp Machine	120090-0118

Electrical Data	
Protection Class: IP51	Electrical Power: 240 V ac, 50 Hz

⚠ WARNING

Tooling & Handling: Care must be taken to avoid damage to any component parts of electrical connectors during installation and use. Although there are normally no sharp edges, care must be taken when handling certain components to avoid injury to fingers. Electrical connectors may be damaged in transit to the customers, and damage may result in creation of hazards. Products should therefore be examined prior to installation/use and rejected if found to be damaged.





Visit our website at
www.ittcannon.com

Interconnect Solutions
Cannon, VEAM,
BIW Connector Systems











-  **Global Design & Manufacturing**
-  **Customer Support**







North America

-   **MEXICO - Cannon, VEAM**
Av.Libre Comercio s/n
entre Calzada Industrial
Nuevo Nogales y Calzada del Raquet Club,
Parque Industrial Nuevo Nogales
84093 Nogales, Sonora
phone: +52.631.3110050
fax: +52.631.3110060
-   **USA - Cannon**
666 East Dyer Road
Santa Ana, CA 92705
toll free: +1.800.854.3028
phone: +1.714.557.4700
fax: +1.714.628.2142
-   **USA - BIW Connector Systems**
500 Tesconi Circle
Santa Rosa, CA 95401
phone: +1.707.523.2300
fax: +1.707.523.3567
-   **USA - VEAM**
100 New Wood Road
Watertown, CT 06795
phone: +1.860.274.9681
fax: +1.860.274.4963

Europe & Middle East

-  **FRANCE - Cannon, VEAM**
15, Boulevard Robert Thiboust
77700 Serris
phone: +33.1.60.04.93.93
fax: +33.1.60.04.93.90
-   **GERMANY - Cannon, VEAM**
ITT Cannon GmbH
Cannonstrasse 1
71384 Weinstadt
phone: +49.7151.699.0
fax: +49.7151.699.217
-   **ITALY - Cannon, VEAM**
Corso Europa 41/43
20020 Lainate (MI)
phone: +39.02938721
fax: +39.0293872300
-  **LEBANON - BIW Connector Systems**
P.O. Box 199
Jounieh
Lebanon
phone: +961.9.911.560
fax: +961.9.912.126
-   **UK - Cannon, VEAM**
Jays Close, Viabes Estate
Basingstoke
RG22 4BA
phone: +44.1256.311200
fax: +44.1256.323356

Asia

-   **CHINA - Cannon, VEAM**
Tuopandun Industrial Area,
Jinda Cheng, Xiner Village, Shajing Town,
Baoan District, Shenzhen City,
Guangdong Province, 518125
phone: +86.755.2726.7238
fax: +86.755.2726.7515
-  **HONG KONG - Cannon, VEAM**
Units 2405-6, 24/F, ING Tower
308 Des Voeux Road Central
Hong Kong
phone: +852.2732.2720
fax: +852.2732.2919
-  **INDIA - Cannon, VEAM**
ITT Corporation India Pvt. Ltd.
Money Chamber, Unit No. 202
#6, KH Road
Bangalore 560027
phone: +91.80.41465632
fax: +91.80.41465631
-   **JAPAN - Cannon, VEAM**
5-11-3 Hibarigaoka, Zama-shi
Kanagawa 252-0003
phone: +81.462.57.2010
fax: +81.462.57.1680
-  **SINGAPORE - Cannon, VEAM**
10 Jalan Kilang #06-01
159410 Singapore
phone: +65.62763693 ext 232
fax: +65.62763685



ENGINEERED FOR LIFE

The "ITT Engineered Blocks" symbol, "Engineered for life", "ITT", "Cannon", "Veam" and "BIW Connector Systems" are registered trademarks of ITT Corporation. Specification and other data are based on information available at the time of printing, and are subject to change without notice.
© 2012 ITT Corporation