

阅读申明

- 1.本站收集的数据手册和产品资料都来自互联网，版权归原作者所有。如读者和版权方有任何异议请及时告之，我们将妥善解决。
- 2.本站提供的中文数据手册是英文数据手册的中文翻译，其目的是协助用户阅读，该译文无法自动跟随原稿更新，同时也可能存在翻译上的不当。建议读者以英文原稿为参考以便获得更精准的信息。
- 3.本站提供的产品资料，来自厂商的技术支持或者使用者的心得体会等，其内容可能存在描述上的差异，建议读者做出适当判断。
- 4.如需与我们联系，请发邮件到marketing@iczoom.com，主题请标有“数据手册”字样。

Read Statement

1. The datasheets and other product information on the site are all from network reference or other public materials, and the copyright belongs to the original author and original published source. If readers and copyright owners have any objections, please contact us and we will deal with it in a timely manner.
2. The Chinese datasheets provided on the website is a Chinese translation of the English datasheets. Its purpose is for reader's learning exchange only and do not involve commercial purposes. The translation cannot be automatically updated with the original manuscript, and there may also be improper translations. Readers are advised to use the English manuscript as a reference for more accurate information.
3. All product information provided on the website refer to solutions from manufacturers' technical support or users the contents may have differences in description, and readers are advised to take the original article as the standard.
4. If you have any questions, please contact us at marketing@iczoom.com and mark the subject with "Datasheets" .

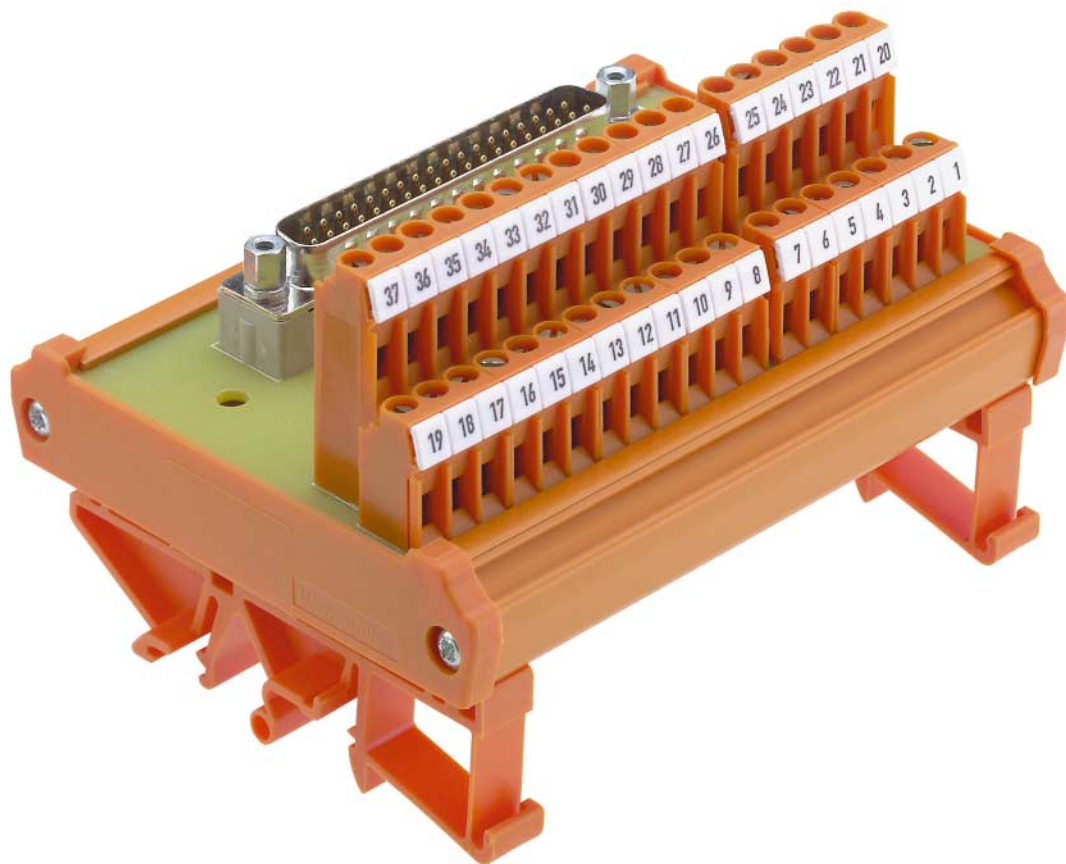

Weidmüller Interface Units

From the point of view of saving costs when producing switchgear cabinets, interface units offer an alternative concept to the wiring of single conductors. The main task of interface units is the trouble-free conversion of standardised plug-in connector systems to single conductor wiring or to another connection system.

Interface units are composed of the following components:

- extrusion profile for insertion of the card
- end plate for mounting rail installation
- mounting feet for installing onto standardised TS 32 and TS 35 mounting rails
- printed-circuit board with connection and indicating elements, preassembled DIN plug-in connectors and tag carriers for marking electrical equipment

The plug-in connectors used in the interface units are divided into the following groups:

- ribbon cable plug-in connectors according to IEC 603-1/DIN 41 651.
- subminiature connectors (SUB-D) according to IEC 807-2/DIN 41 652.
- connectors for printed circuits according to IEC 603/DIN 41 612 and 41 617.
- ELCO connectors for EXi applications in the processing industry

Pre-assembled cables with corresponding plug-in connector systems are used for connections between higher-level controls and interface units.

This is where the user has the largest potential for saving costs. The use of system cables with large numbers of poles considerably reduces wiring costs, consisting of wage and material costs. The conversion to single conductor wiring is made directly at the interface unit. The user is offered screw / tension clamp or plug-in connections to connect actuators and sensors. Optional additional functions such as status indicators, signal separation, fuses or shielding can be integrated. Marking systems ease the task of assigning signals to the respective elements.

Advantages of interface units:

- space-saving mounting by using two and three tier card connection elements.
- cost saving, unilateral conventional single conductor wiring.
- more protection against faulty wiring.
- additional options: Status indication by integrating LEDs on the interface unit.
- faster troubleshooting thanks to additional test and measurement devices.
- simplified commissioning and documentation.

Using interface units allows trend-setting rationalisation concepts to be carried out in switchgear cabinet manufacturing. Not only do they reduce the share of pure labour costs of wiring tasks, but also the share of costs for materials, such as cable and conductors, cable ducts, terminal blocks and terminal boxes.

Customer-specific wiring concepts are efficiently put into practice by the use of special interface units.

Interface unit RSF for ribbon cables in accordance with IEC 603-1/DIN 41 651



Passive interface for 10...64 signals to adapt pre-assembled ribbon cable plug-in connectors to a screw or tension clamp connection in accordance with IEC 603-1/ DIN 41 651.

Combined with an LED status indicator, the modules provide rapid information on the switching status of incoming and outgoing signals within a control unit.

Interface unit RSSD for subminiature plug-in connectors (SUB-D) in accordance with IEC 807-2/DIN 41 652



Passives interface for 9 ... 50 signals for conversion of preassembled cables with SUB-D connectors in accordance with IEC 807-2/DIN 41 652 to screw or tension clamp connection technology. The modules are delivered with either socket strips (female) or pin headers (male). A spacer block between the plug-in connectors and the card takes up the mechanical forces created by the connected cable. RSSD interface units are optionally available with a frame terminal for connecting shielded conductors. An additional potential connection eases testing and measuring during commissioning and maintenance tasks.

RS VERT interface units as potential distributors

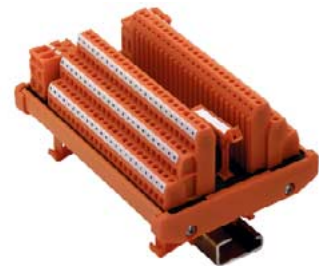

Passive interface for distributing DC supply voltages. The interface units are available in three versions for distribution to 8, 16 and 72 connection elements for the positive and negative potentials.

- 8- 16-channel distributors in 45-mm, 72-channel distributors in 100-mm widths.
- power supply via two connection elements respectively for positive and negative potentials.
- Mount on to TS 32/35 mounting rails.

RS VERT potential distributors can be installed in small distributor boxes, and provide a clearly arranged potential distribution.

Interface Units

Interface units RSELCO for hermaphroditic plugs



Passive interface to convert hermaphroditic ELCO multipole connectors to input and output with screw connections.

Hermaphroditic contacts are achieved by a fork that is identical at both ends of the connection.

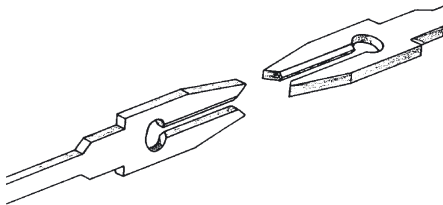

The advantage of this type of connector is essentially the large contact area (making it suitable for low currents), the long operational lifetime, and the high resistance to shock and vibration.

An adjustment screw eases insertion, and ensures a reliable interlock of the pair of connectors.

All types are available as "left" and "right" versions.

All interface units are supplied individually marked with consecutive numbering, and can be fitted with 6-digit group markers. The universal foot allows all modules to be assembled onto TS 32, TS 35x7.5 and TS 35x15 mounting rails in accordance with the European standards EN 50 035 and EN 50 022.

Interface unit RSDIN for plug-in connectors according to IEC 603/ DIN 41 612 and 41 617



Passive interface for adapting the female and male connector blocks in the design versions B, C, D and F with screw connections.

Card holders for adapting rack cards in Euro format to plug-in connectors according to IEC603 / DIN 41612 and DIN 41617



Card holders enable the fast conversion of electronic components.

As with interface units, IEC 803/ DIN 41612/617 plug-in connectors on card holders are converted to screw /push-on connection technology.

The card holders are constructed as follows:

- card with PCB terminals and standardised plug-in connector for mounting an electronic module in 19" Euro format: 160x100 or 233x160 mm
- retention pillars and interlock for securing the card
- mounting plate and mounting foot for mounting directly or onto mounting rails.

The SKH2 card holder range is distinguished by its design and functionality

- 19" Euro card completely protected at the rear against foreign bodies.
- eject mechanism guarantees one-hand operation
- electronic module can be secured to the front, similar to the 19" rack

Card holders are used in industrial applications where individual 19" modules need to be quickly adapted, but the costs for 19" card racks are too high. Card racks are voluminous, and are generally only accessible from the rear. As a rule, they do not have screw / tension clamp connections for external wiring, which makes them difficult to handle for wiring purposes.

Card holders are considered in the first place

- if only a few cards are to be installed and connected
- if the conductor card is placed decentralized, i.e., favourable for wiring
- if older installations are to be extended with additional electronic modules

Other typical applications are test equipment and testing modules in production processes and laboratories.

This is where a fast exchange of the card and an optimum handling of the connection level are of a premium.

Standards

The following standards are fulfilled:

EN 50178 Fitting heavy voltage installations with electronic equipment

DIN VDE 0109 Coordination of insulation in low voltage installations including clearance and creepage distances for assembled cards.

Interface Units

For ribbon cable connections according to IEC 603-1/DIN 41 651

- With fixing foot for TS 32, TS 35 x 7.5 and TS 35 x 15
- Male connector block with interlock for female connector block with strain relief according to DIN 41 651/ Parts1 and 2
- RSF on FS 45 profile is equipped with an additional potential connection for test purposes
- Optionally available with tension clamp or Screw connection

RSF ... Z

Interface units for ribbon cables
Tension clamp

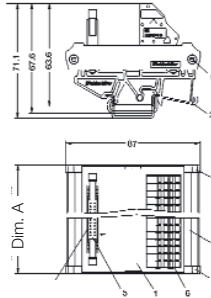

RSF

Interface units for ribbon cables on RS 45-profile
Screw connection

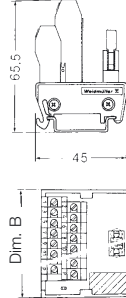
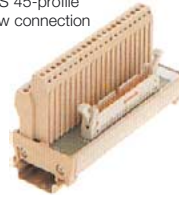

RSF

Without status indicator
Screw connection

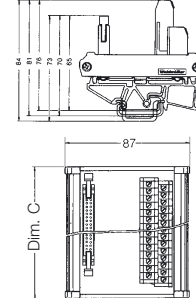

RSF

Without status indicator
Screw connection

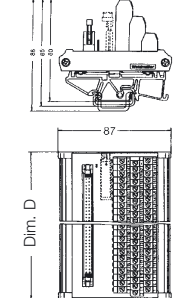

Ordering data/dimensions (mm)

Poles	Dim. A	Dim. B	Dim. C	Dim. D
10	50	49	50	40
14	50	56	50	45
16	55	64	55	50
20	65	71	65	50
26	80	86	80	55
34	110	106	110	70
40	115	121	115	80
50	145	151	145	95
60	180	180	180	115
64	180	186	180	120

On TS 35 x 7.5

Dimensions

Insulation stripping length: 7.5 mm
Overall width: See table, dim. A

Connection cross-section

max. terminal range in mm²:
Screw connection, solid H07V-U: 0.5...2.5 mm²
Screw connection, flexible H07V-U: 0.5...1.5 mm²
Screw connection, flexible H07V-U with AEH/DIN 46228/1/4: 0.25...1.5 mm²

Conductor cross-section: AWG 26...16
Conversion connection level/plug connection: 1: 1
Housing/socket type: RS 80 profile/TS 32 and TS35
Connection type: - Process side: LM2NZF terminal
- Type: LPK 2 H terminal
- Control side: Plug connection
- Type: Ribbon connector i.a.w. to DIN 41 651 / IEC 603-1

Rated data

Rated voltage: 60 V~, 75 V~
Rated current per contact: 1 A
Rated cross-section: 1.5 mm²
Test voltage: 1 kV-eff
Ambient temperature: 0 °C...+55 °C
Storage temperature: -40 °C...+70 °C

Insulation coordination according to EN 50 178

Overvoltage category: III
Pollution degree: 2

Accessories

Mounting rail: TS 32 (0122800000), TS 35 x 7.5 (0383400000), TS 35 x 15 (0498000000)
End bracket: for TS 32 (EWK 2, 0199360000), for TS 35 (EW 35, 0383560000)

Tag carrier type: SchT 7/2 (1359360000), ESO 7 (0515200000), STR 7 (0515300000)
Insert tag (unprinted):
Protective strip, transparent:

Type	Cat. No.	Type	Cat. No.	Type	Cat. No.	Type	Cat. No.
RSF 10 Z	8537190000	RSF 10	8155610000	RSF 10	0224961001	RSF 10	8012850000
RSF 14 Z	8537200000	RSF 14	8258980000	RSF 14	0225061001	RSF 14	8012860000
RSF 16 Z	8537210000	RSF 16	8265540000	RSF 16	0225161001	RSF 16	8012870000
RSF 20 Z	8537110000	RSF 20	8155600000	RSF 20	0224261001	RSF 20	8012910000
RSF 26 Z	8537180000	RSF 26	8213470000	RSF 26	0224861001	RSF 26	8012920000
RSF 34 Z	8537130000	RSF 34	8155590000	RSF 34	0224361001	RSF 34	8012930000
RSF 40 Z	8537140000	RSF 40	8155580000	RSF 40	0224461001	RSF 40	8012940000
RSF 50 Z	8537150000	RSF 50	8155570000	RSF 50	0224561001	RSF 50	8012950000
RSF 60 Z	8537160000	RSF 60	8259000000	RSF 60	0224661001	RSF 60	8012960000
RSF 64 Z	8537170000	RSF 64	8155550000	RSF 64	0224761001	RSF 64	8012970000

Intended for tag carrier
Type SchT 7/2
Cat. No. 1359360000

Type	Cat. No.	Qty.	Type	Cat. No.	Qty.	Type	Cat. No.	Qty.	Type	Cat. No.	Qty.
TS 32	0122800000	-	TS 32	0122800000	-	TS 32	0122800000	-	TS 32	0122800000	-
TS 35 x 7.5	0383400000	-	TS 35 x 7.5	0383400000	-	TS 35 x 7.5	0383400000	-	TS 35 x 7.5	0383400000	-
TS 35 x 15	0498000000	-	TS 35 x 15	0498000000	-	TS 35 x 15	0498000000	-	TS 35 x 15	0498000000	-
EWK 2	0199360000	50	EWK 2	0199360000	50	EWK 2	0199360000	50	EWK 2	0199360000	50
EW 35	0383560000	50	EW 35	0383560000	50	EW 35	0383560000	50	EW 35	0383560000	50

1) The additional clause in EN 50 178 and in IEC 807-2/DIN 41 652 are to be observed when used in industrial installations.

Interface Units

For sub miniature plug-in connectors according to IEC 807-2/DIN 41 652

- With fixing foot for TS 32, TS 35 x 7.5 and TS 35 x 15
- Male and female connectors with screw/locking system UNC 4/40
- RSF on FS 45 profile is equipped with an additional potential connection for test purposes
- Optionally available with tension clamp or screw connection

RSSD

Male and female connector
Tension clamp

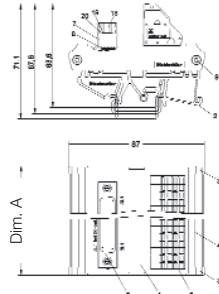

RSSD

Interface units
for male and female connectors on RS 45-profile
Screw connection

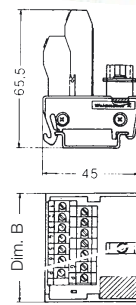

RSSD S

Male connector
without status indicator
Screw connection

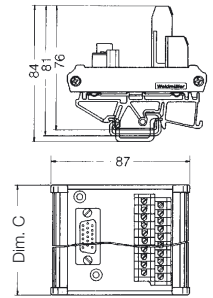

RSSD B

Female connector
without status indicator
Screw connection

Ordering data/Dimensions (mm)			
Poles	Dim. A	Dim. B	Dim. C
9	45	50	45
15	60	61	60
25	80	86	80
37	110	116	110
50	145	154	145

On TS 35 x 7.5

Type	Cat. No.
Male connector	
RS SD 9 S	8537260000
RS SD 15 S	8537390000
RS SD 25 S	8537370000
RS SD 37 S	8537240000
RS SD 50 S	8537350000

Female connector	
RS SD 9 B	8537320000
RS SD 15 B	8537400000
RS SD 25 B	8537380000
RS SD 37 B	8537250000
RS SD 50 B	8537360000

Type	Cat. No.
Male connector	
RSSD 9 S	8259010000
RSSD 15 S	8233350000
RSSD 25 S	8155650000
RSSD 37 S	8155660000
RSSD 50 S	8155670000

Female connector	
RSSD 9 B	8216480000
RSSD 15 B	8209730000
RSSD 25 B	8155620000
RSSD 37 B	8155630000
RSSD 50 B	8155640000

Type	Cat. No.
Male connector	
RSSD 9 S	8003901001
RSSD 15 S	8005201001
RSSD 25 S	8005181001
RSSD 37 S	8003881001
RSSD 50 S	8005161001

Female connector	
RSSD 9 B	8003911001
RSSD 15 B	8005211001
RSSD 25 B	8005191001
RSSD 37 B	8003891001
RSSD 50 B	8005171001

Dimensions

Insulation stripping length
Overall width

Connection cross-section

Max. terminal range in mm²
Screw connection, solid H07V-U
Screw connection, flexible H07V-U
Screw connection, flexible H07V-U with AEH/DIN 46228/1/4

Conductor cross-section
Conversion connection level/plug connection

Housing/socket type
Connection type

- Process side
- Type
- Control side
- Type

Rated data

Rated voltage
Rated current per contact
Rated cross-section
Test voltage
Ambient temperature
Storage temperature

Insulation coordination according to EN 50 178

Overvoltage category
Pollution degree

Accessories

Mounting rail	
End bracket	for TS 32 for TS 35
Screw lock	
Tag carrier type	
Insert tag (unprinted)	
Protective strip, transparent	

With UNC 4/40 interlock

Insulation stripping length	7.5 mm
Overall width	See table, dim. A
Max. terminal range in mm ²	0.5...2.5 mm ² 0.5...1.5 mm ² 0.25...1.5 mm ²
Conductor cross-section	AWG 26...16
Conversion connection level/plug connection	1 : 1
Housing/socket type	RS 80 profile/TS 32 and TS 35
Connection type	Tension clamp connection LM2NZF terminal Plug connection Sub-D i.a.w. DIN 41 652 IEC 807-2

With UNC 4/40 interlock

Insulation stripping length	7 mm
Overall width	See table, dim. B
Max. terminal range in mm ²	0.5...2.5 mm ² 0.5...1.5 mm ²
Conductor cross-section	AWG 26...16
Conversion connection level/plug connection	1 : 1
Housing/socket type	RS 45 profile/TS 35
Connection type	Screw connection LPK 2 H terminal Plug connection Sub-D i.a.w. DIN 41 652 IEC 807-2

With UNC 4/40 interlock

Insulation stripping length	7 mm
Overall width	See table, dim. C
Max. terminal range in mm ²	0.5...4 mm ² 0.5...4 mm ²
Conductor cross-section	AWG 26...14
Conversion connection level/plug connection	1 : 1
Housing/socket type	RS 80 profile/TS 32 and 35
Connection type	Screw connection LP2N terminal Plug connection Sub-D i.a.w. DIN 41 652 IEC 807-2

With UNC 4/40 interlock

Insulation stripping length	7 mm
Overall width	See table, dim. C
Max. terminal range in mm ²	0.5...4 mm ² 0.5...4 mm ²
Conductor cross-section	AWG 26...14
Conversion connection level/plug connection	1 : 1
Housing/socket type	RS 80 profile/TS 32 and 35
Connection type	Screw connection LP2N terminal Plug connection Sub-D i.a.w. DIN 41 652 IEC 807-2

Type	Cat. No.	Qty.	Type	Cat. No.	Qty.	Type	Cat. No.	Qty.	Type	Cat. No.	Qty.
TS 32	0122800000	-	TS 35 x 7.5	0383400000	-	TS 32	0122800000	-	TS 32	0122800000	-
TS 35 x 7.5	0383400000	-	TS 35 x 15	0498000000	-	TS 35 x 7.5	0383400000	-	TS 35 x 7.5	0383400000	-
TS 35 x 15	0498000000	-				TS 35 x 15	0498000000	-	TS 35 x 15	0498000000	-
EWK 2	0199360000	50	EWK 2	0199360000	50	EWK 2	0199360000	50	EWK 2	0199360000	50
EW 35	0383560000	50	EW 35	0383560000	50	EW 35	0383560000	50	EW 35	0383560000	50
SUB-D 4/40	1155000000	2	SUB-D 4/40	1155000000	2	SUB-D 4/40	1155000000	2	SUB-D 4/40	1155000000	2
						ESO 7	0515200000	10	SchT 7/2	1359360000	20
						STR 7	0515300000	10	ESO 7	0515200000	10
									STR 7	0515300000	10

1) The additional clause in EN 50 178 and in IEC 807-2/DIN 41 652 are to be observed when used in industrial installations

Interface Units

For sub miniature plug-in connectors according to IEC 807-2/DIN 41 652

- With fixing foot for TS 32, TS 35 x 7.5 and TS 35 x 15
- Male and female connectors with screw/locking system UNC 4/40
- 3-tier connection elements reduce module size
- Ground connection for shielded cables
- Test connection for measurement purposes

RSSD S
Male connector
without status indicator
Screw connection

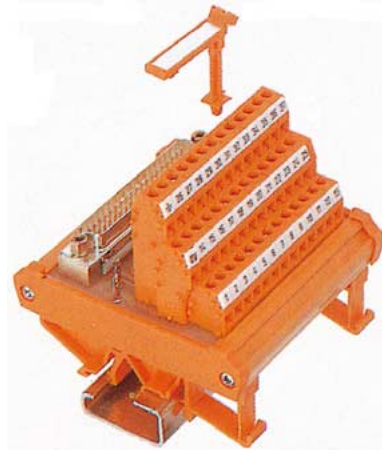

RSSD B
Female connector
without status indicator
Screw connection

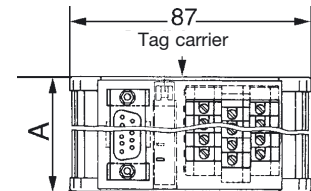
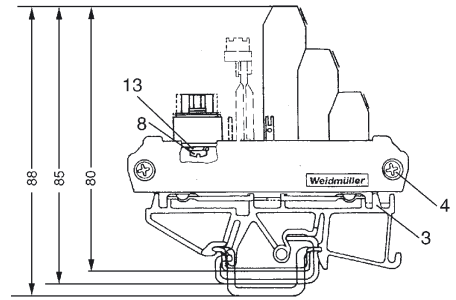

Ordering data/dimensions (mm)

Poles	Dim. A
9	40
15	45
25	60
37	80
50	100

Type	Cat. No.	Type	Cat. No.
Male connector		Female connector	
RSSD 9 S	8019930000	RSSD 9 B	8019880000
RSSD 15 S	8019940000	RSSD 15 B	8019890000
RSSD 25 S	8019950000	RSSD 25 B	8019900000
RSSD 37 S	8019960000	RSSD 37 B	8019910000
RSSD 50 S	8019970000	RSSD 50 B	8019920000

designed for tag carrier SchT 7/2
Cat. No. 1359360000

designed for tag carrier SchT 7/2
Cat. No. 1359360000

Lock to UNC 4/40

Lock to UNC 4/40

Dimensions

Insulation stripping length
Overall width

7 mm
See table, dim. A

7 mm
See table, dim. A

Connection cross-section

Screw connection, solid
Screw connection, flexible
Conductor cross-section
Conversion connection level/plug connection
Housing/socket type
Connection type
- Process side
- Type
- Control side
- Type

0.5...2.5 mm²
0.5...1.5 mm²
AWG 26...16
1 : 1
RS 80 profile/TS 32 and 35
Screw connection
LPK 3 terminal
Plug connection
Sub-D i.a.w. DIN 41 652
IEC 807-2

0.5...2.5 mm²
0.5...1.5 mm²
AWG 26...16
1 : 1
RS 80 profile/TS 32 and 35
Screw connection
LPK 3 terminal
Plug connection
Sub-D i.a.w. DIN 41 652
IEC 807-2

Rated data

Rated voltage
Rated current per contact
Rated cross-section
Test voltage
Ambient temperature
Storage temperature

125 V~, 150 V~¹⁾
1.5 A
1.5 mm²
1 kV~eff
0 °C...+55 °C
-40 °C...+70 °C

125 V~, 150 V~¹⁾
1.5 A
1.5 mm²
1 kV~eff
0 °C...+55 °C
-40 °C...+70 °C

Insulation coordination according to EN 50 178

Overvoltage category
Pollution degree

III
2

III
2

Accessories

Mounting rail

End bracket for TS 32
for TS 35

Screw lock
Tag carrier type
Insert tag (unprinted)
Protective strip, transparent

Type	Cat. No.	Qty.	Type	Cat. No.	Qty.
TS 32	0122800000	-	TS 32	0122800000	-
TS 35 x 7.5	0383400000	-	TS 35 x 7.5	0383400000	-
TS 35 x 15	0498000000	-	TS 35 x 15	0498000000	-
EWK 2	0199360000	50	EWK 2	0199360000	50
EW 35	0383560000	50	EW 35	0383560000	50
SUB-D 4/40	1155000000	2	SUB-D 4/40	1155000000	2
SchT 7/2	1359360000	20	SchT 7/2	1359360000	20
ESO 7	0515200000	10	ESO 7	0515200000	10
STR 7	0515300000	10	STR 7	0515300000	10

¹⁾ The additional clause in EN 50 178 and in IEC 807-2/DIN 41 652 are to be observed when used in industrial installations

Interface Units

Distributors for 8, 16 and 72 positive and negative potentials

- Adapts 2 supply connections to 8/16 or 72 potential distribution terminals
- Potential distributor designed as two- or three-tier connection element
- RS VERT8 and RS VERT16 offer clearly arranged potential distribution in tight spaces. They are designed for residual currents of 10 A.
- RS LPK3/144 VERT is designed for residual currents of 20A.

RS VERT8 LPK2

RS VERT16 LPK2

RS LPK3/144 VERT

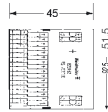
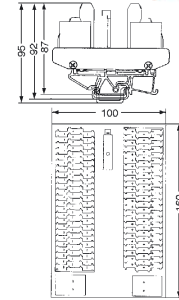
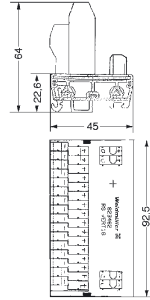
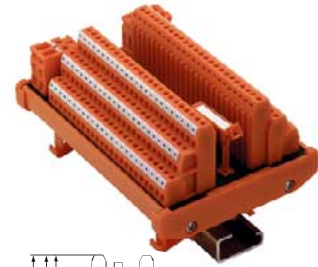

Ordering data/Dimensions (mm)	Type	Cat. No.	Type	Cat. No.	Type	Cat. No.
	RS VERT 8 LPK2	8252010000	RS VERT 16 LPK2	8234620000	RS LPK3/144 VERT	8199510000
Dimensions						
Insulation stripping length	7 mm		7 mm		7 mm	
Overall width	51.5 mm		92.5 mm		160 mm	
Connection cross-section						
Screw connection, solid core	0.5...2.5 mm ²		0.5...2.5 mm ²		0.5...2.5 mm ²	
Screw connection, flexible	0.5..0.1.5 mm ²		0.5..0.1.5 mm ²		0.5..0.1.5 mm ²	
Conductor cross-section	AWG 26...16		AWG 26...16		AWG 26...16	
Housing/socket type	RS 45 profile/TS 35		RS 45 profile/TS 35		RS 100 profile/TS 32 and 35	
Rated data						
Rated voltage	24 V0		24 V0		250 V-	
Max. residual current supply	10 A		10 A		20 A	
Potential distribution "plus"/"minus"	8		16		72	
Rated cross-section	1.5 mm ²		1.5 mm ²		1.5 mm ²	
Max. output current per terminal	5 A		5 A		10 A	
Ambient temperature	0 °C...+55 °C		0 °C...+55 °C		0 °C...+55 °C	
Storage temperature	-40 °C...+70 °C		-40 °C...+70 °C		-40 °C...+70 °C	
Insulation coordination according to EN 50 178						
Overvoltage category	III		III		III	
Pollution degree	2		2		2	
Accessories						
Mounting rail						
	TS 35 x 7.5	0383400000 -	TS 35 x 7.5	0383400000 -	TS 32	0122800000 -
	TS 35 x 15	0498000000 -	TS 35 x 15	0498000000 -	TS 35 x 7.5	0383400000 -
					TS 35 x 15	0498000000 -
End bracket	for TS 32		EW 35	0383560000 -	EWK 2	0199360000 -
	for TS 35				EW 35	0383560000 -
Tag carrier type					SchT 7/2	1359360000 -
Insert tag (unprinted)					ESO 7	0515200000 -
Protective strip, transparent					STR 7	0515300000 -

Interface Units

For hermaphroditic plugs

RSELCO

Short, 56-pole

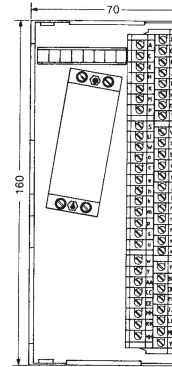
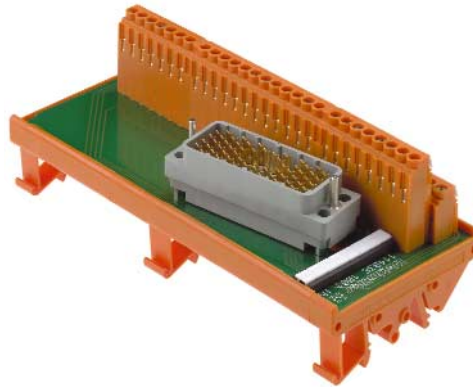
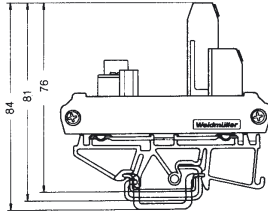

Pin assignment:

LP2N screw terminal | ELCO plug

1	A
2	B
•	•
•	•
19	W
20	X
Y	Y
21	a
22	b
•	•
•	•
42	z
43	AA
44	BB
•	•
•	•
32	n
33	p
34	r
•	•
•	•
42	z
43	AA
44	BB
•	•
•	•
53	MM
54	NN
Y	Y

Ordering data		Type	Cat. No.
		RSELCO, left	1149361001
		RSELCO, right	1149461001
Dimensions			
Insulation stripping length		7 mm	
Overall width		160 mm	
Connection cross-section			
Screw connection, solid		0.5...4 mm ²	
Screw connection, flexible		0.5...2.5 mm ²	
Conductor cross-section		AWG 26...14	
Conversion connection level/plug connection		1 : 1	
Housing/socket type		RS 70 profile/TS 32 and 35	
Connection type		- Process side - Type - Control side - Type	Plug connection ELCO type 8016 Screw connection LP2N terminal
Rated data			
Rated voltage		125 V~	
Rated current per contact		1.5 A	
Rated cross-section		2.5 mm ²	
Test voltage		1.5 kV~eff	
Ambient temperature		0 °C...+55 °C	
Storage temperature		-40 °C...+70 °C	
Insulation coordination according to EN 50 178			
Overvoltage category		III	
Pollution degree		2	
Accessories		Cat. No.	Cat. No. Qty.
Mounting rail		TS 32	0122800000 -
		TS 35 x 7.5	0383400000 -
		TS 35 x 15	0498000000 -
End bracket		for TS 32	EWK 2 0199360000 50
		for TS 35	EW 35 0383560000 50
Screw lock			
Insert tag (unprinted)		DEK5	page 312

Interface Units

Plug-in connectors designs in accordance with IEC 603/DIN 41612

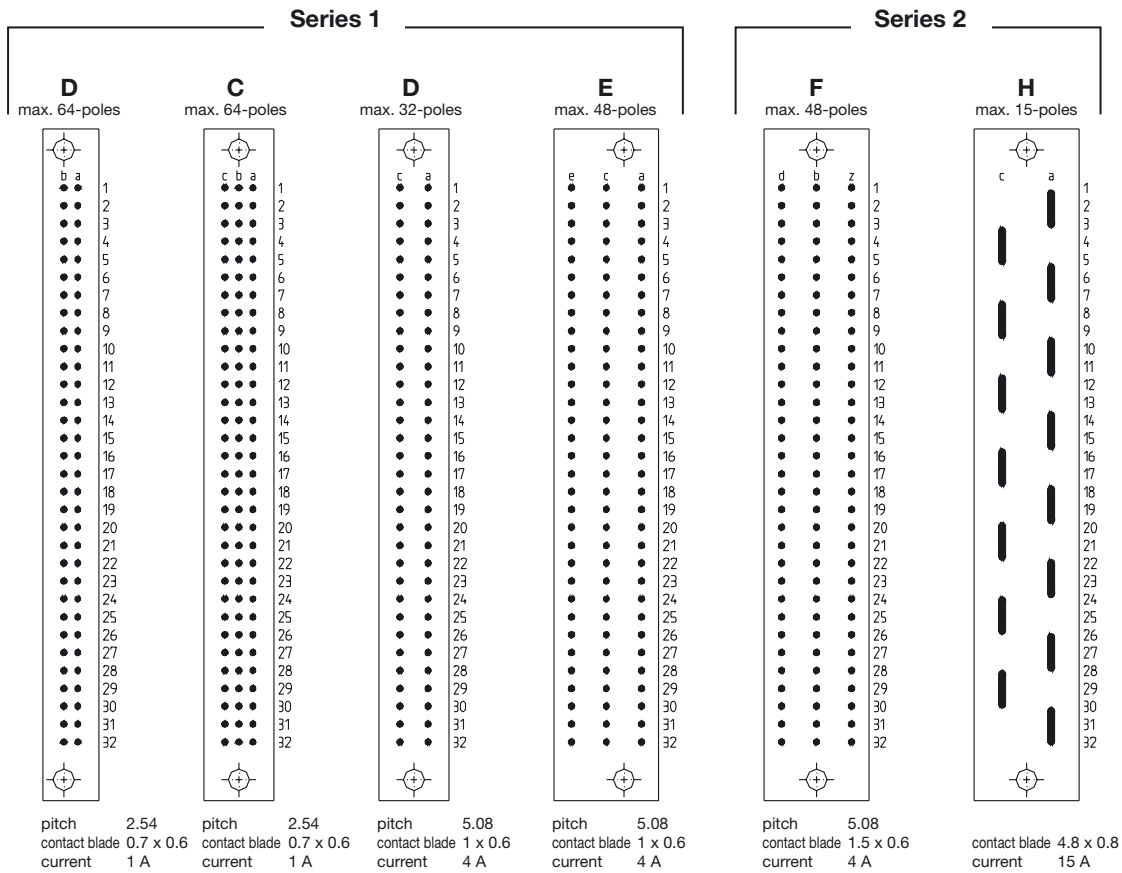

Production series 1

Plug-in connectors from this production series are of conventional, high-pole design with low contact distances and a max. current carrying capacity of 1 A. In addition, there are versions commercially available on the market with up to 4 A contact currents in 5.08-mm grid with less poles (up to 48).

Design B

A 64-pole plug-in connector with row assignment a and b, and a contact current capacity of max. 1A. The rated voltage is defined in accordance with IEC 664/ EN 50178 as 125 V. A variant is a 32-pole version, where only the odd number poles are assembled.

Design C

An extension of design B; the addition of contact row c results in a 96-pole plug-in connector. An alternative design is type C 64, with which the outer rows c and a are assembled. A further reduction of the assembly results in the design C 32, with a vertical and horizontal contact grid dimension of 5.08 mm.

Design D

The dimensions and contact arrangement are identical with the C 32 design. The strengthened contacts can be loaded with up to 4 A.

Design E

An extension of the design D 32; the addition of the contact row e results in the 48-pole version of design E. With 4 A contact current in 5.08-mm grid dimension, this plug-in connector has been designed for heavy current loads. All even numbered poles are assembled in the contact rows e, c and a.

Production series 2

This design differs from that of the design 1 with its differing grid dimensions of the rear connections of 5.08 mm and the contact rows of 3.81 mm on the mating face. The plastic housing has been designed to be higher at the back in order to increase the creepage distances (metal plate, PCB etc.). This results in an altered wiring level when compared with production series 1. The contacts have fundamentally been designed for a current carrying capacity of 4 A. These plug-in connectors are largely used for applications in power electronics. The fixing holes are arranged on the outside of the blocks in the middle.

Design F

48-pole, fully assembled contact rows d, b and z. Variants with part assembly of the rows z and b or z and d in 32-pole design are commercially available. The distinguishing feature of the designs with the contact variation z/d is their larger insulating distances.

Design H

These have the same dimensions as design F, and are assembled 11- or 15-pole high-current contacts. The plugging geometry differs from the other designs. The contacts have a current carrying capacity of max. 15 A.

Interface Units

For converting IEC 603/DIN 41 612 plug-in connectors

to LP connection elements for mounting rail or 19" rack installation

RSDIN F 64 B

Female/male connector block

RSDIN F 48 B

Female connector block

RSDIN F 48 S

Male connector block

RSDIN 19"

Female connector block

RSDIN C 64

Female/male connector block

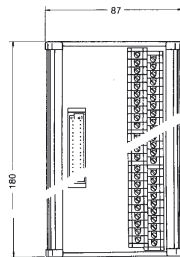
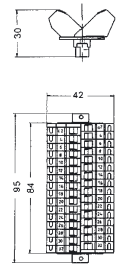
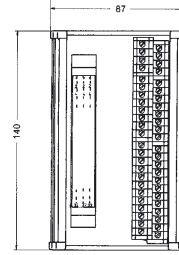
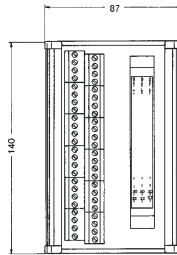
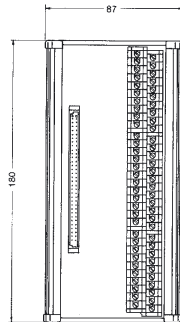
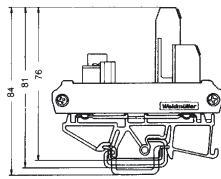
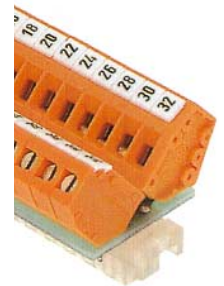
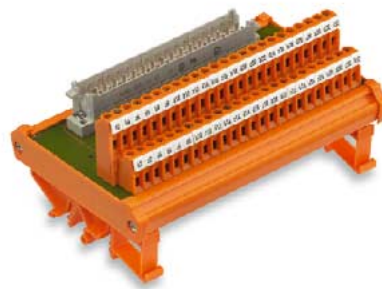
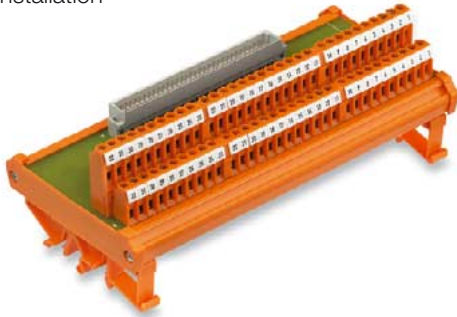

Ordering data		RSDIN C 64 B*		RSDIN F 48 B	RSDIN F 48 S	RSDIN F 48 S	RSDIN
Type		1127461001		1177960000	1178360000	1178260000	8019730000
Cat. No.		1178061001					
Type		B 64	C 64	F 48	F 48	F 48	D 32
Cat. No.		DIN 41 612	DIN 41 612	DIN 41 612	DIN 41 612	DIN 41 612	DIN 41 612
		a and b	a 1 and c 1	d 2, b 2 and z 2	d 2, b 2 and z 2	d 2, b 2 and z 2	a and c
Connection type (screw connection)		LP2N	LP2N	GSD 5	LP2N	LP2N	Screw connection
Dimensions		7 mm	7 mm	7 mm	7 mm	7 mm	7 mm
Insulation stripping length		180 mm	180 mm	140 mm	140 mm	140 mm	84 mm
Overall width		0.13...4 mm ²		0.13...1.5 mm ²	0.13...4 mm ²	0.13...4 mm ²	0.13...4 mm ²
Clampable conductors		0.5...4 mm ²	0.5...4 mm ²	0.5...1.5 mm ²	0.5...4 mm ²	0.5...4 mm ²	0.5...4 mm ²
Max. clamping range		0.5...2.5 mm ²	0.5...2.5 mm ²	0.5...1.5 mm ²	0.5...2.5 mm ²	0.5...2.5 mm ²	0.5...2.5 mm ²
„e“ solid HO7V-U		0.5...2.5 mm ²	0.5...2.5 mm ²	0.5...1.5 mm ²	0.5...2.5 mm ²	0.5...2.5 mm ²	0.5...2.5 mm ²
„f“ flexible HO7V-K		AWG 26...14	AWG 26...14	AWG 26...16	AWG 26...14	AWG 26...14	AWG 26...14
„f“ with ferrules		A3	A3	A1	A3	A3	A3
According to DIN 46228/1	Size	125 V~	125 V~	125 V~	125 V~	125 V~	125 V~
With plastic collar		1.5 A (max. 45 °C amb. temp.)	1.5 A (max. 45 °C amb. temp.)	1.5 A (max. 45 °C amb. temp.)	1.5 A (max. 45 °C amb. temp.)	1.5 A (max. 45 °C amb. temp.)	4 A (max. 45 °C amb. temp.)
Conductor cross-section		2.5 mm ²	2.5 mm ²	1.5 mm ²	1.5 mm ²	1.5 mm ²	1.5 mm ²
Plug gauge according to DIN/EN 50027		0.5 kV~eff	0.5 kV~eff	0.5 kV~eff	0.5 kV~eff	0.5 kV~eff	2 kV~eff
Rated data		0.4 Nm	0.4 Nm	0.4 Nm	0.4 Nm	0.4 Nm	0.4 Nm
Rated voltage		0 °C...+55 °C	0 °C...+55 °C	0 °C...+55 °C	0 °C...+55 °C	0 °C...+55 °C	0 °C...+55 °C
Rated current per contact		-40 °C...+70 °C	-40 °C...+70 °C	-40 °C...+70 °C	-40 °C...+70 °C	-40 °C...+70 °C	-40 °C...+70 °C
Rated cross-section		III	III	III	III	III	III
Test voltage		2	2	2	2	2	2
Test torque		* Female connector block		** Male connector block			
Ambient temperature							
Storage temperature							
Insulation coordination according to EN 50 178							
Overvoltage category							
Pollution degree							

* Female connector block

** Male connector block

Card Holders

For inserting 19" rack cards in Euro format

- Convert IEC 603/DIN 41 612 and 41 617 plug-in connectors to LP connection elements
- Mechanical lever reliably releases and ejects card
- 19" inserts secured from the front
- Protective cover on rear side of card
- Mount direct in switchgear cabinet or on TS 35 mounting rail

SKH2 31
SKH2B 64

SKH2C 64 (a/c)
SKH2B 32

SKH2E 48
SKH2F 32 (z/b)

SKH2F 32 (z/d)
SKH2F 48

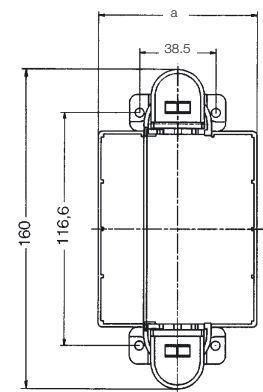
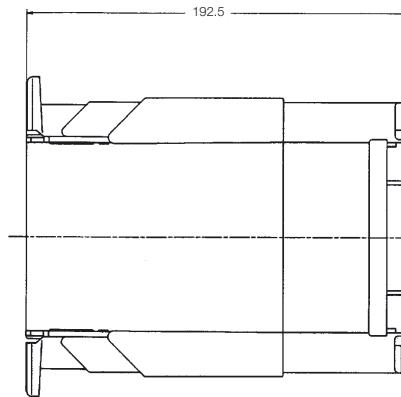
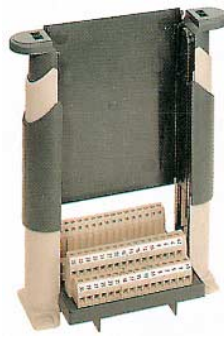

Ordering data	SKH2 31 SKH2B 64		SKH2C 64 (a/c) SKH2D 32		SKH2E 48 SKH2F 32 (z/b)		SKH2F 32 (z/d) SKH2F 48	
Cat. No.	8174800000	8174810000	8174820000	8174830000	8174840000	8174850000	8174860000	8174880000
Technical data	31-pole B 64		C 64 D 32		E 48 F 32		F 32 F 48	
Female connector block	DIN 41,617		DIN 41 612		DIN 41 612		DIN 41 612	
Plug-in connector	Screws		Screws		Screws		Screws	
Connection type	Screws		Screws		Screws		Screws	
Mechanical characteristics	Screws		Screws		Screws		Screws	
Dimensions	Max. permissible weight on card = 0.55 kg.							
Insulation stripping length	7 mm	7 mm	7 mm	7 mm	7 mm	7 mm	7 mm	7 mm
Terminal screw	M 2.5	M 2.5	M 2.5	M 2.5	M 2.5	M 2.5	M 2.5	M 2.5
Mounting width a	60.7 mm	80.7 mm	80.7 mm	55.0 mm	70.7 mm	80.7 mm	80.7 mm	80.7 mm
Clampable conductors								
Max. clamping range	0.13...2.5 mm ²		0.13...2.5 mm ²		0.13...2.5 mm ²		0.13...2.5 mm ²	
„e“ solid HO7V-U	0.5...2.5 mm ²		0.5...2.5 mm ²		0.5...2.5 mm ²		0.5...2.5 mm ²	
„f“ flexible HO7V-K	0.5...2.5 mm ²		0.5...2.5 mm ²		0.5...2.5 mm ²		0.5...2.5 mm ²	
„f“ with ferrules according to DIN 46228/1	0.5...1.5 mm ²		0.5...1.5 mm ²		0.5...1.5 mm ²		0.5...1.5 mm ²	
With plastic collar	0.5...1.5 mm ²		0.5...1.5 mm ²		0.5...1.5 mm ²		0.5...1.5 mm ²	
Conductor cross-section	AWG 26...14		AWG 26...14		AWG 26...14		AWG 26...14	
Plug gauge according to DIN/EN 50027	A1		A1		A1		A1	
Conversion connection terminal/plug-in connector	1 : 1		1 : 1		1 : 1		1 : 1	
Rated data								
Rated voltage	125 V~ 160 V~		160 V~ 250 V~		250 V~ 250 V~		250 V~ 250 V~	
Rated current	4 A 2 A		2 A 4 A		4 A 4 A		4 A 4 A	
Rated cross-section	1.5 mm ² 1.5 mm ²		1.5 mm ² 1.5 mm ²		1.5 mm ² 1.5 mm ²		1.5 mm ² 1.5 mm ²	
Test voltage	0.9 kV~eff 1.0 kV~eff		1.0 kV~eff 1.0 kV~eff		1.0 kV~eff 1.0 kV~eff		1.0 kV~eff 1.0 kV~eff	
Test torque	0.4 Nm 0.4 Nm		0.4 Nm 0.4 Nm		0.4 Nm 0.4 Nm		0.4 Nm 0.4 Nm	
Ambient temperature	0 °C...+55 °C		0 °C...+55 °C		0 °C...+55 °C		0 °C...+55 °C	
Storage temperature	-40 °C...+70 °C		-40 °C...+70 °C		-40 °C...+70 °C		-40 °C...+70 °C	
Insulation coordination according to EN 50 178								
Overvoltage category	III III		III III		III III		III III	
Pollution degree	2 2		2 2		2 2		2 2	
Accessories	Type Cat. No. Qty.		Type Cat. No. Qty.		Type Cat. No. Qty.		Type Cat. No. Qty.	
Assembly material for mounting on TS 35	SKH2/35 8209340000 1		SKH2/35 8209340000 1		SKH2/35 8209340000 1		SKH2/35 8209340000 1	
Mounting rail	TS 35 x 7.5 0383400000 -		TS 35 x 7.5 0383400000 -		TS 35 x 7.5 0383400000 -		TS 35 x 7.5 0383400000 -	
	TS 35 x 15 0498000000 -		TS 35 x 15 0498000000 -		TS 35 x 15 0498000000 -		TS 35 x 15 0498000000 -	

Card Holders

- For inserting cards in Euro and double Euro format
- Convert IEC 603/DIN 41 612 and 41 617 plug-in connectors to LP connection elements

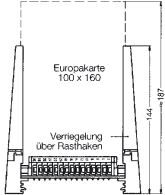

SKH 31
SKH 31 250 V

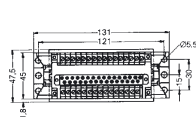

SKHB 64

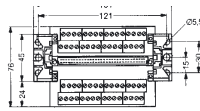

SKHC 64

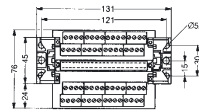

SKHD 32

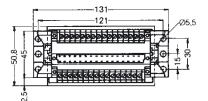

Ordering data	Type	Cat. No.	Qty.	Type	Cat. No.	Qty.	Type	Cat. No.	Qty.	Type	Cat. No.	Qty.	
	SKH 31	0586661001	1	SKHB 64	0577360000	1	SKHC 64	0178960000	1	SKHD 32	0586761001	1	
	SKH 31 250 V	0648661001	1				SKHC 64	0646660000	1				
							with 2 latch clips						
Technical data													
Female connector block	31-pole (i.a.w. DIN 41617)			B 64 (i.a.w. DIN 41612)			C 64 (i.a.w. DIN 41612)			D 32 (i.a.w. DIN 41612)			
Assembly	Screws			a and b			a and c			a and c			
Connection type	Screws			Screws			Screws			Screws			
Dimensions													
Insulation stripping length	7 mm			7 mm			7 mm			7 mm			
Terminal screw	M 2.5			M 2.5			M 2.5			M 2.5			
Clampable conductors													
Max. clamping range	0.13...4 mm ²			0.13...1.5 mm ²			0.13...1.5 mm ²			0.13...4 mm ²			
„e“ solid HO7V-U	0.5...4 mm ²			0.5...1.5 mm ²			0.5...1.5 mm ²			0.5...4 mm ²			
„f“ flexible HO7V-U	0.5...2.5 mm ²			0.5...1.5 mm ²			0.5...1.5 mm ²			0.5...2.5 mm ²			
„f“ with ferrules													
According to DIN 46228/1	0.5...2.5 mm ²			0.5...1.5 mm ²			0.5...1.5 mm ²			0.5...2.5 mm ²			
With plastic collar	0.5...2.5 mm ²			0.5...1.5 mm ²			0.5...1.5 mm ²			0.5...2.5 mm ²			
Conductor cross-section	AWG 26...14			AWG 26...16			AWG 26...16			AWG 26...14			
Conversion connection level/	1 : 1			1 : 1			1 : 1			1 : 1			
Plug-in connector													
Plug gauge according to DIN/EN 50027 Size	A3			A1			A1			A3			
Rated data													
Rated voltage	125 V~ (0586660000) 250 V~ (0648660000)			125 V~			125 V~			250 V~			
Rated current	5 A			2 A			2 A			6 A			
Rated cross-section	2.5 mm ²			1.5 mm ²			1.5 mm ²			2.5 mm ²			
Test voltage	1.25 kV~eff (0586660000) 1.5 kV~eff (0648660000)			0.5 kV~eff			0.5 kV~eff			2.0 kV~eff			
Test torque	0.4 Nm			0.4 Nm			0.4 Nm			0.4 Nm			
Ambient temperature	0 °C...+55 °C			0 °C...+55 °C			0 °C...+55 °C			0 °C...+55 °C			
Storage temperature	-40 °C...+70 °C			-40 °C...+70 °C			-40 °C...+70 °C			-40 °C...+70 °C			
Insulation coordination according to EN 50 178													
Overvoltage category	III			III			III			III			
Pollution degree	2			2			2			2			
Accessories	Type	Cat. No.	Qty.	Type	Cat. No.	Qty.	Type	Cat. No.	Qty.	Type	Cat. No.	Qty.	
Support plate	HP	0137100000	20	HP	0137100000	20	HP	0137100000	20	HP	0137100000	20	
(To increase mechanical stability. Included in range of supply).													
Grip	white	ZG	0128000000	-	ZG	0128000000	-	ZG	0128000000	-	ZG	0128000000	-
	black	ZG	0128060000	-	ZG	0128060000	-	ZG	0128060000	-	ZG	0128060000	-
Mounting foot for TS 35 (metal)	FM 4	0687900000	40	FM 4	0687900000	40	FM 4	0687900000	40	FM 4	0687900000	40	
Mounting bracket for mounting on TS 32	MB (M 3+M 5)	0503500000	100	MB (M 3+M 5)	0503500000	100	MB (M 3+M 5)	0503500000	100	MB (M 3+M 5)	0503500000	100	
	MB (M 4+M 6)	0334900000	20	MB (M 4+M 6)	0334900000	20	MB (M 4+M 6)	0334900000	20	MB (M 4+M 6)	0334900000	20	
Mounting plate	MP	2054280000	-	MP	2054280000	-	MP	2054280000	-	MP	2054280000	-	
Mounting rail	TS 32	0122800000	-	TS 32	0122800000	-	TS 32	0122800000	-	TS 32	0122800000	-	
	TS 35 x 7.5	0383400000	-	TS 35 x 7.5	0383400000	-	TS 35 x 7.5	0383400000	-	TS 35 x 7.5	0383400000	-	
	TS 35 x 15	0498000000	-	TS 35 x 15	0498000000	-	TS 35 x 15	0498000000	-	TS 35 x 15	0498000000	-	

Card Holders

- For inserting cards in Euro and double Euro format
- Convert IEC 603/DIN 41 612 and 41 617 plug-in connectors to LP connection elements

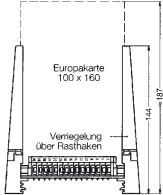

SKHD 32

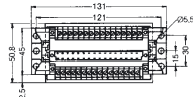

SKHE 48

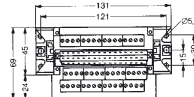

SKHF 32

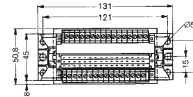

Ordering data

Type	Cat. No.	Qty.
SKHD 32	0107661001	1
With mounting foot		
on TS 35 horizontal		
SKHD 32	0106161001	1
With mounting foot		
on TS 35 vertical		

Technical data

Female connector block

Assembly	a and c
Connection type	Screws

Dimensions

Insulation stripping length	7 mm
Terminal screw	M 2.5

Clampable conductors

Max. clamping range	0.13...4 mm ²
„e“ solid HO7V-U	0.5...4 mm ²
„f“ flexible HO7V-U	0.5...2.5 mm ²
„f“ with ferrules	
according to DIN 46228/1	0.5...2.5 mm ²
With plastic collar	0.5...2.5 mm ²
Conductor cross-section	26...14 mm ²
Conversion connection level/	1 : 1
Plug-in connector	
Plug gauge according to DIN/EN 50027 Size	A3

Rated data

Rated voltage	380 V~
Rated current	6 A
Rated cross-section	2.5 mm ²
Test voltage	2.0 kV~eff
Test torque	0.4 Nm
Ambient temperature	0 °C...+55 °C
Storage temperature	-40 °C...+70 °C

Insulation coordination according to EN 50 178

Overvoltage category	III
Pollution degree	2

Accessories

Support plate (To increase mechanical stability. Included in range of supply).	HP	0137100000	20
Grip	ZG	0128000000	-
	ZG	0128060000	-
Mounting foot for TS 35 (metal)			
Mounting bracket for mounting on TS 32			
Mounting plate	MP	2054280000	-
Mounting rail	TS 32	0122800000	-
	TS 35 x 7,5	0383400000	-
	TS 35 x 15	0498000000	-

Ordering data

Type	Cat. No.	Qty.
SKHD 32	0107661001	1
With mounting foot		
on TS 35 horizontal		
SKHD 32	0106161001	1
With mounting foot		
on TS 35 vertical		

D 32 (i.a.w. DIN 41612)

Assembly	a and c
Connection type	Screws

Insulation stripping length	7 mm
Terminal screw	M 2.5

Max. clamping range	0.13...4 mm ²
„e“ solid HO7V-U	0.5...4 mm ²
„f“ flexible HO7V-U	0.5...2.5 mm ²
„f“ with ferrules	
according to DIN 46228/1	0.5...2.5 mm ²
With plastic collar	0.5...2.5 mm ²
Conductor cross-section	26...14 mm ²
Conversion connection level/	1 : 1
Plug-in connector	
Plug gauge according to DIN/EN 50027 Size	A3

Rated voltage	380 V~
Rated current	6 A
Rated cross-section	2.5 mm ²
Test voltage	2.0 kV~eff
Test torque	0.4 Nm
Ambient temperature	0 °C...+55 °C
Storage temperature	-40 °C...+70 °C

Overvoltage category	III
Pollution degree	2

Type	Cat. No.	Qty.
HP	0137100000	20

ZG	0128000000	-
ZG	0128060000	-

TS 32	0122800000	-
TS 35 x 7,5	0383400000	-
TS 35 x 15	0498000000	-

Ordering data

Type	Cat. No.	Qty.
SKHE 48	0690660000	1

E 48 (i.a.w. DIN 41612)

Assembly	e, c and a
Connection type	Screws

Insulation stripping length	7 mm
Terminal screw	M 2.5

Max. clamping range	0.13...1.5 mm ²
„e“ solid HO7V-U	0.5...1.5 mm ²
„f“ flexible HO7V-U	0.5...1.5 mm ²
„f“ with ferrules	
according to DIN 46228/1	0.5...1.5 mm ²
With plastic collar	0.5...1.5 mm ²
Conductor cross-section	AWG 26...16
Conversion connection level/	1 : 1
Plug-in connector	
Plug gauge according to DIN/EN 50027 Size	A1

Rated voltage	125 V~
Rated current	5 A
Rated cross-section	1.5 mm ²
Test voltage	1.25 kV~eff
Test torque	0.4 Nm
Ambient temperature	0 °C...+55 °C
Storage temperature	-40 °C...+70 °C

Overvoltage category	III
Pollution degree	2

Type	Cat. No.	Qty.
HP	0137100000	20

ZG	0128000000	-
ZG	0128060000	-

TS 32	0122800000	-
TS 35 x 7,5	0383400000	-
TS 35 x 15	0498000000	-

Ordering data

Type	Cat. No.	Qty.
SKHF 32 (z/b)	0586861001	1
SKHF 32 (z/d)	0586961001	1

F 32 (i.a.w. DIN 41612)

Assembly	z and b (0586860000) /z and d (0586960000)
Connection type	Screws

Insulation stripping length	7 mm
Terminal screw	M 2.5

Max. clamping range	0.13...4 mm ²
„e“ solid HO7V-U	0.5...4 mm ²
„f“ flexible HO7V-U	0.5...2.5 mm ²
„f“ with ferrules	
according to DIN 46228/1	0.5...2.5 mm ²
With plastic collar	0.5...2.5 mm ²
Conductor cross-section	AWG 26...14
Conversion connection level/	1 : 1
Plug-in connector	
Plug gauge according to DIN/EN 50027 Size	A3

Rated voltage	250 V~
Rated current	6 A
Rated cross-section	2.5 mm ²
Test voltage	1.25 kV~eff
Test torque	0.4 Nm
Ambient temperature	0 °C...+55 °C
Storage temperature	-40 °C...+70 °C

Overvoltage category	III
Pollution degree	2

Type	Cat. No.	Qty.
HP	0137100000	20

ZG	0128000000	-
ZG	0128060000	-

TS 32	0122800000	-
TS 35 x 7,5	0383400000	-
TS 35 x 15	0498000000	-

Card Holders

- For inserting cards in Euro and double Euro format
- Convert IEC 603/DIN 41 612 and 41 617 plug-in connectors to LP connection elements

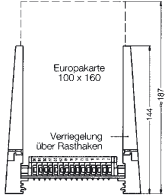

SKHF 48

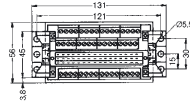

SKHH 15



**SKHE 48x2
SKHF 48x2
SKHC 64x2
SKHD 32x2**

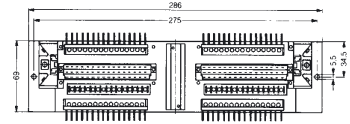
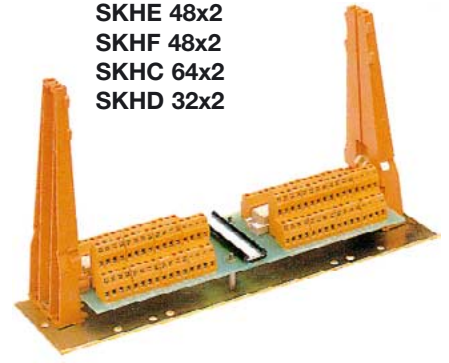

Ordering data

Type Cat. No. Qty.

SKHF 48	0587060000	1

Type Cat. No. Qty.

SKHH 15	8051300000	1

Type Cat. No. Qty.

SKHE 48 x 2	0645760000	1
SKHF 48 x 2	8009260000	1
SKHC 64 x 2	8013120000	1
SKHD 32 x 2	8050981001	1

Technical data

Female connector block
 Assembly
 Connection type

F 48 (i.a.w. DIN 41612)
 z, b and d
 Screws

H 15 (i.a.w. DIN 41612)
 a and c
 Screws

For double Euro cards 233 x 160 mm (i.a.w. DIN 41612)
 Screws (S)

Dimensions

Insulation stripping length
 Terminal screw

7 mm
 M 2.5

7 mm
 M 2.5

7 mm
 M 2.5

Clampable conductors

Max. clamping range
 „e“ solid HO7V-U
 „f“ flexible HO7V-U
 „f“ with ferrules
 According to DIN 46228/1
 With plastic collar
 Conductor cross-section
 Conversion connection level/
 Plug-in connector
 Plug gauge according to DIN/EN 50027 Size

0.13...1.5 mm²
 0.5...1.5 mm²
 0.5...1.5 mm²
 0.5...1.5 mm²
 0.5...1.5 mm²
 AWG 26...16
 1 : 1
 A1

0.13...1.5 mm²
 0.5...1.5 mm²
 0.5...1.5 mm²
 0.5...1.5 mm²
 0.5...1.5 mm²
 AWG 26...16
 1 : 1
 A1

0.13...1.5 mm²
 0.5...1.5 mm²
 0.5...1.5 mm²
 0.5...1.5 mm²
 0.5...1.5 mm²
 AWG 26...16
 1 : 1
 A1

Rated data

Rated voltage
 Rated current
 Rated cross-section
 Test voltage
 Test torque
 Ambient temperature
 Storage temperature

125 V~
 5 A
 1.5 mm²
 1.25 kV~eff
 0.4 Nm
 0 °C...+55 °C
 -40 °C...+70 °C

250 V~
 10 A
 2.5 mm²
 2.0 kV~eff
 0.4 Nm
 0 °C...+55 °C
 -40 °C...+70 °C

125 V~
 5 A
 1.5 mm²
 1.25 kV~eff
 0.4 Nm
 0 °C...+55 °C
 -40 °C...+70 °C

Insulation coordination according to EN 50 178

Overvoltage category
 Pollution degree

III
 2

III
 2

III
 2

Accessories

Support plate
 (To increase mechanical stability. Included in range of supply).

Type Cat. No. Qty.
 HP **0137100000** 20

Type Cat. No. Qty.
 HP **0137100000** 20

Type Cat. No. Qty.
 HP **0136800000** 20

Grip	white	
	black	
Mounting foot for TS 35 (metal)	ZG	0128060000 -
Mounting bracket for mounting on TS 32	FM 4	0687900000 40
Mounting plate	MB (M 3+M 5)	0503500000 100
	MB (M 4+M 6)	0334900000 20
	MP (Euro card)	2054280000 -
Mounting rail	TS 32	0122800000 -
	TS 35 x 7,5	0383400000 -
	TS 35 x 15	0498000000 -

ZG	0128000000	-
ZG	0128060000	-
FM 4	0687900000	40
MB (M 3+M 5)	0503500000	100
MB (M 4+M 6)	0334900000	20
MP (Euro card)	2054280000	-
TS 32	0122800000	-
TS 35 x 7,5	0383400000	-
TS 35 x 15	0498000000	-

ZG	0128000000	-
ZG	0128060000	-
FM 4	0687900000	40
MB (M 3+M 5)	0503500000	100
MB (M 4+M 6)	0334900000	20
MP (Euro card)	2054280000	-
TS 32	0122800000	-
TS 35 x 7,5	0383400000	-
TS 35 x 15	0498000000	-

ZG	0128000000	-
ZG	0128060000	-
FM 4	0687900000	40
MB (M 3+M 5)	0503500000	100
MB (M 4+M 6)	0334900000	20
MP (double Euro card)	2051430000	-
TS 32	0122800000	-
TS 35 x 7,5	0383400000	-
TS 35 x 15	0498000000	-