

## 阅读申明

- 1.本站收集的数据手册和产品资料都来自互联网，版权归原作者所有。如读者和版权方有任何异议请及时告之，我们将妥善解决。
- 2.本站提供的中文数据手册是英文数据手册的中文翻译，其目的是协助用户阅读，该译文无法自动跟随原稿更新，同时也可能存在翻译上的不当。建议读者以英文原稿为参考以便获得更精准的信息。
- 3.本站提供的产品资料，来自厂商的技术支持或者使用者的心得体会等，其内容可能存在描述上的差异，建议读者做出适当判断。
- 4.如需与我们联系，请发邮件到marketing@iczoom.com，主题请标有“数据手册”字样。

## Read Statement

1. The datasheets and other product information on the site are all from network reference or other public materials, and the copyright belongs to the original author and original published source. If readers and copyright owners have any objections, please contact us and we will deal with it in a timely manner.
2. The Chinese datasheets provided on the website is a Chinese translation of the English datasheets. Its purpose is for reader's learning exchange only and do not involve commercial purposes. The translation cannot be automatically updated with the original manuscript, and there may also be improper translations. Readers are advised to use the English manuscript as a reference for more accurate information.
3. All product information provided on the website refer to solutions from manufacturers' technical support or users the contents may have differences in description, and readers are advised to take the original article as the standard.
4. If you have any questions, please contact us at marketing@iczoom.com and mark the subject with "Datasheets" .

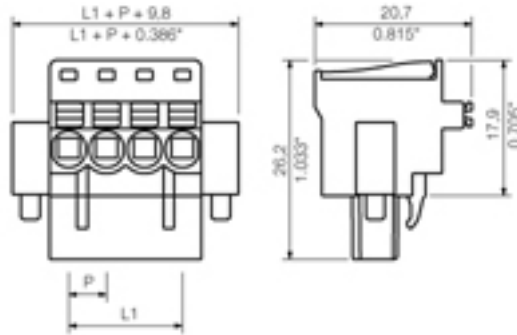

#### General ordering data

Order No.	1980660000
Part designation	BLF 5.00/04/90F SN OR BX
Version	PCB plug-in connector, PUSH IN, Clamping range, max.: 3.31 mm <sup>2</sup> , Pitch in mm: 5 mm, No. of poles: 4, 90°, Box
EAN	4032248675814
Qty.	60 pc(s).
Packaging	Box

#### System parameters

Conductor connection system	PUSH IN
Outgoing direction of conductor	90°
Pitch in mm	5 mm
Pitch in inch	0.197 inch
No. of poles	4
No. of rows	1
Screwdriver blade	0.6 x 3.5
Screwdriver blade standard	DIN 5264
Stripping length	10 mm
L1 in mm	15 mm
L1 in inch	0.591 inch
Electric shock protection to DIN VDE 0470	IP 20
Electric shock protection to DIN VDE 57 106	Safe from finger touch

#### Material data

Insulating material	PBT
Colour	Orange
colour chart	Similar to RAL 2000
Flammability class UL 94	V-0
Contact material	CuSn
Contact surface	tinned
Contact base material	CuSn

#### Connectable conductors

Clamping range, min.	0.13 mm <sup>2</sup>
Clamping range, max.	3.31 mm <sup>2</sup>
Conductor connection cross-section AWG, min.	AWG 26
Conductor connection cross-section AWG, max.	AWG 12
Solid, min. H05(07) V-U	0.2 mm <sup>2</sup>
Solid, max. H05(07) V-U	2.5 mm <sup>2</sup>
Stranded, max. H07V-R	2 mm <sup>2</sup>
Stranded, min. H07V-R	0 mm <sup>2</sup>
Flexible, min. H05(07) V-K	0.2 mm <sup>2</sup>
Flexible, max. H05(07) V-K	2.5 mm <sup>2</sup>
w. wire end ferrule, DIN 46228 pt 1, min	0.2 mm <sup>2</sup>
with wire end ferrule, DIN 46228 pt 1, max.	2.5 mm <sup>2</sup>
w. plastic collar ferrule, DIN 46228 pt 4, min.	0.2 mm <sup>2</sup>
with plastic collar ferrule, DIN 46228 pt 4, max.	2.5 mm <sup>2</sup>
Gauge to EN 60999 a x b; ø	2.4 mm x 1.5 mm

#### DIN IEC rating data

Rated current, min. No. of poles (Tu=20°C)	18.5 A
Rated current, max. No. of poles (Tu=20°C)	6 A
Rated current, no. of poles (Tu=40°C), min.	12.5 A
Rated current, no. of poles (Tu=40°C), max.	6 A
Rated voltage for overvoltage class/pollution severity II/2	400 V
Rated voltage for overvoltage class/pollution severity III/2	320 V
Rated voltage at overvoltage category/pollution degree III/3	250 V
Rated impulse withstand voltage for overvoltage class/pollution severity II/2	4 kV
Rated impulse withstand voltage for overvoltage class/pollution severity III/2	4 kV
Rated impulse withstand voltage for overvoltage class/pollution severity III/3	4 kV
Short-time withstand current resistance	3 x 1s with 120 A

#### CSA rating data

Rated voltage (Use group B)	300 V
Rated current (use group B)	10 A

#### UL 1059 rating data

Rated voltage (use group B)	300 V
Rated current (use group B)	10 A

#### Approvals

Approvals institutes	CSA; CURUS
----------------------	------------

#### Classifications

eClass 6.0	27-26-07-08
------------	-------------

#### Notes

Notes

Notes

Similar products

Order No.	Part designation	Version
1979460000	BLF 5.00/02/90F SN BK BX	PCB plug-in connector, PUSH IN, Clamping range, max.: 3.31 mm <sup>2</sup> , Pitch in mm: 5 mm, No. of poles: 2, 90°, Box
1979470000	BLF 5.00/03/90F SN BK BX	PCB plug-in connector, PUSH IN, Clamping range, max.: 3.31 mm <sup>2</sup> , Pitch in mm: 5 mm, No. of poles: 3, 90°, Box
1979480000	BLF 5.00/04/90F SN BK BX	PCB plug-in connector, PUSH IN, Clamping range, max.: 3.31 mm <sup>2</sup> , Pitch in mm: 5 mm, No. of poles: 4, 90°, Box
1979490000	BLF 5.00/05/90F SN BK BX	PCB plug-in connector, PUSH IN, Clamping range, max.: 3.31 mm <sup>2</sup> , Pitch in mm: 5 mm, No. of poles: 5, 90°, Box
1979500000	BLF 5.00/06/90F SN BK BX	PCB plug-in connector, PUSH IN, Clamping range, max.: 3.31 mm <sup>2</sup> , Pitch in mm: 5 mm, No. of poles: 6, 90°, Box
1979510000	BLF 5.00/07/90F SN BK BX	PCB plug-in connector, PUSH IN, Clamping range, max.: 3.31 mm <sup>2</sup> , Pitch in mm: 5 mm, No. of poles: 7, 90°, Box
1979520000	BLF 5.00/08/90F SN BK BX	PCB plug-in connector, PUSH IN, Clamping range, max.: 3.31 mm <sup>2</sup> , Pitch in mm: 5 mm, No. of poles: 8, 90°, Box
1979530000	BLF 5.00/09/90F SN BK BX	PCB plug-in connector, PUSH IN, Clamping range, max.: 3.31 mm <sup>2</sup> , Pitch in mm: 5 mm, No. of poles: 9, 90°, Box
1979540000	BLF 5.00/10/90F SN BK BX	PCB plug-in connector, PUSH IN, Clamping range, max.: 3.31 mm <sup>2</sup> , Pitch in mm: 5 mm, No. of poles: 10, 90°, Box
1979550000	BLF 5.00/11/90F SN BK BX	PCB plug-in connector, PUSH IN, Clamping range, max.: 3.31 mm <sup>2</sup> , Pitch in mm: 5 mm, No. of poles: 11, 90°, Box
1979560000	BLF 5.00/12/90F SN BK BX	PCB plug-in connector, PUSH IN, Clamping range, max.: 3.31 mm <sup>2</sup> , Pitch in mm: 5 mm, No. of poles: 12, 90°, Box
1979570000	BLF 5.00/13/90F SN BK BX	PCB plug-in connector, PUSH IN, Clamping range, max.: 3.31 mm <sup>2</sup> , Pitch in mm: 5 mm, No. of poles: 13, 90°, Box
1979580000	BLF 5.00/14/90F SN BK BX	PCB plug-in connector, PUSH IN, Clamping range, max.: 3.31 mm <sup>2</sup> , Pitch in mm: 5 mm, No. of poles: 14, 90°, Box
1979590000	BLF 5.00/15/90F SN BK BX	PCB plug-in connector, PUSH IN, Clamping range, max.: 3.31 mm <sup>2</sup> , Pitch in mm: 5 mm, No. of poles: 15, 90°, Box
1979600000	BLF 5.00/16/90F SN BK BX	PCB plug-in connector, PUSH IN, Clamping range, max.: 3.31 mm <sup>2</sup> , Pitch in mm: 5 mm, No. of poles: 16, 90°, Box
1979610000	BLF 5.00/17/90F SN BK BX	PCB plug-in connector, PUSH IN, Clamping range, max.: 3.31 mm <sup>2</sup> , Pitch in mm: 5 mm, No. of poles: 17, 90°, Box
1979620000	BLF 5.00/18/90F SN BK BX	PCB plug-in connector, PUSH IN, Clamping range, max.: 3.31 mm <sup>2</sup> , Pitch in mm: 5 mm, No. of poles: 18, 90°, Box
1979630000	BLF 5.00/19/90F SN BK BX	PCB plug-in connector, PUSH IN, Clamping range, max.: 3.31 mm <sup>2</sup> , Pitch in mm: 5 mm, No. of poles: 19, 90°, Box
1979640000	BLF 5.00/20/90F SN BK BX	PCB plug-in connector, PUSH IN, Clamping range, max.: 3.31 mm <sup>2</sup> , Pitch in mm: 5 mm, No. of poles: 20, 90°, Box