

## 阅读申明

- 1.本站收集的数据手册和产品资料都来自互联网，版权归原作者所有。如读者和版权方有任何异议请及时告之，我们将妥善解决。
- 2.本站提供的中文数据手册是英文数据手册的中文翻译，其目的是协助用户阅读，该译文无法自动跟随原稿更新，同时也可能存在翻译上的不当。建议读者以英文原稿为参考以便获得更精准的信息。
- 3.本站提供的产品资料，来自厂商的技术支持或者使用者的心得体会等，其内容可能存在描述上的差异，建议读者做出适当判断。
- 4.如需与我们联系，请发邮件到marketing@iczoom.com，主题请标有“数据手册”字样。

## Read Statement

1. The datasheets and other product information on the site are all from network reference or other public materials, and the copyright belongs to the original author and original published source. If readers and copyright owners have any objections, please contact us and we will deal with it in a timely manner.
2. The Chinese datasheets provided on the website is a Chinese translation of the English datasheets. Its purpose is for reader's learning exchange only and do not involve commercial purposes. The translation cannot be automatically updated with the original manuscript, and there may also be improper translations. Readers are advised to use the English manuscript as a reference for more accurate information.
3. All product information provided on the website refer to solutions from manufacturers' technical support or users the contents may have differences in description, and readers are advised to take the original article as the standard.
4. If you have any questions, please contact us at marketing@iczoom.com and mark the subject with "Datasheets" .

PANDUIT PART NUMBER	STUD SIZE	DIMENSIONS in.				
		A $\pm .040$	W $\pm .010$	C $\pm .015$	M $\pm .040$	H $\pm .010$
PN10-5SLF	#5	.86 (21.84)	.25 (6.35)	.22 (5.59)	.75 (19.05)	.12 (3.05)
PN10-6SLF	#6	.86 (21.84)	.25 (6.35)	.22 (5.59)	.75 (19.05)	.14 (3.56)
PN10-8SLF	#8	.92 (23.37)	.29 (7.37)	.26 (6.60)	.79 (20.07)	.16 (4.06)
PN10-10SLF	#10	.92 (23.37)	.33 (8.38)	.26 (6.60)	.79 (20.07)	.19 (4.83)
PN10-14SLF	1/4"	1.01 (25.65)	.45 (11.43)	.33 (8.38)	.85 (21.59)	.25 (6.35)

NOTES:

- UL LISTED AND CSA CERTIFIED FOR:
  - 300V. MAX. VOLTAGE RATING
  - #12-10 AWG STRANDED COPPER WIRE
  - 221° F (105° C) MAX. TEMP. RATING
- MATERIAL:
  - STAMPING - .04" (1.02) THK COPPER, TIN PLATED
  - HOUSING - NYLON, YELLOW
  - SLEEVE - BRASS, TIN PLATED
- PACKAGE QTY: STD. PKG. 50  
BULK PKG. 500
- DIMENSIONS IN BRACKETS ARE IN MILLIMETERS
- INSTALLATION TOOLS:
  - UL LISTED AND CSA CERTIFIED: CT-550, CT-1550 & CT-1551

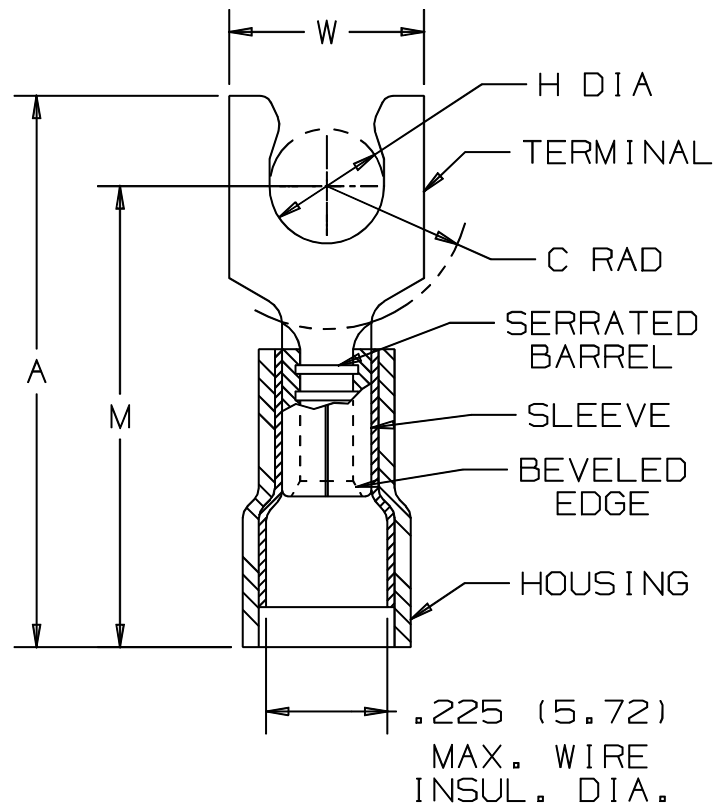

LISTED  
587H  
E52164



CERTIFIED  
LR3122

A41250\_05

05	1/01	KMD		CAD FILE SPEC. WAS N41250AA_PCD_04			
04	5/99	ED		UPDATED "A"&"M" DIM.S, AND MODIFIED DIMENSIONAL TOLERANCES			
	----	----		FILESPEC WAS: A41250_03 -----			
03	4/99	JKD	SKB	ADDED CT-1550 & CT-1551 TO NOTE 5	07581	JCJ	CTN
REV	DATE	BY	CHK	DESCRIPTION	ECN	APP	PM

**PANDUIT**

CORP.

TINLEY PARK, ILLINOIS

#12-10 BARREL NYLON INSULATED SHORT LOCKING FORK, .225 (5.72) MAX WIRE INSULATION DIAMETER

DRAWN BY DAW	CHK'D CJH	SCALE NONE	DRAWING NO. A41250
-----------------	--------------	---------------	-----------------------