

阅读申明

- 1.本站收集的数据手册和产品资料都来自互联网，版权归原作者所有。如读者和版权方有任何异议请及时告之，我们将妥善解决。
- 2.本站提供的中文数据手册是英文数据手册的中文翻译，其目的是协助用户阅读，该译文无法自动跟随原稿更新，同时也可能存在翻译上的不当。建议读者以英文原稿为参考以便获得更精准的信息。
- 3.本站提供的产品资料，来自厂商的技术支持或者使用者的心得体会等，其内容可能存在描述上的差异，建议读者做出适当判断。
- 4.如需与我们联系，请发邮件到marketing@iczoom.com，主题请标有“数据手册”字样。

Read Statement

1. The datasheets and other product information on the site are all from network reference or other public materials, and the copyright belongs to the original author and original published source. If readers and copyright owners have any objections, please contact us and we will deal with it in a timely manner.
2. The Chinese datasheets provided on the website is a Chinese translation of the English datasheets. Its purpose is for reader's learning exchange only and do not involve commercial purposes. The translation cannot be automatically updated with the original manuscript, and there may also be improper translations. Readers are advised to use the English manuscript as a reference for more accurate information.
3. All product information provided on the website refer to solutions from manufacturers' technical support or users the contents may have differences in description, and readers are advised to take the original article as the standard.
4. If you have any questions, please contact us at marketing@iczoom.com and mark the subject with "Datasheets" .

Specification

Drawing No.	KB101-12304-431 1/12
Issued Date.	JUN.29, 2012

TO: Digi-Key

Note: In case of specification change, KYOCERA Part Number also will be changed.

Product Name	Quartz Crystal
Product Model	CX3225CA
Frequency	per KB101-12304-431 3/12
Customer Part Number	-
Customer Specification Number	-
KYOCERA Part Number	per KB101-12304-431 3/12
Remarks	RoHS Compliant, MSL 1, AEC-Q200 compliant





Confirmation of stable oscillation of a crystal oscillation circuit is necessary at the design stage to prevent critical failures for automotive crystal units which are used to control vehicles and secure safety. It is strongly recommended to provide us a test circuit board and let us implement the circuit verification upon your use of our automotive crystal units.

Customer Acceptance

Accept Signature	Approved Date	
	Department	
	Person in charge	

Seller
KYOCERA Corporation
 (Electronic Components Sales Division)
 6 Takeda Tobadono-cho, Fushimi-ku, Kyoto
 612-8501 Japan
 TEL. No. 075-604-3500
 FAX. No. 075-604-3501

Manufacturer
KYOCERA Crystal Device Corporation
 (Marketing & Sales Engineering Division)
 1-8-1, Izumi-hontyo, Komae-shi, Tokyo
 201-8648 Japan
 TEL. No. 03-5497-3111
 FAX. No. 03-5497-3209

Design Department	Quality Assurance	Approved by	Checked by	Issued by
KYOCERA Crystal Device Yamagata Corporation Crystal Units Overseas Design Section Crystal Units Division 1				

Revision History

Rev.No.	Description of revise	Date	Approved by	Checked by	Issued by
1	First Edition	JUN.29,2012			

[PART NUMBER LIST]

Nominal Frequency (MHz)	Part number	ESR (Ω)	Nominal Frequency Code
9.84375	CX3225CA09843D0HSSZ1	500	9843
10	CX3225CA10000D0HSSZ1	500	10000
12	CX3225CA12000D0HSSZ1	300	12000
13.56	CX3225CA13560D0HSSZ1	300	13560
16	CX3225CA16000D0HSSZ1	100	16000
20	CX3225CA20000D0HSSZ1	100	20000
24	CX3225CA24000D0HSSZ1	100	24000
25	CX3225CA25000D0HSSZ1	100	25000
26	CX3225CA26000D0HSSZ1	100	26000
27	CX3225CA27000D0HSSZ1	100	27000
28.63636	CX3225CA28636D0HSSZ1	100	28636
30	CX3225CA30000D0HSSZ1	100	30000
32	CX3225CA32000D0HSSZ1	100	32000
40	CX3225CA40000D0HSSZ1	100	40000

1. APPLICATION

This specification sheet is applied to quartz crystal "CX3225CA"

2. KYOCERA PART NUMBER

per KB101-12304-431 3/12

3. RATINGS

Items	SYMB.	Rating	Unit	Remarks
Operating Temperature	Topr	-40~+125	°C	
Storage Temperature Range	Tstg	-40~+150	°C	

4. CHARACTERISTICS**4-1 ELECTRICAL CHARACTERISTICS**

Items	Electrical Specification					Test Condition	Remarks
	SYMB.	Min.	Typ.	Max.	Unit		
Mode of Vibration		Fundamental					
Nominal Frequency	F0		※		MHz		
Nominal Temperature	T _{NOM}		25		°C		
Load Capacitance	CL		8.0		pF		
Frequency Tolerance	df/F	-20.0		+20.0	PPM	+25 ±3°C	
Frequency Temperature Characteristics	df/F	-50.0		+50.0		-40~+125°C	
Frequency Aging Rate		-5.0		+5.0		1 year	+25 ±3°C
Equivalent Series Resistance	ESR			※	Ω		
Drive Level	Pd	0.01		200	μW		
Insulation Resistance	IR	500			MΩ	100V(DC)	

※ per KB101-12304-431 3/12

5. APPEARANCES, PHYSICAL DIMENSION
OUTLINE DIMENSION (not to scale)

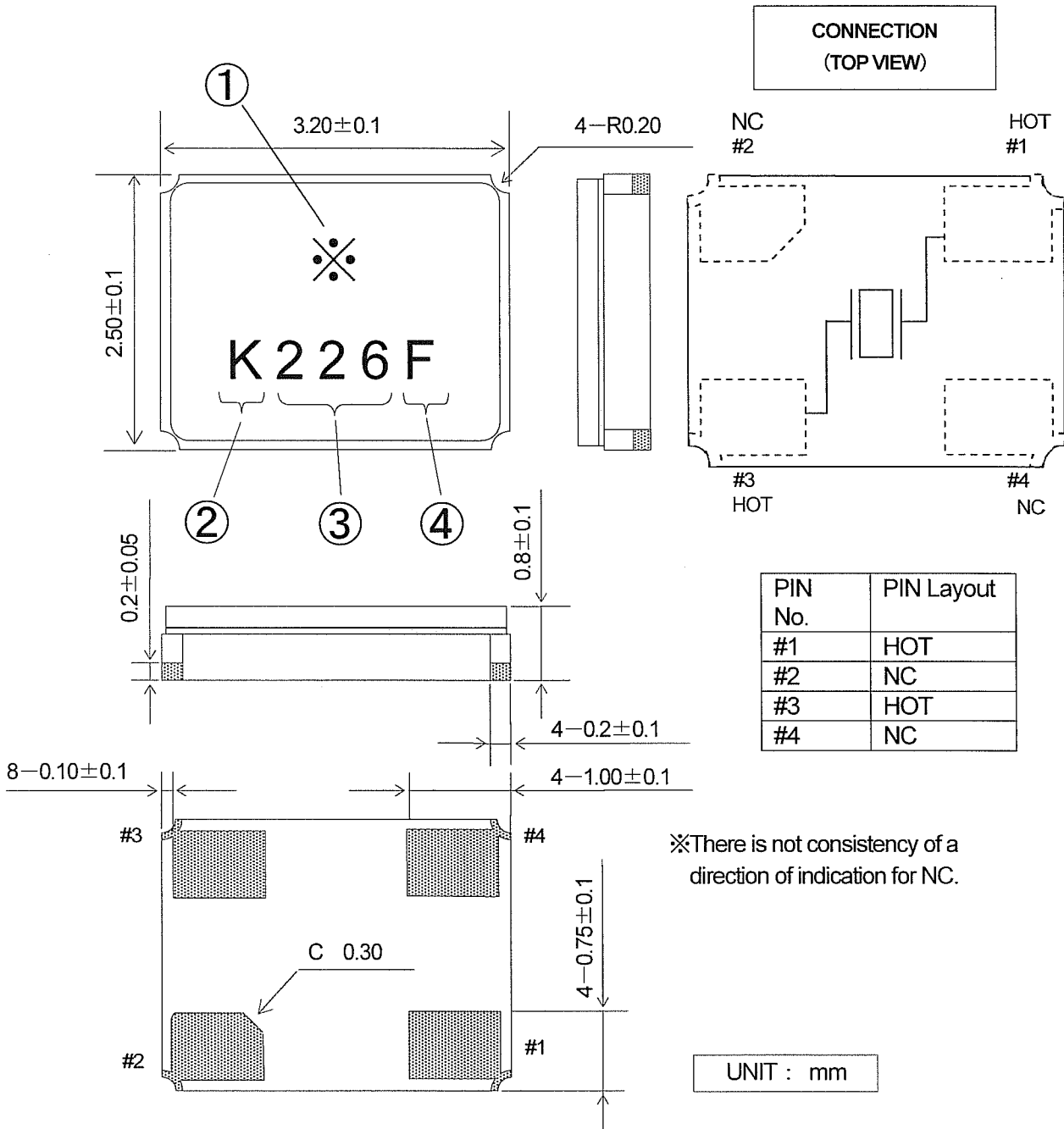

※There is not consistency of a direction of indication for NC.

MARKING

① Nominal Frequency

Move the number of maximum indication beams of the frequency to five digits, and omit less than kHz.

※ per KB101-12304-431 3/12

② Identification

③ Date Code

Year···LAST 1 DIGIT of YEAR AND WEEK

※ For details to LOT CALENDAR

(Ex) JUN.29, 2012 → 226

④ Manufacturing Location F···KYOCERA Crystal Device Philippines, Inc

※The font of marking is reference.

6. RECOMMENDED LAND PATTERN (not to scale)

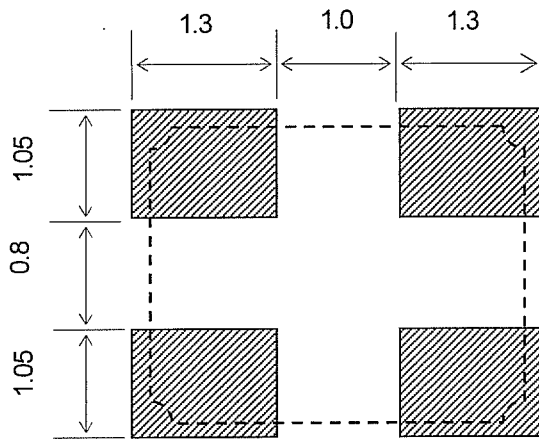

UNIT : mm

7. Quality Assurance

Location

KYOCERA Crystal Device Philippines, Inc. : KYOCERA Crystal Device Philippines, Inc.

Quality Assurance Division

Quality guarantee

When the failure by the responsibility of our company occurs clearly after delivery within 1 year, a substitute article etc. is appropriated gratuitously and this is guaranteed. However, when passing 1 year after delivery, there is a case where I am allowed to consider as onerous repair after both consultation.

8.TAPING & REEL

8-1.Dimensions

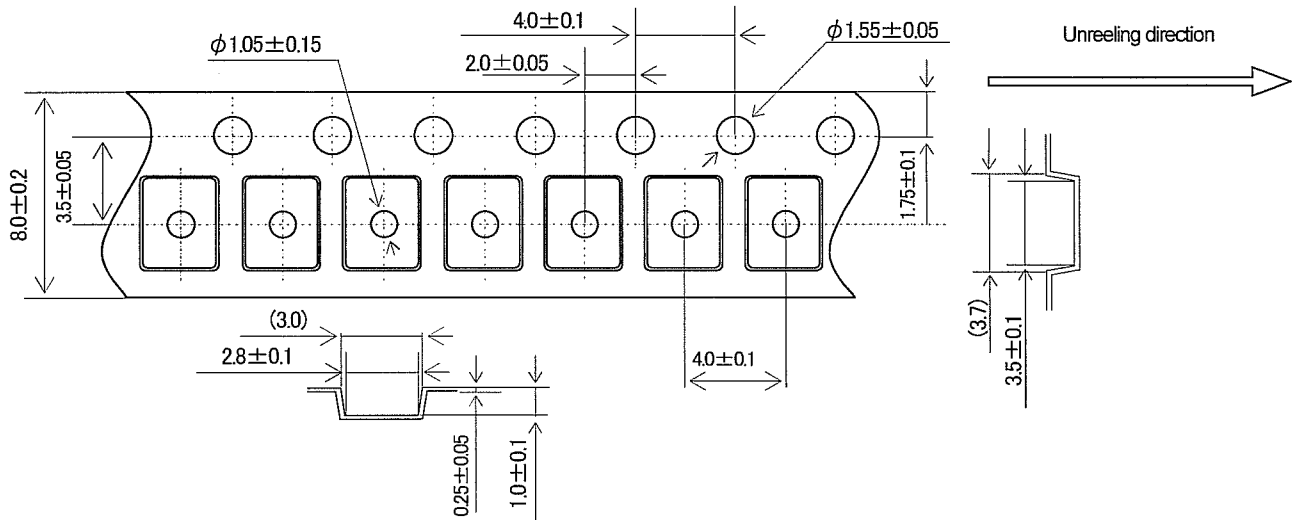

8-2.Leader and trailer tape

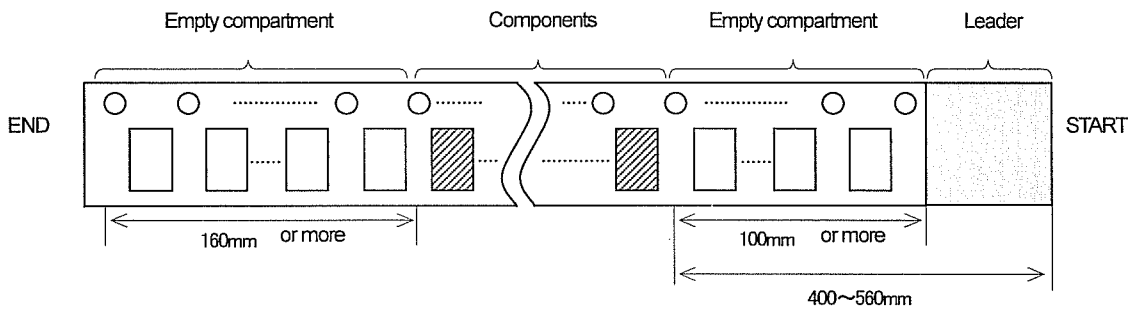

8-3.Direction (The direction shall be seen from the top cover tape side)

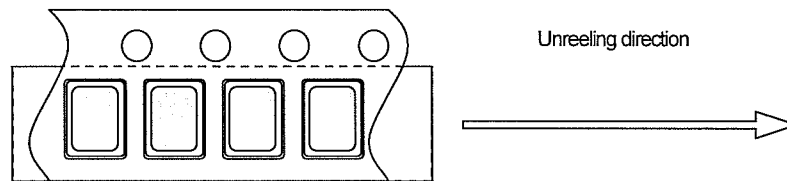

8-4.Specification

1. Material of the carrier tape shall be PS (ESD).
2. Material of the seal tape shall be polyester(ESD).
3. The seal tape shall not cover the sprocket holes. And not protrude from the carrier tape.
4. Tensile strength of the tape : 10N or more.
5. The R of the corner without designation is 0.2RMAX.
6. Disalignment between centers of the cavity and sprocket hole shall be 0.05mm or less.
7. Cumulative pitch tolerance of "P₀" shall be ± 0.2 mm at 10 pitches.
8. The number of lack is 0.1% of 1 reel total part number (the number of the table letters) or the part following whose 1 either is big.
(But, the thing which lack of the continuance is not in.)
9. The marking on parts is not fixed its direction, its electrical characteristic is equal.
10. Peeling force of the seal tape: 0.1 to 1.0N.

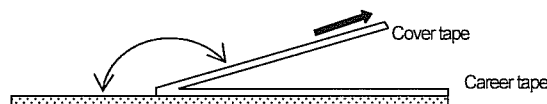

8-5.Reel specifications

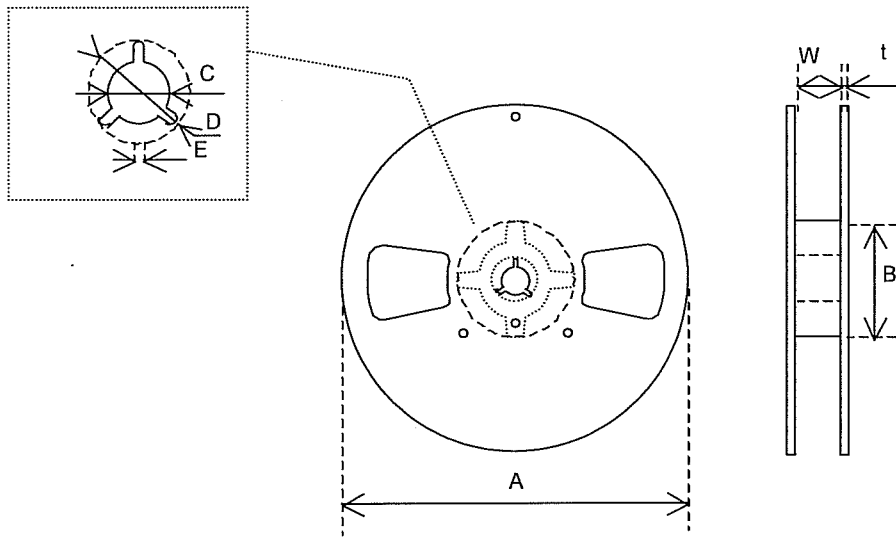

(Nonconductor type Reel)

In the case of $\Phi 180$ Reel (3000 pcs max)

	A	B	C	D
Dimension	$\phi 180 +0/-1.5$	$\phi 60 +1/-0$	$\phi 13 \pm 0.2$	$\phi 21 \pm 0.8$
Symbol	E	W	t	
Dimension	2.0 ± 0.5	9 ± 1	2.0 ± 0.5	

(Unit : mm)

9. Environmental requirements

After following test, frequency shall not change more than $\pm 10 \times 10^{-6}$

And CI, $\pm 20\%$ or 5Ω of large value.

9.1 Resistance to Shock

Test condition

Natural dropped from height 100cm onto hard wood board in 3 times

9.2 Resistance to Vibration

Test condition

frequency : 10—55 —10 Hz
Amplitude : 1.5mm
Cycle time : 15 minutes
Direction : X,Y,Z (3direction), 2 h each.

9.3 Resistance to Heat

Test condition

The quartz crystal unit shall be stored at a temperature of $+150 \pm 2^\circ\text{C}$ for 500 h.
Then it shall be subjected to standard atmospheric conditions for 1 h, after which measurement shall be made.

9.4 Resistance to Cold

Test condition

The quartz crystal unit shall be stored at a temperature of $-40 \pm 2^\circ\text{C}$ for 500 h.
Then it shall be subjected to standard atmospheric conditions for 1 h, after which measurement shall be made.

9.5 Thermal Shock

Test condition

The quartz crystal unit shall be subjected to 500 successive change of temperature cycles, each as shown in table below, Then it shall be subjected to standard atmospheric conditions for 1h, after which measurements shall be made.

Cycle : $-40 \pm 2^\circ\text{C}$ (30min.) $\sim 25 \pm 2^\circ\text{C}$ (5min.)
 $\sim +150 \pm 2^\circ\text{C}$ (30min.) $\sim 25 \pm 2^\circ\text{C}$ (5min.)

9.6 Resistance to Moisture

Test condition

The quartz crystal unit shall be stored at a temperature of $60 \pm 2^\circ\text{C}$ with relative humidity of 90% to 95% for 240 h. Then it shall be subjected to standard atmospheric conditions for 1h, after which measurements shall be made

9.7 Soldering condition

1) Material of solder

Kind ... lead free solder paste
 Melting point ... $220 \pm 5^\circ\text{C}$

2) Temp.profile of reflow soldering system

	Temp [$^\circ\text{C}$]	Time[sec]
Peak	260 ± 5	10 (max.)
Preheating	180 (typ.)	100 (typ.)
Total	—	200 (max.)

Temp. profile of reflow

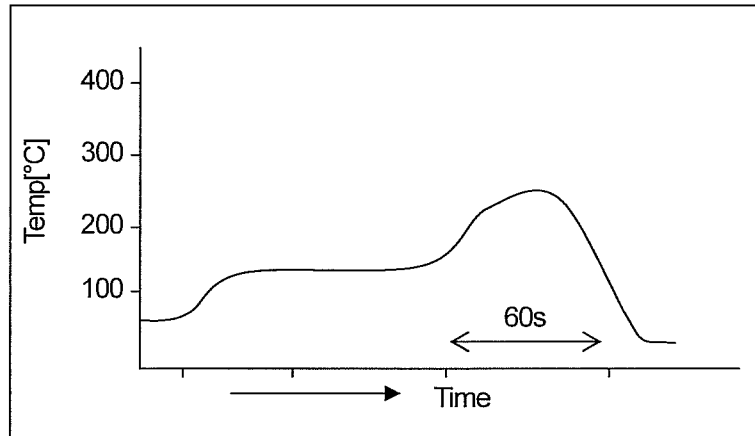

3) Hand Soldering Temperature: 350°C , Time: 3sec

9.8 Intensity for bending in circuit board

Solder this product in center of the circuit board of $40\text{mm} \times 100\text{mm}$, and add the deflection of 3mm as the bottom figure.

Test board : $t=1.6\text{mm}$

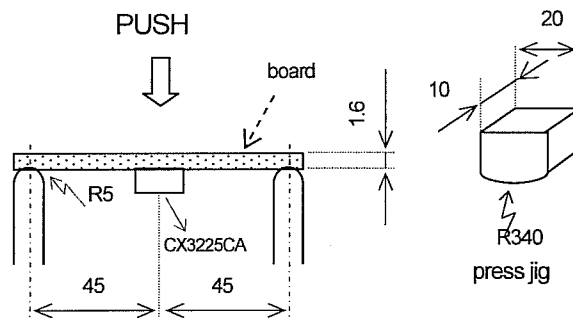

UNIT : mm

10. Cautions for use

(1) Automatic mounting machine use

Please use after affirmation that select the mounting machine model with a shock small if possible in the case of use of an automatic mounting machine, and it does not have breakage. There is a risk of a quartz crystal unit breakage occurring and not functioning normally by too much shock etc..

(2) Conformity of a circuit

In case of use of an oscillation circuit, please insert in a quartz crystal unit in series resistance 5 time as many as the standard value of equivalent in-series resistance, and confirm oscillating. Please remove resistance which inserted after the notes above-mentioned examination in the quartz crystal unit in series, and use it.

(3) After making the Quartz Crystal mount on a printed circuit board ,if it is required to divide the printed circuit board into another one, use it with attentive confirmation so that a warp caused by this dividing might not affect any damage. When designing a printed circuit board as well as handling the mounting As much as possible. The quartz crystal shall be passed through the reflow furnace. Then it shall be subjected to standard atmospheric conditions, after which cleaning shall be made.

11. Storage conditions

Storage at prolonged high temperature or low temperature and the storage by high humidity cause degradation of frequency accuracy, and degradation of soldering nature. Storage is performed at the temperature of 18-30 degrees C, and the humidity of 20-70 Percent in the state of packing, and a term is 6 months.

12. Others

When any questions and opinions are in the written matter of these delivery specifications, I will ask connection of you from the our company issue day within 45 days. In a connection no case, a written matter is consented to it and employed within a term.

13.LOT CALENDAR

WEEK	MONTH	MON	TUE	WED	THU	FRI	SAT	SUN	WEEK	MONTH	MON	TUE	WED	THU	FRI	SAT	SUN
週	月	月	火	水	木	金	土	日	週	月	月	火	水	木	金	土	日
152	1							1	227	7	2	3	4	5	6	7	8
201		2	3	4	5	6	7	8	228		9	10	11	12	13	14	15
202		9	10	11	12	13	14	15	229		16	17	18	19	20	21	22
203		16	17	18	19	20	21	22	230		23	24	25	26	27	28	29
204		23	24	25	26	27	28	29	231		8	30	31	1	2	3	4
205	2	30	31	1	2	3	4	5	232	6		7	8	9	10	11	12
206		6	7	8	9	10	11	12	233	13		14	15	16	17	18	19
207		13	14	15	16	17	18	19	234	20		21	22	23	24	25	26
208		20	21	22	23	24	25	26	235	9	27	28	29	30	31	1	2
209	3	27	28	29	1	2	3	4	236		3	4	5	6	7	8	9
210		5	6	7	8	9	10	11	237		10	11	12	13	14	15	16
211		12	13	14	15	16	17	18	238		17	18	19	20	21	22	23
212	19	20	21	22	23	24	25	239	24	25	26	27	28	29	30		
213	4	26	27	28	29	30	31	1	240	10	1	2	3	4	5	6	7
214		2	3	4	5	6	7	8	241		8	9	10	11	12	13	14
215		9	10	11	12	13	14	15	242		15	16	17	18	19	20	21
216		16	17	18	19	20	21	22	243		22	23	24	25	26	27	28
217	23	24	25	26	27	28	29	244	11	29	30	31	1	2	3	4	
218	5	30	1	2	3	4	5	6		245	5	6	7	8	9	10	11
219		7	8	9	10	11	12	13		246	12	13	14	15	16	17	18
220		14	15	16	17	18	19	20	247	19	20	21	22	23	24	25	
221	21	22	23	24	25	26	27	248	12	26	27	28	29	30	1	2	
222	6	28	29	30	31	1	2	3		249	3	4	5	6	7	8	9
223		4	5	6	7	8	9	10		250	10	11	12	13	14	15	16
224		11	12	13	14	15	16	17		251	17	18	19	20	21	22	23
225		18	19	20	21	22	23	24		252	24	25	26	27	28	29	30
226	7	25	26	27	28	29	30	1	253	31							