

阅读申明

- 1.本站收集的数据手册和产品资料都来自互联网，版权归原作者所有。如读者和版权方有任何异议请及时告之，我们将妥善解决。
- 2.本站提供的中文数据手册是英文数据手册的中文翻译，其目的是协助用户阅读，该译文无法自动跟随原稿更新，同时也可能存在翻译上的不当。建议读者以英文原稿为参考以便获得更精准的信息。
- 3.本站提供的产品资料，来自厂商的技术支持或者使用者的心得体会等，其内容可能存在描述上的差异，建议读者做出适当判断。
- 4.如需与我们联系，请发邮件到marketing@iczoom.com，主题请标有“数据手册”字样。

Read Statement

1. The datasheets and other product information on the site are all from network reference or other public materials, and the copyright belongs to the original author and original published source. If readers and copyright owners have any objections, please contact us and we will deal with it in a timely manner.
2. The Chinese datasheets provided on the website is a Chinese translation of the English datasheets. Its purpose is for reader's learning exchange only and do not involve commercial purposes. The translation cannot be automatically updated with the original manuscript, and there may also be improper translations. Readers are advised to use the English manuscript as a reference for more accurate information.
3. All product information provided on the website refer to solutions from manufacturers' technical support or users the contents may have differences in description, and readers are advised to take the original article as the standard.
4. If you have any questions, please contact us at marketing@iczoom.com and mark the subject with "Datasheets" .



150.00 MHz LVPECL Oscillator

High Performance Differential MEMS Oscillator

4MA150000Z3

DATASHEET

Features

- Frequency: 150.00 MHz
- Output Type: LVPECL
- Frequency Stability: ± 50 ppm
- Supply Voltage: 2.5V & 3.3V
- Standard Packages: 5.0 x 3.2 mm; 7.0 x 5.0 mm
- RMS phase jitter: 0.6ps typical (12k to 20MHz)
- Operating Temperature: -40 to 85 °C

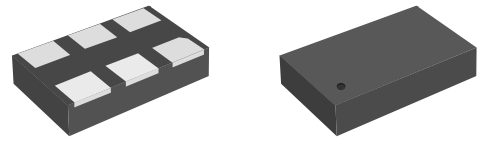

7.0 x 5.0 mm package shown
(also available in 5.0 x 3.2mm pkg)

Specification

Parameter	2.5 V Specifications			3.3 V Specifications			Units	Conditions
	Min	Typ	Max	Min	Typ	Max		
Supply Voltage (V_{DD})	2.375	2.50	2.625	2.97	3.30	3.63	V	
Output Frequency		150.00			150.00		MHz	
Frequency Stability	- 50		+ 50	- 50		+ 50	ppm	Includes supply voltage and temperature variation (-40 to 85°C), reflow drift, and aging.
Supply Current		95			100		mA	No load
Enable/Disable Time			1			1	us	Guaranteed by design
Input LOW level			0.3V _{DD}			0.3V _{DD}	V	At OE pin
Input HIGH level	0.7V _{DD}			0.7V _{DD}			V	At OE pin
Output LOW level		0.8	V _{DD} -1.8		1.5	V _{DD} -1.8	V	
Output HIGH level	V _{DD} -1.0	1.6		V _{DD} -1.1	2.3		V	
Amplitude (V_A)		0.75			0.75		V	Single Ended output swing (Pk-Pk)
Mid Level (V_M)		V _{DD} -1.3			V _{DD} -1.3		V	
Rise Time (T_R)		200	240		200	240	ps	Maximum; 20/80% of V_A ; Output load (CL) = 2pF; Guaranteed by Char.
Fall Time (T_F)		200	240		200	240	ps	Maximum; 20/80% of V_A ; Output load (CL) = 2pF; Guaranteed by Char.
Symmetry (SYM)	48	50	52	48	50	52	%	Worst case; measured at 50% of waveform
Phase Jitter		0.8			0.6		ps	12k to 20MHz, RMS; Measured Differentially
Period Jitter		2.8			2.6		ps	RMS
Cycle-to-Cycle Jitter		21			19		ps	1,000 cycles, Peak
Start-up Time		10			10		ms	Output valid time after power up, 25°C
Aging		± 5			± 5		ppm	25°C, 10 years

Block Diagram

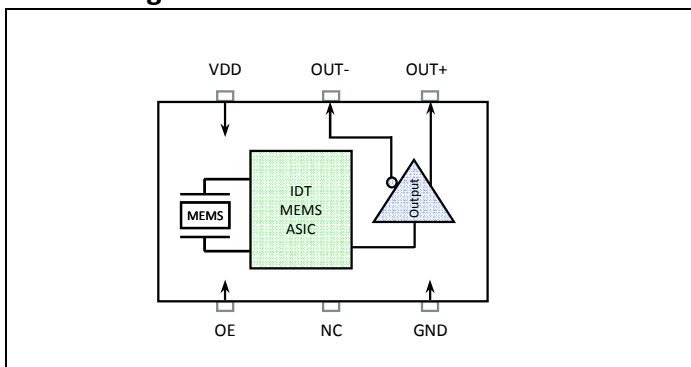

Output Waveform

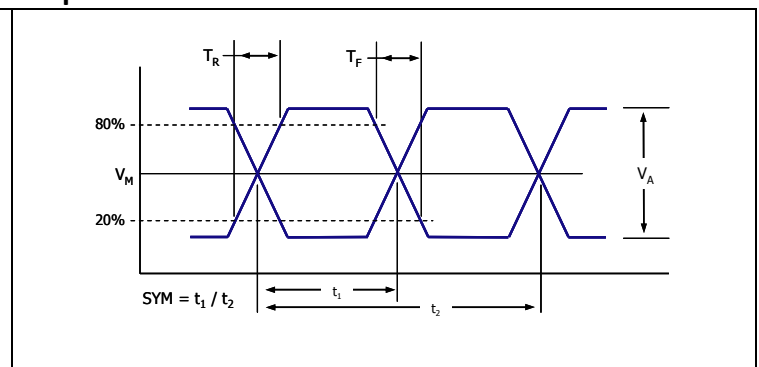

Part Ordering Information

Package Size	Voltage	Ordering Code
7.0 x 5.0 mm	3.3 V	4MA150000Z3AACUGI
	2.5 V	4MA150000Z3BACUGI
5.0 x 3.2 mm	3.3 V	4MA150000Z3AACTGI
	2.5 V	4MA150000Z3BACTGI

* Factory minimum order quantity: 500pcs (T/R)

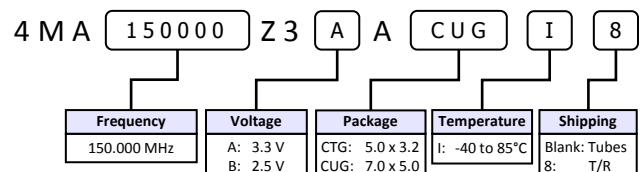

Pin Description

Pin #	Name	Description
1	OE	Output Enable*
2	NC	No Connect
3	GND	Ground
4	OUT+	Output
5	OUT-	Complementary Output
6	VDD	Power Supply Voltage

* Pulled high internally

Solder Reflow Profile

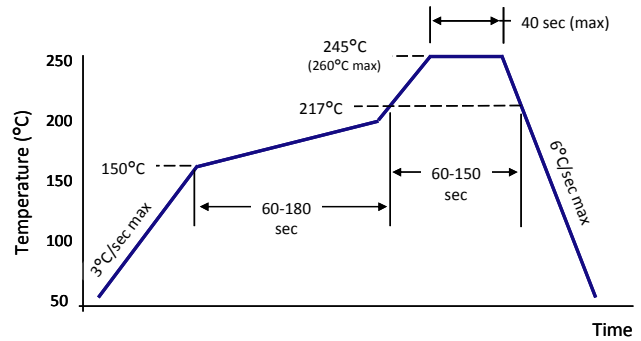

Package Outline and Dimensions

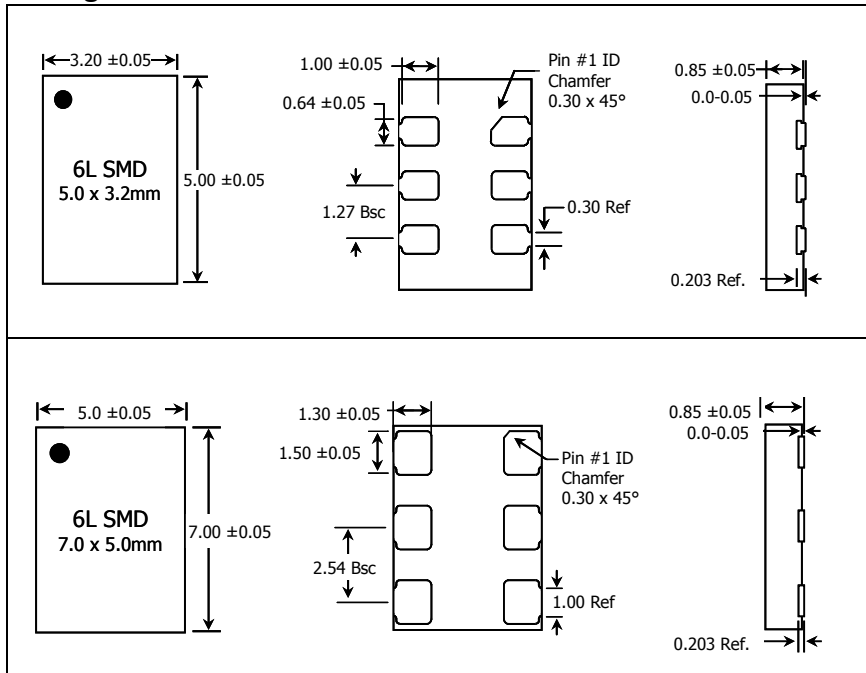

Typical PCB Land Pattern

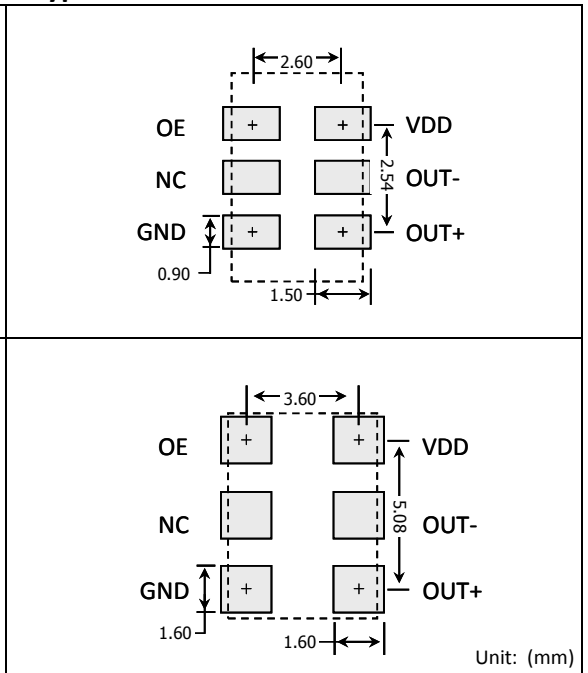

www.IDT.com

6024 Silver Creek Valley Road
San Jose, California 95138

Sales

800-345-7015 (inside USA)
+1 408-284-8200 (outside USA)

Technical Support

MEMS_Support@idt.com
www.idt.com/go/MEMS

DISCLAIMER Integrated Device Technology, Inc. (IDT) and its subsidiaries reserve the right to modify the products and/or specifications described herein at any time and at IDT's sole discretion. All information in this document, including descriptions of product features and performance, is subject to change without notice. Performance specifications and the operating parameters of the described products are determined in the independent state and are not guaranteed to perform the same way when installed in customer products. The information contained herein is provided without representation or warranty of any kind, whether express or implied, including, but not limited to, the suitability of IDT's products for any particular purpose, an implied warranty of merchantability, or non-infringement of the intellectual property rights of others. This document is presented only as a guide and does not convey any license under intellectual property rights of IDT or any third parties. IDT's products are not intended for use in life support systems or similar devices where the failure or malfunction of an IDT product can be reasonably expected to significantly affect the health or safety of users. Anyone using an IDT product in such a manner does so at their own risk, absent an express, written agreement by IDT.

Integrated Device Technology, IDT and the IDT logo are registered trademarks of IDT. Other trademarks and service marks used herein, including protected names, logos and designs, are the property of IDT or their respective third party owners. Copyright 2010, 2011, 2012. All rights reserved.