

## 阅读申明

- 1.本站收集的数据手册和产品资料都来自互联网，版权归原作者所有。如读者和版权方有任何异议请及时告之，我们将妥善解决。
- 2.本站提供的中文数据手册是英文数据手册的中文翻译，其目的是协助用户阅读，该译文无法自动跟随原稿更新，同时也可能存在翻译上的不当。建议读者以英文原稿为参考以便获得更精准的信息。
- 3.本站提供的产品资料，来自厂商的技术支持或者使用者的心得体会等，其内容可能存在描述上的差异，建议读者做出适当判断。
- 4.如需与我们联系，请发邮件到marketing@iczoom.com，主题请标有“数据手册”字样。

## Read Statement

1. The datasheets and other product information on the site are all from network reference or other public materials, and the copyright belongs to the original author and original published source. If readers and copyright owners have any objections, please contact us and we will deal with it in a timely manner.
2. The Chinese datasheets provided on the website is a Chinese translation of the English datasheets. Its purpose is for reader's learning exchange only and do not involve commercial purposes. The translation cannot be automatically updated with the original manuscript, and there may also be improper translations. Readers are advised to use the English manuscript as a reference for more accurate information.
3. All product information provided on the website refer to solutions from manufacturers' technical support or users the contents may have differences in description, and readers are advised to take the original article as the standard.
4. If you have any questions, please contact us at marketing@iczoom.com and mark the subject with "Datasheets" .

## CRYSTAL OSCILLATOR PROGRAMMABLE

### SG - 8003 series

- Frequency range : 1 MHz to 166 MHz
- Supply voltage : 1.8 V / 2.5 V / 3.0 V / 3.3 V
- Function : Output enable(OE) or Standby( $\overline{ST}$ )

- Short mass production lead time by PLL technology.
  - SG-Writer available to purchase.
- Please contact Epson Toyocom or local sales representative.



Product Number (please contact us)  
X1G003xx1xxxx00

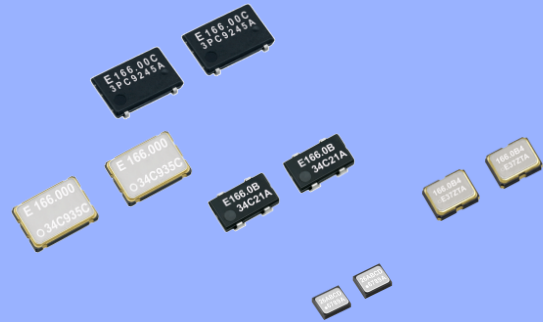

### Specifications (characteristics)

Item	Symbol	Specifications			Remarks
		PE / SE	PD / SD	PC / SC	
Output frequency range	$f_0$	1 MHz to 166 MHz			
Supply voltage	$V_{CC}$	1.8 V Typ. 1.6 V to 2.2 V	2.5 V Typ. 2.2 V to 2.8 V	3.3 V Typ. 2.7 V to 3.6 V	
Storage temperature	$T_{stg}$	-40 °C to +85 °C			Store as bare product.
Operating temperature	$T_{use}$	-20 °C to +70 °C / -40 °C to +85 °C			
Frequency tolerance	$f_{tol}$	B: $\pm 50 \times 10^{-6}$ , C: $\pm 100 \times 10^{-6}$			-20 °C to +70 °C
		L: $\pm 50 \times 10^{-6}$ , M: $\pm 100 \times 10^{-6}$			-40 °C to +85 °C
Current consumption	$I_{CC}$	3.5 mA Max.	4.0 mA Max.		No load condition, 1 MHz $\leq f_0 \leq 25$ MHz
		5.0 mA Max.	6.5 mA Max.		No load condition, 25 MHz $< f_0 \leq 50$ MHz
		6.0 mA Max.	8.5 mA Max.		No load condition, 50 MHz $< f_0 \leq 75$ MHz
		7.0 mA Max.	10.5 mA Max.		No load condition, 75 MHz $< f_0 \leq 100$ MHz
		8.5 mA Max.	12.5 mA Max.		No load condition, 100 MHz $< f_0 \leq 125$ MHz
		10.0 mA Max.	15.0 mA Max.		No load condition, 125 MHz $< f_0 \leq 166$ MHz
Output disable current	$I_{dis}$	8 mA Max.			OE=GND (PE,PD,PC)
Stand-by current	$I_{std}$	50 $\mu$ A Max.			$\overline{ST}$ =GND (SE,SD,SC)
Symmetry	SYM	45 % to 55 %			50 % $V_{CC}$ level, $L_{CMOS} \leq 15$ pF
Output voltage	$V_{OH}$	90 % $V_{CC}$ Min.		$V_{CC} - 0.4$ V Min.	$I_{OH} = -4$ mA (PD,SD,PE,SE), $-8.0$ mA (PC,SC)
	$V_{OL}$	10 % $V_{CC}$ Max.		0.4 V Max.	$I_{OL} = 4$ mA (PD,SD,PE,SE), $8.0$ mA (PC,SC)
Output load condition (CMOS)	$L_{CMOS}$	15 pF Max.			
Input voltage	$V_{IH}$	80 % $V_{CC}$ Min.			OE terminal or $\overline{ST}$ terminal
	$V_{IL}$	20 % $V_{CC}$ Max.			
Rise and Fall time	$t_r / t_f$	5.0 ns Max.			1 MHz $\leq f_0 < 80$ MHz   20 % $V_{CC}$ to 80 % $V_{CC}$
		2.5 ns Max.			80 MHz $\leq f_0 \leq 166$ MHz   level, $L_{CMOS} = 15$ pF
Start-up time	$t_{str}$	5 ms Max.			$t=0$ at 90 % $V_{CC}$
Frequency aging	$f_{aging}$	$\pm 3 \times 10^{-6}$ / year Max.			+25 °C, First year, $V_{CC} = 1.8$ V, 2.5 V, 3.3 V

### Current consumption

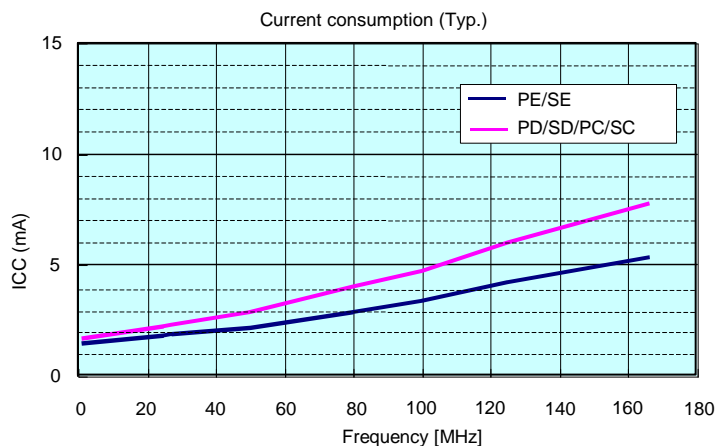

External dimensions

(Unit:mm)

Footprint (Recommended)

(Unit:mm)

SG-8003BA

Actual size

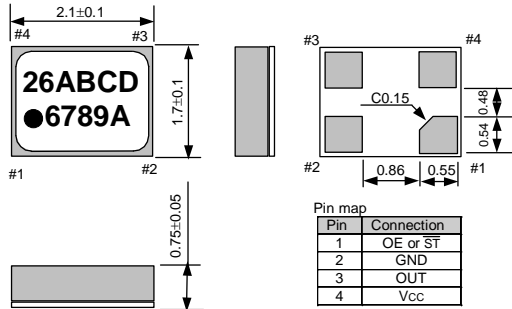
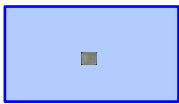

SG-8003BA

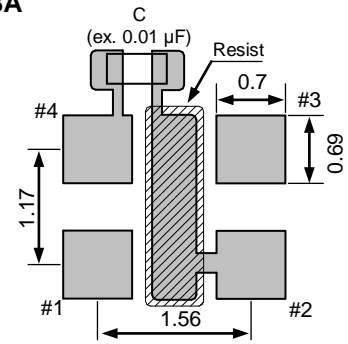

SG-8003CE

Actual size

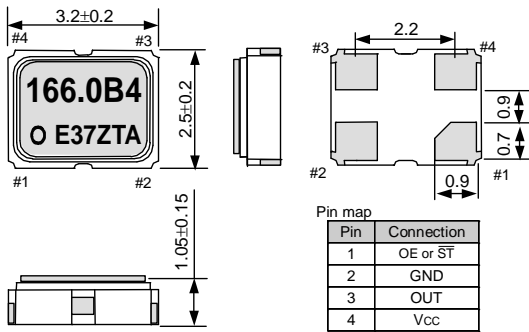

SG-8003CE

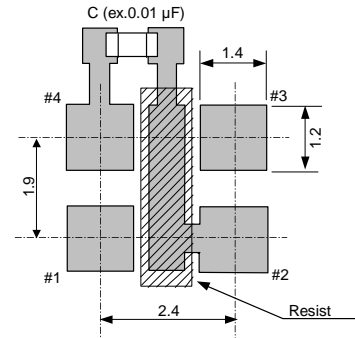

SG-8003LB

Actual size

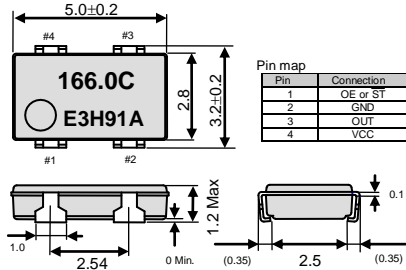

Metal may be exposed on the top or bottom of this product. This will not affect any quality, reliability or electrical spec.

SG-8003LB

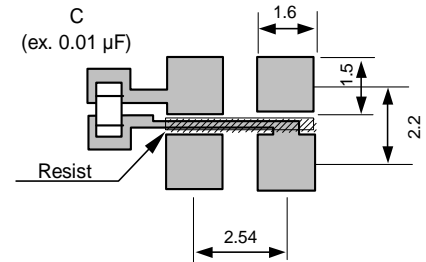

SG-8003CA

Actual size

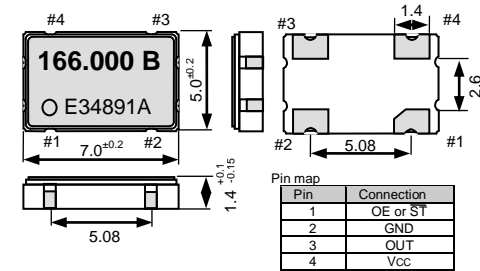

SG-8003CA

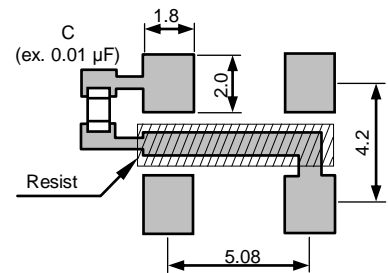

SG-8003JF

Actual size

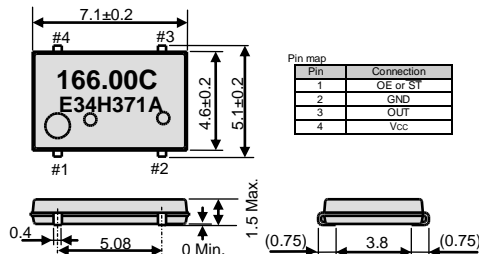

SG-8003JF

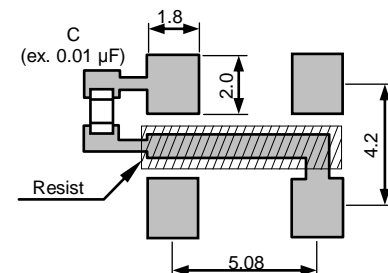

Note.

OE Pin (PE, PD, PC)  
 OE Pin = "H" or "open" : Specified frequency output.  
 OE Pin = "L" : Output is low level (weak pull - down)

ST Pin (SE, SD, SC)  
 ST Pin = "H" or "open" : Specified frequency output.  
 ST Pin = "L" : Output is low level (weak pull - down), oscillation stops.

To maintain stable operation, provide a 0.01uF to 0.1uF by-pass capacitor at a location as near as possible to the power source terminal of the crystal product (between Vcc - GND).