

阅读申明

- 1.本站收集的数据手册和产品资料都来自互联网，版权归原作者所有。如读者和版权方有任何异议请及时告之，我们将妥善解决。
- 2.本站提供的中文数据手册是英文数据手册的中文翻译，其目的是协助用户阅读，该译文无法自动跟随原稿更新，同时也可能存在翻译上的不当。建议读者以英文原稿为参考以便获得更精准的信息。
- 3.本站提供的产品资料，来自厂商的技术支持或者使用者的心得体会等，其内容可能存在描述上的差异，建议读者做出适当判断。
- 4.如需与我们联系，请发邮件到marketing@iczoom.com，主题请标有“数据手册”字样。

Read Statement

1. The datasheets and other product information on the site are all from network reference or other public materials, and the copyright belongs to the original author and original published source. If readers and copyright owners have any objections, please contact us and we will deal with it in a timely manner.
2. The Chinese datasheets provided on the website is a Chinese translation of the English datasheets. Its purpose is for reader's learning exchange only and do not involve commercial purposes. The translation cannot be automatically updated with the original manuscript, and there may also be improper translations. Readers are advised to use the English manuscript as a reference for more accurate information.
3. All product information provided on the website refer to solutions from manufacturers' technical support or users the contents may have differences in description, and readers are advised to take the original article as the standard.
4. If you have any questions, please contact us at marketing@iczoom.com and mark the subject with "Datasheets" .

HEXFRED®

Ultrafast, Soft Recovery Diode, 2 x 8 A

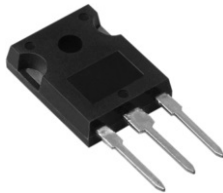
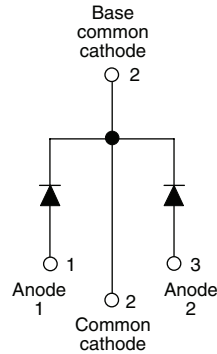
TO-247AC

FEATURES

- Ultrafast recovery
- Ultrasoft recovery
- Very low I_{RRM}
- Very low Q_{rr}
- Specified at operating conditions
- Designed and qualified for industrial level

BENEFITS

- Reduced RFI and EMI
- Reduced power loss in diode and switching transistor
- Higher frequency operation
- Reduced snubbing
- Reduced parts count

DESCRIPTION

HFA16PA60C is a state of the art center tap ultrafast recovery diode. Employing the latest in epitaxial construction and advanced processing techniques it features a superb combination of characteristics which result in performance which is unsurpassed by any rectifier previously available. With basic ratings of 600 V and 8 A per leg continuous current, the HFA16PA60C is especially well suited for use as the companion diode for IGBTs and MOSFETs. In addition to ultrafast recovery time, the HEXFRED® product line features extremely low values of peak recovery current (I_{RRM}) and does not exhibit any tendency to “snap-off” during the t_b portion of recovery. The HEXFRED features combine to offer designers a rectifier with lower noise and significantly lower switching losses in both the diode and the switching transistor. These HEXFRED advantages can help to significantly reduce snubbing, component count and heatsink sizes. The HEXFRED HFA16PA60C is ideally suited for applications in power supplies and power conversion systems (such as inverters), motor drives, and many other similar applications where high speed, high efficiency is needed.

PRODUCT SUMMARY

V_R	600 V
V_F at 8 A at 25 °C	1.7 V
$I_{F(AV)}$	2 x 8 A
t_{rr} (typical)	18 ns
T_J (maximum)	150 °C
Q_{rr}	65 nC
$di_{(rec)M}/dt$	240 A/ μ s

ABSOLUTE MAXIMUM RATINGS

PARAMETER	SYMBOL	TEST CONDITIONS	VALUES	UNITS
Cathode to anode voltage	V_R		600	V
Maximum continuous forward current	I_F	$T_C = 100\text{ °C}$	per leg	8
			per device	16
Single pulse forward current	I_{FSM}		60	A
Maximum repetitive forward current	I_{FRM}		24	
Maximum power dissipation	P_D	$T_C = 25\text{ °C}$	36	W
		$T_C = 100\text{ °C}$	14	
Operating junction and storage temperature range	T_J, T_{Stg}		- 55 to + 150	°C

ELECTRICAL SPECIFICATIONS PER LEG (T _J = 25 °C unless otherwise specified)						
PARAMETER	SYMBOL	TEST CONDITIONS	MIN.	TYP.	MAX.	UNITS
Cathode to anode breakdown voltage	V _{BR}	I _R = 100 μA	600	-	-	V
Maximum forward voltage	V _{FM}	I _F = 8.0 A	-	1.4	1.7	
		I _F = 16 A	-	1.7	2.1	
		I _F = 8.0 A, T _J = 125 °C	-	1.4	1.7	
Maximum reverse leakage current	I _{RM}	V _R = V _R rated	-	0.3	5.0	μA
		T _J = 125 °C, V _R = 0.8 x V _R rated	-	100	500	
Junction capacitance	C _T	V _R = 200 V	-	10	25	pF
Series inductance	L _S	Measured lead to lead 5 mm from package body	-	8.0	-	nH

DYNAMIC RECOVERY CHARACTERISTICS PER LEG (T _J = 25 °C unless otherwise specified)						
PARAMETER	SYMBOL	TEST CONDITIONS	MIN.	TYP.	MAX.	UNITS
Reverse recovery time See fig. 5, 6 and 16	t _{rr}	I _F = 1.0 A, di _F /dt = 200 A/μs, V _R = 30 V	-	18	-	ns
	t _{rr1}	T _J = 25 °C	-	37	55	
	t _{rr2}	T _J = 125 °C	-	55	90	
Peak recovery current See fig. 7 and 8	I _{RRM1}	T _J = 25 °C	-	3.5	5.0	A
	I _{RRM2}	T _J = 125 °C	-	4.5	8.0	
Reverse recovery charge See fig. 9 and 10	Q _{rr1}	T _J = 25 °C	-	65	138	nC
	Q _{rr2}	T _J = 125 °C	-	124	360	
Peak rate of fall recovery current during t _b See fig. 11 and 12	di _{(rec)M} /dt1	T _J = 25 °C	-	240	-	A/μs
	di _{(rec)M} /dt2	T _J = 125 °C	-	210	-	

THERMAL - MECHANICAL SPECIFICATIONS						
PARAMETER	SYMBOL	TEST CONDITIONS	MIN.	TYP.	MAX.	UNITS
Lead temperature	T _{lead}	0.063" from case (1.6 mm) for 10 s	-	-	300	°C
Junction to case, single leg conducting	R _{thJC}		-	-	3.5	K/W
Junction to case, both leg conducting			-	-	1.75	
Thermal resistance, junction to ambient	R _{thJA}	Typical socket mount	-	-	40	
Thermal resistance, case to heatsink	R _{thCS}	Mounting surface, flat, smooth and greased	-	0.25	-	
Weight			-	6.0	-	g
			-	0.21	-	oz.
Mounting torque			6.0 (5.0)	-	12 (10)	kgf · cm (lbf · in)
Marking device		Case style TO-247AC (JEDEC)	HFA16PA60C			

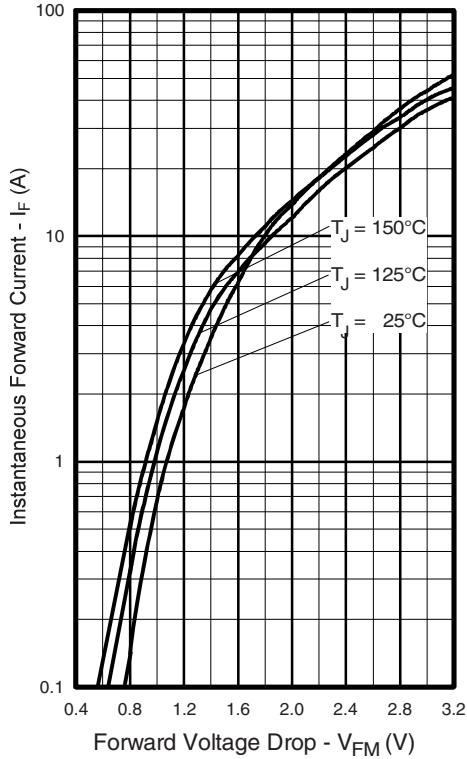

Fig. 1 - Maximum Forward Voltage Drop vs. Instantaneous Forward Current (Per Leg)

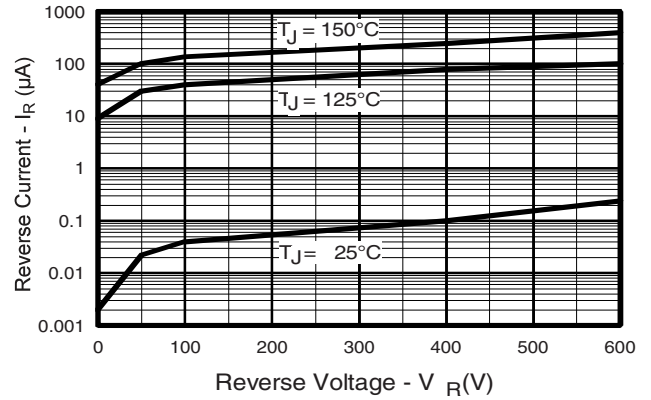

Fig. 2 - Typical Reverse Current vs. Reverse Voltage (Per Leg)

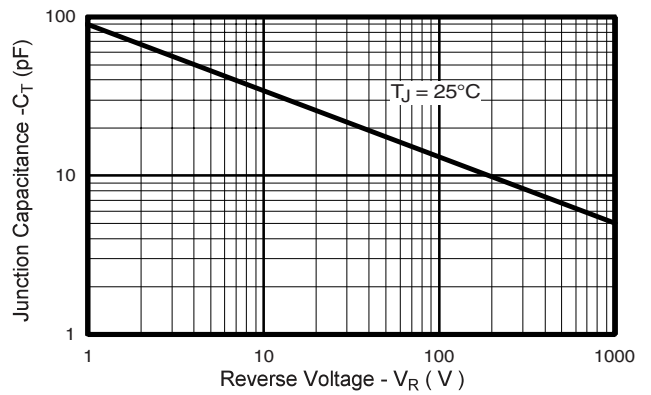

Fig. 3 - Typical Junction Capacitance vs. Reverse Voltage (Per Leg)

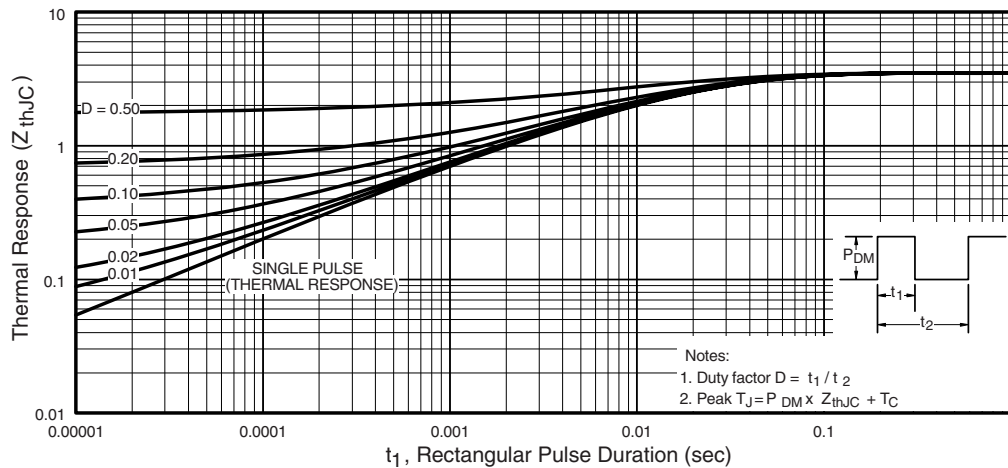

Fig. 4 - Maximum Thermal Impedance Z_{thJC} Characteristics (Per Leg)

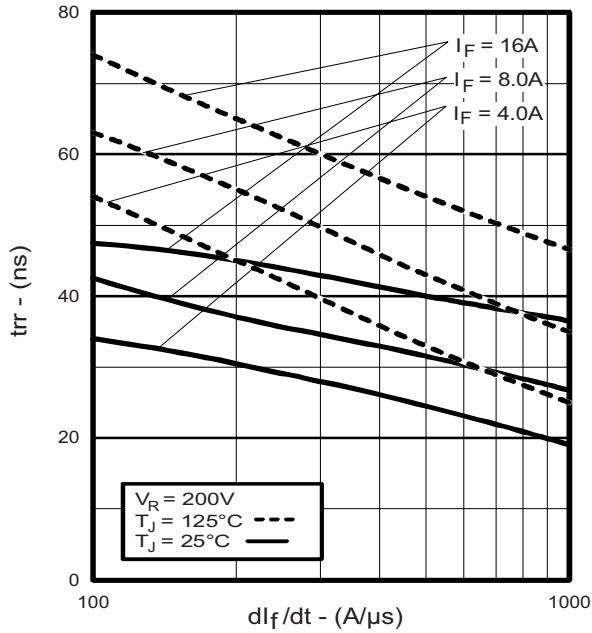

Fig. 5 - Typical Reverse Recovery Time vs. di/dt (Per Leg)

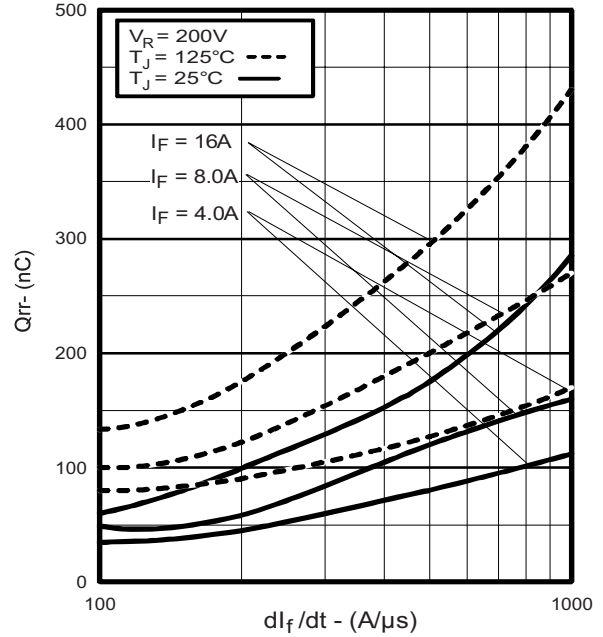

Fig. 7 - Typical Stored Charge vs. di/dt (Per Leg)

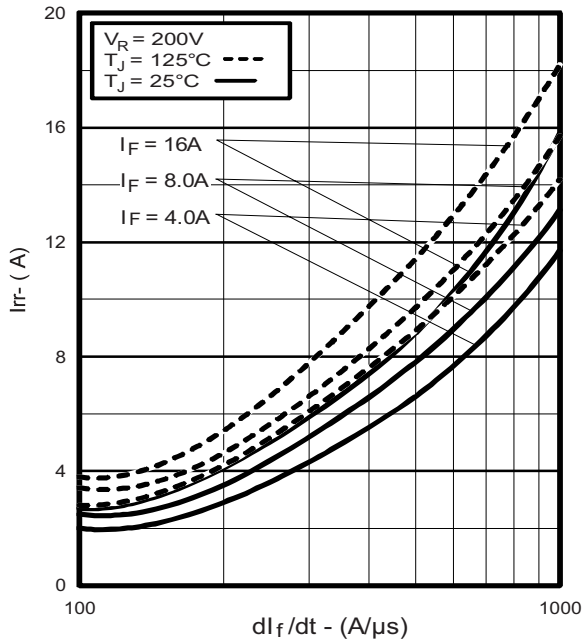

Fig. 6 - Typical Recovery Current vs. di/dt (Per Leg)

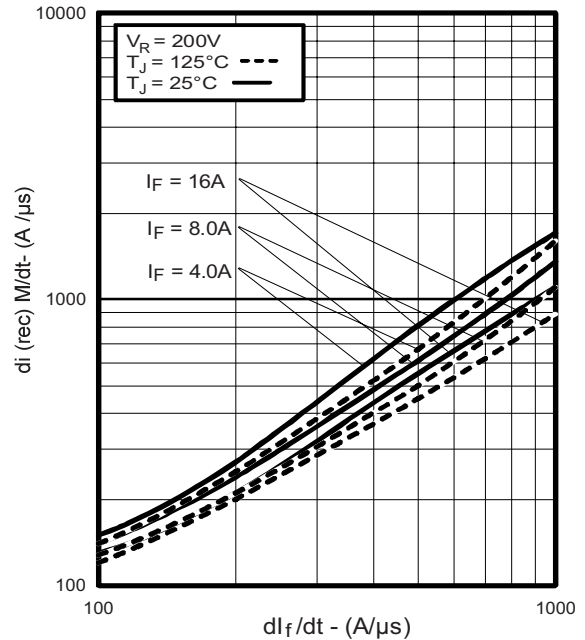

Fig. 8 - Typical $di_{(rec)M}/dt$ vs. di/dt (Per Leg)

HEXFRED®
 Ultrafast, Soft Recovery Diode, 2 x 8 A

Vishay High Power Products

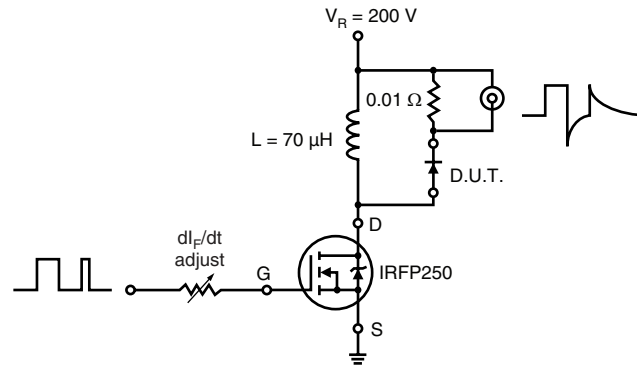
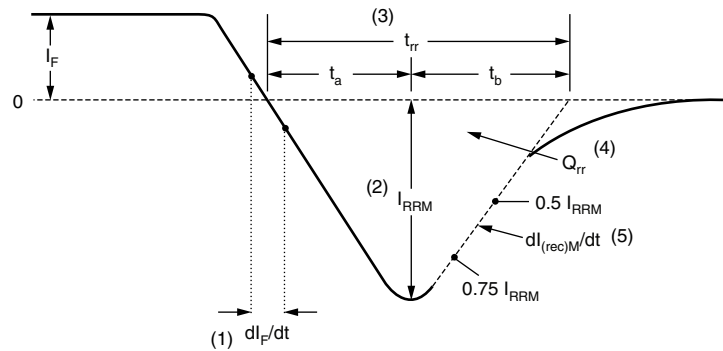

Fig. 9 - Reverse Recovery Parameter Test Circuit



- (1) di_F/dt - rate of change of current through zero crossing
- (2) I_{RRM} - peak reverse recovery current
- (3) t_{rr} - reverse recovery time measured from zero crossing point of negative going I_F to point where a line passing through $0.75 I_{RRM}$ and $0.50 I_{RRM}$ extrapolated to zero current.
- (4) Q_{rr} - area under curve defined by t_{rr} and I_{RRM}
- $$Q_{rr} = \frac{t_{rr} \times I_{RRM}}{2}$$
- (5) $di_{(rec)M}/dt$ - peak rate of change of current during t_b portion of t_{rr}

Fig. 10 - Reverse Recovery Waveform and Definitions

ORDERING INFORMATION TABLE

Device code	HF	A	16	PA	60	C	-
	①	②	③	④	⑤	⑥	⑦

- | | | |
|----------|---|--|
| 1 | - | HEXFRED® family |
| 2 | - | Process designator: A = Subs. elec. irradi.
B = Subs. platinum |
| 3 | - | Current rating (16 = 16 A) |
| 4 | - | Package outline (PA = TO-247, 3 pins) |
| 5 | - | Voltage rating (60 = 600 V) |
| 6 | - | Configuration (C = Center tap common cathode) |
| 7 | - | <ul style="list-style-type: none"> • None = Standard production • PbF = Lead (Pb)-free |

LINKS TO RELATED DOCUMENTS	
Dimensions	http://www.vishay.com/doc?95223
Part marking information	http://www.vishay.com/doc?95226



Disclaimer

All product specifications and data are subject to change without notice.

Vishay Intertechnology, Inc., its affiliates, agents, and employees, and all persons acting on its or their behalf (collectively, "Vishay"), disclaim any and all liability for any errors, inaccuracies or incompleteness contained herein or in any other disclosure relating to any product.

Vishay disclaims any and all liability arising out of the use or application of any product described herein or of any information provided herein to the maximum extent permitted by law. The product specifications do not expand or otherwise modify Vishay's terms and conditions of purchase, including but not limited to the warranty expressed therein, which apply to these products.

No license, express or implied, by estoppel or otherwise, to any intellectual property rights is granted by this document or by any conduct of Vishay.

The products shown herein are not designed for use in medical, life-saving, or life-sustaining applications unless otherwise expressly indicated. Customers using or selling Vishay products not expressly indicated for use in such applications do so entirely at their own risk and agree to fully indemnify Vishay for any damages arising or resulting from such use or sale. Please contact authorized Vishay personnel to obtain written terms and conditions regarding products designed for such applications.

Product names and markings noted herein may be trademarks of their respective owners.