

阅读申明

- 1.本站收集的数据手册和产品资料都来自互联网，版权归原作者所有。如读者和版权方有任何异议请及时告之，我们将妥善解决。
- 2.本站提供的中文数据手册是英文数据手册的中文翻译，其目的是协助用户阅读，该译文无法自动跟随原稿更新，同时也可能存在翻译上的不当。建议读者以英文原稿为参考以便获得更精准的信息。
- 3.本站提供的产品资料，来自厂商的技术支持或者使用者的心得体会等，其内容可能存在描述上的差异，建议读者做出适当判断。
- 4.如需与我们联系，请发邮件到marketing@iczoom.com，主题请标有“数据手册”字样。

Read Statement

1. The datasheets and other product information on the site are all from network reference or other public materials, and the copyright belongs to the original author and original published source. If readers and copyright owners have any objections, please contact us and we will deal with it in a timely manner.
2. The Chinese datasheets provided on the website is a Chinese translation of the English datasheets. Its purpose is for reader's learning exchange only and do not involve commercial purposes. The translation cannot be automatically updated with the original manuscript, and there may also be improper translations. Readers are advised to use the English manuscript as a reference for more accurate information.
3. All product information provided on the website refer to solutions from manufacturers' technical support or users the contents may have differences in description, and readers are advised to take the original article as the standard.
4. If you have any questions, please contact us at marketing@iczoom.com and mark the subject with "Datasheets" .

HFA60MC60C

HEXFRED™

Ultrafast, Soft Recovery Diode

Features

- Reduced RFI and EMI
- Reduced Snubbing
- Extensive Characterization of Recovery Parameters

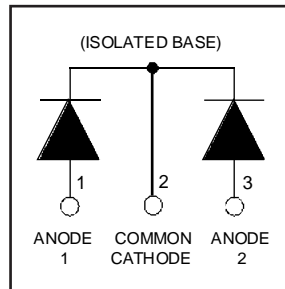

$V_R = 600V$
$V_F(\text{typ.})^{\textcircled{3}} = 1.1V$
$I_{F(AV)} = 60A$
$Q_{rr}(\text{typ.}) = 200nC$
$I_{RRM}(\text{typ.}) = 6A$
$t_{rr}(\text{typ.}) = 30ns$
$di_{(rec)}/dt(\text{typ.})^{\textcircled{3}} = 170A/\mu s$

Description

HEXFRED™ diodes are optimized to reduce losses and EMI/RFI in high frequency power conditioning systems. An extensive characterization of the recovery behavior for different values of current, temperature and di/dt simplifies the calculations of losses in the operating conditions. The softness of the recovery eliminates the need for a snubber in most applications. These devices are ideally suited for power converters, motors drives and other applications where switching losses are significant portion of the total losses.

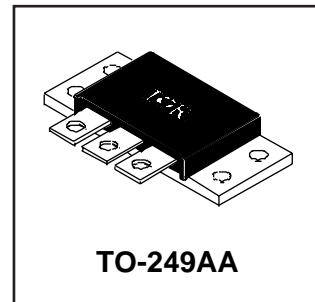

Absolute Maximum Ratings (per Leg)

	Parameter	Max.	Units
V_R	Cathode-to-Anode Voltage	600	V
$I_F @ T_C = 25^\circ C$	Continuous Forward Current	50	A
$I_F @ T_C = 100^\circ C$	Continuous Forward Current	24	
I_{FSM}	Single Pulse Forward Current ①	200	
E_{AS}	Non-Repetitive Avalanche Energy ②	220	μJ
$P_D @ T_C = 25^\circ C$	Maximum Power Dissipation	125	W
$P_D @ T_C = 100^\circ C$	Maximum Power Dissipation	50	
T_J T_{STG}	Operating Junction and Storage Temperature Range	-55 to +150	$^\circ C$
	Soldering Temperature, for 10 sec.	300 (0.063 in. (1.6mm) from case)	

Thermal - Mechanical Characteristics

	Parameter	Min.	Typ.	Max.	Units
$R_{\theta JC}$	Junction-to-Case, Single Leg Conducting	—	—	1.0	$^\circ C/W$
	Junction-to-Case, Both Legs Conducting	—	—	0.50	K/W
$R_{\theta CS}$	Case-to-Sink, Flat, Greased Surface	—	0.10	—	
Wt	Weight	—	58 (2.0)	—	g (oz)
	Mounting Torque	35 (4.0)	—	50 (5.7)	lbf•in (N•m)

Note: ① Limited by junction temperature
 ② L = 100 μH , duty cycle limited by max T_J
 ③ 125 $^\circ C$

HFA60MC60C

PD-2.463 rev. B 03/99

International
IOR Rectifier

Electrical Characteristics (per Leg) @ $T_J = 25^\circ\text{C}$ (unless otherwise specified)

	Parameter	Min.	Typ.	Max.	Units	Test Conditions
V_{BR}	Cathode Anode Breakdown Voltage	600	—	—	V	$I_R = 100\mu\text{A}$
V_{FM}	Max Forward Voltage	—	1.3	1.5	V	$I_F = 30\text{A}$ $I_F = 60\text{A}$ $I_F = 30\text{A}, T_J = 125^\circ\text{C}$ See Fig. 1
		—	1.4	1.7		
		—	1.1	1.3		
I_{RM}	Max Reverse Leakage Current	—	2.0	10	μA	$V_R = V_R$ Rated $T_J = 125^\circ\text{C}, V_R = 480\text{V}$ See Fig. 2
		—	0.50	2.0	mA	
C_T	Junction Capacitance	—	68	100	pF	$V_R = 200\text{V}$ See Fig. 3
L_S	Series Inductance	—	8.0	—	nH	From terminal hole to terminal hole

Dynamic Recovery Characteristics (per Leg) @ $T_J = 25^\circ\text{C}$ (unless otherwise specified)

	Parameter	Min.	Typ.	Max.	Units	Test Conditions
t_{rr}	Reverse Recovery Time	—	30	—	ns	$I_F = 1.0\text{A}, di_f/dt = 200\text{A}/\mu\text{s}, V_R = 30\text{V}$ $T_J = 25^\circ\text{C}$ See $T_J = 125^\circ\text{C}$ Fig. 5
t_{rr1}		—	67	100		
t_{rr2}		—	112	170		
I_{RRM1}	Peak Recovery Current	—	6.0	11	A	$T_J = 25^\circ\text{C}$ See $T_J = 125^\circ\text{C}$ Fig. 6
I_{RRM2}		—	9.0	16		
Q_{rr1}	Reverse Recovery Charge	—	200	550	nC	$T_J = 25^\circ\text{C}$ See $T_J = 125^\circ\text{C}$ Fig. 7
Q_{rr2}		—	500	1400		
$di_{(rec)M}/dt1$	Peak Rate of Fall of Recovery Current During t_b	—	250	—	A/ μs	$T_J = 25^\circ\text{C}$ See $T_J = 125^\circ\text{C}$ Fig. 8
$di_{(rec)M}/dt2$		—	170	—		

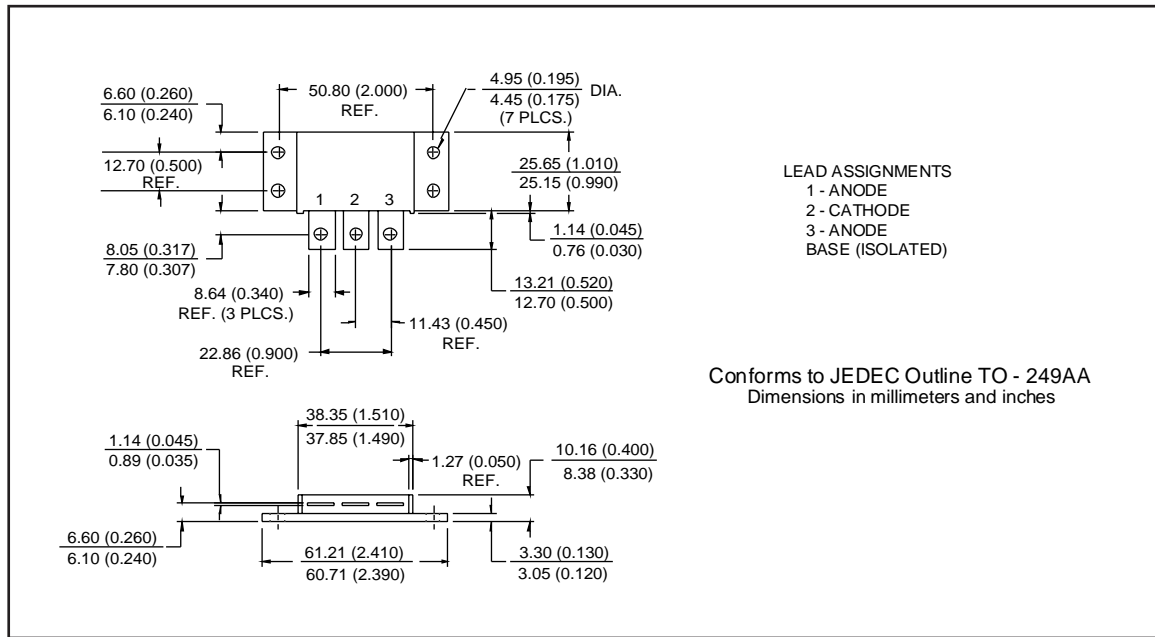

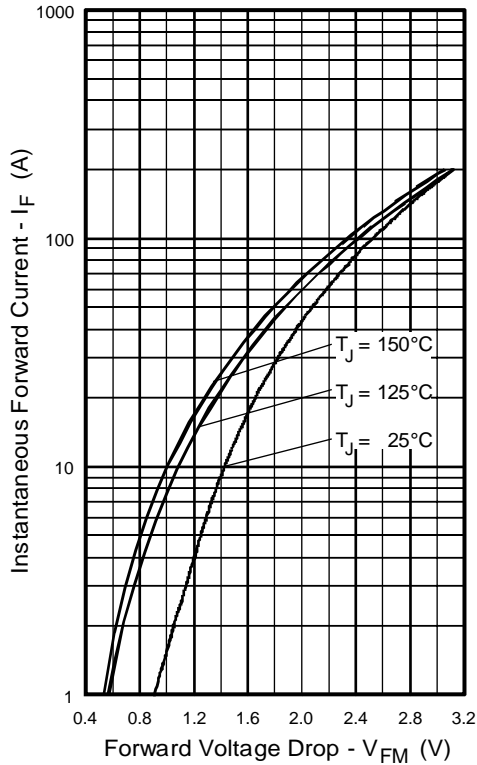

Fig. 1 - Maximum Forward Voltage Drop vs. Instantaneous Forward Current, (per Leg)

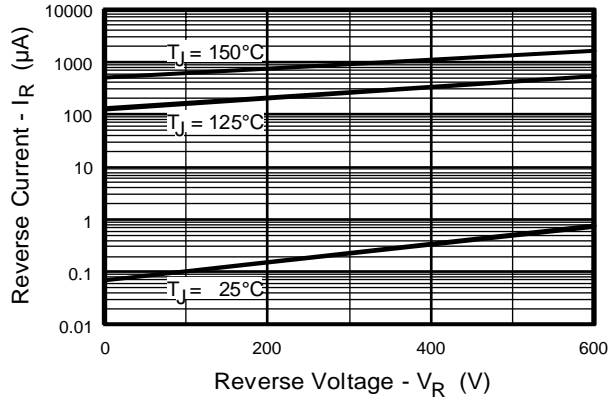

Fig. 2 - Typical Reverse Current vs. Reverse Voltage, (per Leg)

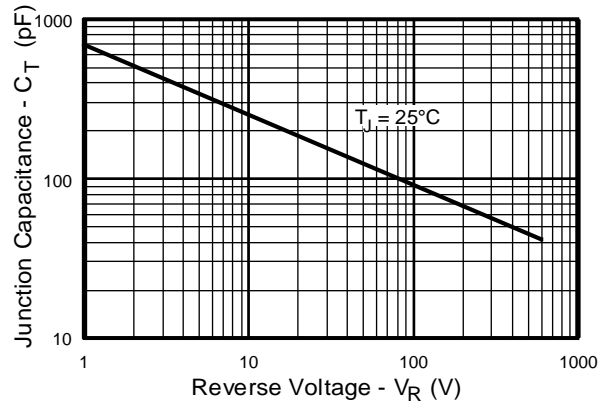

Fig. 3 - Typical Junction Capacitance vs. Reverse Voltage, (per Leg)

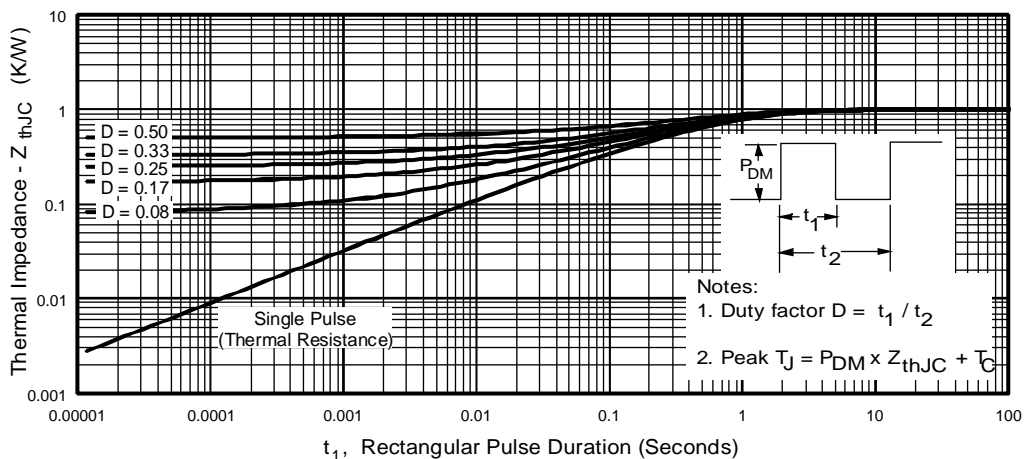

Fig. 4 - Maximum Thermal Impedance Z_{thJC} Characteristics, (per Leg)

HFA60MC60C

PD-2.463 rev. B 03/99

International
IOR Rectifier

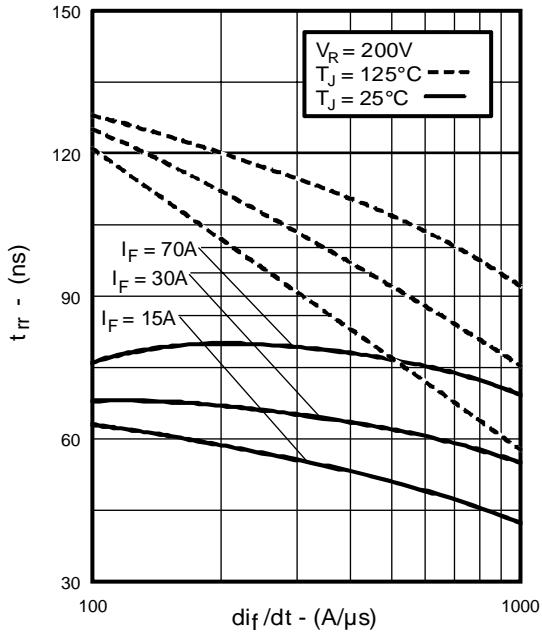

Fig. 5 - Typical Reverse Recovery vs. di_f/dt , (per Leg)

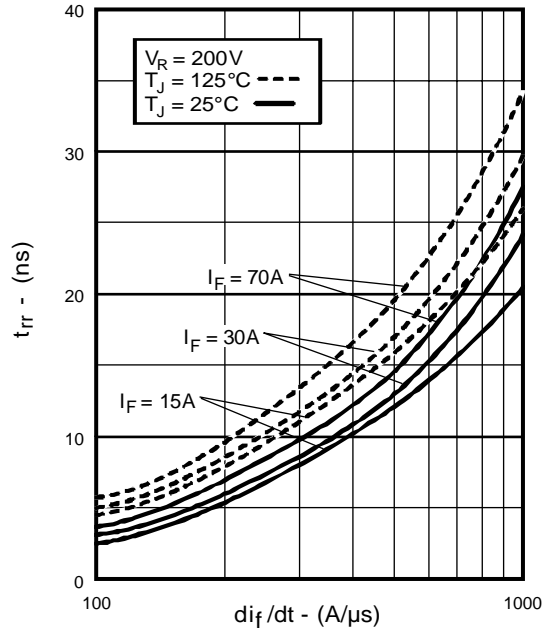

Fig. 6 - Typical Recovery Current vs. di_f/dt , (per Leg)

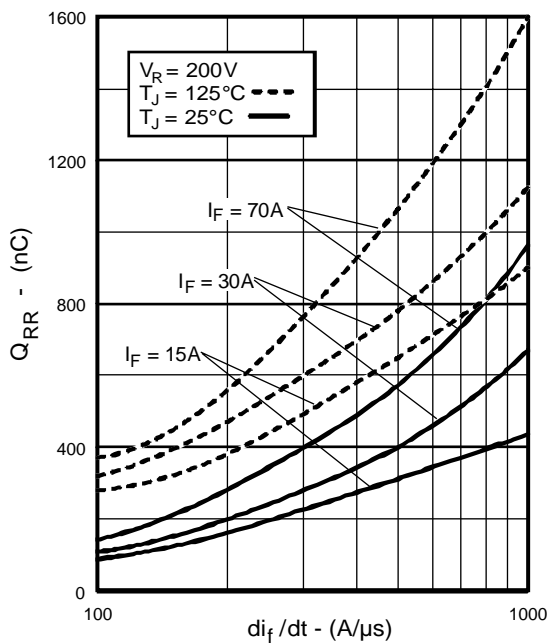

Fig. 7 - Typical Stored Charge vs. di_f/dt , (per Leg)

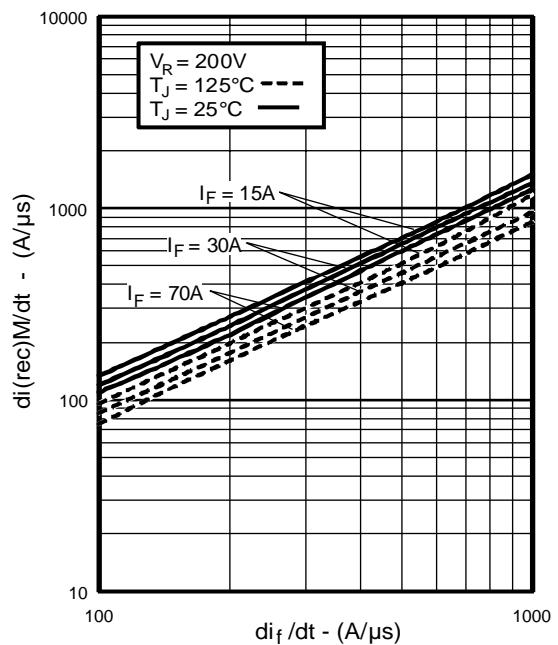

Fig. 8 - Typical $di_{(rec)M}/dt$ vs. di_f/dt , (per Leg)

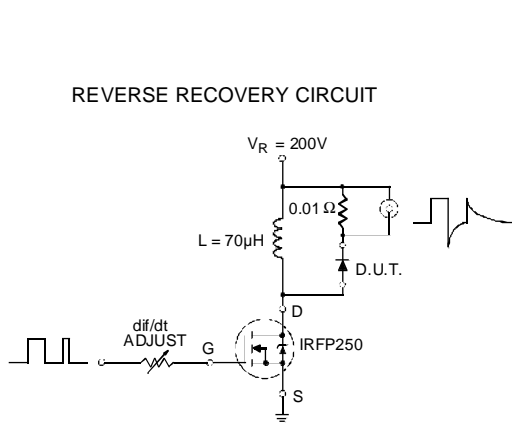
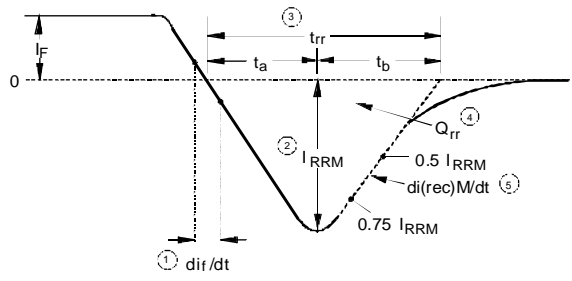

Fig. 9 - Reverse Recovery Parameter Test Circuit



1. di/dt - Rate of change of current through zero crossing
2. I_{RRM} - Peak reverse recovery current
3. t_{rr} - Reverse recovery time measured from zero crossing point of negative going I_F to point where a line passing through $0.75 I_{RRM}$ and $0.50 I_{RRM}$ extrapolated to zero current
4. Q_{rr} - Area under curve defined by t_{rr} and I_{RRM}
5. $di_{(rec)}/dt$ - Peak rate of change of current during t_b portion of t_{rr}

$$Q_{rr} = \frac{t_{rr} \times I_{RRM}}{2}$$

Fig. 10 - Reverse Recovery Waveform and Definitions

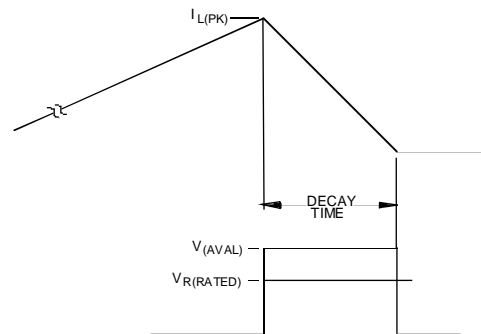
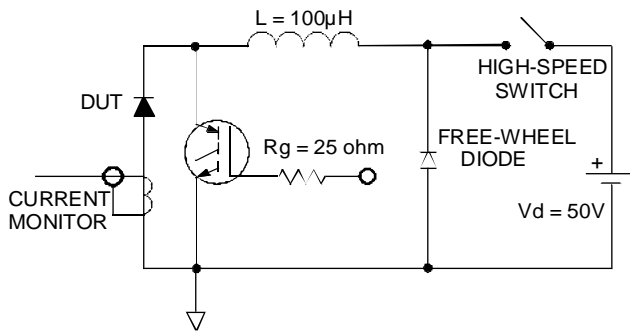

Fig. 11 - Avalanche Test Circuit and Waveforms