

## 阅读申明

- 1.本站收集的数据手册和产品资料都来自互联网，版权归原作者所有。如读者和版权方有任何异议请及时告之，我们将妥善解决。
- 2.本站提供的中文数据手册是英文数据手册的中文翻译，其目的是协助用户阅读，该译文无法自动跟随原稿更新，同时也可能存在翻译上的不当。建议读者以英文原稿为参考以便获得更精准的信息。
- 3.本站提供的产品资料，来自厂商的技术支持或者使用者的心得体会等，其内容可能存在描述上的差异，建议读者做出适当判断。
- 4.如需与我们联系，请发邮件到marketing@iczoom.com，主题请标有“数据手册”字样。

## Read Statement

1. The datasheets and other product information on the site are all from network reference or other public materials, and the copyright belongs to the original author and original published source. If readers and copyright owners have any objections, please contact us and we will deal with it in a timely manner.
2. The Chinese datasheets provided on the website is a Chinese translation of the English datasheets. Its purpose is for reader's learning exchange only and do not involve commercial purposes. The translation cannot be automatically updated with the original manuscript, and there may also be improper translations. Readers are advised to use the English manuscript as a reference for more accurate information.
3. All product information provided on the website refer to solutions from manufacturers' technical support or users the contents may have differences in description, and readers are advised to take the original article as the standard.
4. If you have any questions, please contact us at marketing@iczoom.com and mark the subject with "Datasheets" .

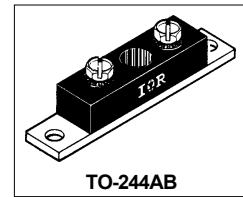

**Major Ratings and Characteristics**

Characteristics	409CNQ...	Units
$I_{F(AV)}$ Rectangular waveform	400	A
$V_{RRM}$ range	135 to 150	V
$I_{FSM}$ @tp=5µs sine	20000	A
$V_F$ @200Apk, $T_J=125^\circ\text{C}$ (perleg)	0.72	V
$T_J$ range	-55to 175	$^\circ\text{C}$

**Description/Features**

The 409CNQ center tap Schottky rectifier module series has been optimized for low reverse leakage at high temperature. The proprietary barrier technology allows for reliable operation up to 175 °C junction temperature. Typical applications are in high current switching power supplies, plating power supplies, UPS systems, converters, free-wheeling diodes, welding, and reverse battery protection.

- 175 °C  $T_J$  operation
- Center tap module
- High purity, high temperature epoxy encapsulation for enhanced mechanical strength and moisture resistance
- Low forward voltage drop
- High frequency operation
- Guard ring for enhanced ruggedness and long term reliability

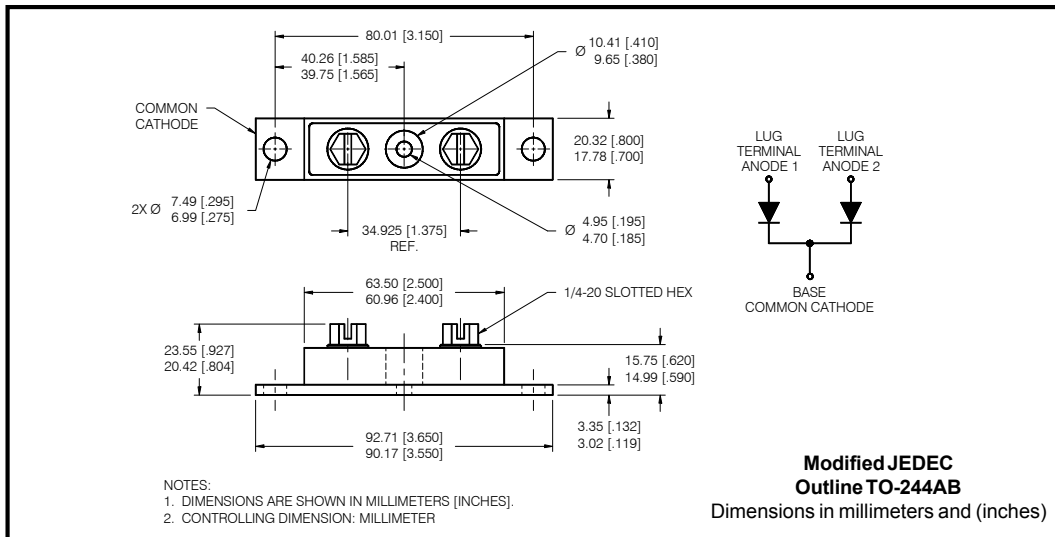

## Voltage Ratings

Partnumber	409CNQ135	409CNQ150
$V_R$ Max. DC Reverse Voltage (V)	135	150
$V_{RWM}$ Max. Working Peak Reverse Voltage (V)		

## Absolute Maximum Ratings

Parameters	409CNQ	Units	Conditions
$I_{F(AV)}$ Max. Average Forward Current (Per Leg) * See Fig. 5 (Per device)	200 400	A	50% duty cycle @ $T_C = 125^\circ\text{C}$ , rectangular wave form
$I_{FSM}$ Max. Peak One Cycle Non-Repetitive Surge Current (Per Leg) * See Fig. 7	20000 2300	A	5 $\mu\text{s}$ Sine or 3 $\mu\text{s}$ Rect. pulse 10ms Sine or 6ms Rect. pulse Following any rated load condition and with rated $V_{RWM}$ applied
$E_{AS}$ Non-Repetitive Avalanche Energy (Per Leg)	15	mJ	$T_J = 25^\circ\text{C}$ , $I_{AS} = 1$ Amps, $L = 30$ mH
$I_{AR}$ Repetitive Avalanche Current (Per Leg)	1	A	Current decaying linearly to zero in 1 $\mu\text{sec}$ Frequency limited by $T_J$ max. $V_A = 1.5 \times V_R$ typical

## Electrical Specifications

Parameters	409CNQ	Units	Conditions
$V_{FM}$ Max. Forward Voltage Drop (Per Leg) * See Fig. 1 (1)	1.03	V	@ 200A $T_J = 25^\circ\text{C}$
	1.21	V	@ 400A
	0.72	V	@ 200A $T_J = 125^\circ\text{C}$
	0.83	V	@ 400A
$I_{RM}$ Max. Reverse Leakage Current (Per Leg) * See Fig. 2 (1)	6	mA	$T_J = 25^\circ\text{C}$ $V_R = \text{rated } V_R$
	85	mA	$T_J = 125^\circ\text{C}$
$C_T$ Max. Junction Capacitance (Per Leg)	6000	pF	$V_R = 5V_{DC}$ , (test signal range 100Khz to 1Mhz) $25^\circ\text{C}$
$L_S$ Typical Series Inductance (Per Leg)	5.0	nH	From top of terminal hole to mounting plane
dv/dt Max. Voltage Rate of Change (Rated $V_R$ )	10000	V/ $\mu\text{s}$	

(1) Pulse Width < 300 $\mu\text{s}$ , Duty Cycle < 2%

## Thermal-Mechanical Specifications

Parameters	409CNQ	Units	Conditions
$T_J$ Max. Junction Temperature Range	-55 to 175	$^\circ\text{C}$	
$T_{stg}$ Max. Storage Temperature Range	-55 to 175	$^\circ\text{C}$	
$R_{thJC}$ Max. Thermal Resistance Junction to Case (Per Leg)	0.20	$^\circ\text{C/W}$	DC operation * See Fig. 4
$R_{thJC}$ Max. Thermal Resistance Junction to Case (Per Package)	0.10	$^\circ\text{C/W}$	DC operation
$R_{thCS}$ Typical Thermal Resistance, Case to Heatsink	0.10	$^\circ\text{C/W}$	Mounting surface, smooth and greased
wt Approximate Weight	79(2.80)	g(oz.)	
T Mounting Torque	Base	Min.	24(20)
		Max.	35(30)
	Center Hole	Typ.	13.5(12)
		Min.	35(30)
		Max.	46(40)
Terminal Torque			
Case Style	TO-244AB		Modified JEDEC

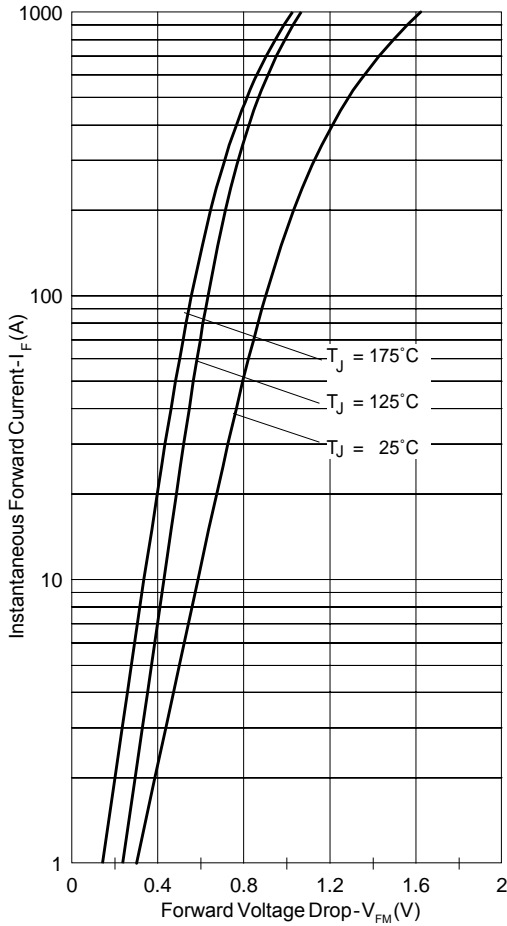

Fig. 1 - Max. Forward Voltage Drop Characteristics

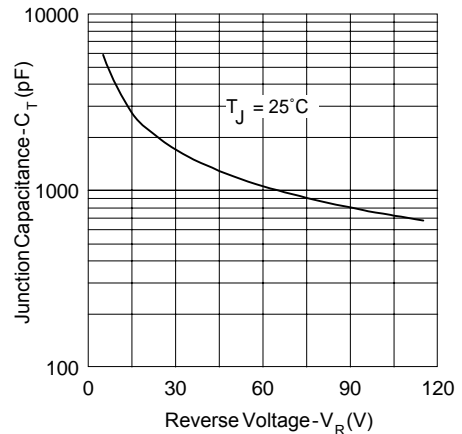
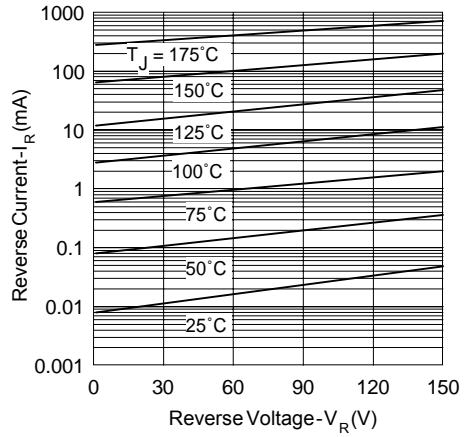

Fig. 3 - Typical Junction Capacitance Vs. Reverse Voltage

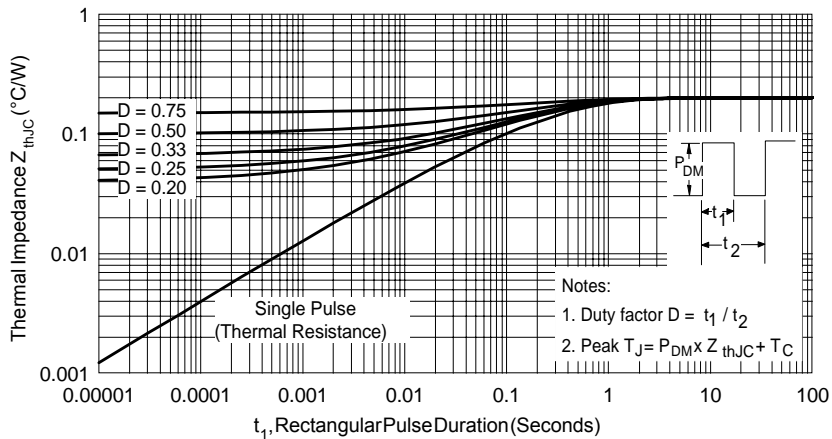

Fig. 4 - Max. Thermal Impedance  $Z_{thJC}$  Characteristics

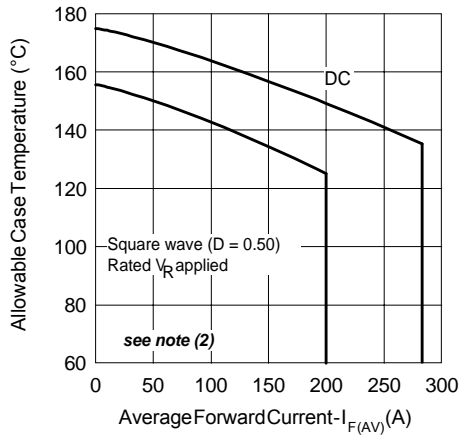

Fig. 5 - Max. Allowable Case Temperature Vs. Average Forward Current

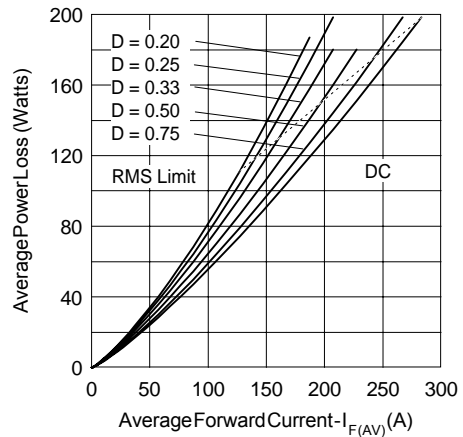

Fig. 6 - Forward Power Loss Characteristics

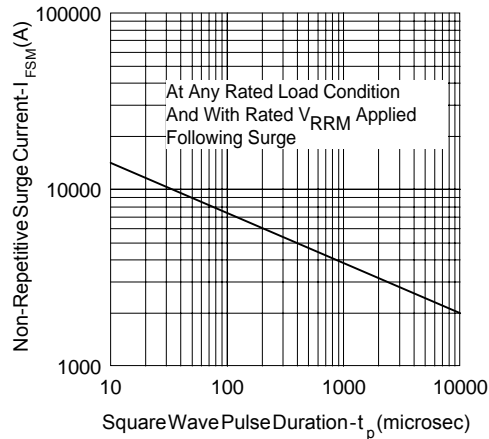

Fig. 7 - Max. Non-Repetitive Surge Current

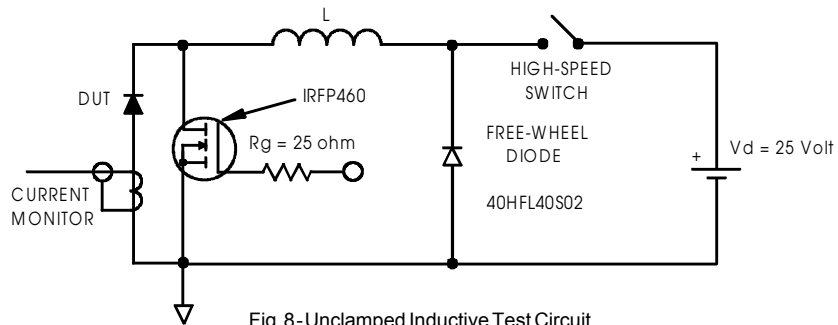

Fig. 8 - Unclamped Inductive Test Circuit

(2) Formula used:  $T_C = T_J - (P_d + P_{d_{REV}}) \times R_{thJC}$ ;

$P_d$  = Forward Power Loss =  $I_{F(AV)} \times V_{FM} @ (I_{F(AV)} / D)$  (see Fig. 6);

$P_{d_{REV}}$  = Inverse Power Loss =  $V_{R1} \times I_R (1 - D)$ ;  $I_R @ V_{R1}$  = rated  $V_R$

Data and specifications subject to change without notice.  
This product has been designed and qualified for Industrial Level.  
Qualification Standards can be found on IR's Web site.

International  
**IOR** Rectifier

**IR WORLD HEADQUARTERS:** 233 Kansas St., El Segundo, California 90245, USA Tel: (310) 252-7105  
TAC Fax: (310) 252-7309  
Visit us at [www.irf.com](http://www.irf.com) for sales contact information. 07/01