

阅读申明

- 1.本站收集的数据手册和产品资料都来自互联网，版权归原作者所有。如读者和版权方有任何异议请及时告之，我们将妥善解决。
- 2.本站提供的中文数据手册是英文数据手册的中文翻译，其目的是协助用户阅读，该译文无法自动跟随原稿更新，同时也可能存在翻译上的不当。建议读者以英文原稿为参考以便获得更精准的信息。
- 3.本站提供的产品资料，来自厂商的技术支持或者使用者的心得体会等，其内容可能存在描述上的差异，建议读者做出适当判断。
- 4.如需与我们联系，请发邮件到marketing@iczoom.com，主题请标有“数据手册”字样。

Read Statement

1. The datasheets and other product information on the site are all from network reference or other public materials, and the copyright belongs to the original author and original published source. If readers and copyright owners have any objections, please contact us and we will deal with it in a timely manner.
2. The Chinese datasheets provided on the website is a Chinese translation of the English datasheets. Its purpose is for reader's learning exchange only and do not involve commercial purposes. The translation cannot be automatically updated with the original manuscript, and there may also be improper translations. Readers are advised to use the English manuscript as a reference for more accurate information.
3. All product information provided on the website refer to solutions from manufacturers' technical support or users the contents may have differences in description, and readers are advised to take the original article as the standard.
4. If you have any questions, please contact us at marketing@iczoom.com and mark the subject with "Datasheets" .

**Dual Boost chopper
Trench + Field Stop IGBT®
Power Module**

**$V_{CES} = 600V$
 $I_C = 30A @ T_c = 80^\circ C$**

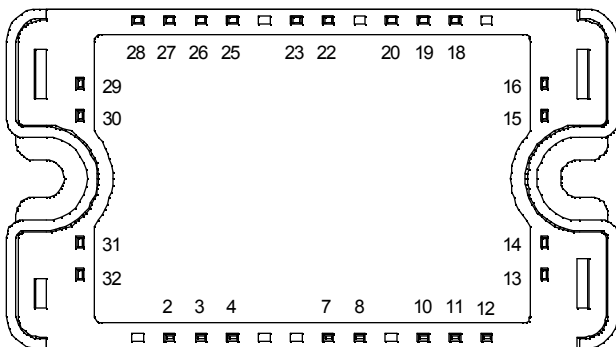
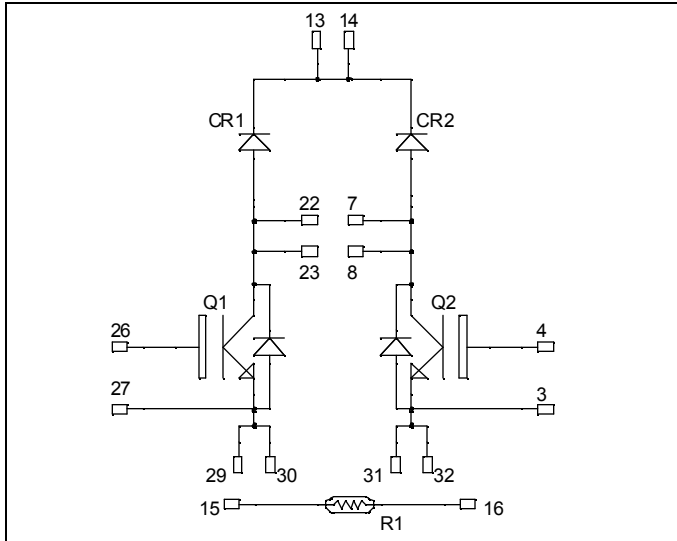

All multiple inputs and outputs must be shorted together
 Example: 13/14 ; 29/30 ; 22/23 ...

Application

- AC and DC motor control
- Switched Mode Power Supplies
- Power Factor Correction

Features

- Trench + Field Stop IGBT® Technology
 - Low voltage drop
 - Low tail current
 - Switching frequency up to 20 kHz
 - Soft recovery parallel diodes
 - Low diode VF
 - Low leakage current
 - Avalanche energy rated
 - RBSOA and SCSOA rated
- Kelvin emitter for easy drive
- Very low stray inductance
 - Symmetrical design
- High level of integration
- Internal thermistor for temperature monitoring

Benefits

- Stable temperature behavior
- Very rugged
- Solderable terminals for easy PCB mounting
- Direct mounting to heatsink (isolated package)
- Low junction to case thermal resistance
- Easy paralleling due to positive TC of VCESat
- Low profile
- Each leg can be easily paralleled to achieve a single boost of twice the current capability.
- RoHS Compliant

Absolute maximum ratings

| Symbol | Parameter | Max ratings | Unit |
|-----------|---------------------------------------|---------------------|------------|
| V_{CES} | Collector - Emitter Breakdown Voltage | 600 | V |
| I_C | Continuous Collector Current | $T_C = 25^\circ C$ | 50 |
| | | $T_C = 80^\circ C$ | 30 |
| I_{CM} | Pulsed Collector Current | $T_C = 25^\circ C$ | 60 |
| V_{GE} | Gate - Emitter Voltage | ± 20 | V |
| P_D | Maximum Power Dissipation | $T_C = 25^\circ C$ | 90 |
| RBSOA | Reverse Bias Safe Operating Area | $T_J = 150^\circ C$ | 60A @ 550V |

CAUTION: These Devices are sensitive to Electrostatic Discharge. Proper Handling Procedures Should Be Followed. See application note APT0502 on www.microsemi.com

All ratings @ $T_j = 25^\circ\text{C}$ unless otherwise specified

Electrical Characteristics

| Symbol | Characteristic | Test Conditions | Min | Typ | Max | Unit |
|---------------|--------------------------------------|---|---------------------------|-----|-----|---------------|
| I_{CES} | Zero Gate Voltage Collector Current | $V_{GE} = 0\text{V}$, $V_{CE} = 600\text{V}$ | | | 250 | μA |
| $V_{CE(sat)}$ | Collector Emitter Saturation Voltage | $V_{GE} = 15\text{V}$ $I_C = 30\text{A}$ | $T_j = 25^\circ\text{C}$ | 1.5 | 1.9 | V |
| | | | $T_j = 150^\circ\text{C}$ | 1.7 | | |
| $V_{GE(th)}$ | Gate Threshold Voltage | $V_{GE} = V_{CE}$, $I_C = 400\mu\text{A}$ | 5.0 | 5.8 | 6.5 | V |
| I_{GES} | Gate – Emitter Leakage Current | $V_{GE} = 20\text{V}$, $V_{CE} = 0\text{V}$ | | | 300 | nA |

Dynamic Characteristics

| Symbol | Characteristic | Test Conditions | Min | Typ | Max | Unit |
|--------------|------------------------------|--|---------------------------|------|-----|------|
| C_{ies} | Input Capacitance | $V_{GE} = 0\text{V}$ | | 1600 | | pF |
| C_{oes} | Output Capacitance | $V_{CE} = 25\text{V}$ | | 110 | | |
| C_{res} | Reverse Transfer Capacitance | $f = 1\text{MHz}$ | | 50 | | |
| $T_{d(on)}$ | Turn-on Delay Time | Inductive Switching (25°C) | | 110 | | ns |
| T_r | Rise Time | $V_{GE} = \pm 15\text{V}$ | | 45 | | |
| $T_{d(off)}$ | Turn-off Delay Time | $V_{Bus} = 300\text{V}$ | | 200 | | |
| T_f | Fall Time | $I_C = 30\text{A}$ $R_G = 10\Omega$ | | 40 | | |
| $T_{d(on)}$ | Turn-on Delay Time | Inductive Switching (150°C) | | 120 | | ns |
| T_r | Rise Time | $V_{GE} = \pm 15\text{V}$ | | 50 | | |
| $T_{d(off)}$ | Turn-off Delay Time | $V_{Bus} = 300\text{V}$ | | 250 | | |
| T_f | Fall Time | $I_C = 30\text{A}$ $R_G = 10\Omega$ | | 60 | | |
| E_{on} | Turn-on Switching Energy | $V_{GE} = \pm 15\text{V}$ $V_{Bus} = 300\text{V}$ | $T_j = 25^\circ\text{C}$ | 0.16 | | mJ |
| | | | $T_j = 150^\circ\text{C}$ | 0.3 | | |
| E_{off} | Turn-off Switching Energy | $I_C = 30\text{A}$ $R_G = 10\Omega$ | $T_j = 25^\circ\text{C}$ | 0.7 | | mJ |
| | | | $T_j = 150^\circ\text{C}$ | 1.05 | | |

Chopper diode ratings and characteristics

| Symbol | Characteristic | Test Conditions | Min | Typ | Max | Unit |
|-----------|---|---|---------------------------|------|-----|---------------|
| V_{RRM} | Maximum Peak Repetitive Reverse Voltage | | 600 | | | V |
| I_{RM} | Maximum Reverse Leakage Current | $V_R = 600\text{V}$ | $T_j = 25^\circ\text{C}$ | | 250 | μA |
| | | | $T_j = 150^\circ\text{C}$ | | 500 | |
| I_F | DC Forward Current | | $T_c = 80^\circ\text{C}$ | 30 | | A |
| V_F | Diode Forward Voltage | $I_F = 30\text{A}$ $V_{GE} = 0\text{V}$ | $T_j = 25^\circ\text{C}$ | 1.6 | 2 | V |
| | | | $T_j = 150^\circ\text{C}$ | 1.5 | | |
| t_{rr} | Reverse Recovery Time | | $T_j = 25^\circ\text{C}$ | 100 | | ns |
| | | | $T_j = 150^\circ\text{C}$ | 150 | | |
| Q_{rr} | Reverse Recovery Charge | $I_F = 30\text{A}$ $V_R = 300\text{V}$ $di/dt = 1800\text{A}/\mu\text{s}$ | $T_j = 25^\circ\text{C}$ | 1.5 | | μC |
| | | | $T_j = 150^\circ\text{C}$ | 3.1 | | |
| E_r | Reverse Recovery Energy | | $T_j = 25^\circ\text{C}$ | 0.34 | | mJ |
| | | | $T_j = 150^\circ\text{C}$ | 0.75 | | |

Temperature sensor NTC (see application note APT0406 on www.microsemi.com for more information).

| Symbol | Characteristic | Min | Typ | Max | Unit |
|--------------------|----------------------------|-----|------|-----|------|
| R ₂₅ | Resistance @ 25°C | | 50 | | kΩ |
| B _{25/85} | T ₂₅ = 298.15 K | | 3952 | | K |

$$R_T = \frac{R_{25}}{\exp\left[B_{25/85}\left(\frac{1}{T_{25}} - \frac{1}{T}\right)\right]}$$

T: Thermistor temperature
 R_T: Thermistor value at T

Thermal and package characteristics

| Symbol | Characteristic | Min | Typ | Max | Unit | | |
|-------------------|--|-------|-------------|------|------|-----|-----|
| R _{thJC} | Junction to Case Thermal Resistance | IGBT | | 1.6 | °C/W | | |
| | | Diode | | 2.45 | | | |
| V _{ISOL} | RMS Isolation Voltage, any terminal to case t=1 min, I _{isol} <1mA, 50/60Hz | 2500 | | | V | | |
| T _J | Operating junction temperature range | -40 | | 175 | °C | | |
| T _{STG} | Storage Temperature Range | -40 | | 125 | | | |
| T _C | Operating Case Temperature | -40 | | 100 | | | |
| Torque | Mounting torque | | To heatsink | M4 | 2.5 | 4.7 | N.m |
| Wt | Package Weight | | | | | 110 | g |

SP3 Package outline (dimensions in mm)

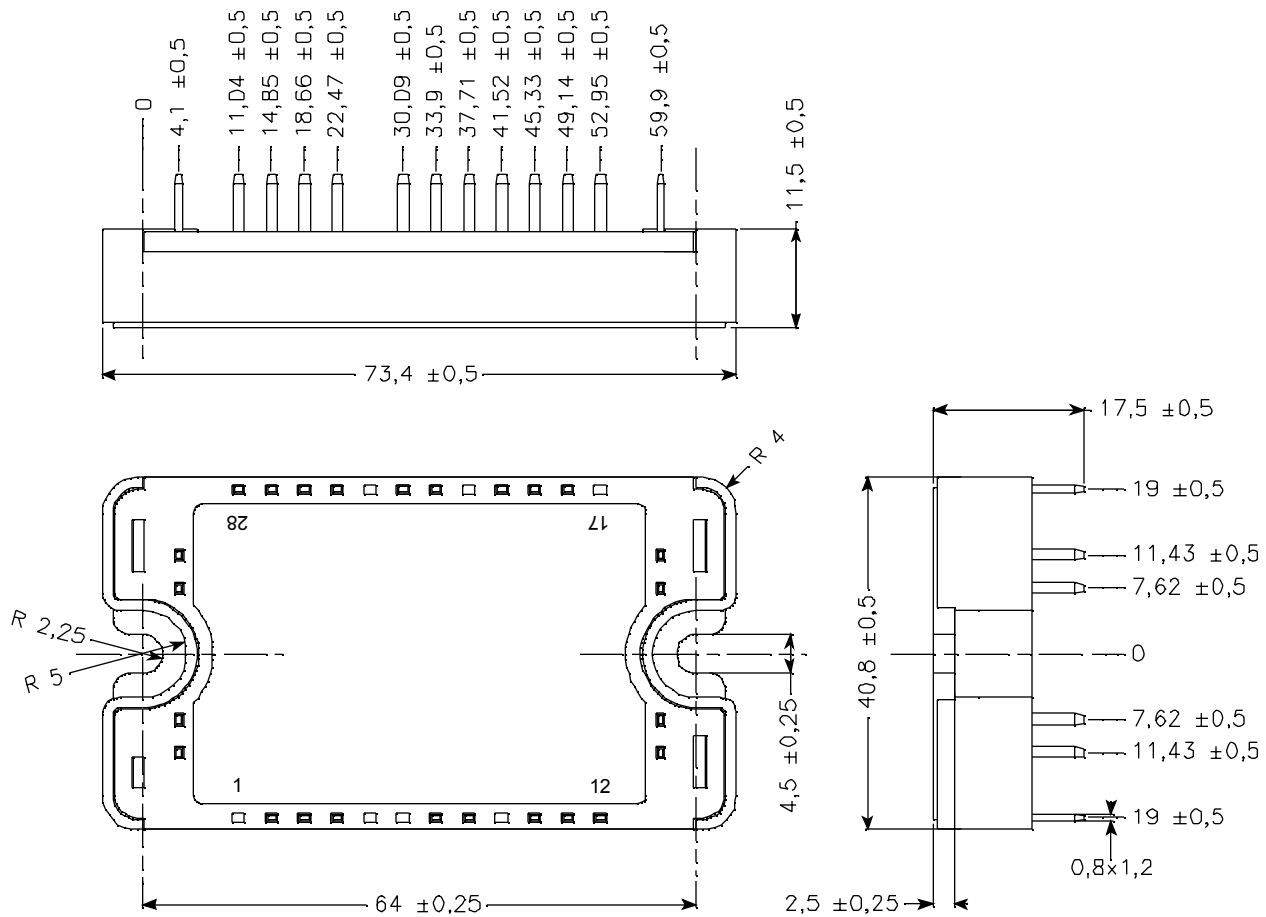

See application note 1901 - Mounting Instructions for SP3 Power Modules on www.microsemi.com

Typical Performance Curve

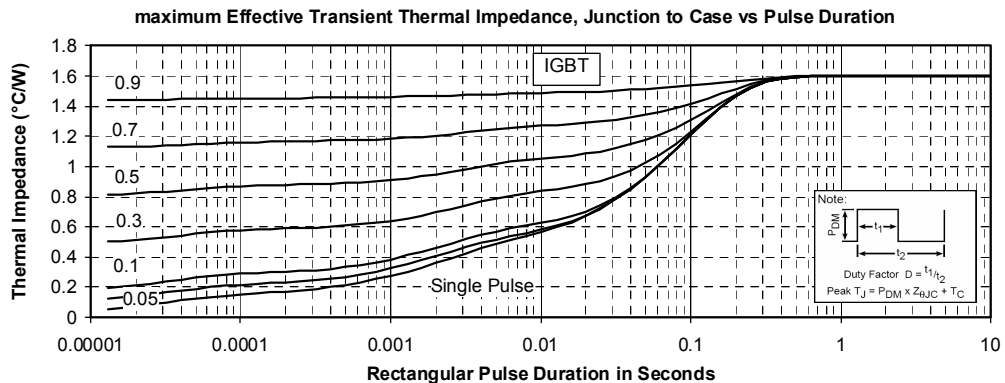
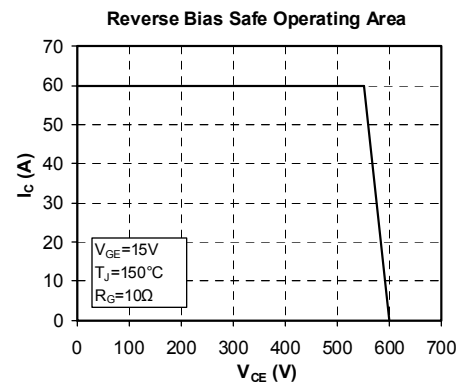
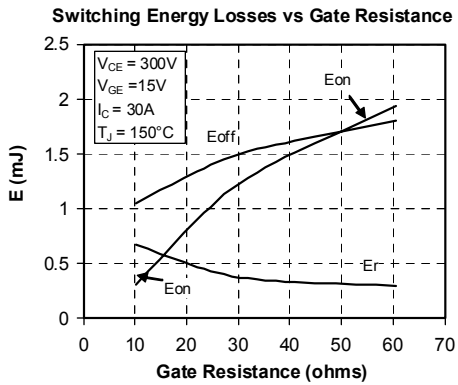
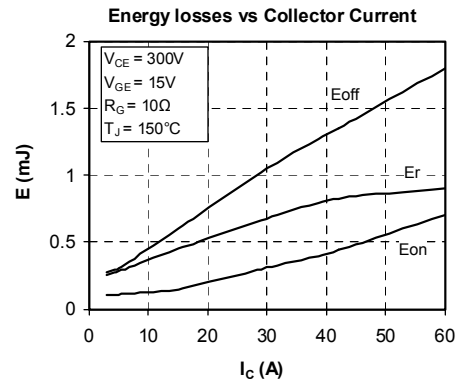
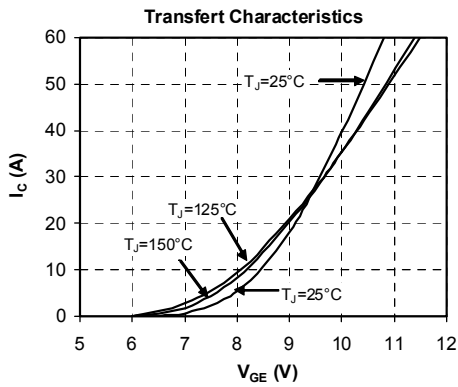
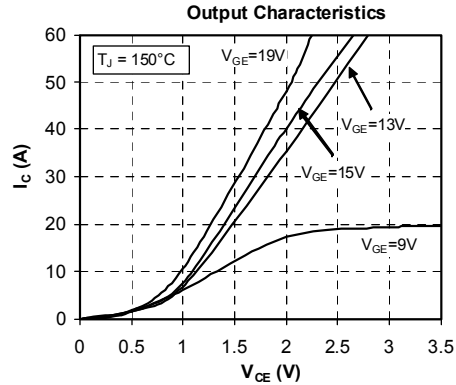
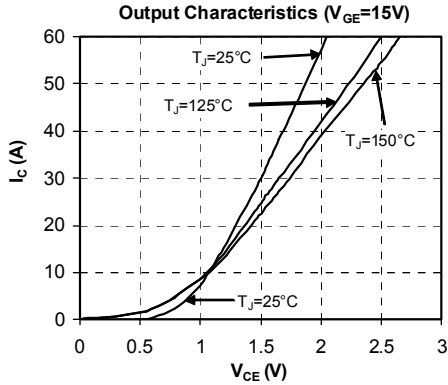

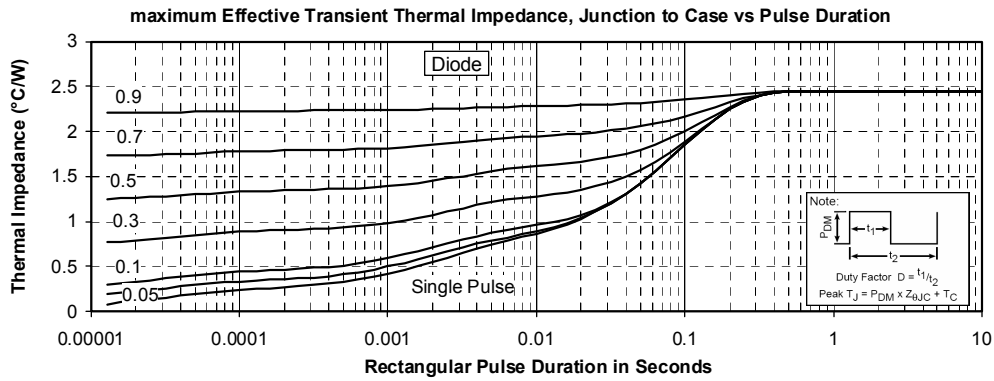
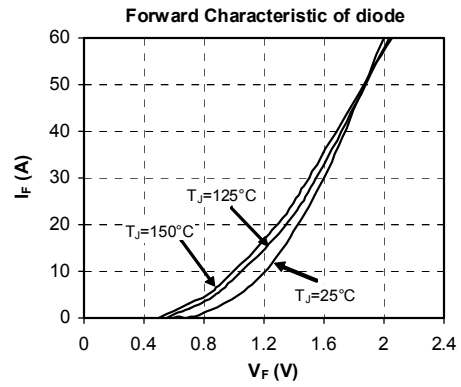
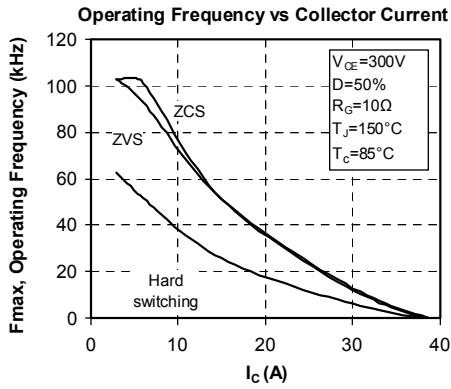

Microsemi reserves the right to change, without notice, the specifications and information contained herein

Microsemi's products are covered by one or more of U.S. patents 4,895,810 5,045,903 5,089,434 5,182,234 5,019,522 5,262,336 6,503,786 5,256,583 4,748,103 5,283,202 5,231,474 5,434,095 5,528,058 and foreign patents. U.S. and Foreign patents pending. All Rights Reserved.