

## 阅读申明

- 1.本站收集的数据手册和产品资料都来自互联网，版权归原作者所有。如读者和版权方有任何异议请及时告之，我们将妥善解决。
- 2.本站提供的中文数据手册是英文数据手册的中文翻译，其目的是协助用户阅读，该译文无法自动跟随原稿更新，同时也可能存在翻译上的不当。建议读者以英文原稿为参考以便获得更精准的信息。
- 3.本站提供的产品资料，来自厂商的技术支持或者使用者的心得体会等，其内容可能存在描述上的差异，建议读者做出适当判断。
- 4.如需与我们联系，请发邮件到marketing@iczoom.com，主题请标有“数据手册”字样。

## Read Statement

1. The datasheets and other product information on the site are all from network reference or other public materials, and the copyright belongs to the original author and original published source. If readers and copyright owners have any objections, please contact us and we will deal with it in a timely manner.
2. The Chinese datasheets provided on the website is a Chinese translation of the English datasheets. Its purpose is for reader's learning exchange only and do not involve commercial purposes. The translation cannot be automatically updated with the original manuscript, and there may also be improper translations. Readers are advised to use the English manuscript as a reference for more accurate information.
3. All product information provided on the website refer to solutions from manufacturers' technical support or users the contents may have differences in description, and readers are advised to take the original article as the standard.
4. If you have any questions, please contact us at marketing@iczoom.com and mark the subject with "Datasheets" .

# 2SJ0164 (2SJ164)

## Silicon P-channel junction FET

For switching circuits

Complementary to 2SK1104

### ■ Features

- Low ON resistance
- Low-noise characteristics

### ■ Absolute Maximum Ratings $T_a = 25^\circ\text{C}$

Parameter	Symbol	Rating	Unit
Gate-drain surrender voltage	$V_{\text{GDS}}$	65	V
Drain current	$I_{\text{D}}$	-20	mA
Gate current	$I_{\text{G}}$	-10	mA
Power dissipation	$P_{\text{D}}$	300	mW
Channel temperature	$T_{\text{ch}}$	150	$^\circ\text{C}$
Storage temperature	$T_{\text{stg}}$	-55 to +150	$^\circ\text{C}$

### ■ Package

- Code  
NS-A1
- Pin Name  
1: Source  
2: Gate  
3: Drain

### ■ Electrical Characteristics $T_a = 25^\circ\text{C} \pm 3^\circ\text{C}$

Parameter	Symbol	Conditions	Min	Typ	Max	Unit
Gate-drain surrender voltage	$V_{\text{GDS}}$	$I_{\text{G}} = 10 \mu\text{A}$ , $V_{\text{DS}} = 0$	65			V
Drain-source current *	$I_{\text{DSS}}$	$V_{\text{DS}} = -10 \text{ V}$ , $V_{\text{GS}} = 0$	-0.6		-6.0	mA
Gate-source cutoff current	$I_{\text{GSS}}$	$V_{\text{GS}} = 30 \text{ V}$ , $V_{\text{DS}} = 0$			10	nA
Gate-source cutoff voltage	$V_{\text{GS(off)}}$	$V_{\text{DS}} = -10 \text{ V}$ , $I_{\text{D}} = -10 \mu\text{A}$		1.5	3.5	V
Mutual conductance	$g_{\text{m}}$	$V_{\text{DS}} = -10 \text{ V}$ , $I_{\text{D}} = -1 \text{ mA}$ , $f = 1 \text{ kHz}$	1.8	2.5		mS
Short-circuit forward transfer capacitance (Common source)	$C_{\text{iss}}$	$V_{\text{DS}} = -10 \text{ V}$ , $V_{\text{GS}} = 0$ , $f = 1 \text{ MHz}$		10		pF
Reverse transfer capacitance (Common source)	$C_{\text{rss}}$			3		pF
Drain-source ON resistance	$R_{\text{DS(on)}}$	$V_{\text{DS}} = -10 \text{ mV}$ , $V_{\text{GS}} = 0$		300		$\Omega$

Note) 1. Measuring methods are based on JAPANESE INDUSTRIAL STANDARD JIS C 7030 measuring methods for transistors.

2. Observe precautions for handling. Electrostatic sensitive devices.

3. \*: Rank classification

Rank	P	Q	R
$I_{\text{DSS}}$ (mA)	-0.6 to -1.5	-1.0 to -3.0	-2.5 to -6.0

Note) The part number in the parenthesis shows conventional part number.

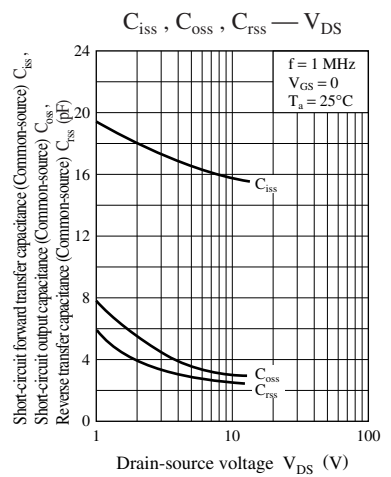
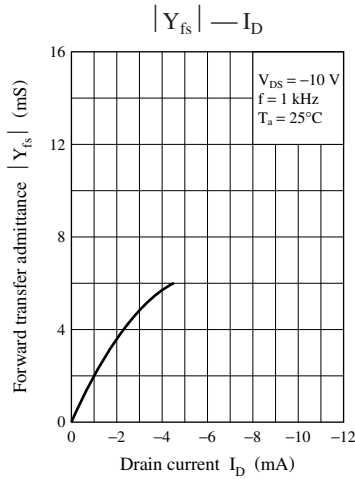
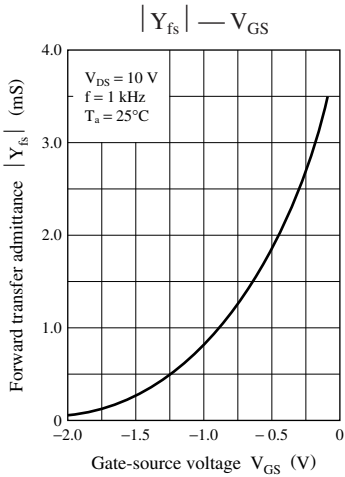
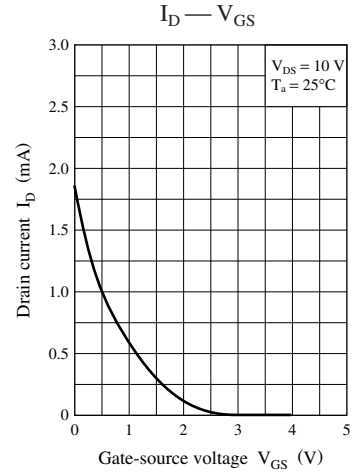
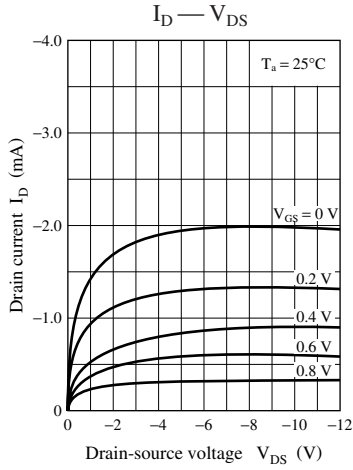
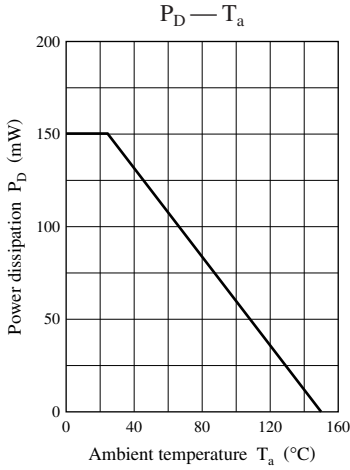

NS-A1

Unit: mm

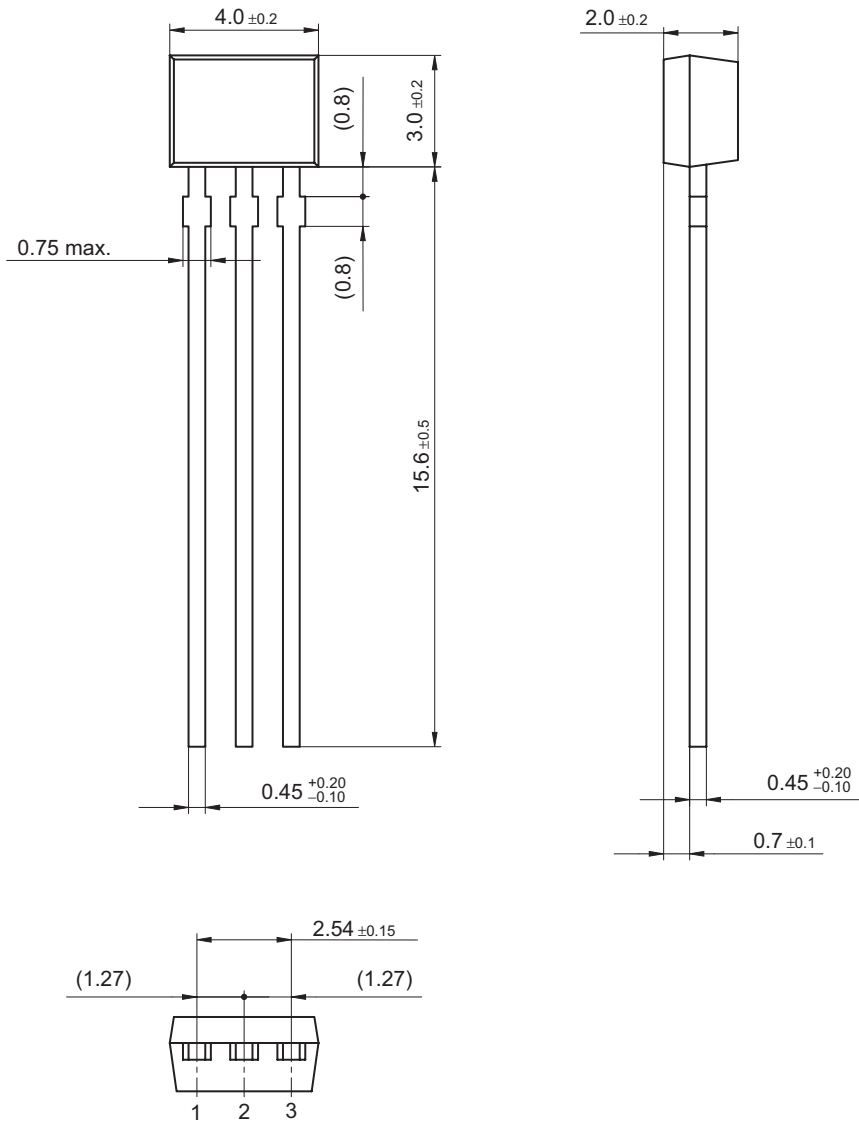

## Request for your special attention and precautions in using the technical information and semiconductors described in this book

- (1) If any of the products or technical information described in this book is to be exported or provided to non-residents, the laws and regulations of the exporting country, especially, those with regard to security export control, must be observed.
- (2) The technical information described in this book is intended only to show the main characteristics and application circuit examples of the products, and no license is granted under any intellectual property right or other right owned by our company or any other company. Therefore, no responsibility is assumed by our company as to the infringement upon any such right owned by any other company which may arise as a result of the use of technical information described in this book.
- (3) The products described in this book are intended to be used for standard applications or general electronic equipment (such as office equipment, communications equipment, measuring instruments and household appliances).  
Consult our sales staff in advance for information on the following applications:
  - Special applications (such as for airplanes, aerospace, automobiles, traffic control equipment, combustion equipment, life support systems and safety devices) in which exceptional quality and reliability are required, or if the failure or malfunction of the products may directly jeopardize life or harm the human body.
  - Any applications other than the standard applications intended.
- (4) The products and product specifications described in this book are subject to change without notice for modification and/or improvement. At the final stage of your design, purchasing, or use of the products, therefore, ask for the most up-to-date Product Standards in advance to make sure that the latest specifications satisfy your requirements.
- (5) When designing your equipment, comply with the range of absolute maximum rating and the guaranteed operating conditions (operating power supply voltage and operating environment etc.). Especially, please be careful not to exceed the range of absolute maximum rating on the transient state, such as power-on, power-off and mode-switching. Otherwise, we will not be liable for any defect which may arise later in your equipment.
  - Even when the products are used within the guaranteed values, take into the consideration of incidence of break down and failure mode, possible to occur to semiconductor products. Measures on the systems such as redundant design, arresting the spread of fire or preventing glitch are recommended in order to prevent physical injury, fire, social damages, for example, by using the products.
- (6) Comply with the instructions for use in order to prevent breakdown and characteristics change due to external factors (ESD, EOS, thermal stress and mechanical stress) at the time of handling, mounting or at customer's process. When using products for which damp-proof packing is required, satisfy the conditions, such as shelf life and the elapsed time since first opening the packages.
- (7) This book may be not reprinted or reproduced whether wholly or partially, without the prior written permission of Matsushita Electric Industrial Co., Ltd.