

## 阅读申明

- 1.本站收集的数据手册和产品资料都来自互联网，版权归原作者所有。如读者和版权方有任何异议请及时告之，我们将妥善解决。
- 2.本站提供的中文数据手册是英文数据手册的中文翻译，其目的是协助用户阅读，该译文无法自动跟随原稿更新，同时也可能存在翻译上的不当。建议读者以英文原稿为参考以便获得更精准的信息。
- 3.本站提供的产品资料，来自厂商的技术支持或者使用者的心得体会等，其内容可能存在描述上的差异，建议读者做出适当判断。
- 4.如需与我们联系，请发邮件到marketing@iczoom.com，主题请标有“数据手册”字样。

## Read Statement

1. The datasheets and other product information on the site are all from network reference or other public materials, and the copyright belongs to the original author and original published source. If readers and copyright owners have any objections, please contact us and we will deal with it in a timely manner.
2. The Chinese datasheets provided on the website is a Chinese translation of the English datasheets. Its purpose is for reader's learning exchange only and do not involve commercial purposes. The translation cannot be automatically updated with the original manuscript, and there may also be improper translations. Readers are advised to use the English manuscript as a reference for more accurate information.
3. All product information provided on the website refer to solutions from manufacturers' technical support or users the contents may have differences in description, and readers are advised to take the original article as the standard.
4. If you have any questions, please contact us at marketing@iczoom.com and mark the subject with "Datasheets" .

## Features

- GaN on SiC D-Mode Transistor Technology
- Unmatched, Ideal for Pulsed Applications
- 50 V Typical Bias, Class AB
- Common-Source Configuration
- Thermally-Enhanced 3 x 6 mm 14-Lead DFN
- MTTF = 600 years ( $T_J < 200^\circ\text{C}$ )
- Halogen-Free “Green” Mold Compound
- RoHS\* Compliant and 260°C Reflow Compatible
- MSL-1

## Description

The MAGX-000035-09000P is a GaN on SiC unmatched power device offering the widest RF frequency capability, most reliable high voltage operation, lowest overall power transistor size, cost and weight in a “TRUE SMT” plastic-packaging technology.

Use of an internal stress buffer technology allows reliable operation at junction temperatures up to 200°C. The small package size and excellent RF performance make it an ideal replacement for costly flanged or metal-backed module components.

## Ordering Information<sup>1,2</sup>

Part Number	Package
MAGX-000035-09000P	Bulk Packaging
MAGX-000035-0900TP	100 Piece Reel
MAGX-000035-PB3PPR	Sample Board

1. Reference Application Note M513 for reel size information.
2. When ordering sample evaluation boards, choose a standard frequency range indicated on page 4/5 or specify a desired custom range. Custom requests may increase lead times.

\* Restrictions on Hazardous Substances, European Union Directive 2002/95/EC.

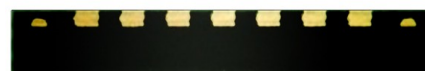

## Functional Schematic

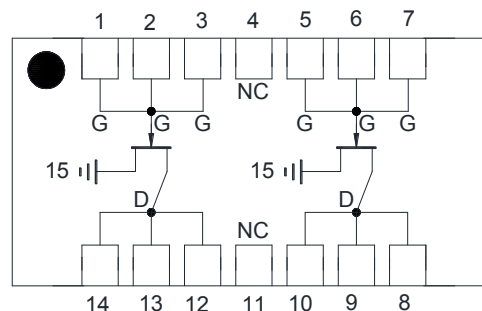

## Pin Configuration<sup>3</sup>

Pin No.	Function	Pin No.	Function
1	$V_{GG}/RF_{IN}$	8	$V_{DD}/RF_{OUT}$
2	$V_{GG}/RF_{IN}$	9	$V_{DD}/RF_{OUT}$
3	$V_{GG}/RF_{IN}$	10	$V_{DD}/RF_{OUT}$
4	No Connection	11	No Connection
5	$V_{GG}/RF_{IN}$	12	$V_{DD}/RF_{OUT}$
6	$V_{GG}/RF_{IN}$	13	$V_{DD}/RF_{OUT}$
7	$V_{GG}/RF_{IN}$	14	$V_{DD}/RF_{OUT}$
		15	Paddle <sup>4</sup>

3. MACOM recommends connecting unused package pins to ground.
4. The exposed pad centered on the package bottom must be connected to RF and DC ground.

## GaN Wideband 90 W Pulsed Transistor in Plastic Package DC - 3.5 GHz

Rev. V3

### Typical Performance<sup>5</sup>: $V_{DD} = 50\text{ V}$ , $I_{DQ} = 200\text{ mA}$ , $T_A = 25^\circ\text{C}$

Parameter	30 MHz	1 GHz	2.5 GHz	3.5 GHz	Units
Gain	25	21	15	13	dB
Saturated Power ( $P_{SAT}$ )	100	98	90	85	W
Power Gain at $P_{SAT}$	22	20	15	11	dB
PAE @ $P_{SAT}$	75	65	55	52	%

5. Typical RF performance measured in M/A-COM Technology Solutions RF evaluation boards. See recommended tuning solutions on pages 4 and 5.

### Electrical Specifications: Freq. = 1.6 GHz, $T_A = 25^\circ\text{C}$ , $V_{DD} = +50\text{ V}$ , $Z_0 = 50\ \Omega$

Parameter	Test Conditions	Symbol	Min.	Typ.	Max.	Units
<b>RF FUNCTIONAL TESTS</b>						
CW Output Power (P2.5 dB)	$V_{DD} = 28\text{ V}$ , $I_{DQ} = 200\text{ mA}$	$P_{OUT}$	-	14	-	W
Pulsed Output Power (P2.5 dB) 100 $\mu\text{s}$ and 10% Duty Cycle	$V_{DD} = 50\text{ V}$ , $I_{DQ} = 200\text{ mA}$	$P_{OUT}$	75	95	-	W
Pulsed Power Gain (P2.5 dB)	$V_{DD} = 50\text{ V}$ , $I_{DQ} = 200\text{ mA}$	$G_P$	16	17.5	-	dB
Pulsed Drain Efficiency (P2.5 dB)	$V_{DD} = 50\text{ V}$ , $I_{DQ} = 200\text{ mA}$	$\eta_D$	55	65	-	%
Load Mismatch Stability (P2.5 dB)	$V_{DD} = 50\text{ V}$ , $I_{DQ} = 200\text{ mA}$	VSWR-S	-	5:1	-	-
Load Mismatch Tolerance (P2.5 dB)	$V_{DD} = 50\text{ V}$ , $I_{DQ} = 200\text{ mA}$	VSWR-T	-	10:1	-	-

### Electrical Characteristics: $T_A = 25^\circ\text{C}$

Parameter	Test Conditions	Symbol	Min.	Typ.	Max.	Units
<b>DC CHARACTERISTICS</b>						
Drain-Source Leakage Current	$V_{GS} = -8\text{ V}$ , $V_{DS} = 175\text{ V}$	$I_{DS}$	-	-	6.0	mA
Gate Threshold Voltage	$V_{DS} = 5\text{ V}$ , $I_D = 6\text{ mA}$	$V_{GS(th)}$	-5	-3	-2	V
Forward Transconductance	$V_{DS} = 5\text{ V}$ , $I_D = 3000\text{ mA}$	$G_M$	1.1	-	-	S
<b>DYNAMIC CHARACTERISTICS</b>						
Input Capacitance	$V_{DS} = 0\text{ V}$ , $V_{GS} = -8\text{ V}$ , $F = 1\text{ MHz}$	$C_{ISS}$	-	22	-	pF
Output Capacitance	$V_{DS} = 50\text{ V}$ , $V_{GS} = -8\text{ V}$ , $F = 1\text{ MHz}$	$C_{OSS}$	-	9.8	-	pF
Reverse Transfer Capacitance	$V_{DS} = 50\text{ V}$ , $V_{GS} = -8\text{ V}$ , $F = 1\text{ MHz}$	$C_{RSS}$	-	0.9	-	pF

2

M/A-COM Technology Solutions Inc. (MACOM) and its affiliates reserve the right to make changes to the product(s) or information contained herein without notice. Visit [www.macomtech.com](http://www.macomtech.com) for additional data sheets and product information.

For further information and support please visit:  
<https://www.macomtech.com/content/customersupport>

Absolute Maximum Ratings<sup>6,7,8,9,10</sup>

Parameter	Absolute Max.
Input Power	$P_{OUT} - G_P + 2.5 \text{ dBm}$
Drain Supply Voltage, $V_{DD}$	+65 V
Gate Supply Voltage, $V_{GG}$	-8 V to 0 V
Supply Current, $I_{DD}$	4500 mA
Power Dissipation, CW @ 85°C	27 W
Power Dissipation ( $P_{AVG}$ ), Pulsed @ 85°C	85 W
Junction Temperature <sup>11</sup>	200°C
Operating Temperature	-40°C to +95°C
Storage Temperature	-65°C to +150°C

6. Exceeding any one or combination of these limits may cause permanent damage to this device.
7. M/A-COM Technology Solutions does not recommend sustained operation near these survivability limits.
8. For saturated performance it is recommended that the sum of  $(3 * V_{DD} + \text{abs}(V_{GG})) \leq 175 \text{ V}$ .
9. CW operation at  $V_{DD}$  voltages above 28 V is not recommended.
10. Operating at nominal conditions with  $T_J \leq 200^\circ\text{C}$  will ensure  $\text{MTTF} > 1 \times 10^6$  hours. Junction temperature directly affects device MTTF and should be kept as low as possible to maximize lifetime.
11. Junction Temperature ( $T_J$ ) =  $T_C + \Theta_{JC} * ((V * I) - (P_{OUT} - P_{IN}))$

Typical CW thermal resistance ( $\Theta_{JC}$ ) = 5.69°C/W

a) For  $T_C = 79^\circ\text{C}$ ,

$T_J = 200^\circ\text{C}$  @ 28 V, 1224 mA,  $P_{OUT} = 15 \text{ W}$ ,  $P_{IN} = 0.25 \text{ W}$

Typical transient thermal resistances:

b) 300  $\mu\text{s}$  pulse, 10% duty cycle,  $\Theta_{JC} = 0.96^\circ\text{C/W}$

For  $T_C = 79^\circ\text{C}$ ,

$T_J = 131^\circ\text{C}$  @ 50 V, 2500 mA,  $P_{OUT} = 74 \text{ W}$ ,  $P_{IN} = 2 \text{ W}$

c) 1 ms pulse, 10% duty cycle,  $\Theta_{JC} = 1.38^\circ\text{C/W}$

For  $T_C = 80^\circ\text{C}$ ,

$T_J = 173^\circ\text{C}$  @ 50 V, 2780 mA,  $P_{OUT} = 74 \text{ W}$ ,  $P_{IN} = 2 \text{ W}$

d) 1 ms pulse, 10% duty cycle,  $\Theta_{JC} = 1.35^\circ\text{C/W}$

For  $T_C = 80^\circ\text{C}$ ,

$T_J = 173^\circ\text{C}$  @ 50 V, 3160 mA,  $P_{OUT} = 93 \text{ W}$ ,  $P_{IN} = 4 \text{ W}$

## Evaluation Board Details and Recommended Tuning Solutions

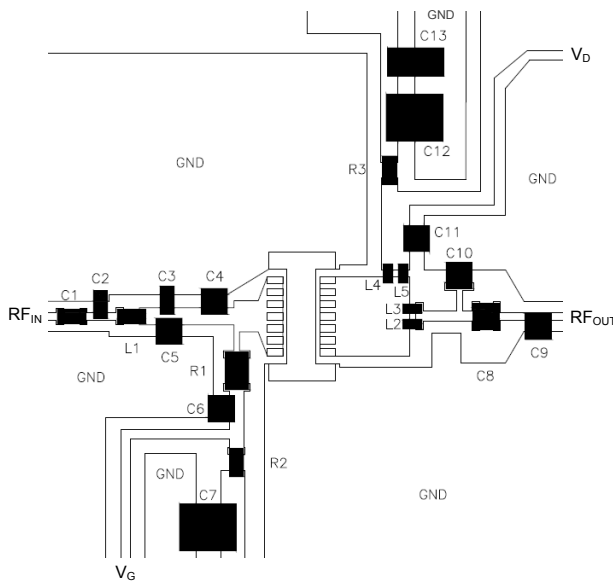

Parts measured on evaluation board (8-mils thick RO4003C). Electrical and thermal ground is provided using copper-filled via hole array (not pictured), and evaluation board is mounted to a metal plate.

Matching is provided using lumped elements as shown at left. Recommended tuning solutions for 2 frequency ranges are detailed in the parts list below.

### Bias Sequencing

#### Turning the device ON

1. Set  $V_G$  to the pinch-off ( $V_P$ ), typically -5 V.
2. Turn on  $V_D$  to nominal voltage (50 V).
3. Increase  $V_{GS}$  until the  $I_{DS}$  current is reached.
4. Apply RF power to desired level.

#### Turning the device OFF

1. Turn the RF power off.
2. Decrease  $V_G$  down to  $V_P$ .
3. Decrease  $V_D$  down to 0 V.
4. Turn off  $V_G$ .

### Parts List

(N/A = not applicable for this tuning solution)

Part	Frequency = 1.2 - 1.4 GHz	Frequency = 1.6 GHz
C1	0505, 56 pF, $\pm 5\%$ , 250 V, ATC	0505, 36 pF, $\pm 5\%$ , 250 V, ATC
C2	0603, 4.7 pF, $\pm 0.1$ pF, 250 V, ATC	N/A
C3	0603, 10 pF, $\pm 5\%$ , 250 V, ATC	N/A
C4	0505, 15 pF, $\pm 5\%$ , 250 V, ATC	N/A
C5	N/A	0505, 8.2 pF, $\pm 0.1$ pF, 250 V, ATC
C6	N/A	0505, 100 pF, $\pm 10\%$ , 200 V, ATC
C7	0805, 1000 pF, 100 V, 5%, AVX	0805, 1000 pF, 100 V, 5%, AVX
C8	0505, 56 pF, $\pm 5\%$ , 250 V, ATC	0505, 36 pF, $\pm 5\%$ , 250 V, ATC
C9	0505, 2.2 pF, $\pm 0.1$ pF, 250 V, ATC	0505, 3.0 pF, $\pm 0.1$ pF, 250 V, ATC
C10	0505, 1.0 pF, $\pm 0.1$ pF, 250 V, ATC	N/A
C11	0505, 91 pF, $\pm 5\%$ , 250 V, ATC	0505, 36 pF, $\pm 5\%$ , 250 V, ATC
C12	0805, 1000 pF, 100 V, 5%, AVX	0805, 1000 pF, 100 V, 5%, AVX
C13	1210, 1 $\mu$ F, 100 V, 20%, ATC	1210, 1 $\mu$ F, 100 V, 20%, ATC
R1	12 $\Omega$ , 0805, 5%	12 $\Omega$ , 0805, 5%
R2	1.0 $\Omega$ , 0603, 5%	1.0 $\Omega$ , 0603, 5%
R3	0.33 $\Omega$ , 0603, 5%	1.0 $\Omega$ , 0603, 5%
L1	0603 CS, 1.6 nH (1.8 nH)	N/A
L2	0402 HP, 2.7 nH	N/A
L3	0402 HP, 2.7 nH	N/A
L4	0402 PA, 1.9 nH (0402 HP, 2.0 nH)	N/A
L5	0402 PA, 1.9 nH (0402 HP, 2.0 nH)	N/A

4

MACOM Technology Solutions Inc. (MACOM) and its affiliates reserve the right to make changes to the product(s) or information contained herein without notice. Visit [www.macomtech.com](http://www.macomtech.com) for additional data sheets and product information.

## Evaluation Board Details and Recommended Tuning Solutions (Freq. = 2.7 - 3.5 GHz)

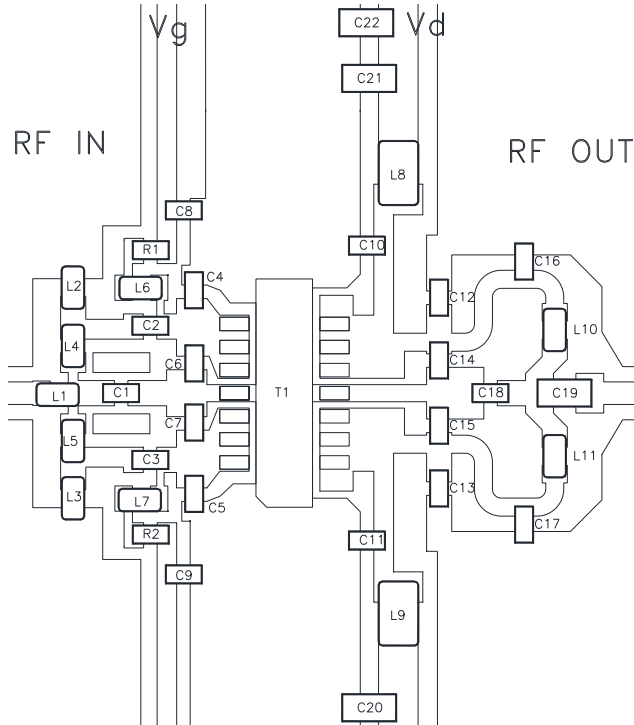

Parts measured on evaluation board (12-mil thick RO4003C). Electrical and thermal ground is provided using a copper-filled via hole array (not pictured), and evaluation board is mounted to a metal plate.

Matching is provided using lumped elements. Recommended tuning solutions for 1 frequency range is detailed in the parts list below.

### Parts List

Part	Value	Case Style
C1	0.7 pF	0402
C2, C3	1.1 pF	0402
C4, C5, C6, C7	2.0 pF	0402
C8, C9	100 pF	0402
C10, C11	6.8 pF	0402
C12, C13, C14, C15	1.3 pF	0402
C16, C17	0.3 pF	0402
C18	0.5 pF	0402
C19	12 pF	0603
C20, C21	100 pF	0603
C22	10 nF	0603
L1, L2, L3, L10, L11	1 nH	0402
L6, L7	12 nH	0402
L8, L9	12 nH	0603
L4, L5	2.2 nH	0402
R1, R2	200 Ω	0402
T1	MAGX-000035-09000P	3x6 mm DFN

### Bias Sequencing

#### Turning the device ON

1. Set  $V_G$  to the pinch-off ( $V_P$ ), typically -5 V.
2. Turn on  $V_D$  to nominal voltage (50 V).
3. Increase  $V_{GS}$  until the  $I_{DS}$  current is reached.
4. Apply RF power to desired level.

#### Turning the device OFF

1. Turn the RF power off.
2. Decrease  $V_G$  down to  $V_P$ .
3. Decrease  $V_D$  down to 0 V.
4. Turn off  $V_G$ .

**Lead-Free 3x6 mm 14-Lead DFN<sup>†</sup>**

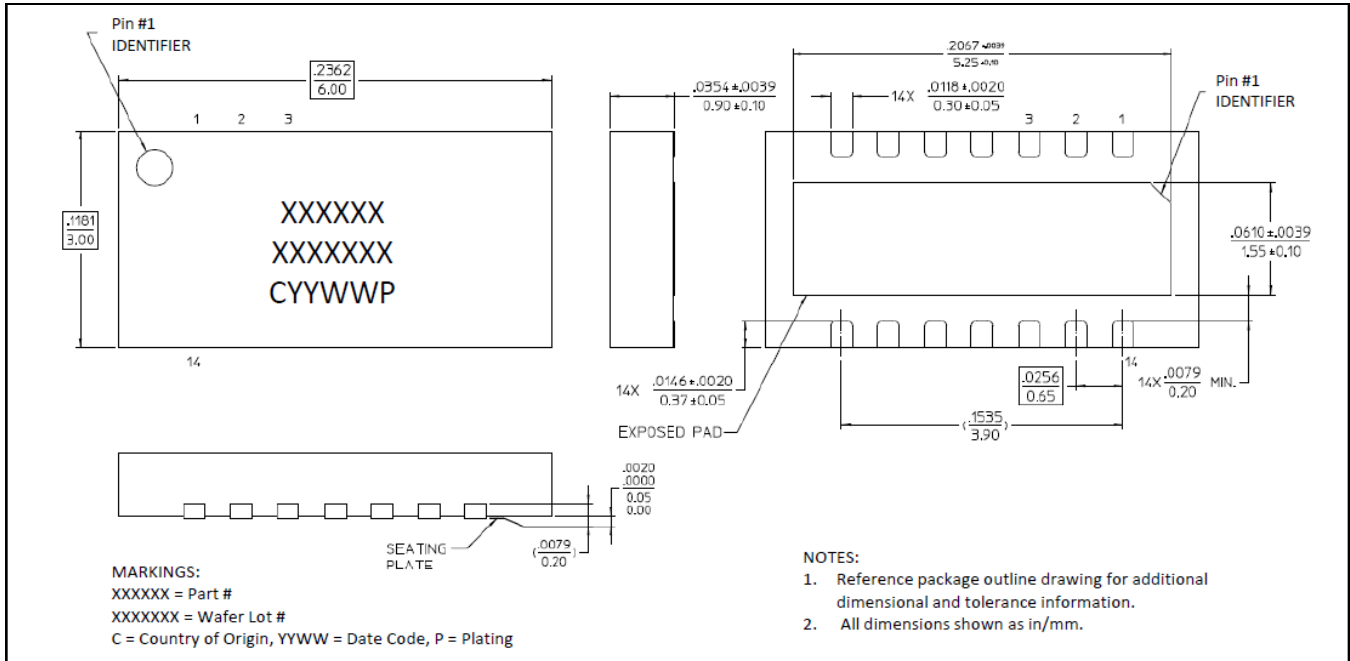

<sup>†</sup> Reference Application Note S2083 for lead-free solder reflow recommendations.  
 Meets JEDEC moisture sensitivity level 1 requirements.  
 Plating is Ni/Pd/Au.

## Handling Procedures

Please observe the following precautions to avoid damage:

## Static Sensitivity

Gallium Nitride Devices and Circuits are sensitive to electrostatic discharge (ESD) and can be damaged by static electricity. Proper ESD control techniques should be used when handling these Class 1B devices.

## Applications Section

S-Parameter Data:  $T_A = 25^\circ\text{C}$ ,  $V_{DD} = +50\text{ V}$ ,  $I_{DQ} = 200\text{ mA}$

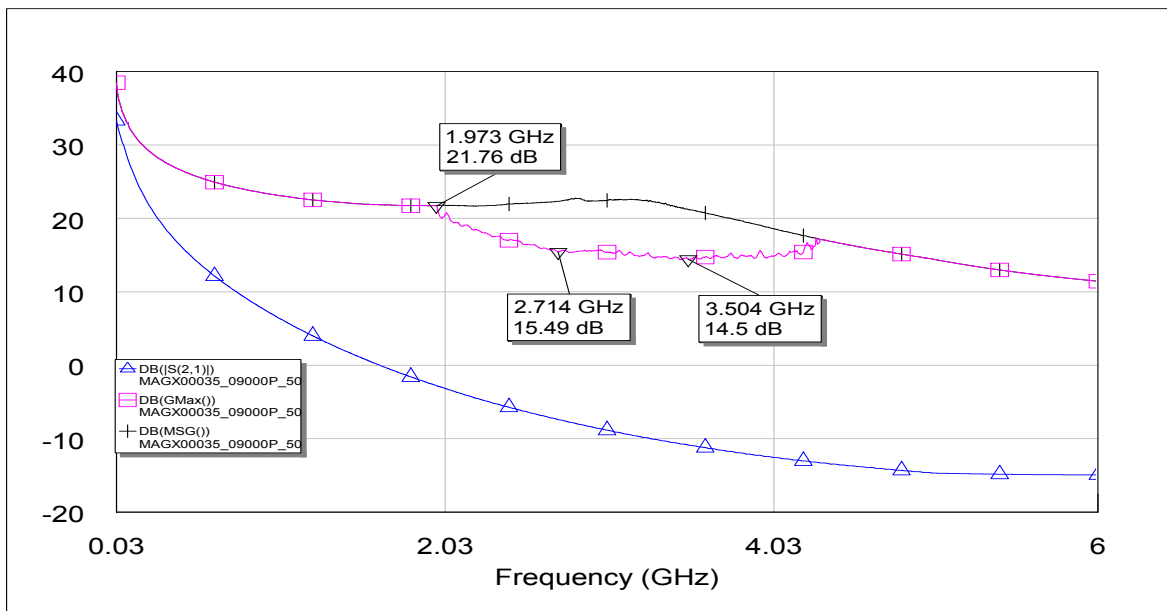
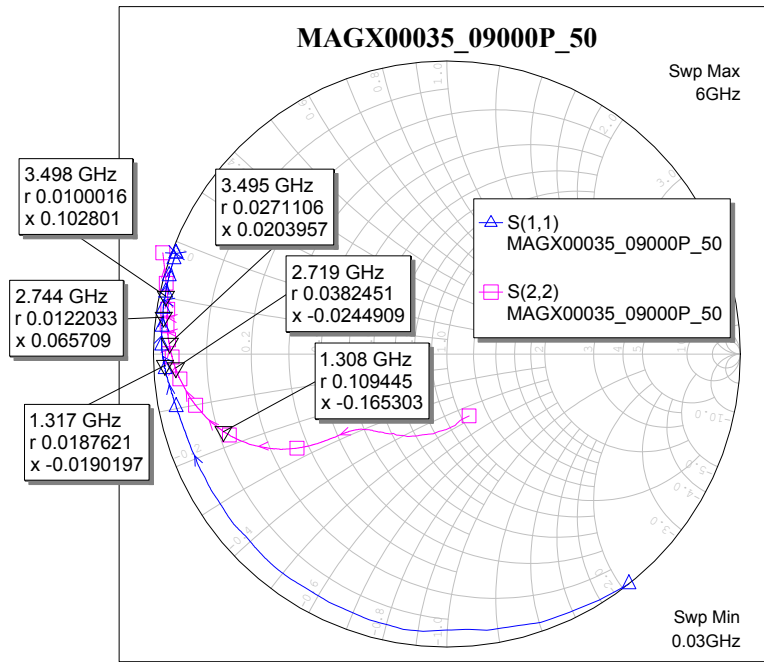



## Applications Section

**Thermal Performance: Freq. = 1.6 GHz,  $T_C = 85^\circ\text{C}$ ,  $V_{DD} = +50\text{ V}$ ,  $I_{DQ} = 100\text{ mA}$ ,  $Z_0 = 50\ \Omega$**

**Power (Output & Dissipated) vs. Transient Junction Temperature, Pulse Duration and Duty Cycle**

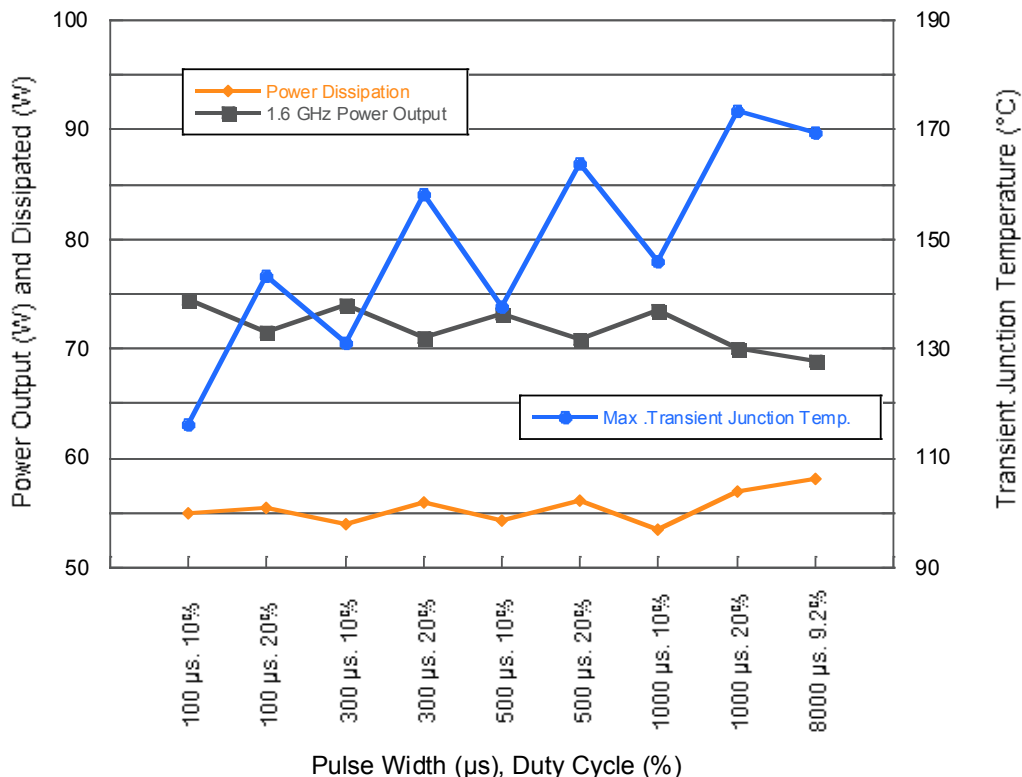

Pulse Width, Duty Cycle	100 μs, 10%	100 μs, 20%	300 μs, 10%	300 μs, 20%	500 μs, 10%	500 μs, 20%	1000 μs, 10%	1000 μs, 20%	8000 μs, 9.2%
Power Dissipation (W)	55	55.4	54	55.9	54.3	56.2	53.5	57	58.2
1.6 GHz P <sub>OUT</sub> (W)	74.5	71.6	74	71.1	73.2	70.8	73.5	70	68.8
Max. Transient Junction Temp. (°C)	116.3	143.4	131.0	158.2	137.6	164.0	146.0	173.4	169.4

Junction temperature measured using High-Speed Transient (HST) temperature detection microscopy.

## Applications Section

Typical Performance Curves (reference 1.2 - 1.4 GHz parts list):

1.2 - 1.4 GHz, 3 ms Pulse, 10% Duty Cycle,  $V_{DD} = +50\text{ V}$ ,  $T_A = 25^\circ\text{C}$ ,  $Z_0 = 50\ \Omega$

**Gain vs. Input Power**

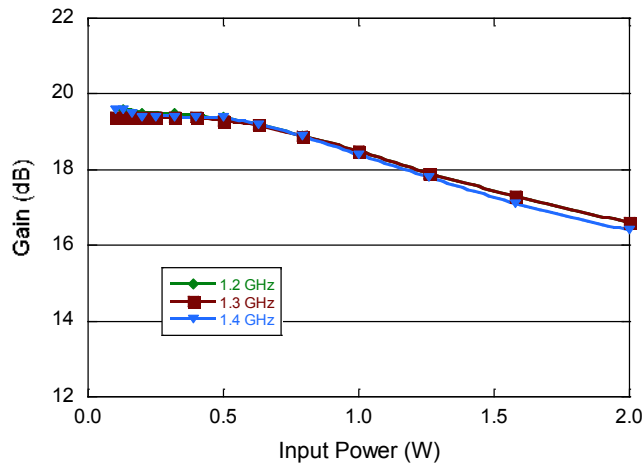

**Output Power vs. Input Power**

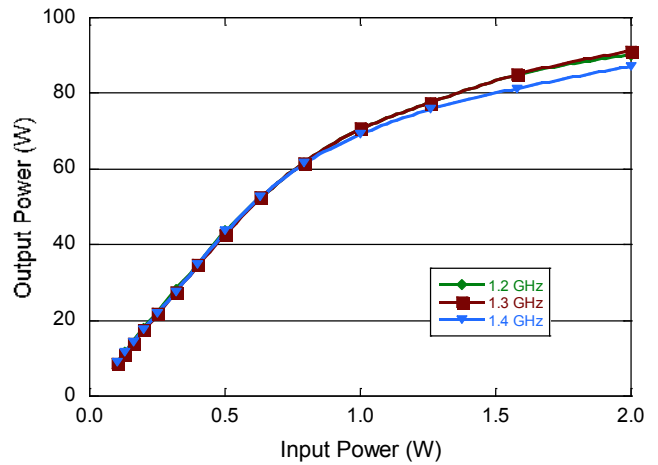

**PAE vs. Input Power**

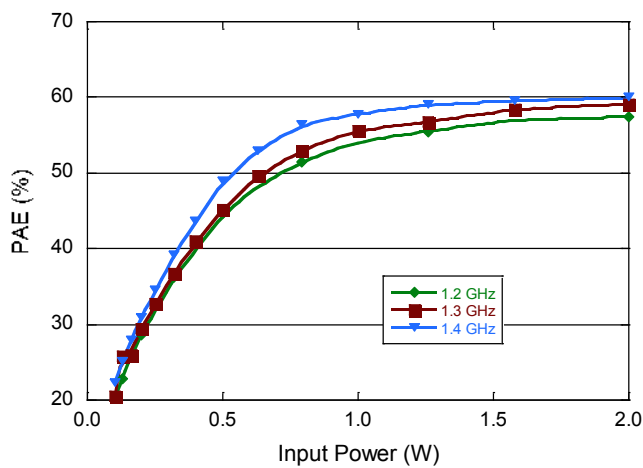

## Applications Section

Typical Performance Curves (reference 1.6 GHz parts list):

1.6 GHz, 1 ms Pulse, 10% Duty Cycle,  $V_{DD} = +50\text{ V}$ ,  $T_A = 25^\circ\text{C}$ ,  $Z_0 = 50\ \Omega$

Gain vs. Input Power

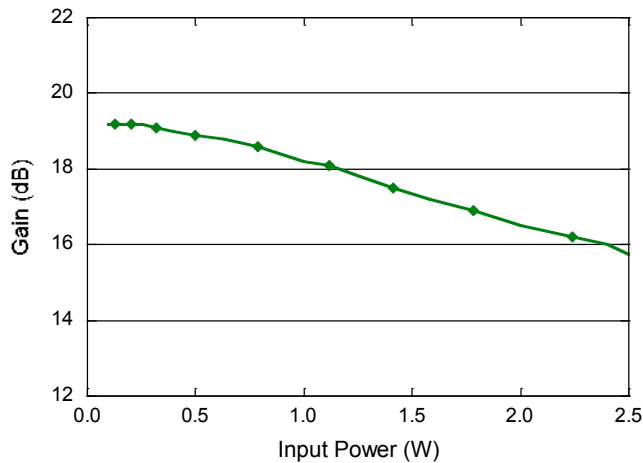

Output Power vs. Input Power

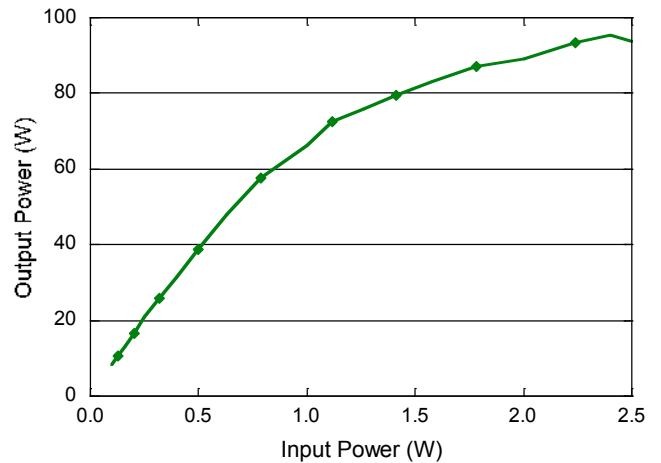

PAE vs. Input Power

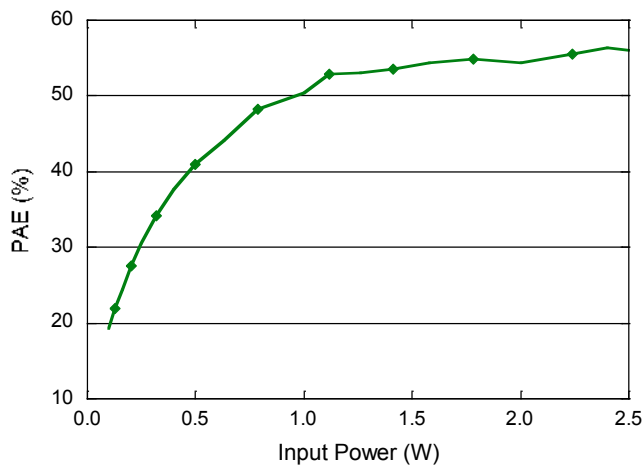

## Applications Section

Typical Performance Curves (reference 2.7 - 3.1 GHz parts list):

2.7 - 3.1 GHz, 1 ms Pulse, 10% Duty Cycle,  $V_{DD} = +50\text{ V}$ ,  $T_A = 25^\circ\text{C}$ ,  $Z_0 = 50\ \Omega$

**Gain vs. Frequency**

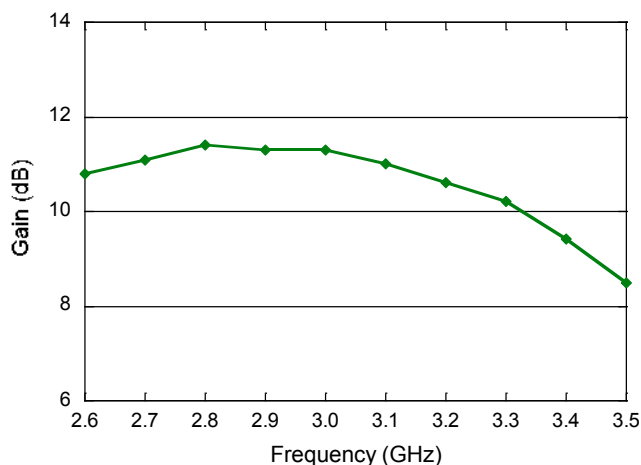

**Output Power vs. Frequency**

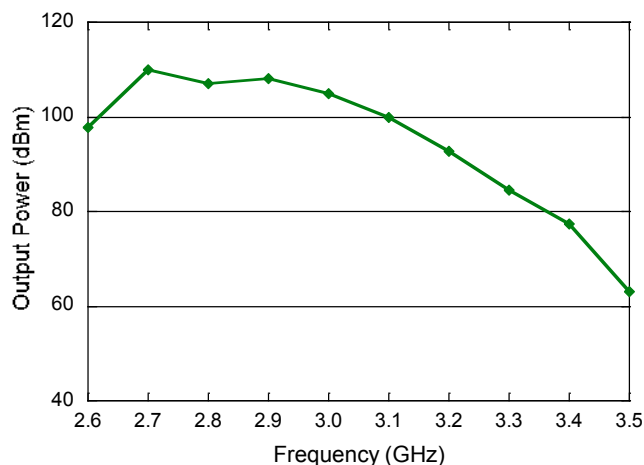

**PAE vs. Frequency**

