

阅读申明

- 1.本站收集的数据手册和产品资料都来自互联网，版权归原作者所有。如读者和版权方有任何异议请及时告之，我们将妥善解决。
- 2.本站提供的中文数据手册是英文数据手册的中文翻译，其目的是协助用户阅读，该译文无法自动跟随原稿更新，同时也可能存在翻译上的不当。建议读者以英文原稿为参考以便获得更精准的信息。
- 3.本站提供的产品资料，来自厂商的技术支持或者使用者的心得体会等，其内容可能存在描述上的差异，建议读者做出适当判断。
- 4.如需与我们联系，请发邮件到marketing@iczoom.com，主题请标有“数据手册”字样。

Read Statement

1. The datasheets and other product information on the site are all from network reference or other public materials, and the copyright belongs to the original author and original published source. If readers and copyright owners have any objections, please contact us and we will deal with it in a timely manner.
2. The Chinese datasheets provided on the website is a Chinese translation of the English datasheets. Its purpose is for reader's learning exchange only and do not involve commercial purposes. The translation cannot be automatically updated with the original manuscript, and there may also be improper translations. Readers are advised to use the English manuscript as a reference for more accurate information.
3. All product information provided on the website refer to solutions from manufacturers' technical support or users the contents may have differences in description, and readers are advised to take the original article as the standard.
4. If you have any questions, please contact us at marketing@iczoom.com and mark the subject with "Datasheets" .

PNP SILICON PLANAR MEDIUM POWER DARLINGTON TRANSISTORS

ZTX704
ZTX705

ISSUE 3 – MAY 94

FEATURES

- * 120 Volt V_{CE0}
- * 1 Amp continuous current
- * Gain of 3K at $I_C=1$ Amp
- * $P_{tot}=1$ Watt

APPLICATIONS

- * Lamp, solenoid and relay drivers

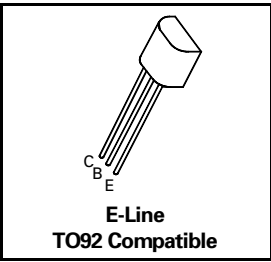

ABSOLUTE MAXIMUM RATINGS.

PARAMETER	SYMBOL	ZTX704	ZTX705	UNIT
Collector-Base Voltage	V_{CBO}	-120	-140	V
Collector-Emitter Voltage	V_{CEO}	-100	-120	V
Emitter-Base Voltage	V_{EBO}	-10		V
Peak Pulse Current	I_{CM}	-4		A
Continuous Collector Current	I_C	-1		A
Power Dissipation at $T_{amb} = 25^\circ\text{C}$ derate above 25°C	P_{tot}	1 5.7		W mW/°C
Operating and Storage Temperature Range	$T_j; T_{stg}$	-55 to +200		°C

ELECTRICAL CHARACTERISTICS (at $T_{amb} = 25^\circ\text{C}$ unless otherwise stated).

PARAMETER	SYMBOL	ZTX704		ZTX705		UNIT	CONDITIONS.
		MIN.	MAX.	MIN.	MAX.		
Collector-Base Breakdown Voltage	$V_{(BR)CBO}$	-120		-140		V	$I_C=-100\mu\text{A}$
Collector-Emitter Breakdown Voltage	$V_{CEO(SUS)}$	-100		-120		V	$I_C=-10\text{mA}^*$
Emitter-Base Breakdown Voltage	$V_{(BR)EBO}$	-10		-10		V	$I_E=-100\mu\text{A}$
Collector Cut-Off Current	I_{CBO}		-0.1 -10		-0.1 -10	μA μA μA μA	$V_{CB}=-100\text{V}$ $V_{CB}=-120\text{V}$ $V_{CB}=-100\text{V}, T_{amb}=100^\circ\text{C}$ $V_{CB}=-120\text{V}, T_{amb}=100^\circ\text{C}$
Collector Cut-Off Current	I_{CES}		-10		-10	μA	$V_{CES}=-80\text{V}$
Emitter Cut-Off Current	I_{EBO}		-0.1		-0.1	μA	$V_{EB}=-8\text{V}$
Collector-Emitter Saturation Voltage	$V_{CE(sat)}$		-1.3 -2.5		-1.3 -2.5	V V	$I_C=-1\text{A}, I_B=-1\text{mA}^*$ $I_C=-2\text{A}, I_B=-2\text{mA}^*$
Base-Emitter Saturation Voltage	$V_{BE(sat)}$		-1.8		-1.8	V	$I_C=-1\text{A}, I_B=-10\text{mA}^*$
Base-Emitter Turn-On Voltage	$V_{BE(on)}$		-1.7		-1.7	V	$I_C=-1\text{A}, V_{CE}=-5\text{V}^*$

ZTX704 ZTX705

ELECTRICAL CHARACTERISTICS (at $T_{amb} = 25^{\circ}\text{C}$).

PARAMETER	SYMBOL	ZTX704		ZTX705		UNIT	CONDITIONS.
		MIN.	MAX.	MIN.	MAX.		
Static Forward Current Transfer Ratio	h_{FE}	3K 3K 3K 2K	30K	3K 3K 3K 2K	30K		$I_C = -10\text{mA}, V_{CE} = -5\text{V}^*$ $I_C = -100\text{mA}, V_{CE} = -5\text{V}^*$ $I_C = -1\text{A}, V_{CE} = -5\text{V}^*$ $I_C = -2\text{A}, V_{CE} = -5\text{V}^*$
Transition Frequency	f_T	160 Typical		160 Typical		MHz	$I_C = -100\text{mA}, V_{CE} = -10\text{V}$ $f = 20\text{MHz}$
Input Capacitance	C_{ibo}	90 Typical		90 Typical		pF	$V_{EB} = -0.5\text{V}, f = 1\text{MHz}$
Output Capacitance	C_{obo}	15 Typical		15 Typical		pF	$V_{CE} = -10\text{V}, f = 1\text{MHz}$
Switching Times	t_{on}	0.6 Typical		0.6 Typical		μs	$I_C = -0.5\text{A}, V_{CE} = -10\text{V}$ $I_{B1} = I_{B2} = -0.5\text{mA}$
	t_{off}	0.8 Typical		0.8 Typical		μs	

*Measured under pulsed conditions. Pulse width=300 μs . Duty cycle $\leq 2\%$

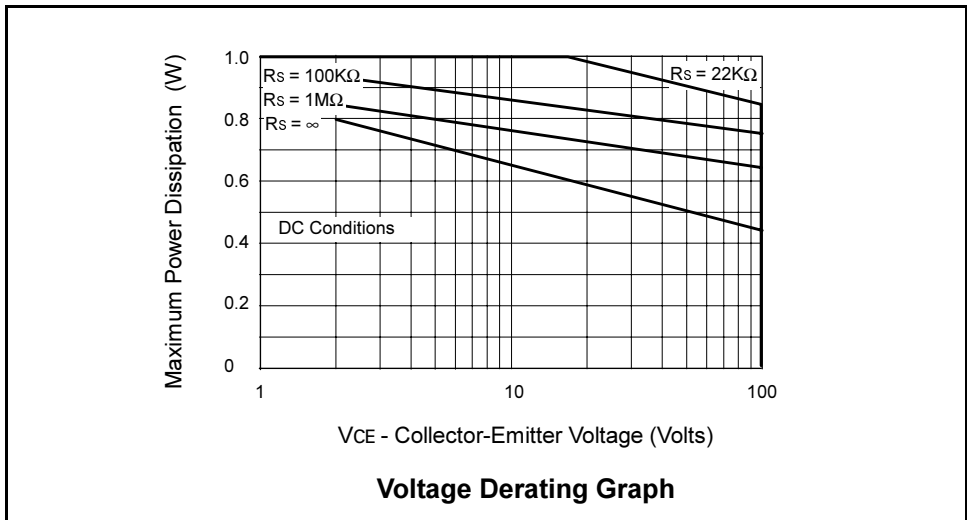

The maximum permissible operational temperature can be obtained from this graph using the following equation

$$T_{amb(max)} = \frac{Power(max) - Power(act)}{0.0057} + 25^{\circ}\text{C}$$

$T_{amb(max)}$ = Maximum operating ambient temperature

Power(max) = Maximum power dissipation figure, obtained from the above graph for a given V_{CE} and source resistance (R_S)

Power(actual) = Actual power dissipation in users circuit

ZTX704 ZTX705

TYPICAL CHARACTERISTICS

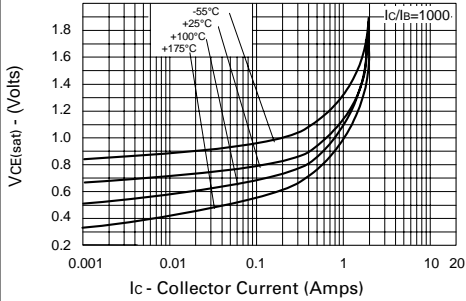

$V_{CE(sat)}$ v I_C

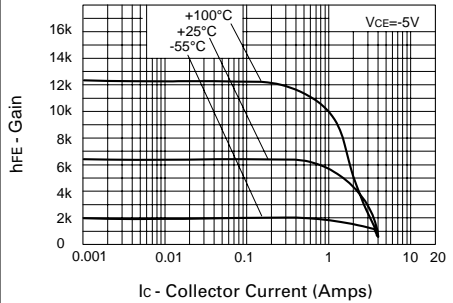

hFE v I_C

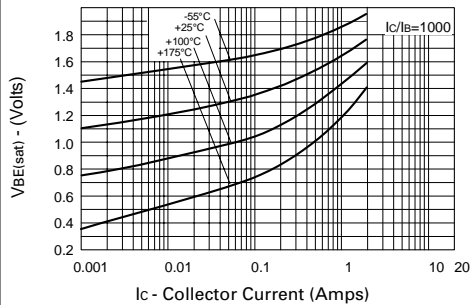

$V_{BE(sat)}$ v I_C

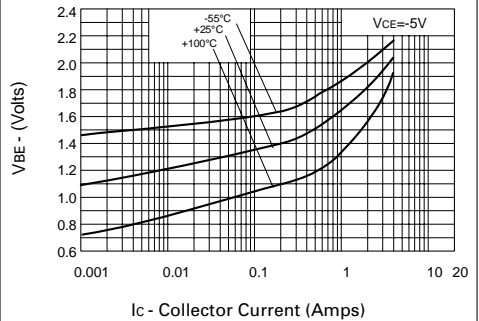

$V_{BE(on)}$ v I_C

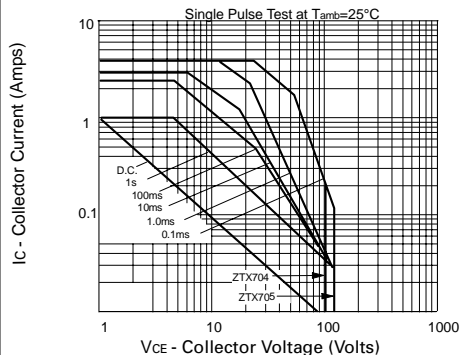

Safe Operating Area