

## 阅读申明

- 1.本站收集的数据手册和产品资料都来自互联网，版权归原作者所有。如读者和版权方有任何异议请及时告之，我们将妥善解决。
- 2.本站提供的中文数据手册是英文数据手册的中文翻译，其目的是协助用户阅读，该译文无法自动跟随原稿更新，同时也可能存在翻译上的不当。建议读者以英文原稿为参考以便获得更精准的信息。
- 3.本站提供的产品资料，来自厂商的技术支持或者使用者的心得体会等，其内容可能存在描述上的差异，建议读者做出适当判断。
- 4.如需与我们联系，请发邮件到marketing@iczoom.com，主题请标有“数据手册”字样。

## Read Statement

1. The datasheets and other product information on the site are all from network reference or other public materials, and the copyright belongs to the original author and original published source. If readers and copyright owners have any objections, please contact us and we will deal with it in a timely manner.
2. The Chinese datasheets provided on the website is a Chinese translation of the English datasheets. Its purpose is for reader's learning exchange only and do not involve commercial purposes. The translation cannot be automatically updated with the original manuscript, and there may also be improper translations. Readers are advised to use the English manuscript as a reference for more accurate information.
3. All product information provided on the website refer to solutions from manufacturers' technical support or users the contents may have differences in description, and readers are advised to take the original article as the standard.
4. If you have any questions, please contact us at marketing@iczoom.com and mark the subject with "Datasheets" .

# PN2907A

Preferred Device

## General Purpose Transistor

PNP Silicon



ON Semiconductor™

<http://onsemi.com>

### MAXIMUM RATINGS

Rating	Symbol	Value	Unit
Collector–Emitter Voltage	$V_{CEO}$	–60	Vdc
Collector–Base Voltage	$V_{CBO}$	–60	Vdc
Emitter–Base Voltage	$V_{EBO}$	–5.0	Vdc
Collector Current – Continuous	$I_C$	–600	mAdc
Total Device Dissipation @ $T_A = 25^\circ\text{C}$ Derate above $25^\circ\text{C}$	$P_D$	625 5.0	mW mW/ $^\circ\text{C}$
Total Device Dissipation @ $T_C = 25^\circ\text{C}$ Derate above $25^\circ\text{C}$	$P_D$	1.5 12	Watts mW/ $^\circ\text{C}$
Operating and Storage Junction Temperature Range	$T_J, T_{stg}$	–55 to +150	$^\circ\text{C}$

### THERMAL CHARACTERISTICS

Characteristic	Symbol	Max	Unit
Thermal Resistance, Junction to Ambient	$R_{\theta JA}$	200	$^\circ\text{C}/\text{W}$
Thermal Resistance, Junction to Case	$R_{\theta JC}$	83.3	$^\circ\text{C}/\text{W}$

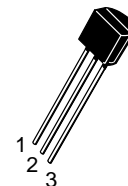
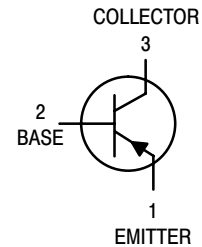

TO-92  
CASE 29  
STYLE 1

### MARKING DIAGRAM

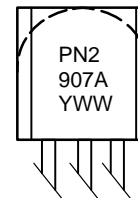

PN2907A = Device Code  
Y = Year  
WW = Work Week

### ORDERING INFORMATION

Device	Package	Shipping
PN2907A	TO-92	5000 Units/Box
PN2907ARLRA	TO-92	2000/Tape & Reel

Preferred devices are recommended choices for future use and best overall value.

# PN2907A

## ELECTRICAL CHARACTERISTICS (T<sub>A</sub> = 25°C unless otherwise noted)

Characteristic	Symbol	Min	Max	Unit
----------------	--------	-----	-----	------

### OFF CHARACTERISTICS

Collector–Emitter Breakdown Voltage (Note 1.) (I <sub>C</sub> = –10 mA <sub>dc</sub> , I <sub>B</sub> = 0)	V <sub>(BR)CEO</sub>	–60	–	V <sub>dc</sub>
Collector–Base Breakdown Voltage (I <sub>C</sub> = –10 μA <sub>dc</sub> , I <sub>E</sub> = 0)	V <sub>(BR)CBO</sub>	–60	–	V <sub>dc</sub>
Emitter–Base Breakdown Voltage (I <sub>E</sub> = –10 μA <sub>dc</sub> , I <sub>C</sub> = 0)	V <sub>(BR)EBO</sub>	–5.0	–	V <sub>dc</sub>
Collector Cutoff Current (V <sub>CE</sub> = –30 V <sub>dc</sub> , V <sub>EB(off)</sub> = –0.5 V <sub>dc</sub> )	I <sub>CEX</sub>	–	–50	nA <sub>dc</sub>
Collector Cutoff Current (V <sub>CB</sub> = –50 V <sub>dc</sub> , I <sub>E</sub> = 0) (V <sub>CB</sub> = –50 V <sub>dc</sub> , I <sub>E</sub> = 0, T <sub>A</sub> = 150°C)	I <sub>CBO</sub>	–	–0.01 –10	μA <sub>dc</sub>
Base Current (V <sub>CE</sub> = –30 V <sub>dc</sub> , V <sub>EB(off)</sub> = –0.5 V <sub>dc</sub> )	I <sub>B</sub>	–	–50	nA <sub>dc</sub>

### ON CHARACTERISTICS

DC Current Gain (I <sub>C</sub> = –0.1 mA <sub>dc</sub> , V <sub>CE</sub> = –10 V <sub>dc</sub> ) (I <sub>C</sub> = –1.0 mA <sub>dc</sub> , V <sub>CE</sub> = –10 V <sub>dc</sub> ) (I <sub>C</sub> = –10 mA <sub>dc</sub> , V <sub>CE</sub> = –10 V <sub>dc</sub> ) (I <sub>C</sub> = –150 mA <sub>dc</sub> , V <sub>CE</sub> = –10 V <sub>dc</sub> ) (Note 1.) (I <sub>C</sub> = –500 mA <sub>dc</sub> , V <sub>CE</sub> = –10 V <sub>dc</sub> ) (Note 1.)	h <sub>FE</sub>	75 100 100 100 50	– – – 300 –	–
Collector–Emitter Saturation Voltage (Note 1.) (I <sub>C</sub> = –150 mA <sub>dc</sub> , I <sub>B</sub> = –15 mA <sub>dc</sub> ) (I <sub>C</sub> = –500 mA <sub>dc</sub> , I <sub>B</sub> = –50 mA <sub>dc</sub> )	V <sub>CE(sat)</sub>	– –	–0.4 –1.6	V <sub>dc</sub>
Base–Emitter Saturation Voltage (Note 1.) (I <sub>C</sub> = –150 mA <sub>dc</sub> , I <sub>B</sub> = –15 mA <sub>dc</sub> ) (I <sub>C</sub> = –500 mA <sub>dc</sub> , I <sub>B</sub> = –50 mA <sub>dc</sub> )	V <sub>BE(sat)</sub>	– –	–1.3 –2.6	V <sub>dc</sub>

### SMALL–SIGNAL CHARACTERISTICS

Current–Gain – Bandwidth Product (Notes 1. and 2.), (I <sub>C</sub> = –50 mA <sub>dc</sub> , V <sub>CE</sub> = –20 V <sub>dc</sub> , f = 100 MHz)	f <sub>T</sub>	200	–	MHz
Output Capacitance (V <sub>CB</sub> = –10 V <sub>dc</sub> , I <sub>E</sub> = 0, f = 1.0 MHz)	C <sub>obo</sub>	–	8.0	pF
Input Capacitance (V <sub>EB</sub> = –2.0 V <sub>dc</sub> , I <sub>C</sub> = 0, f = 1.0 MHz)	C <sub>ibo</sub>	–	30	pF

### SWITCHING CHARACTERISTICS

Turn–On Time	(V <sub>CC</sub> = –30 V <sub>dc</sub> , I <sub>C</sub> = –150 mA <sub>dc</sub> , I <sub>B1</sub> = –15 mA <sub>dc</sub> ) (Figures 1 and 5)	t <sub>on</sub>	–	45	ns
Delay Time		t <sub>d</sub>	–	10	ns
Rise Time		t <sub>r</sub>	–	40	ns
Turn–Off Time	(V <sub>CC</sub> = –6.0 V <sub>dc</sub> , I <sub>C</sub> = –150 mA <sub>dc</sub> , I <sub>B1</sub> = I <sub>B2</sub> = 15 mA <sub>dc</sub> ) (Figure 2)	t <sub>off</sub>	–	100	ns
Storage Time		t <sub>s</sub>	–	80	ns
Fall Time		t <sub>f</sub>	–	30	ns

1. Pulse Test: Pulse Width ≤ 300 μs, Duty Cycle ≤ 2%.
2. f<sub>T</sub> is defined as the frequency at which |h<sub>fe</sub>| extrapolates to unity.

# PN2907A

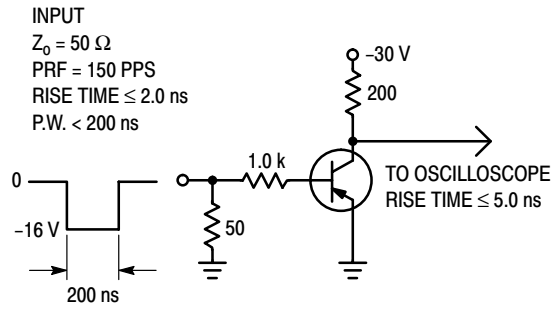

Figure 1. Delay and Rise Time Test Circuit

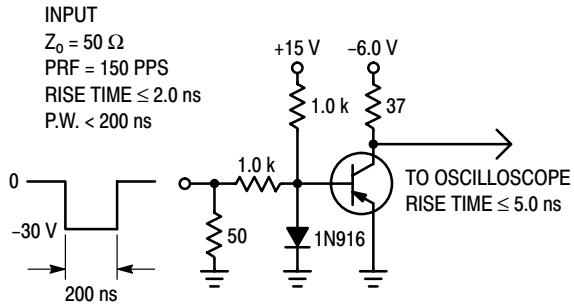

Figure 2. Storage and Fall Time Test Circuit

# PN2907A

## TYPICAL CHARACTERISTICS

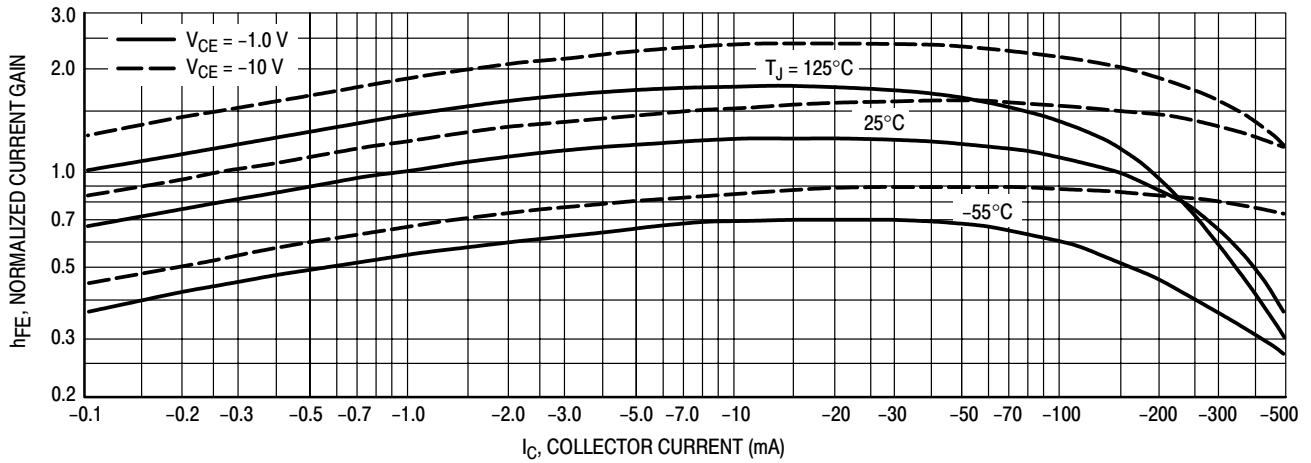

Figure 3. DC Current Gain

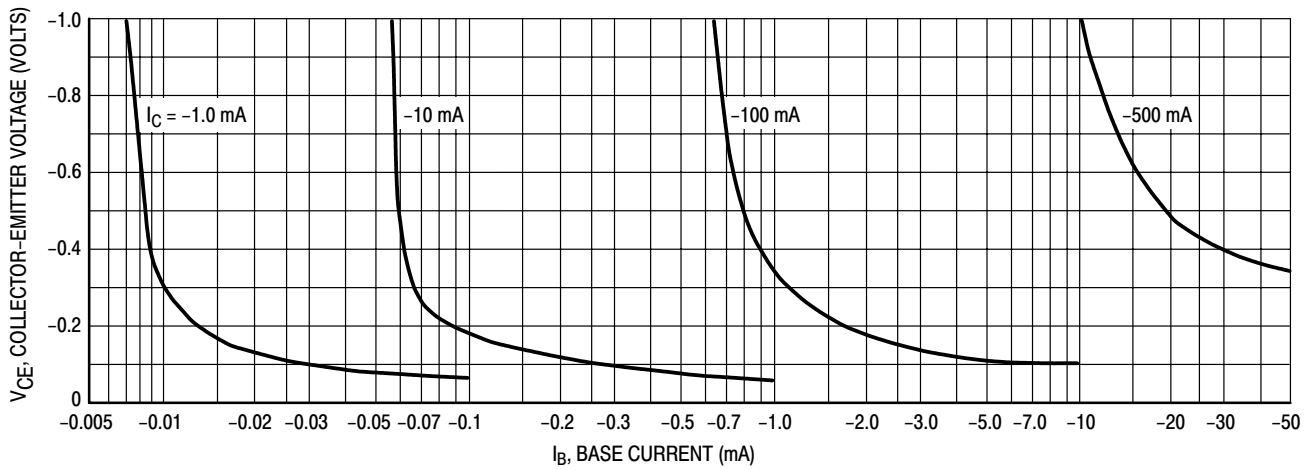

Figure 4. Collector Saturation Region

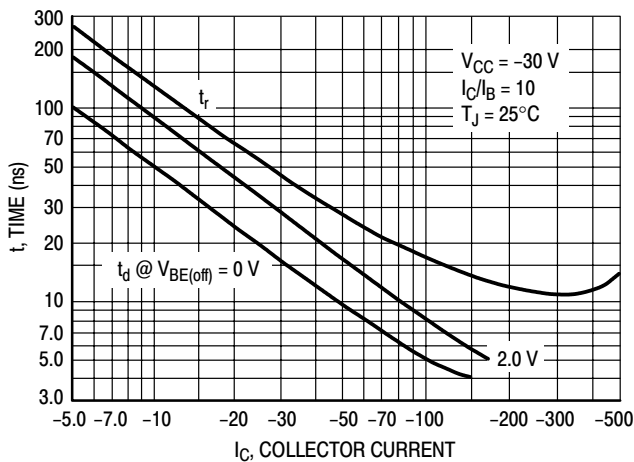

Figure 5. Turn-On Time

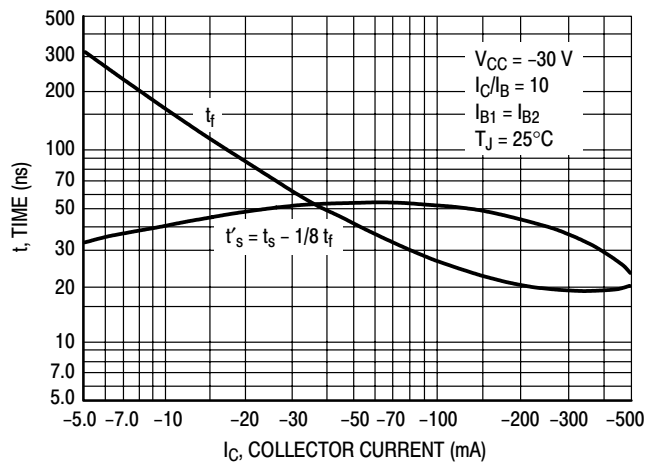

Figure 6. Turn-Off Time

# PN2907A

## TYPICAL SMALL-SIGNAL CHARACTERISTICS

### NOISE FIGURE

$V_{CE} = 10 \text{ Vdc}$ ,  $T_A = 25^\circ\text{C}$

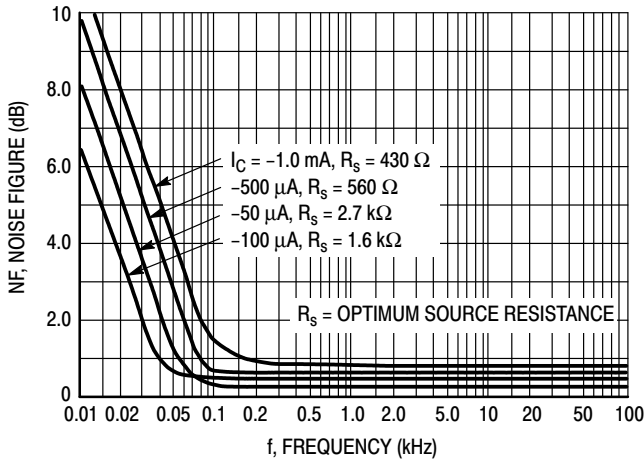

Figure 7. Frequency Effects

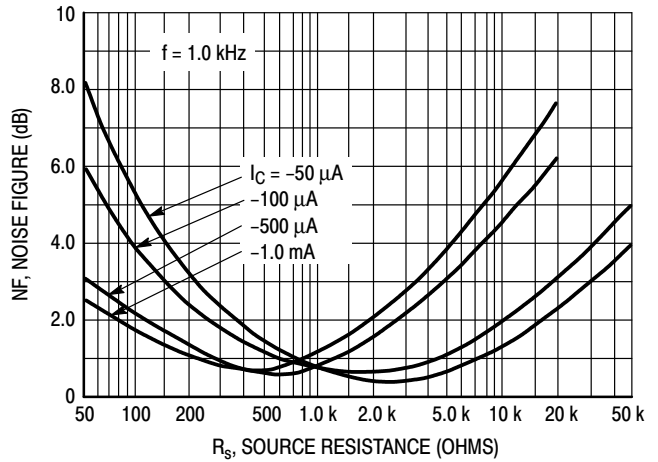

Figure 8. Source Resistance Effects

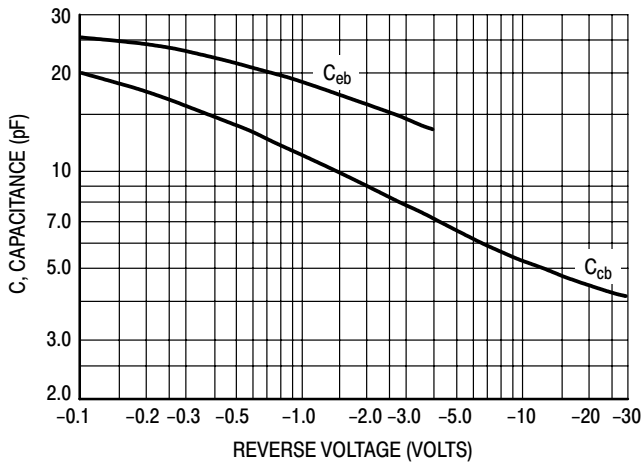

Figure 9. Capacitances

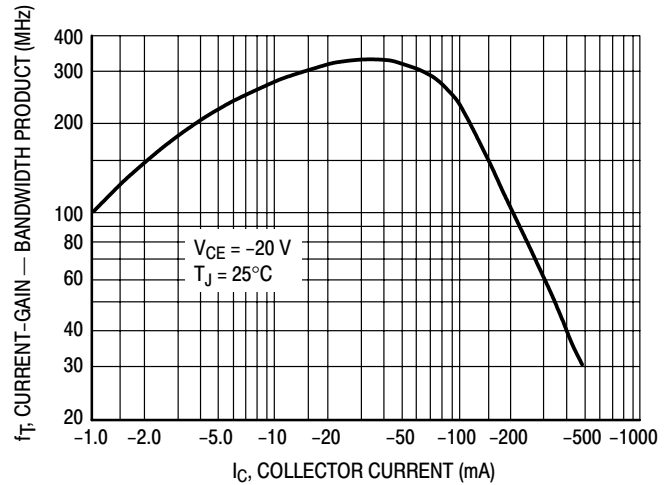

Figure 10. Current-Gain — Bandwidth Product

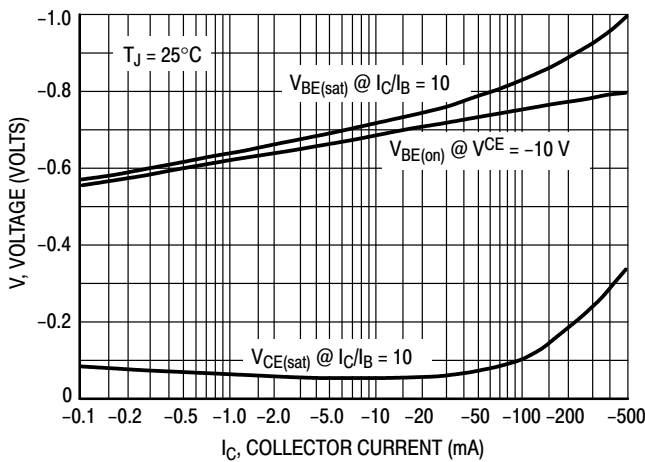

Figure 11. "On" Voltage

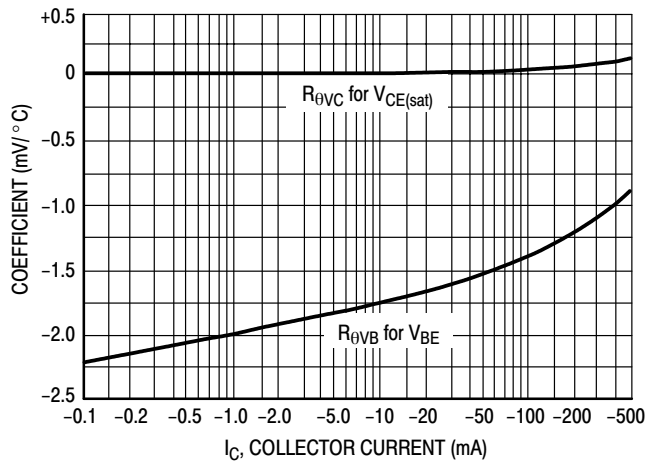
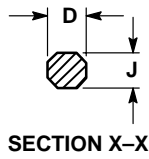
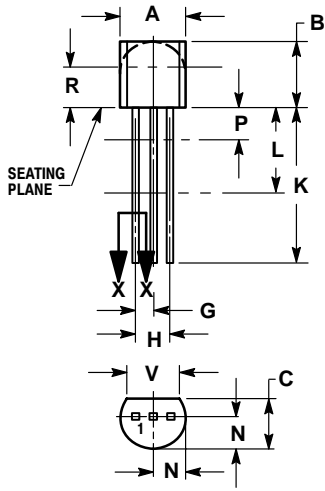

Figure 12. Temperature Coefficients

# PN2907A

## PACKAGE DIMENSIONS

TO-92  
TO-226AA  
CASE 29-11  
ISSUE AL



NOTES:

1. DIMENSIONING AND TOLERANCING PER ANSI Y14.5M, 1982.
2. CONTROLLING DIMENSION: INCH.
3. CONTOUR OF PACKAGE BEYOND DIMENSION R IS UNCONTROLLED.
4. LEAD DIMENSION IS UNCONTROLLED IN P AND BEYOND DIMENSION K MINIMUM.

DIM	INCHES		MILLIMETERS	
	MIN	MAX	MIN	MAX
A	0.175	0.205	4.45	5.20
B	0.170	0.210	4.32	5.33
C	0.125	0.165	3.18	4.19
D	0.016	0.021	0.407	0.533
G	0.045	0.055	1.15	1.39
H	0.095	0.105	2.42	2.66
J	0.015	0.020	0.39	0.50
K	0.500	---	12.70	---
L	0.250	---	6.35	---
N	0.080	0.105	2.04	2.66
P	---	0.100	---	2.54
R	0.115	---	2.93	---
V	0.135	---	3.43	---

STYLE 1:

- PIN 1. EMITTER
2. BASE
3. COLLECTOR

## Notes



**ON Semiconductor** and  are trademarks of Semiconductor Components Industries, LLC (SCILLC). SCILLC reserves the right to make changes without further notice to any products herein. SCILLC makes no warranty, representation or guarantee regarding the suitability of its products for any particular purpose, nor does SCILLC assume any liability arising out of the application or use of any product or circuit, and specifically disclaims any and all liability, including without limitation special, consequential or incidental damages. "Typical" parameters which may be provided in SCILLC data sheets and/or specifications can and do vary in different applications and actual performance may vary over time. All operating parameters, including "Typicals" must be validated for each customer application by customer's technical experts. SCILLC does not convey any license under its patent rights nor the rights of others. SCILLC products are not designed, intended, or authorized for use as components in systems intended for surgical implant into the body, or other applications intended to support or sustain life, or for any other application in which the failure of the SCILLC product could create a situation where personal injury or death may occur. Should Buyer purchase or use SCILLC products for any such unintended or unauthorized application, Buyer shall indemnify and hold SCILLC and its officers, employees, subsidiaries, affiliates, and distributors harmless against all claims, costs, damages, and expenses, and reasonable attorney fees arising out of, directly or indirectly, any claim of personal injury or death associated with such unintended or unauthorized use, even if such claim alleges that SCILLC was negligent regarding the design or manufacture of the part. SCILLC is an Equal Opportunity/Affirmative Action Employer.

## PUBLICATION ORDERING INFORMATION

### Literature Fulfillment:

Literature Distribution Center for ON Semiconductor  
P.O. Box 5163, Denver, Colorado 80217 USA  
**Phone:** 303-675-2175 or 800-344-3860 Toll Free USA/Canada  
**Fax:** 303-675-2176 or 800-344-3867 Toll Free USA/Canada  
**Email:** ONlit@hibbertco.com

**N. American Technical Support:** 800-282-9855 Toll Free USA/Canada

**JAPAN:** ON Semiconductor, Japan Customer Focus Center  
4-32-1 Nishi-Gotanda, Shinagawa-ku, Tokyo, Japan 141-0031  
**Phone:** 81-3-5740-2700  
**Email:** r14525@onsemi.com

**ON Semiconductor Website:** <http://onsemi.com>

For additional information, please contact your local Sales Representative.