

阅读申明

- 1.本站收集的数据手册和产品资料都来自互联网，版权归原作者所有。如读者和版权方有任何异议请及时告之，我们将妥善解决。
- 2.本站提供的中文数据手册是英文数据手册的中文翻译，其目的是协助用户阅读，该译文无法自动跟随原稿更新，同时也可能存在翻译上的不当。建议读者以英文原稿为参考以便获得更精准的信息。
- 3.本站提供的产品资料，来自厂商的技术支持或者使用者的心得体会等，其内容可能存在描述上的差异，建议读者做出适当判断。
- 4.如需与我们联系，请发邮件到marketing@iczoom.com，主题请标有“数据手册”字样。

Read Statement

1. The datasheets and other product information on the site are all from network reference or other public materials, and the copyright belongs to the original author and original published source. If readers and copyright owners have any objections, please contact us and we will deal with it in a timely manner.
2. The Chinese datasheets provided on the website is a Chinese translation of the English datasheets. Its purpose is for reader's learning exchange only and do not involve commercial purposes. The translation cannot be automatically updated with the original manuscript, and there may also be improper translations. Readers are advised to use the English manuscript as a reference for more accurate information.
3. All product information provided on the website refer to solutions from manufacturers' technical support or users the contents may have differences in description, and readers are advised to take the original article as the standard.
4. If you have any questions, please contact us at marketing@iczoom.com and mark the subject with "Datasheets" .

MPS2222, MPS2222A

MPS2222A is a Preferred Device

General Purpose Transistors

NPN Silicon

Features

- Pb-Free Packages are Available*

MAXIMUM RATINGS

Rating	Symbol	Value	Unit
Collector – Emitter Voltage MPS2222 MPS2222A	V_{CEO}	30 40	Vdc
Collector – Base Voltage MPS2222 MPS2222A	V_{CBO}	60 75	Vdc
Emitter – Base Voltage MPS2222 MPS2222A	V_{EBO}	5.0 6.0	Vdc
Collector Current – Continuous	I_C	600	mAdc
Total Device Dissipation @ $T_A = 25^\circ\text{C}$ Derate above 25°C	P_D	625 5.0	mW mW/ $^\circ\text{C}$
Total Device Dissipation @ $T_C = 25^\circ\text{C}$ Derate above 25°C	P_D	1.5 12	W mW/ $^\circ\text{C}$
Operating and Storage Junction Temperature Range	T_J, T_{stg}	-55 to +150	$^\circ\text{C}$

THERMAL CHARACTERISTICS

Characteristic	Symbol	Max	Unit
Thermal Resistance, Junction-to-Ambient	$R_{\theta JA}$	200	$^\circ\text{C}/\text{W}$
Thermal Resistance, Junction-to-Case	$R_{\theta JC}$	83.3	$^\circ\text{C}/\text{W}$

Maximum ratings are those values beyond which device damage can occur. Maximum ratings applied to the device are individual stress limit values (not normal operating conditions) and are not valid simultaneously. If these limits are exceeded, device functional operation is not implied, damage may occur and reliability may be affected.

*For additional information on our Pb-Free strategy and soldering details, please download the ON Semiconductor Soldering and Mounting Techniques Reference Manual, SOLDERRM/D.



ON Semiconductor®

<http://onsemi.com>

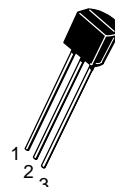
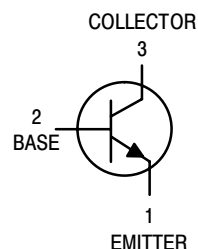

TO-92
CASE 29-11
STYLE 1

MARKING DIAGRAMS

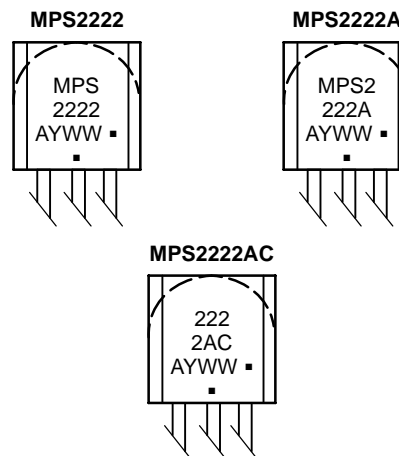

A = Assembly Location
Y = Year
WW = Work Week
▪ = Pb-Free Package
(Note: Microdot may be in either location)

ORDERING INFORMATION

See detailed ordering and shipping information in the package dimensions section on page 6 of this data sheet.

Preferred devices are recommended choices for future use and best overall value.

MPS2222, MPS2222A

ELECTRICAL CHARACTERISTICS (T_A = 25°C unless otherwise noted)

Characteristic		Symbol	Min	Max	Unit
OFF CHARACTERISTICS					
Collector–Emitter Breakdown Voltage (I _C = 10 mA _{dc} , I _B = 0)	MPS2222 MPS2222A	V _{(BR)CEO}	30 40	– –	V _{dc}
Collector–Base Breakdown Voltage (I _C = 10 μA _{dc} , I _E = 0)	MPS2222 MPS2222A	V _{(BR)CBO}	60 75	– –	V _{dc}
Emitter–Base Breakdown Voltage (I _E = 10 μA _{dc} , I _C = 0)	MPS2222 MPS2222A	V _{(BR)EBO}	5.0 6.0	– –	V _{dc}
Collector Cutoff Current (V _{CE} = 60 V _{dc} , V _{EB(off)} = 3.0 V _{dc})	MPS2222A	I _{CEX}	–	10	nA _{dc}
Collector Cutoff Current (V _{CB} = 50 V _{dc} , I _E = 0) (V _{CB} = 60 V _{dc} , I _E = 0) (V _{CB} = 50 V _{dc} , I _E = 0, T _A = 125°C) (V _{CB} = 50 V _{dc} , I _E = 0, T _A = 125°C)	MPS2222 MPS2222A MPS2222 MPS2222A	I _{CBO}	– – – –	0.01 0.01 10 10	μA _{dc}
Emitter Cutoff Current (V _{EB} = 3.0 V _{dc} , I _C = 0)	MPS2222A	I _{EBO}	–	100	nA _{dc}
Base Cutoff Current (V _{CE} = 60 V _{dc} , V _{EB(off)} = 3.0 V _{dc})	MPS2222A	I _{BL}	–	20	nA _{dc}
ON CHARACTERISTICS					
DC Current Gain (I _C = 0.1 mA _{dc} , V _{CE} = 10 V _{dc}) (I _C = 1.0 mA _{dc} , V _{CE} = 10 V _{dc}) (I _C = 10 mA _{dc} , V _{CE} = 10 V _{dc}) (I _C = 10 mA _{dc} , V _{CE} = 10 V _{dc} , T _A = –55°C) (I _C = 150 mA _{dc} , V _{CE} = 10 V _{dc}) (Note 1) (I _C = 150 mA _{dc} , V _{CE} = 1.0 V _{dc}) (Note 1) (I _C = 500 mA _{dc} , V _{CE} = 10 V _{dc}) (Note 1)	MPS2222A only MPS2222 MPS2222A	h _{FE}	35 50 75 35 100 50 30 40	– – – – 300 – – –	–
Collector–Emitter Saturation Voltage (Note 1) (I _C = 150 mA _{dc} , I _B = 15 mA _{dc}) (I _C = 500 mA _{dc} , I _B = 50 mA _{dc})	MPS2222 MPS2222A MPS2222 MPS2222A	V _{CE(sat)}	– – – –	0.4 0.3 1.6 1.0	V _{dc}
Base–Emitter Saturation Voltage (Note 1) (I _C = 150 mA _{dc} , I _B = 15 mA _{dc}) (I _C = 500 mA _{dc} , I _B = 50 mA _{dc})	MPS2222 MPS2222A MPS2222 MPS2222A	V _{BE(sat)}	– 0.6 – –	1.3 1.2 2.6 2.0	V _{dc}
SMALL–SIGNAL CHARACTERISTICS					
Current–Gain – Bandwidth Product (Note 2) (I _C = 20 mA _{dc} , V _{CE} = 20 V _{dc} , f = 100 MHz)	MPS2222 MPS2222A	f _T	250 300	– –	MHz
Output Capacitance (V _{CB} = 10 V _{dc} , I _E = 0, f = 1.0 MHz)		C _{obo}	–	8.0	pF
Input Capacitance (V _{EB} = 0.5 V _{dc} , I _C = 0, f = 1.0 MHz)	MPS2222 MPS2222A	C _{ibo}	– –	30 25	pF
Input Impedance (I _C = 1.0 mA _{dc} , V _{CE} = 10 V _{dc} , f = 1.0 kHz) (I _C = 10 mA _{dc} , V _{CE} = 10 V _{dc} , f = 1.0 kHz)	MPS2222A MPS2222A	h _{ie}	2.0 0.25	8.0 1.25	kΩ
Voltage Feedback Ratio (I _C = 1.0 mA _{dc} , V _{CE} = 10 V _{dc} , f = 1.0 kHz) (I _C = 10 mA _{dc} , V _{CE} = 10 V _{dc} , f = 1.0 kHz)	MPS2222A MPS2222A	h _{re}	– –	8.0 4.0	X 10 ^{–4}
Small–Signal Current Gain (I _C = 1.0 mA _{dc} , V _{CE} = 10 V _{dc} , f = 1.0 kHz) (I _C = 10 mA _{dc} , V _{CE} = 10 V _{dc} , f = 1.0 kHz)	MPS2222A MPS2222A	h _{fe}	50 75	300 375	–
Output Admittance (I _C = 1.0 mA _{dc} , V _{CE} = 10 V _{dc} , f = 1.0 kHz) (I _C = 10 mA _{dc} , V _{CE} = 10 V _{dc} , f = 1.0 kHz)	MPS2222A MPS2222A	h _{oe}	5.0 25	35 200	μmhos
Collector Base Time Constant (I _E = 20 mA _{dc} , V _{CB} = 20 V _{dc} , f = 31.8 MHz)	MPS2222A	rb'C _c	–	150	ps
Noise Figure (I _C = 100 μA _{dc} , V _{CE} = 10 V _{dc} , R _S = 1.0 kΩ, f = 1.0 kHz)	MPS2222A	NF	–	4.0	dB

1. Pulse Test: Pulse Width ≤ 300 μs, Duty Cycle ≤ 2%.
2. f_T is defined as the frequency at which |h_{fe}| extrapolates to unity.

MPS2222, MPS2222A

ELECTRICAL CHARACTERISTICS ($T_A = 25^\circ\text{C}$ unless otherwise noted) (Continued)

Characteristic	Symbol	Min	Max	Unit
SWITCHING CHARACTERISTICS MPS2222A only				
Delay Time	t_d	–	10	ns
Rise Time	t_r	–	25	ns
Storage Time	t_s	–	225	ns
Fall Time	t_f	–	60	ns

SWITCHING TIME EQUIVALENT TEST CIRCUITS

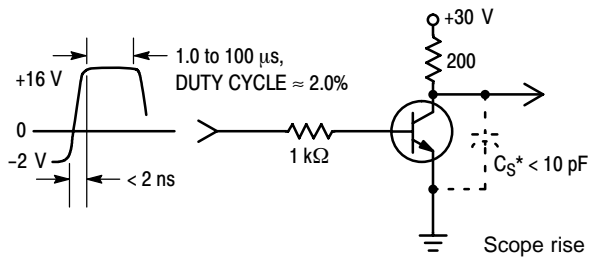

Figure 1. Turn-On Time

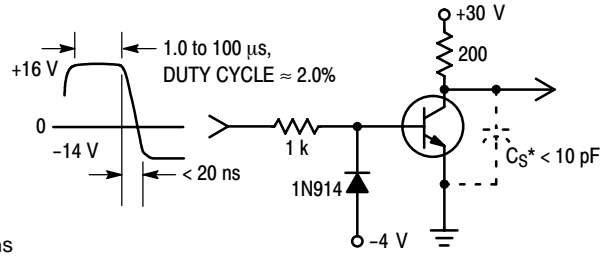

Figure 2. Turn-Off Time

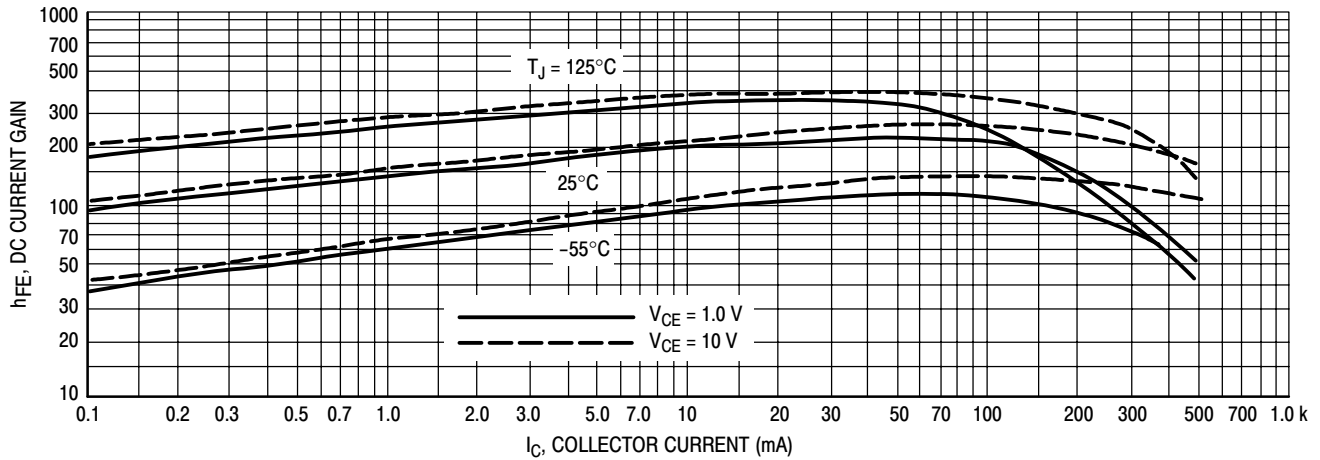

Figure 3. DC Current Gain

MPS2222, MPS2222A

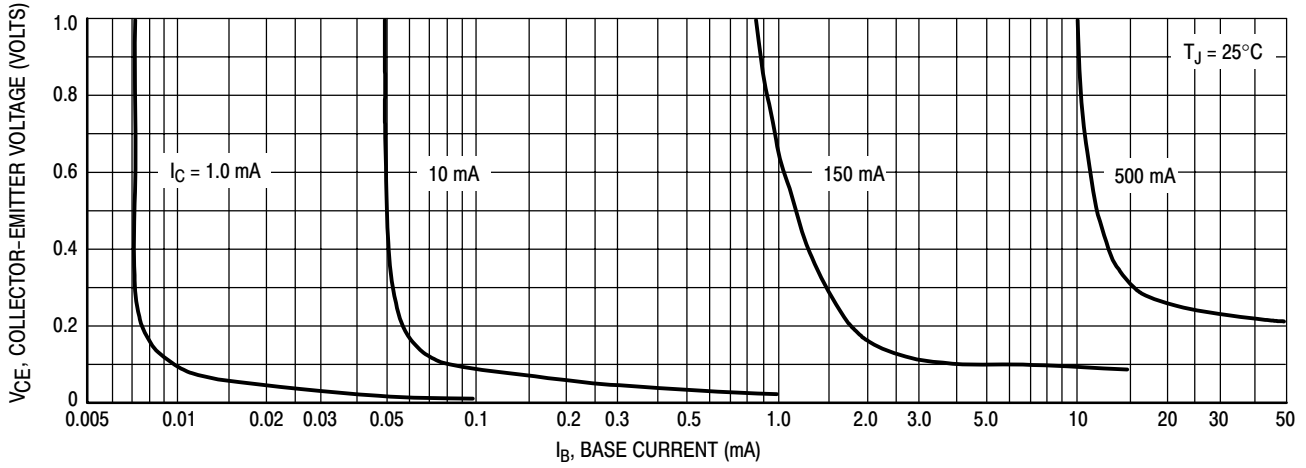

Figure 4. Collector Saturation Region

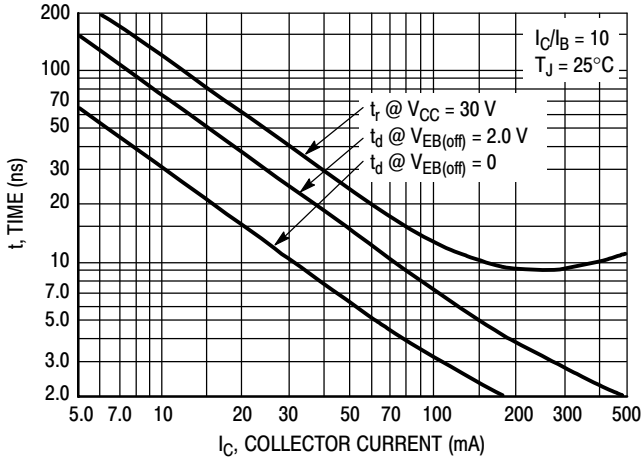

Figure 5. Turn-On Time

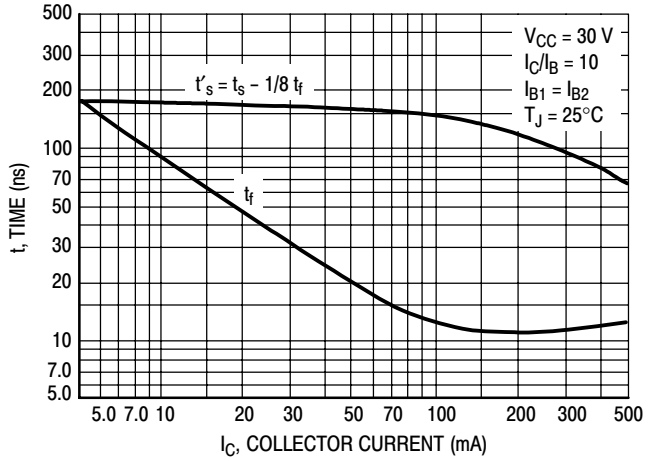

Figure 6. Turn-Off Time

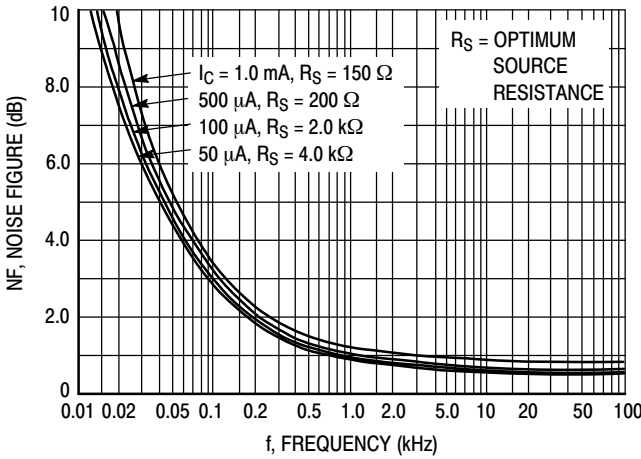

Figure 7. Frequency Effects

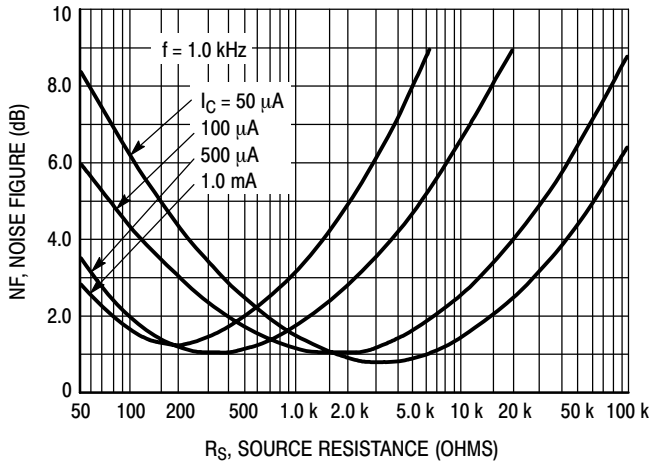

Figure 8. Source Resistance Effects

MPS2222, MPS2222A

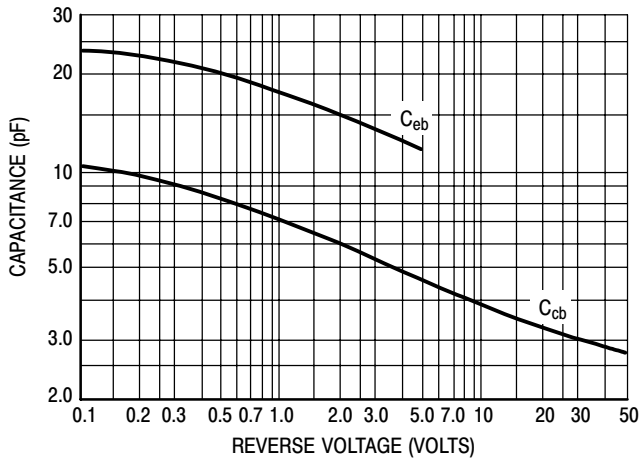

Figure 9. Capacitances

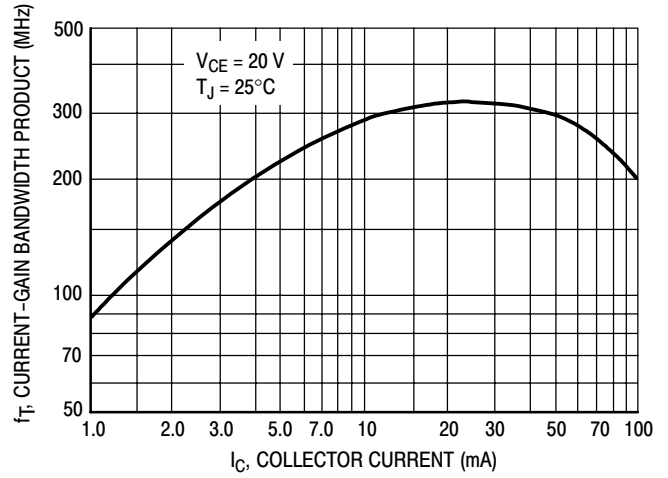

Figure 10. Current-Gain Bandwidth Product

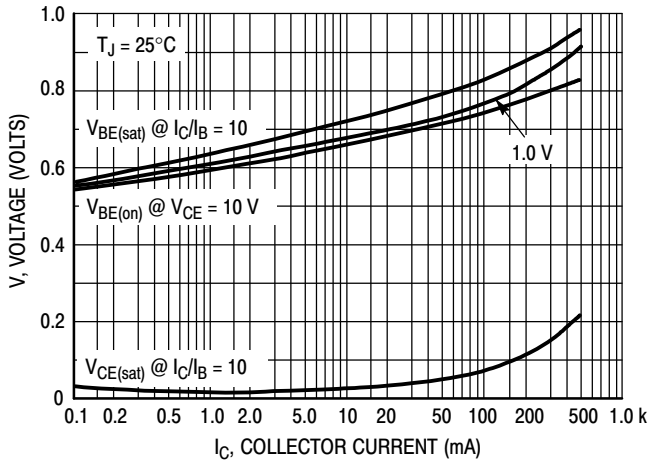

Figure 11. "On" Voltages

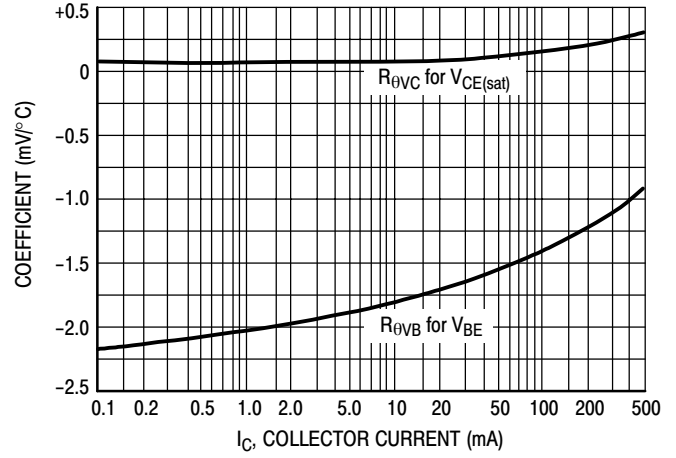

Figure 12. Temperature Coefficients

MPS2222, MPS2222A

ORDERING INFORMATION

Device	Package	Shipping†
MPS2222	TO-92	5000 Units / Bulk
MPS2222G	TO-92 (Pb-Free)	5000 Units / Bulk
MPS2222RLRA	TO-92	2000 / Tape & Reel
MPS2222RLRAG	TO-92 (Pb-Free)	2000 / Tape & Reel
MPS2222RLRM	TO-92	2000 / Tape & Ammo Box
MPS2222RLRMG	TO-92 (Pb-Free)	2000 / Tape & Ammo Box
MPS2222RLRP	TO-92	2000 / Tape & Ammo Box
MPS2222RLRPG	TO-92 (Pb-Free)	2000 / Tape & Ammo Box
MPS2222A	TO-92	5000 Units / Bulk
MPS2222AG	TO-92 (Pb-Free)	5000 Units / Bulk
MPS2222ARL	TO-92	2000 / Tape & Reel
MPS2222ARLG	TO-92 (Pb-Free)	2000 / Tape & Reel
MPS2222ARLRA	TO-92	2000 / Tape & Reel
MPS2222ARLRAG	TO-92 (Pb-Free)	2000 / Tape & Reel
MPS2222ARLRM	TO-92	2000 / Tape & Reel
MPS2222ARLRMG	TO-92 (Pb-Free)	2000 / Tape & Reel
MPS2222ARLRP	TO-92	2000 / Tape & Ammo Box
MPS2222ARLRPG	TO-92 (Pb-Free)	2000 / Tape & Ammo Box
MPS2222AZL1	TO-92	2000 / Tape & Ammo Box
MPS2222AZL1G	TO-92 (Pb-Free)	2000 / Tape & Ammo Box
MPS2222ACLRP	TO-92	2000 / Tape & Ammo Box
MPS2222ACLRPG	TO-92 (Pb-Free)	2000 / Tape & Ammo Box

†For information on tape and reel specifications, including part orientation and tape sizes, please refer to our Tape and Reel Packaging Specifications Brochure, BRD8011/D.

MPS2222, MPS2222A

PACKAGE DIMENSIONS

TO-92 (TO-226)
CASE 29-11
ISSUE AL

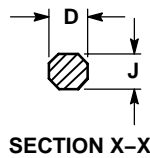
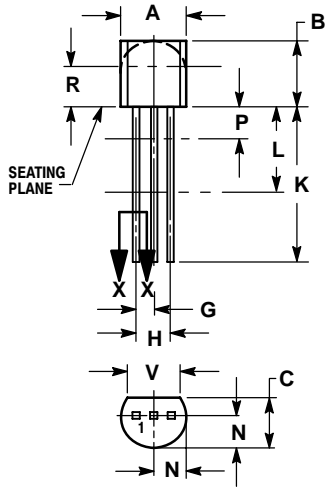

NOTES:

1. DIMENSIONING AND TOLERANCING PER ANSI Y14.5M, 1982.
2. CONTROLLING DIMENSION: INCH.
3. CONTOUR OF PACKAGE BEYOND DIMENSION R IS UNCONTROLLED.
4. LEAD DIMENSION IS UNCONTROLLED IN P AND BEYOND DIMENSION K MINIMUM.

DIM	INCHES		MILLIMETERS	
	MIN	MAX	MIN	MAX
A	0.175	0.205	4.45	5.20
B	0.170	0.210	4.32	5.33
C	0.125	0.165	3.18	4.19
D	0.016	0.021	0.407	0.533
G	0.045	0.055	1.15	1.39
H	0.095	0.105	2.42	2.66
J	0.015	0.020	0.39	0.50
K	0.500	---	12.70	---
L	0.250	---	6.35	---
N	0.080	0.105	2.04	2.66
P	---	0.100	---	2.54
R	0.115	---	2.93	---
V	0.135	---	3.43	---

STYLE 1:

1. PIN 1. EMITTER
2. BASE
3. COLLECTOR

ON Semiconductor and are registered trademarks of Semiconductor Components Industries, LLC (SCILLC). SCILLC reserves the right to make changes without further notice to any products herein. SCILLC makes no warranty, representation or guarantee regarding the suitability of its products for any particular purpose, nor does SCILLC assume any liability arising out of the application or use of any product or circuit, and specifically disclaims any and all liability, including without limitation special, consequential or incidental damages. "Typical" parameters which may be provided in SCILLC data sheets and/or specifications can and do vary in different applications and actual performance may vary over time. All operating parameters, including "Typicals" must be validated for each customer application by customer's technical experts. SCILLC does not convey any license under its patent rights nor the rights of others. SCILLC products are not designed, intended, or authorized for use as components in systems intended for surgical implant into the body, or other applications intended to support or sustain life, or for any other application in which the failure of the SCILLC product could create a situation where personal injury or death may occur. Should Buyer purchase or use SCILLC products for any such unintended or unauthorized application, Buyer shall indemnify and hold SCILLC and its officers, employees, subsidiaries, affiliates, and distributors harmless against all claims, costs, damages, and expenses, and reasonable attorney fees arising out of, directly or indirectly, any claim of personal injury or death associated with such unintended or unauthorized use, even if such claim alleges that SCILLC was negligent regarding the design or manufacture of the part. SCILLC is an Equal Opportunity/Affirmative Action Employer. This literature is subject to all applicable copyright laws and is not for resale in any manner.

PUBLICATION ORDERING INFORMATION

LITERATURE FULFILLMENT:

Literature Distribution Center for ON Semiconductor
P.O. Box 61312, Phoenix, Arizona 85082-1312 USA
Phone: 480-829-7710 or 800-344-3860 Toll Free USA/Canada
Fax: 480-829-7709 or 800-344-3867 Toll Free USA/Canada
Email: orderlit@onsemi.com

N. American Technical Support: 800-282-9855 Toll Free
USA/Canada

Japan: ON Semiconductor, Japan Customer Focus Center
2-9-1 Kamimeguro, Meguro-ku, Tokyo, Japan 153-0051
Phone: 81-3-5773-3850

ON Semiconductor Website: <http://onsemi.com>

Order Literature: <http://www.onsemi.com/litorder>

For additional information, please contact your
local Sales Representative.