

阅读申明

- 1.本站收集的数据手册和产品资料都来自互联网，版权归原作者所有。如读者和版权方有任何异议请及时告之，我们将妥善解决。
- 2.本站提供的中文数据手册是英文数据手册的中文翻译，其目的是协助用户阅读，该译文无法自动跟随原稿更新，同时也可能存在翻译上的不当。建议读者以英文原稿为参考以便获得更精准的信息。
- 3.本站提供的产品资料，来自厂商的技术支持或者使用者的心得体会等，其内容可能存在描述上的差异，建议读者做出适当判断。
- 4.如需与我们联系，请发邮件到marketing@iczoom.com，主题请标有“数据手册”字样。

Read Statement

1. The datasheets and other product information on the site are all from network reference or other public materials, and the copyright belongs to the original author and original published source. If readers and copyright owners have any objections, please contact us and we will deal with it in a timely manner.
2. The Chinese datasheets provided on the website is a Chinese translation of the English datasheets. Its purpose is for reader's learning exchange only and do not involve commercial purposes. The translation cannot be automatically updated with the original manuscript, and there may also be improper translations. Readers are advised to use the English manuscript as a reference for more accurate information.
3. All product information provided on the website refer to solutions from manufacturers' technical support or users the contents may have differences in description, and readers are advised to take the original article as the standard.
4. If you have any questions, please contact us at marketing@iczoom.com and mark the subject with "Datasheets" .

PNP Silicon AF Transistor

- For general AF applications
- High collector current
- High current gain
- Low collector-emitter saturation voltage
- Complementary type:
BC817.../W, BC818.../W (NPN)
- Pb-free (RoHS compliant) package¹⁾
- Qualified according AEC Q101

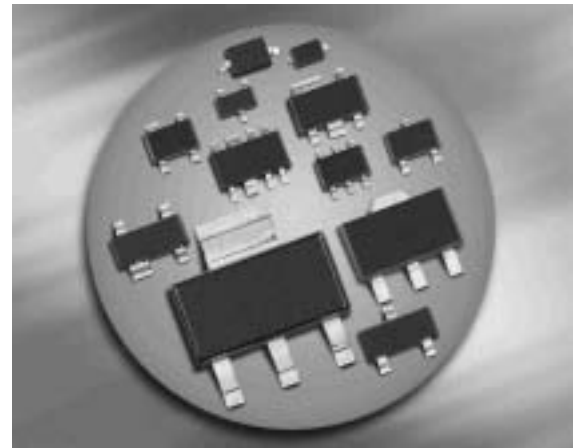

Type	Marking	Pin Configuration						Package
		1 = B	2 = E	3 = C	-	-	-	
BC807-16	5As	1 = B	2 = E	3 = C	-	-	-	SOT23
BC807-16W	5As	1 = B	2 = E	3 = C	-	-	-	SOT323
BC807-25	5Bs	1 = B	2 = E	3 = C	-	-	-	SOT23
BC807-25W	5Bs	1 = B	2 = E	3 = C	-	-	-	SOT323
BC807-40	5Cs	1 = B	2 = E	3 = C	-	-	-	SOT23
BC807-40W	5Cs	1 = B	2 = E	3 = C	-	-	-	SOT323
BC808-25	5Fs	1 = B	2 = E	3 = C	-	-	-	SOT23
BC808-25W	5Fs	1 = B	2 = E	3 = C	-	-	-	SOT323
BC808-40	5Gs	1 = B	2 = E	3 = C	-	-	-	SOT23
BC808-40W	5Gs	1 = B	2 = E	3 = C	-	-	-	SOT323

¹Pb-containing package may be available upon special request

Maximum Ratings

Parameter	Symbol	Value	Unit
Collector-emitter voltage BC807... BC808...	V_{CEO}	45 25	V
Collector-base voltage BC807... BC808...	V_{CBO}	50 30	
Emitter-base voltage	V_{EBO}	5	
Collector current	I_C	500	mA
Peak collector current	I_{CM}	1000	
Base current	I_B	100	
Peak base current	I_{BM}	200	
Total power dissipation- $T_S \leq 79\text{ °C}$ BC807, BC808 $T_S \leq 130\text{ °C}$ BC807W, BC808W	P_{tot}	330 250	mW
Junction temperature	T_j	150	°C
Storage temperature	T_{stg}	-65 ... 150	

Thermal Resistance

Parameter	Symbol	Value	Unit
Junction - soldering point ¹⁾ BC807, BC808 BC807W, BC808W	R_{thJS}	≤ 215 ≤ 80	K/W

¹For calculation of R_{thJA} please refer to Application Note Thermal Resistance

Electrical Characteristics at $T_A = 25^\circ\text{C}$, unless otherwise specified

Parameter	Symbol	Values			Unit
		min.	typ.	max.	
DC Characteristics					
Collector-emitter breakdown voltage $I_C = 10\text{ mA}$, $I_B = 0$, BC807... $I_C = 10\text{ mA}$, $I_B = 0$, BC808...	$V_{(BR)CEO}$	45 25	- -	- -	V
Collector-base breakdown voltage $I_C = 10\text{ }\mu\text{A}$, $I_E = 0$, BC807... $I_C = 10\text{ }\mu\text{A}$, $I_E = 0$, BC808...	$V_{(BR)CBO}$	50 30	- -	- -	
Emitter-base breakdown voltage $I_E = 10\text{ }\mu\text{A}$, $I_C = 0$	$V_{(BR)EBO}$	5	-	-	
Collector-base cutoff current $V_{CB} = 25\text{ V}$, $I_E = 0$ $V_{CB} = 25\text{ V}$, $I_E = 0$, $T_A = 150^\circ\text{C}$	I_{CBO}	- -	- -	0.1 50	μA
Emitter-base cutoff current $V_{EB} = 4\text{ V}$, $I_C = 0$	I_{EBO}	-	-	100	nA
DC current gain ¹⁾ $I_C = 100\text{ mA}$, $V_{CE} = 1\text{ V}$, h_{FE} -grp. 16 $I_C = 100\text{ mA}$, $V_{CE} = 1\text{ V}$, h_{FE} -grp. 25 $I_C = 100\text{ mA}$, $V_{CE} = 1\text{ V}$, h_{FE} grp. 40 $I_C = 500\text{ mA}$, $V_{CE} = 1\text{ V}$	h_{FE}	100 160 250 40	160 250 350 -	250 400 630 -	-
Collector-emitter saturation voltage ¹⁾ $I_C = 500\text{ mA}$, $I_B = 50\text{ mA}$	V_{CEsat}	-	-	0.7	V
Base emitter saturation voltage ¹⁾ $I_C = 500\text{ mA}$, $I_B = 50\text{ mA}$	V_{BEsat}	-	-	1.2	

¹⁾Pulse test: $t < 300\mu\text{s}$; $D < 2\%$

Electrical Characteristics at $T_A = 25^\circ\text{C}$, unless otherwise specified

Parameter	Symbol	Values			Unit
		min.	typ.	max.	
AC Characteristics					
Transition frequency $I_C = 50\text{ mA}$, $V_{CE} = 5\text{ V}$, $f = 100\text{ MHz}$	f_T	-	200	-	MHz
Collector-base capacitance $V_{CB} = 10\text{ V}$, $f = 1\text{ MHz}$	C_{cb}	-	8	-	pF
Emitter-base capacitance $V_{EB} = 0.5\text{ V}$, $f = 1\text{ MHz}$	C_{eb}	-	60	-	

DC current gain $h_{FE} = f(I_C)$

$V_{CE} = 1\text{ V}$

h_{FE} -grp. 16

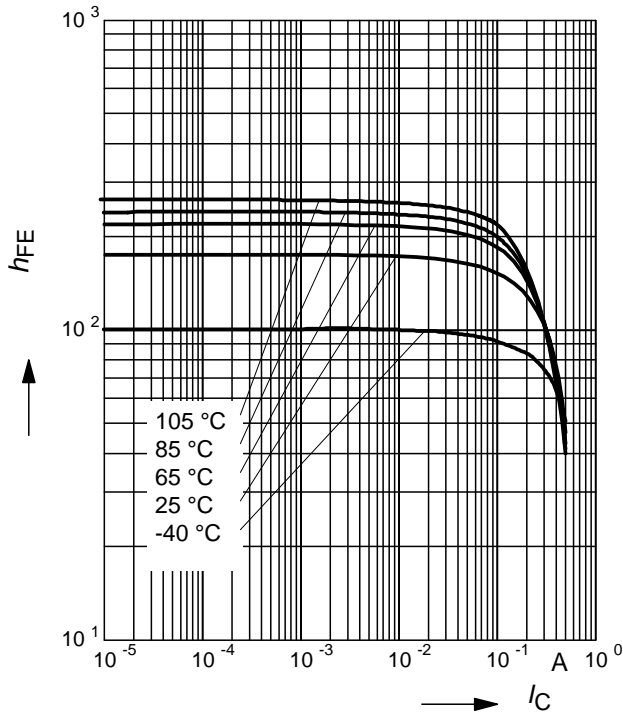

DC current gain $h_{FE} = f(I_C)$

$V_{CE} = 1\text{ V}$

h_{FE} -grp. 25

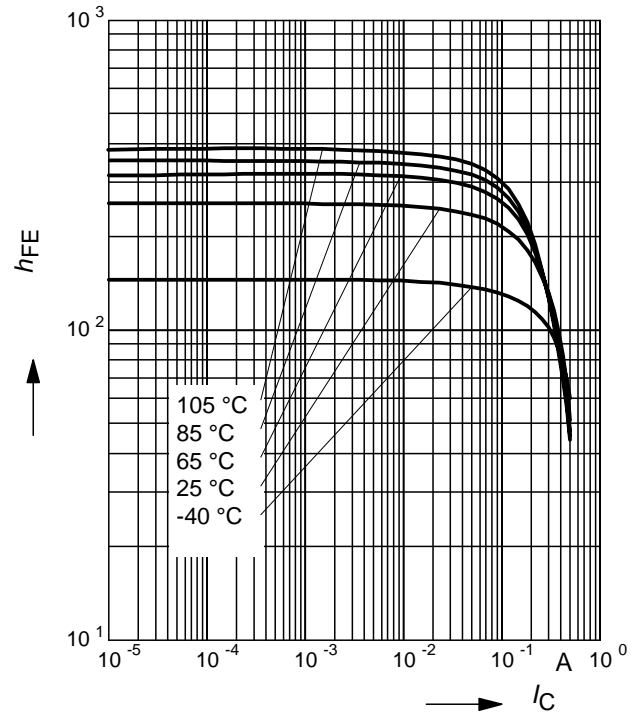

DC current gain $h_{FE} = f(I_C)$

$V_{CE} = 1\text{ V}$

h_{FE} -grp. 40

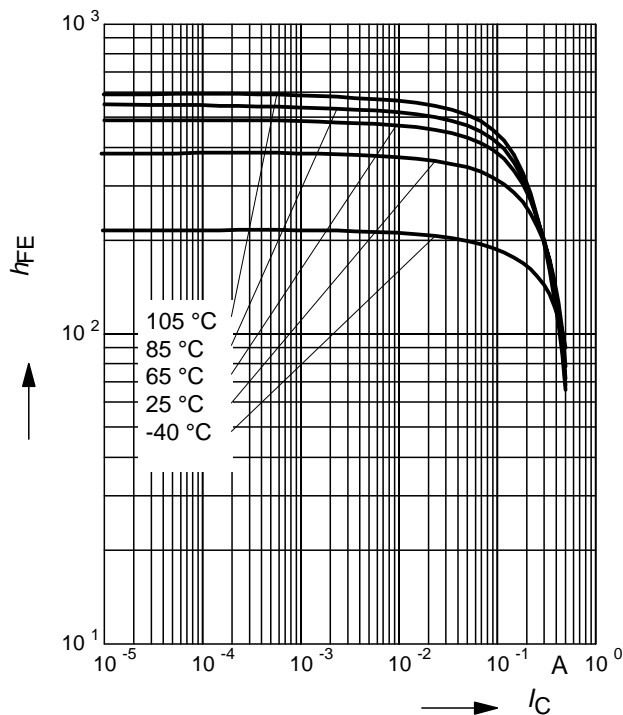

Collector-emitter saturation voltage

$I_C = f(V_{CEsat}), h_{FE} = 10$

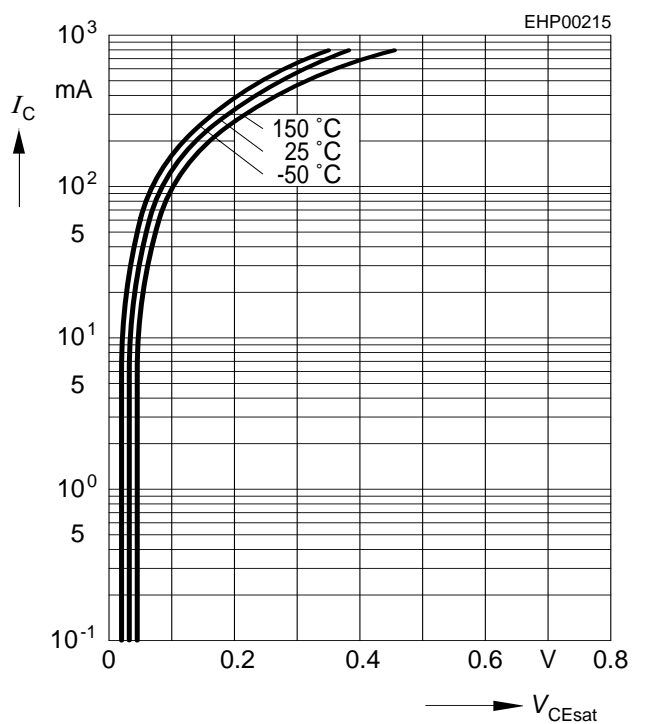

Base-emitter saturation voltage

$I_C = f(V_{BEsat}), h_{FE} = 10$

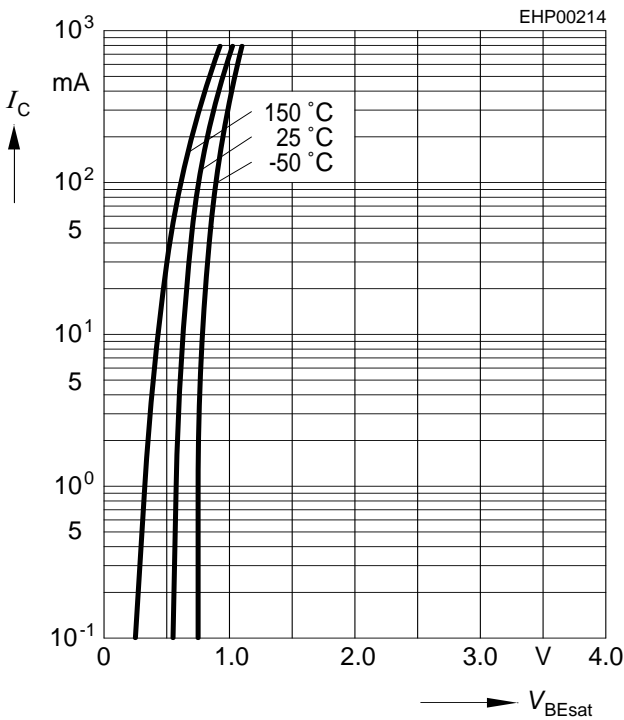

Collector cutoff current $I_{CBO} = f(T_A)$

$V_{CBO} = 25 V$

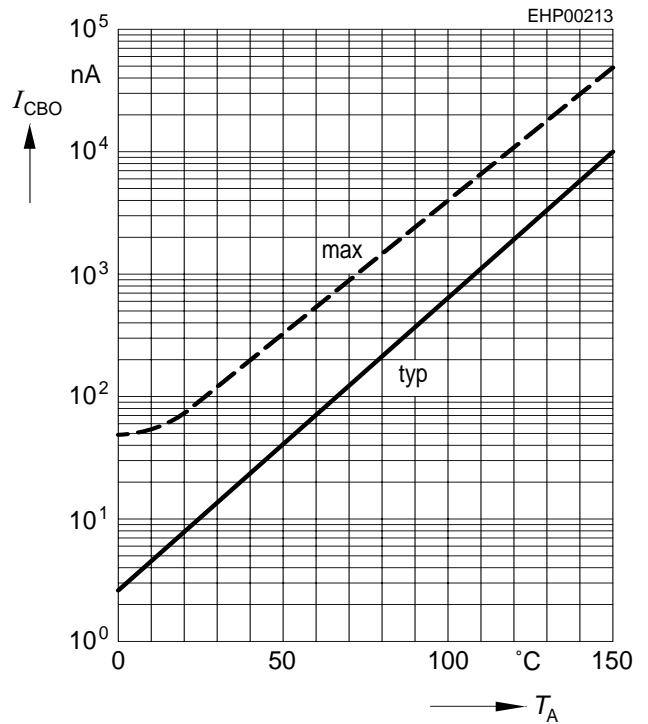

Transition frequency $f_T = f(I_C)$

$V_{CE} = \text{parameter in V}, f = 2 \text{ GHz}$

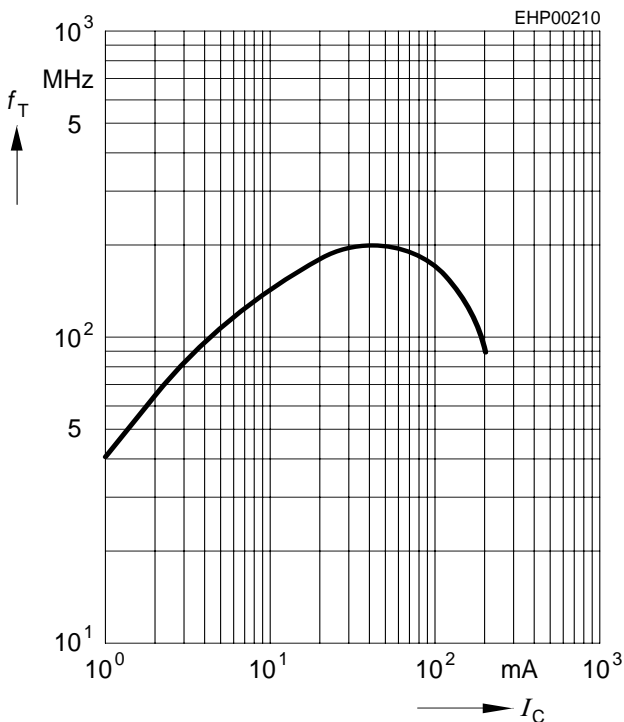

Collector-base capacitance $C_{cb} = f(V_{CB})$

Emitter-base capacitance $C_{eb} = f(V_{EB})$

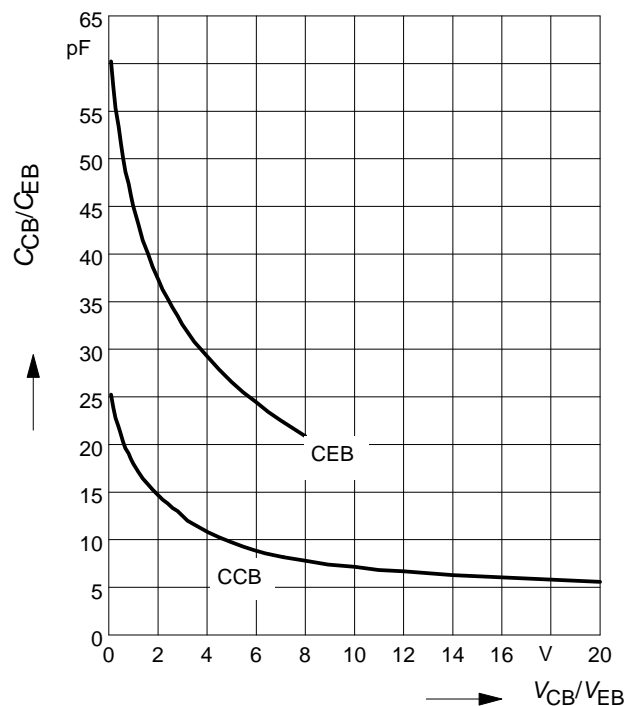

Total power dissipation $P_{tot} = f(T_S)$

BC807, BC808

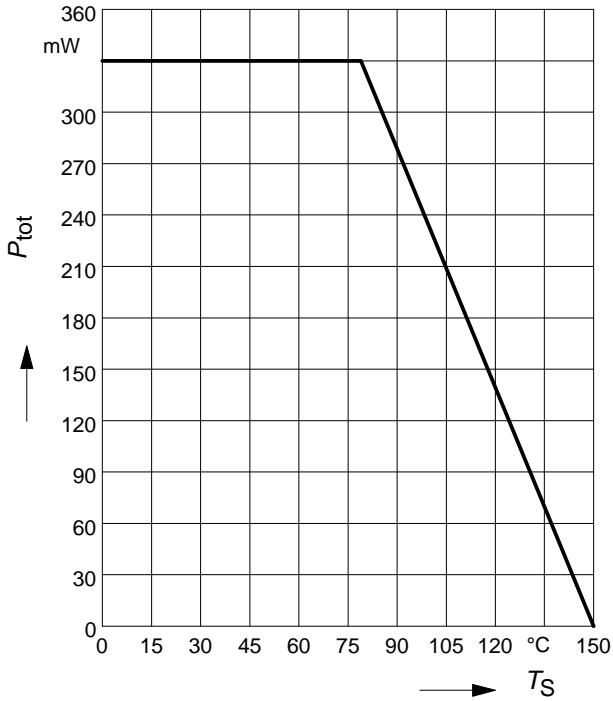

Total power dissipation $P_{tot} = f(T_S)$

BC807W, BC808W

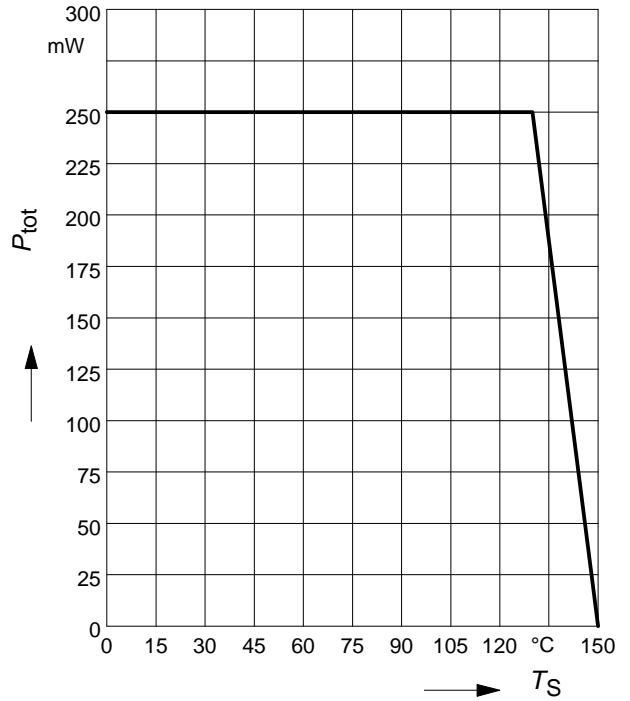

Permissible Pulse Load $R_{thJS} = f(t_p)$

BC807, BC808

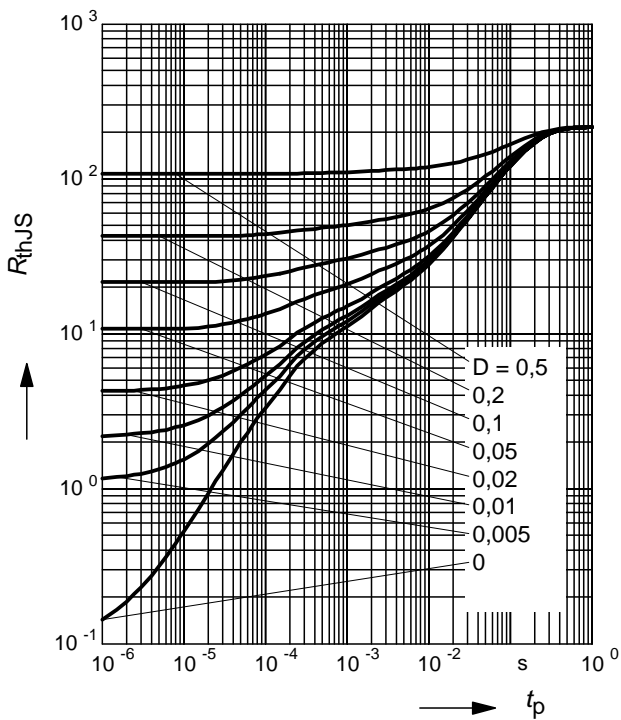

Permissible Pulse Load

$P_{totmax}/P_{totDC} = f(t_p)$

BC807, BC808

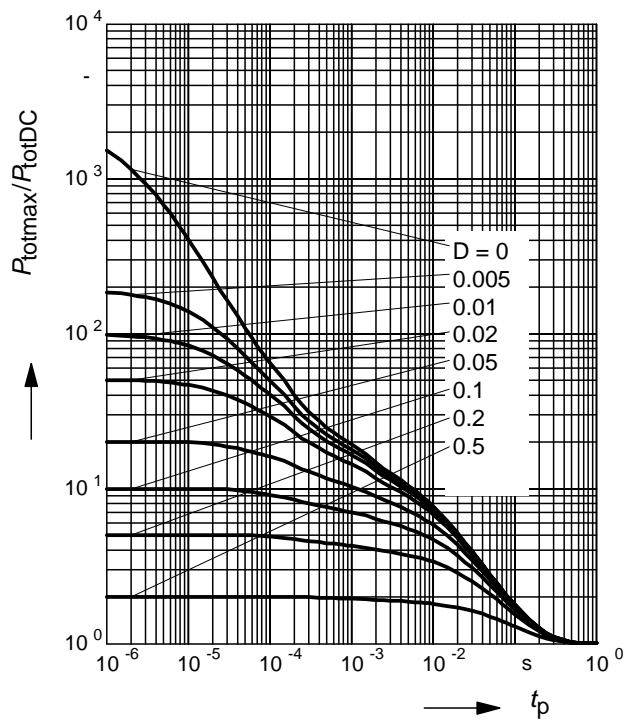

Permissible Puls Load $R_{thJS} = f(t_p)$

BC807W, BC808W

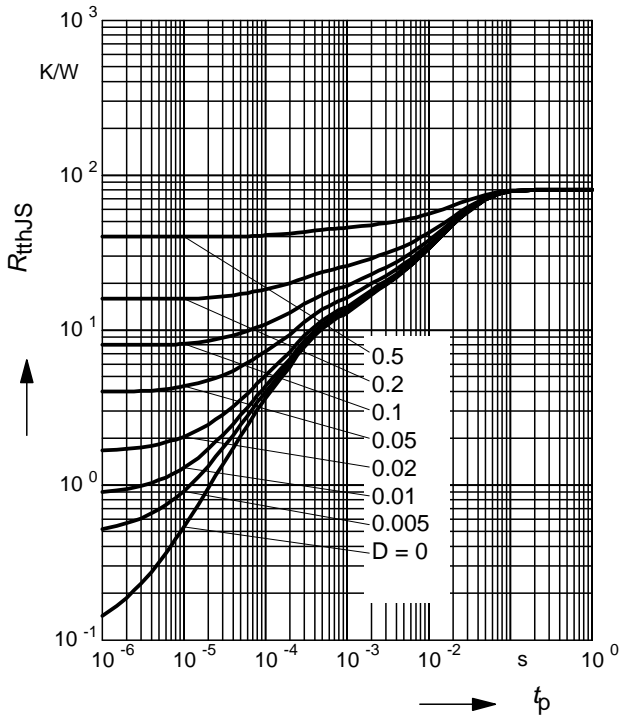

Permissible Pulse Load

$P_{totmax}/P_{totDC} = f(t_p)$

BC807W, BC808W

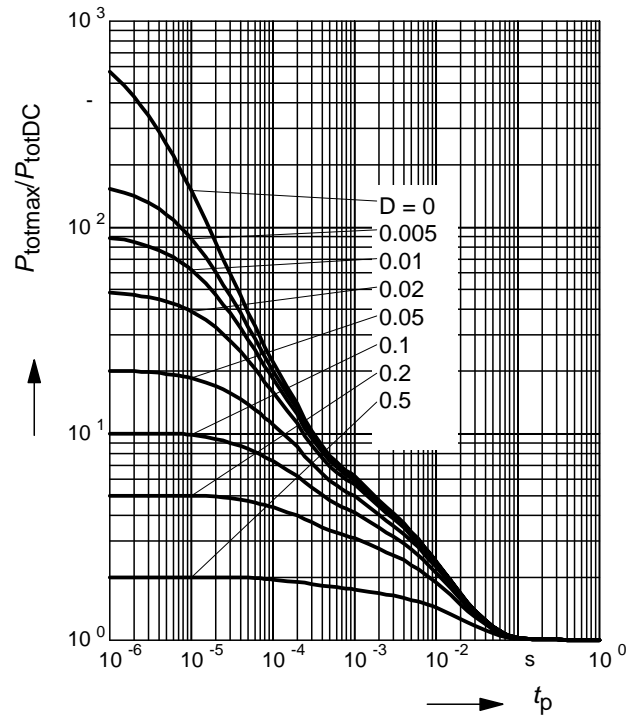

Package Outline



1) Lead width can be 0.6 max. in dambar area

Foot Print

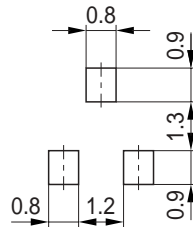

Marking Layout (Example)

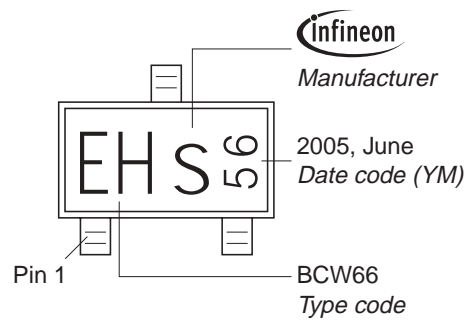

Standard Packing

Reel \varnothing 180 mm = 3.000 Pieces/Reel
 Reel \varnothing 330 mm = 10.000 Pieces/Reel

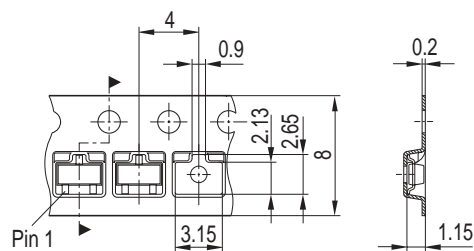

Package Outline

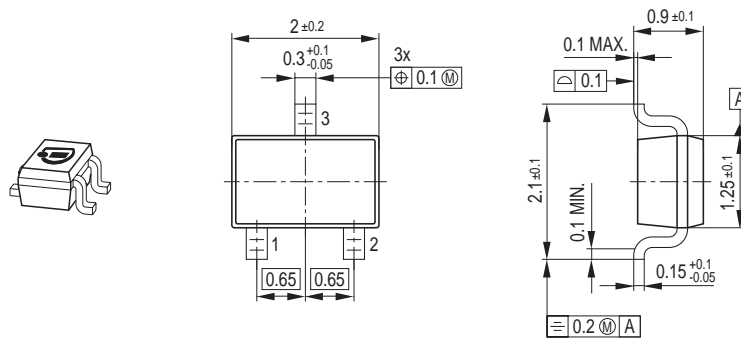

Foot Print

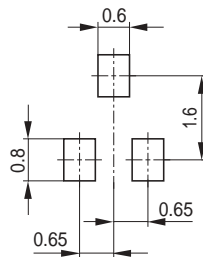

Marking Layout (Example)

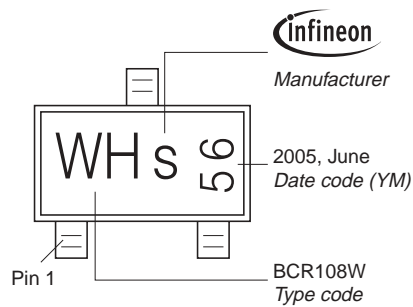

Standard Packing

Reel \varnothing 180 mm = 3.000 Pieces/Reel
 Reel \varnothing 330 mm = 10.000 Pieces/Reel

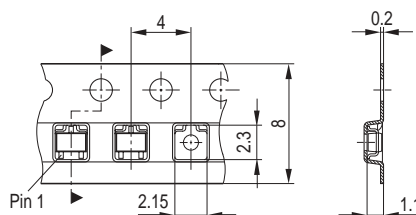

Edition 2006-02-01

Published by

Infineon Technologies AG

81726 München, Germany

© Infineon Technologies AG 2007.

All Rights Reserved.

Attention please!

The information given in this dokument shall in no event be regarded as a guarantee of conditions or characteristics ("Beschaffenheitsgarantie"). With respect to any examples or hints given herein, any typical values stated herein and/or any information regarding the application of the device, Infineon Technologies hereby disclaims any and all warranties and liabilities of any kind, including without limitation warranties of non-infringement of intellectual property rights of any third party.

Information

For further information on technology, delivery terms and conditions and prices please contact your nearest Infineon Technologies Office (www.infineon.com).

Warnings

Due to technical requirements components may contain dangerous substances. For information on the types in question please contact your nearest Infineon Technologies Office.

Infineon Technologies Components may only be used in life-support devices or systems with the express written approval of Infineon Technologies, if a failure of such components can reasonably be expected to cause the failure of that life-support device or system, or to affect the safety or effectiveness of that device or system.

Life support devices or systems are intended to be implanted in the human body, or to support and/or maintain and sustain and/or protect human life. If they fail, it is reasonable to assume that the health of the user or other persons may be endangered.