

## 阅读申明

- 1.本站收集的数据手册和产品资料都来自互联网，版权归原作者所有。如读者和版权方有任何异议请及时告之，我们将妥善解决。
- 2.本站提供的中文数据手册是英文数据手册的中文翻译，其目的是协助用户阅读，该译文无法自动跟随原稿更新，同时也可能存在翻译上的不当。建议读者以英文原稿为参考以便获得更精准的信息。
- 3.本站提供的产品资料，来自厂商的技术支持或者使用者的心得体会等，其内容可能存在描述上的差异，建议读者做出适当判断。
- 4.如需与我们联系，请发邮件到marketing@iczoom.com，主题请标有“数据手册”字样。

## Read Statement

1. The datasheets and other product information on the site are all from network reference or other public materials, and the copyright belongs to the original author and original published source. If readers and copyright owners have any objections, please contact us and we will deal with it in a timely manner.
2. The Chinese datasheets provided on the website is a Chinese translation of the English datasheets. Its purpose is for reader's learning exchange only and do not involve commercial purposes. The translation cannot be automatically updated with the original manuscript, and there may also be improper translations. Readers are advised to use the English manuscript as a reference for more accurate information.
3. All product information provided on the website refer to solutions from manufacturers' technical support or users the contents may have differences in description, and readers are advised to take the original article as the standard.
4. If you have any questions, please contact us at marketing@iczoom.com and mark the subject with "Datasheets" .

# MUN2211T1 Series

Preferred Devices

## Bias Resistor Transistors

### NPN Silicon Surface Mount Transistors with Monolithic Bias Resistor Network

This new series of digital transistors is designed to replace a single device and its external resistor bias network. The BRT (Bias Resistor Transistor) contains a single transistor with a monolithic bias network consisting of two resistors; a series base resistor and a base-emitter resistor. The BRT eliminates these individual components by integrating them into a single device. The use of a BRT can reduce both system cost and board space. The device is housed in the SC-59 package which is designed for low power surface mount applications.

#### Features

- Simplifies Circuit Design
- Reduces Board Space
- Reduces Component Count
- Moisture Sensitivity Level: 1
- ESD Rating - Human Body Model: Class 1  
- Machine Model: Class B
- The SC-59 Package can be Soldered Using Wave or Reflow
- The Modified Gull-Winged Leads Absorb Thermal Stress During Soldering Eliminating the Possibility of Damage to the Die
- Pb-Free Packages are Available

#### MAXIMUM RATINGS ( $T_A = 25^\circ\text{C}$ unless otherwise noted)

Rating	Symbol	Value	Unit
Collector-Base Voltage	$V_{CB0}$	50	Vdc
Collector-Emitter Voltage	$V_{CEO}$	50	Vdc
Collector Current	$I_C$	100	mAdc

#### THERMAL CHARACTERISTICS

Characteristic	Symbol	Max	Unit
Total Device Dissipation $T_A = 25^\circ\text{C}$ Derate above $25^\circ\text{C}$	$P_D$	230 (Note 1) 338 (Note 2) 1.8 (Note 1) 2.7 (Note 2)	mW $^\circ\text{C}/\text{W}$
Thermal Resistance, Junction-to-Ambient	$R_{\theta JA}$	540 (Note 1) 370 (Note 2)	$^\circ\text{C}/\text{W}$
Thermal Resistance, Junction-to-Lead	$R_{\theta JL}$	264 (Note 1) 287 (Note 2)	$^\circ\text{C}/\text{W}$
Junction and Storage Temperature Range	$T_J, T_{stg}$	-55 to +150	$^\circ\text{C}$

Stresses exceeding Maximum Ratings may damage the device. Maximum Ratings are stress ratings only. Functional operation above the Recommended Operating Conditions is not implied. Extended exposure to stresses above the Recommended Operating Conditions may affect device reliability.

1. FR-4 @ Minimum Pad.
2. FR-4 @ 1.0 x 1.0 inch Pad.



ON Semiconductor®

<http://onsemi.com>

### NPN SILICON BIAS RESISTOR TRANSISTORS

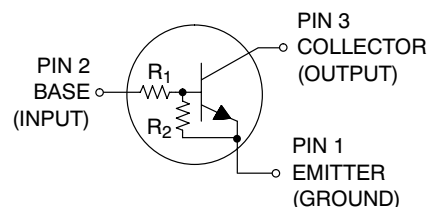

SC-59  
CASE 318D  
STYLE 1

#### MARKING DIAGRAM

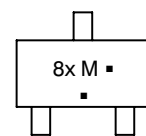

8x = Device Code (Refer to page 2)  
M = Date Code\*  
▪ = Pb-Free Package

(Note: Microdot may be in either location)  
\*Date Code orientation may vary depending upon manufacturing location.

#### ORDERING INFORMATION

See detailed ordering and shipping information in the table on page 2 of this data sheet.

#### DEVICE MARKING INFORMATION

See specific marking information in the Device Marking and Resistor Values table on page 2 of this data sheet.

Preferred devices are recommended choices for future use and best overall value.

## MUN2211T1 Series

### DEVICE MARKING AND RESISTOR VALUES

Device	Package	Marking	R1 (K)	R2 (K)	Shipping <sup>†</sup>
MUN2211T1	SC-59	8A	10	10	3000/Tape & Reel
MUN2211T1G	SC-59 (Pb-Free)	8A	10	10	3000/Tape & Reel
MUN2211T3	SC-59	8A	10	10	10,000/Tape & Reel
MUN2211T3G	SC-59 (Pb-Free)	8A	10	10	10,000/Tape & Reel
MUN2212T1	SC-59	8B	22	22	3000/Tape & Reel
MUN2212T1G	SC-59 (Pb-Free)	8B	22	22	3000/Tape & Reel
MUN2213T1	SC-59	8C	47	47	3000/Tape & Reel
MUN2213T1G	SC-59 (Pb-Free)	8C	47	47	3000/Tape & Reel
MUN2214T1	SC-59	8D	10	47	3000/Tape & Reel
MUN2214T1G	SC-59 (Pb-Free)	8D	10	47	3000/Tape & Reel
MUN2214T3	SC-59	8D	10	47	10,000/Tape & Reel
MUN2214T3G	SC-59 (Pb-Free)	8D	10	47	10,000/Tape & Reel
MUN2215T1	SC-59	8E	10	∞	3000/Tape & Reel
MUN2215T1G	SC-59 (Pb-Free)	8E	10	∞	3000/Tape & Reel
MUN2216T1	SC-59	8F	4.7	∞	3000/Tape & Reel
MUN2216T1G	SC-59 (Pb-Free)	8F	4.7	∞	3000/Tape & Reel
MUN2230T1	SC-59	8G	1.0	1.0	3000/Tape & Reel
MUN2230T1G	SC-59 (Pb-Free)	8G	1.0	1.0	3000/Tape & Reel
MUN2231T1 (Note 3)	SC-59	8H	2.2	2.2	3000/Tape & Reel
MUN2231T1G (Note 3)	SC-59 (Pb-Free)	8H	2.2	2.2	3000/Tape & Reel
MUN2232T1	SC-59	8J	4.7	4.7	3000/Tape & Reel
MUN2232T1G	SC-59 (Pb-Free)	8J	4.7	4.7	3000/Tape & Reel
MUN2233T1	SC-59	8K	4.7	47	3000/Tape & Reel
MUN2233T1G	SC-59 (Pb-Free)	8K	4.7	47	3000/Tape & Reel
MUN2234T1 (Note 3)	SC-59	8L	22	47	3000/Tape & Reel
MUN2234T1G (Note 3)	SC-59 (Pb-Free)	8L	22	47	3000/Tape & Reel
MUN2236T1	SC-59	8N	100	100	3000/Tape & Reel
MUN2236T1G	SC-59 (Pb-Free)	8N	100	100	3000/Tape & Reel
MUN2237T1	SC-59	8P	47	22	3000/Tape & Reel
MUN2237T1G	SC-59 (Pb-Free)	8P	47	22	3000/Tape & Reel
MUN2240T1 (Note 3)	SC-59	8T	47	∞	3000/Tape & Reel
MUN2240T1G (Note 3)	SC-59 (Pb-Free)	8T	47	∞	3000/Tape & Reel
MUN2241T1 (Note 3)	SC-59	8U	100	∞	3000/Tape & Reel
MUN2241T1G (Note 3)	SC-59 (Pb-Free)	8U	100	∞	3000/Tape & Reel

<sup>†</sup>For information on tape and reel specifications, including part orientation and tape sizes, please refer to our Tape and Reel Packaging Specifications Brochure, BRD8011/D.

3. New devices. Updated curves to follow in subsequent data sheets.

# MUN2211T1 Series

## ELECTRICAL CHARACTERISTICS (T<sub>A</sub> = 25°C unless otherwise noted)

Characteristic	Symbol	Min	Typ	Max	Unit
<b>OFF CHARACTERISTICS</b>					
Collector-Base Cutoff Current (V <sub>CB</sub> = 50 V, I <sub>E</sub> = 0)	I <sub>CBO</sub>	-	-	100	nAdc
Collector-Emitter Cutoff Current (V <sub>CE</sub> = 50 V, I <sub>B</sub> = 0)	I <sub>CEO</sub>	-	-	500	nAdc
Emitter-Base Cutoff Current (V <sub>EB</sub> = 6.0 V, I <sub>C</sub> = 0)	I <sub>EBO</sub>	-	-	0.5	mAdc
	MUN2211T1, G	-	-	0.2	
	MUN2212T1, G	-	-	0.1	
	MUN2213T1, G	-	-	0.2	
	MUN2214T1, G	-	-	0.9	
	MUN2215T1, G	-	-	1.9	
	MUN2216T1, G	-	-	4.3	
	MUN2230T1, G	-	-	2.3	
	MUN2231T1, G	-	-	1.5	
	MUN2232T1, G	-	-	0.18	
	MUN2233T1, G	-	-	0.13	
	MUN2234T1, G	-	-	0.05	
	MUN2236T1, G	-	-	0.13	
	MUN2237T1, G	-	-	0.2	
	MUN2240T1, G	-	-	0.1	
	MUN2241T1, G	-	-	-	
Collector-Base Breakdown Voltage (I <sub>C</sub> = 10 μA, I <sub>E</sub> = 0)	V <sub>(BR)CBO</sub>	50	-	-	Vdc
Collector-Emitter Breakdown Voltage (Note 4) (I <sub>C</sub> = 2.0 mA, I <sub>B</sub> = 0)	V <sub>(BR)CEO</sub>	50	-	-	Vdc

## ON CHARACTERISTICS (Note 4)

DC Current Gain (V <sub>CE</sub> = 10 V, I <sub>C</sub> = 5.0 mA)	h <sub>FE</sub>	35	60	-	
	MUN2211T1, G	60	100	-	
	MUN2212T1, G	80	140	-	
	MUN2213T1, G	80	140	-	
	MUN2214T1, G	160	350	-	
	MUN2215T1, G	160	350	-	
	MUN2216T1, G	3.0	5.0	-	
	MUN2230T1, G	8.0	15	-	
	MUN2231T1, G	15	30	-	
	MUN2232T1, G	80	200	-	
	MUN2233T1, G	80	150	-	
	MUN2234T1, G	80	150	-	
	MUN2236T1, G	80	140	-	
	MUN2237T1, G	160	350	-	
	MUN2240T1, G	160	350	-	
	MUN2241T1, G	-	-	-	
Collector-Emitter Saturation Voltage (I <sub>C</sub> = 10 mA, I <sub>B</sub> = 0.3 mA)	V <sub>CE(sat)</sub>	-	-	0.25	Vdc
	MUN2211T1, G	-	-	0.25	
	MUN2212T1, G	-	-	0.25	
	MUN2213T1, G	-	-	0.25	
	MUN2214T1, G	-	-	0.25	
	MUN2233T1, G	-	-	0.25	
	MUN2236T1, G	-	-	0.25	
(I <sub>C</sub> = 10 mA, I <sub>B</sub> = 5 mA)	MUN2230T1, G	-	-	0.25	
	MUN2231T1, G	-	-	0.25	
	MUN2237T1, G	-	-	0.25	
	MUN2241T1, G	-	-	0.25	
(I <sub>C</sub> = 10 mA, I <sub>B</sub> = 1 mA)	MUN2215T1, G	-	-	0.25	
	MUN2216T1, G	-	-	0.25	
	MUN2232T1, G	-	-	0.25	
	MUN2234T1, G	-	-	0.25	
	MUN2240T1, G	-	-	0.25	

4. Pulse Test: Pulse Width < 300 μs, Duty Cycle < 2.0%.

# MUN2211T1 Series

## ELECTRICAL CHARACTERISTICS (T<sub>A</sub> = 25°C unless otherwise noted) (Continued)

Characteristic	Symbol	Min	Typ	Max	Unit	
<b>ON CHARACTERISTICS</b> (Note 5) (Continued)						
Output Voltage (on) (V <sub>CC</sub> = 5.0 V, V <sub>B</sub> = 2.5 V, R <sub>L</sub> = 1.0 kΩ)	MUN2211T1, G MUN2212T1, G MUN2214T1, G MUN2215T1, G MUN2216T1, G MUN2230T1, G MUN2231T1, G MUN2232T1, G MUN2233T1, G MUN2234T1, G (V <sub>CC</sub> = 5.0 V, V <sub>B</sub> = 3.5 V, R <sub>L</sub> = 1.0 kΩ) MUN2213T1, G MUN2240T1, G (V <sub>CC</sub> = 5.0 V, V <sub>B</sub> = 5.5 V, R <sub>L</sub> = 1.0 kΩ) MUN2236T1, G (V <sub>CC</sub> = 5.0 V, V <sub>B</sub> = 4.0 V, R <sub>L</sub> = 1.0 kΩ) MUN2237T1, G (V <sub>CC</sub> = 5.0 V, V <sub>B</sub> = 5.0 V, R <sub>L</sub> = 1.0 kΩ) MUN2241T1, G	V <sub>OL</sub>	-	-	0.2	Vdc
Output Voltage (off) (V <sub>CC</sub> = 5.0 V, V <sub>B</sub> = 0.5 V, R <sub>L</sub> = 1.0 kΩ)	MUN2211T1, G MUN2212T1, G MUN2213T1, G MUN2214T1, G MUN2233T1, G MUN2234T1, G (V <sub>CC</sub> = 5.0 V, V <sub>B</sub> = 0.050 V, R <sub>L</sub> = 1.0 kΩ) MUN2230T1, G (V <sub>CC</sub> = 5.0 V, V <sub>B</sub> = 0.25 V, R <sub>L</sub> = 1.0 kΩ) MUN2215T1, G MUN2216T1, G MUN2231T1, G MUN2232T1, G MUN2236T1, G MUN2237T1, G MUN2240T1, G MUN2241T1, G	V <sub>OH</sub>	4.9	-	-	Vdc
Input Resistor	MUN2211T1, G MUN2212T1, G MUN2213T1, G MUN2214T1, G MUN2215T1, G MUN2216T1, G MUN2230T1, G MUN2231T1, G MUN2232T1, G MUN2233T1, G MUN2234T1, G MUN2236T1, G MUN2237T1, G MUN2240T1, G MUN2241T1, G	R <sub>1</sub>	7.0 15.4 32.9 7.0 7.0 3.3 0.7 1.5 3.3 3.3 15.4 70 32.9 32.9 70	10 22 47 10 10 4.7 1.0 2.2 4.7 4.7 22 100 47 47 100	13 28.6 61.1 13 13 6.1 1.3 2.9 6.1 6.1 28.6 130 61.1 61.1 130	kΩ
Resistor Ratio	MUN2211T1, G MUN2212T1, G MUN2213T1, G MUN2214T1, G MUN2215T1, G MUN2216T1, G MUN2230T1, G MUN2231T1, G MUN2232T1, G MUN2233T1, G MUN2234T1, G MUN2236T1, G MUN2237T1, G MUN2240T1, G MUN2241T1, G	R <sub>1</sub> /R <sub>2</sub>	0.8 0.8 0.8 0.17 - - 0.8 0.8 0.8 0.8 0.055 0.38 0.8 1.7 - -	1.0 1.0 1.0 0.21 - - 1.0 1.0 1.0 1.0 0.12 0.47 1.0 2.15 - -	1.2 1.2 1.2 0.25 - - 1.2 1.2 1.2 1.2 0.185 0.56 1.2 2.6 - -	

5. Pulse Test: Pulse Width < 300 μs, Duty Cycle < 2.0%.

# MUN2211T1 Series

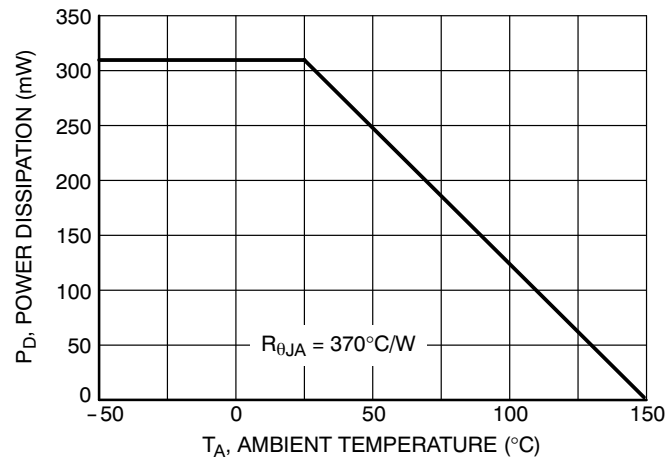

Figure 1. Derating Curve

# MUN2211T1 Series

## TYPICAL ELECTRICAL CHARACTERISTICS - MUN2211T1

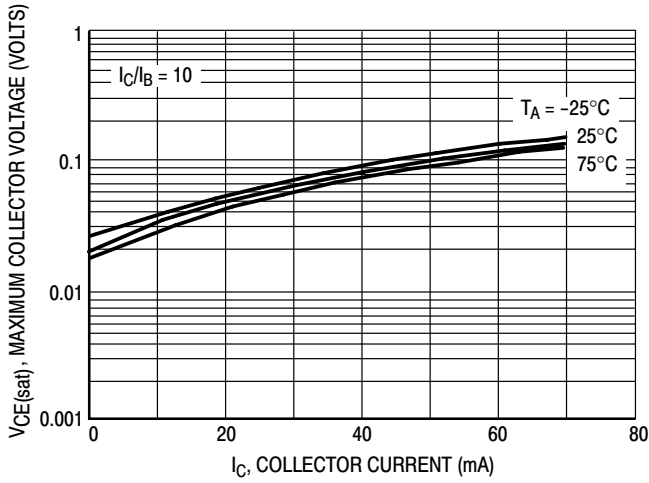

Figure 2.  $V_{CE(sat)}$  versus  $I_C$

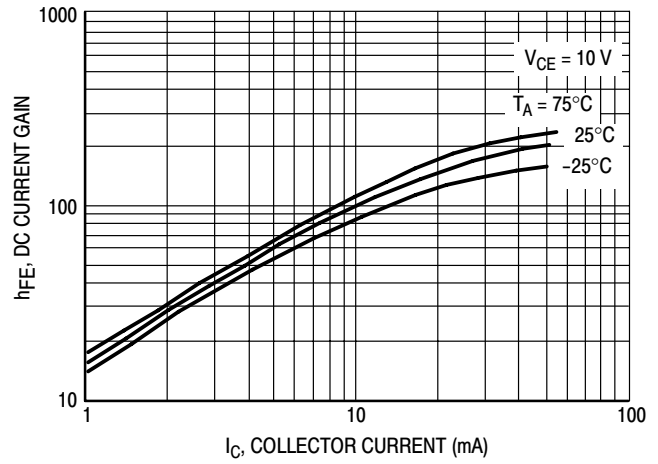

Figure 3. DC Current Gain

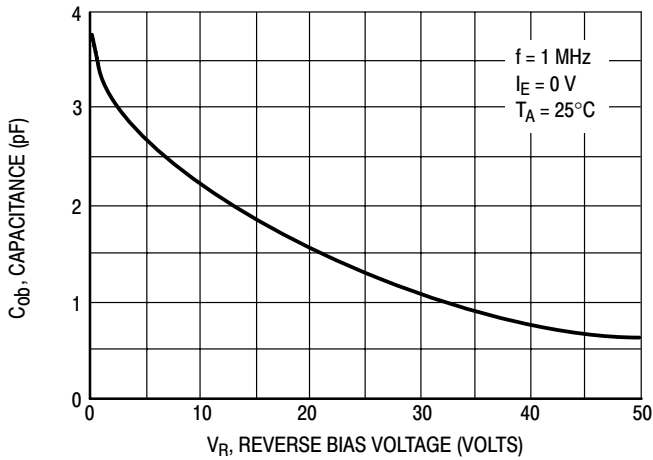

Figure 4. Output Capacitance

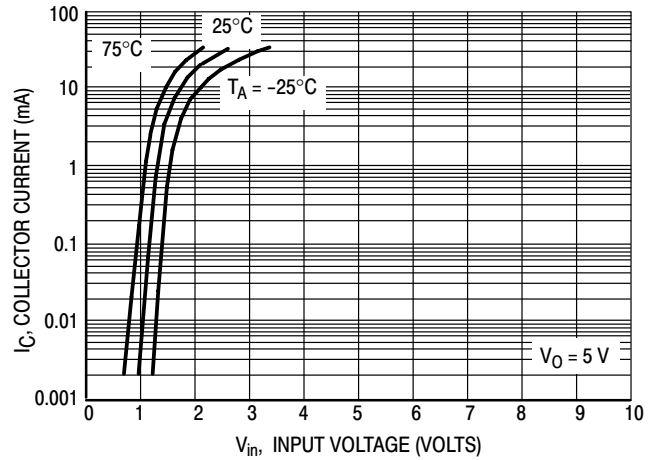

Figure 5. Output Current versus Input Voltage

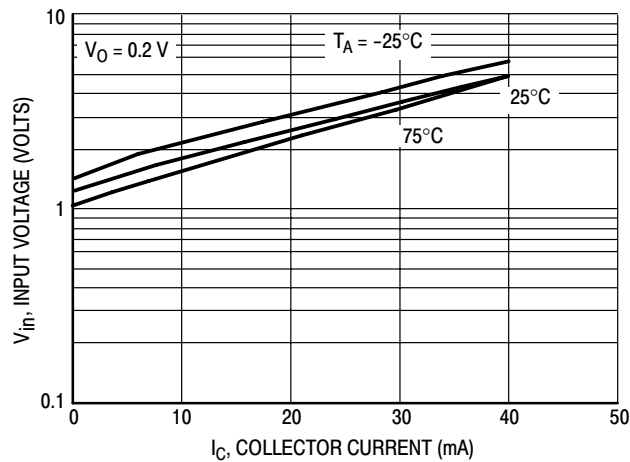

Figure 6. Input Voltage versus Output Current

# MUN2211T1 Series

## TYPICAL ELECTRICAL CHARACTERISTICS - MUN2212T1

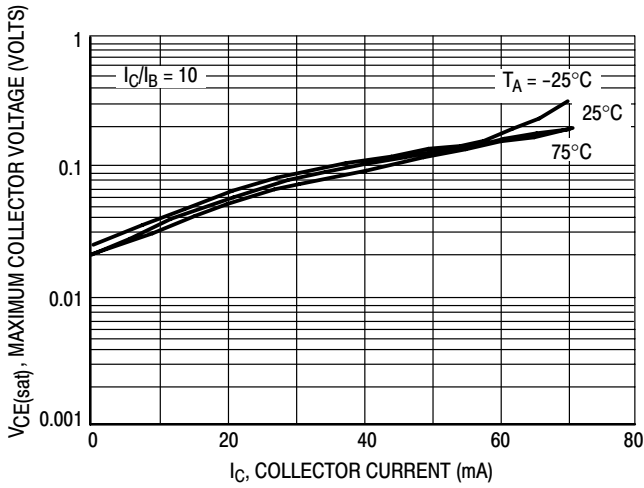

Figure 7.  $V_{CE(sat)}$  versus  $I_C$

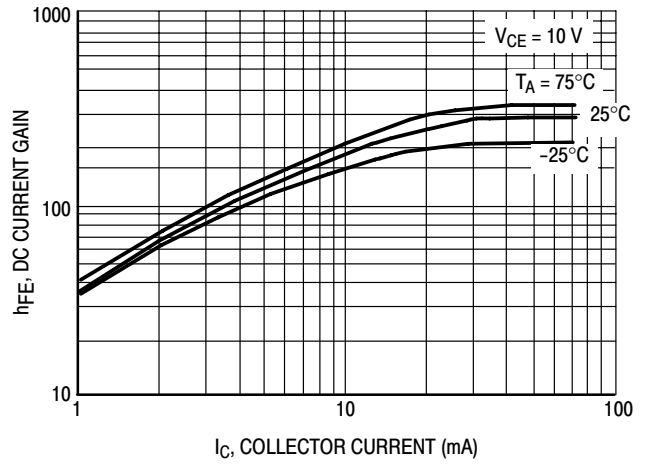

Figure 8. DC Current Gain

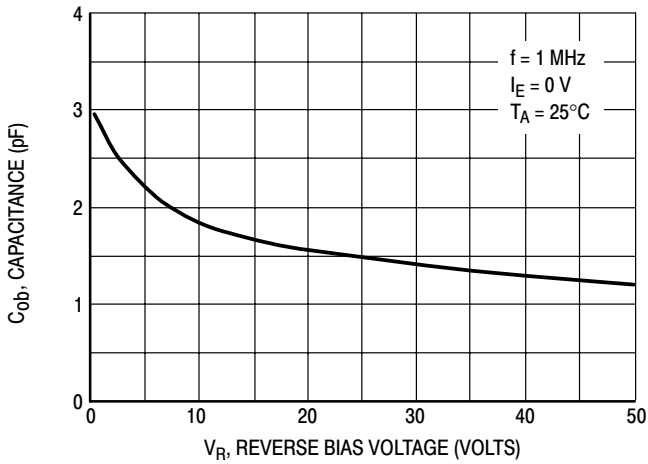

Figure 9. Output Capacitance

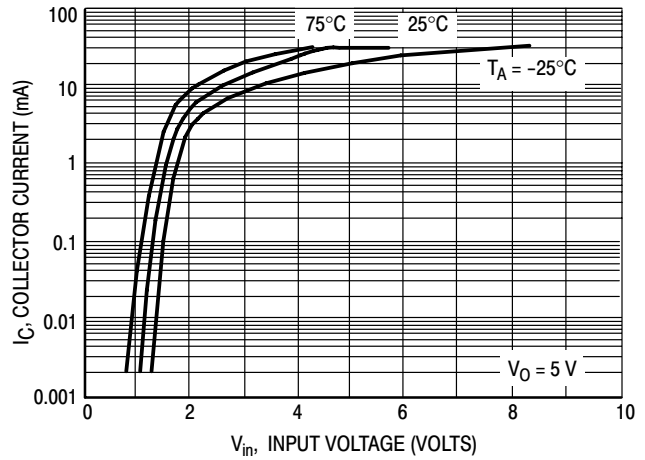

Figure 10. Output Current versus Input Voltage

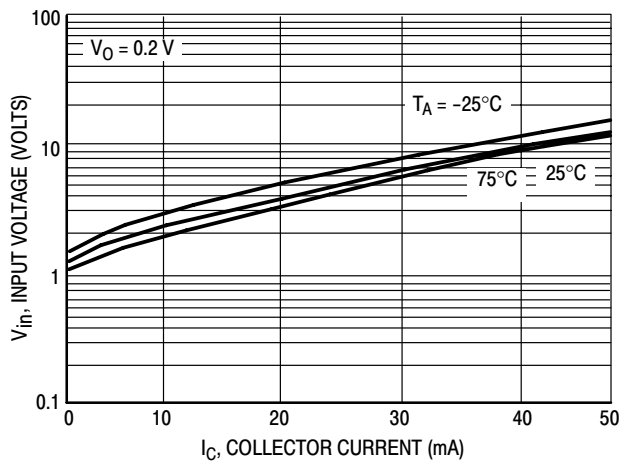

Figure 11. Input Voltage versus Output Current



# MUN2211T1 Series

## TYPICAL ELECTRICAL CHARACTERISTICS - MUN2213T1

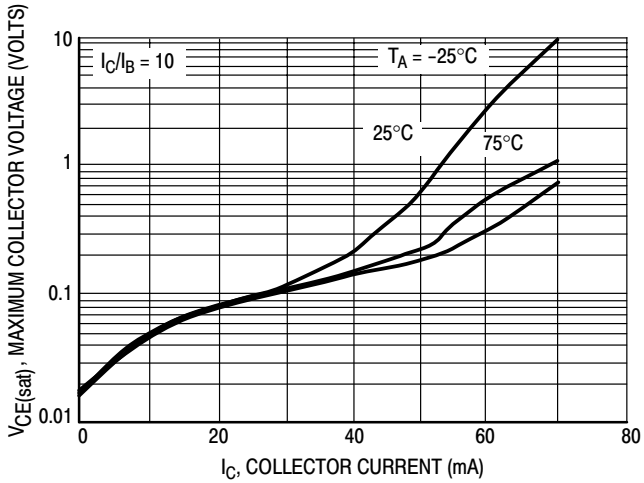

Figure 12.  $V_{CE(sat)}$  versus  $I_C$

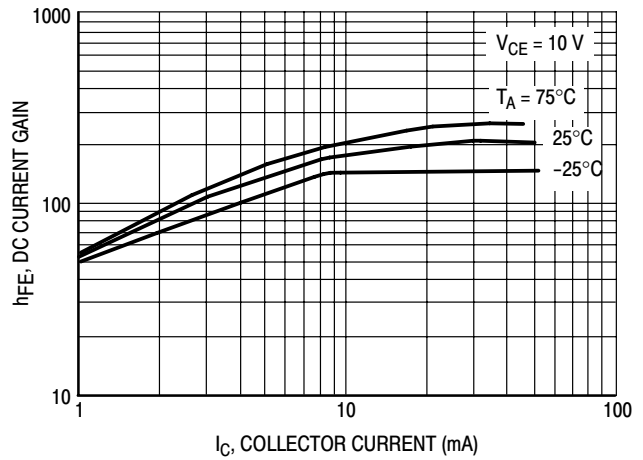

Figure 13. DC Current Gain

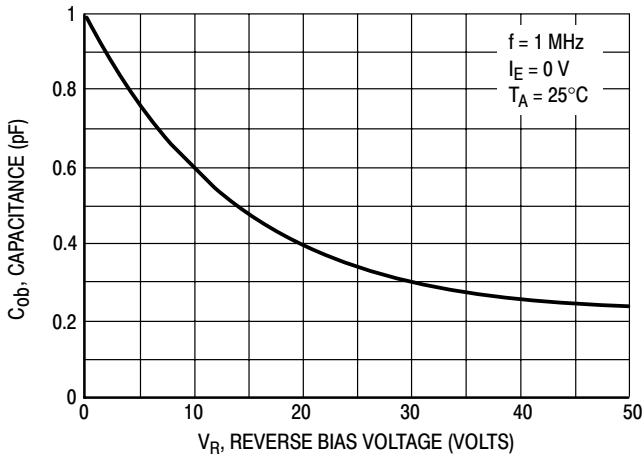

Figure 14. Output Capacitance

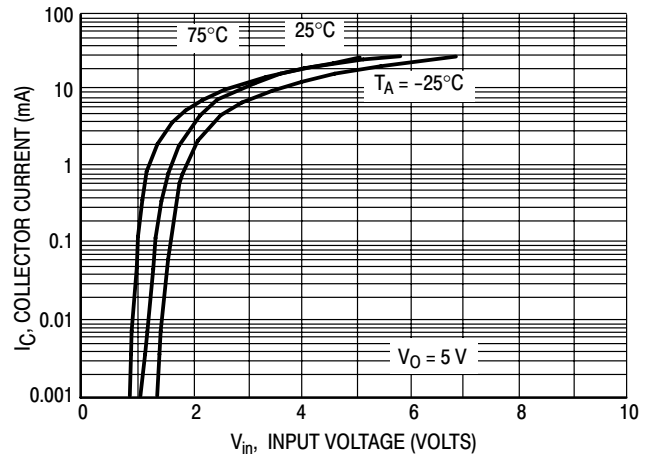

Figure 15. Output Current versus Input Voltage

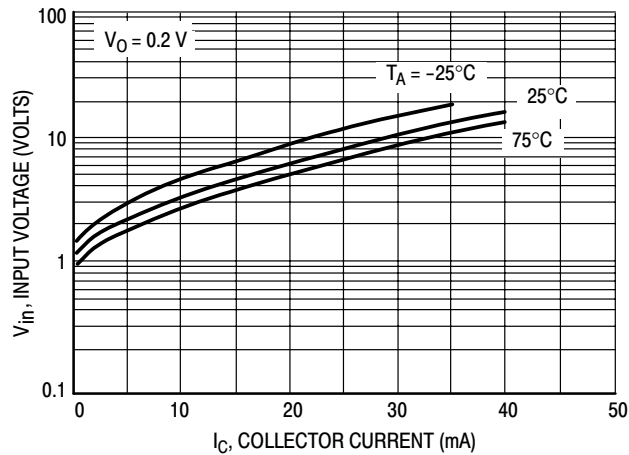

Figure 16. Input Voltage versus Output Current

# MUN221T1 Series

## TYPICAL ELECTRICAL CHARACTERISTICS - MUN2214T1

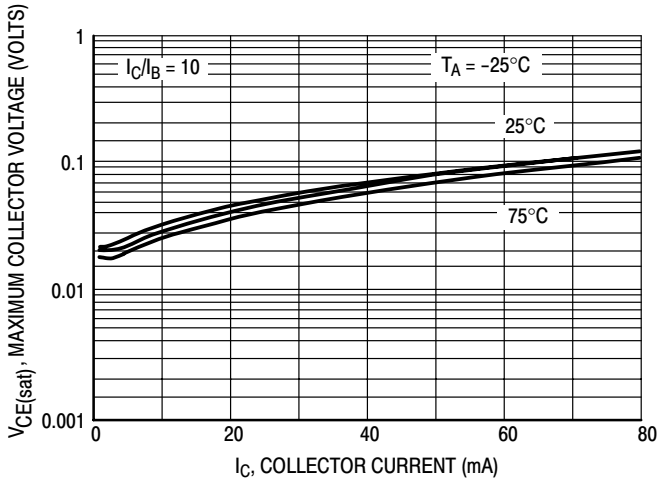

Figure 17.  $V_{CE(sat)}$  versus  $I_C$

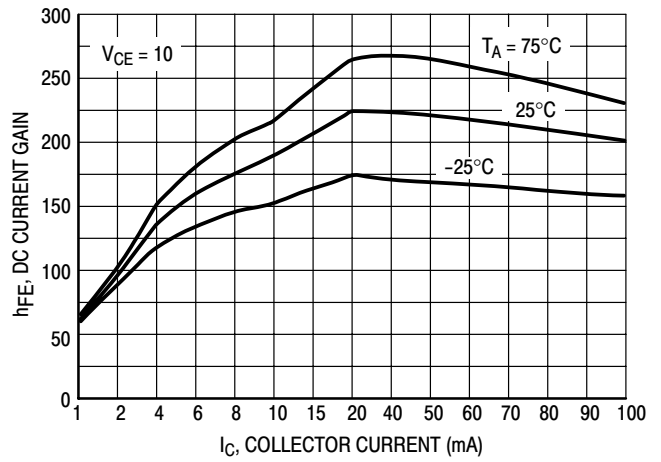

Figure 18. DC Current Gain

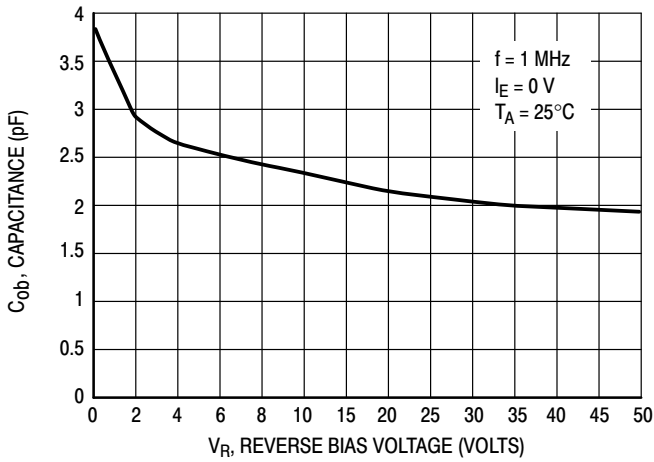

Figure 19. Output Capacitance

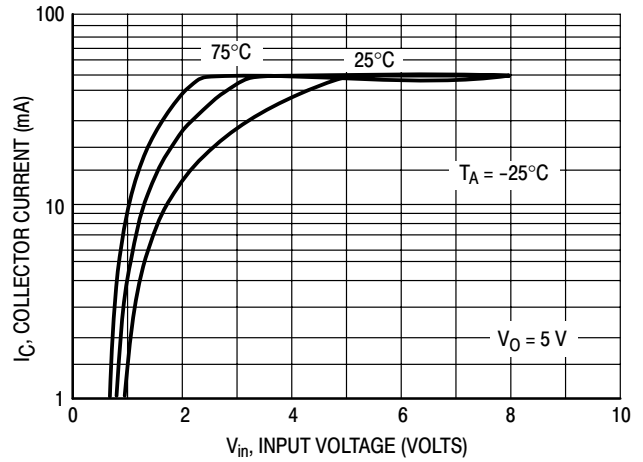

Figure 20. Output Current versus Input Voltage

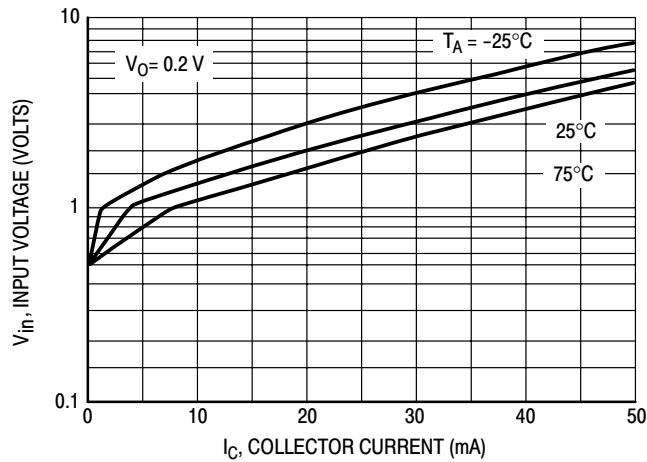

Figure 21. Input Voltage versus Output Current

# MUN2211T1 Series

## TYPICAL ELECTRICAL CHARACTERISTICS — MUN2215T1

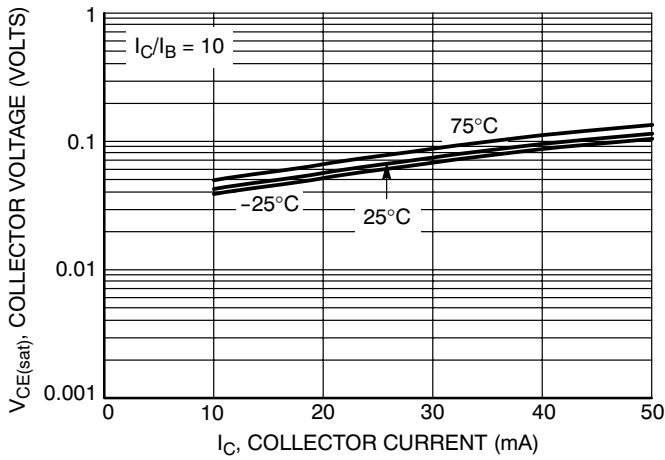

Figure 22.  $V_{CE(sat)}$  versus  $I_C$

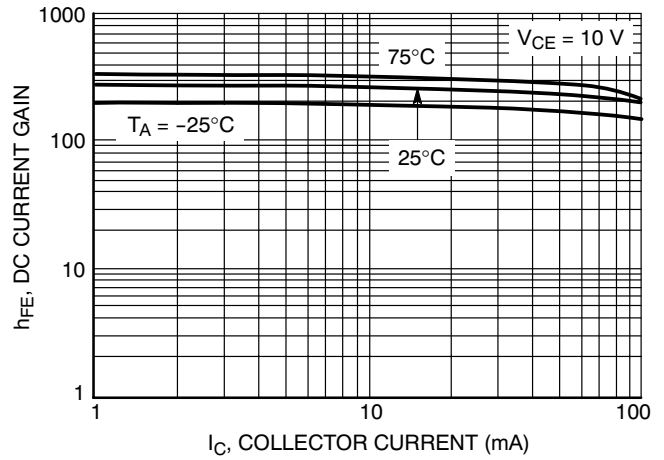

Figure 23. DC Current Gain

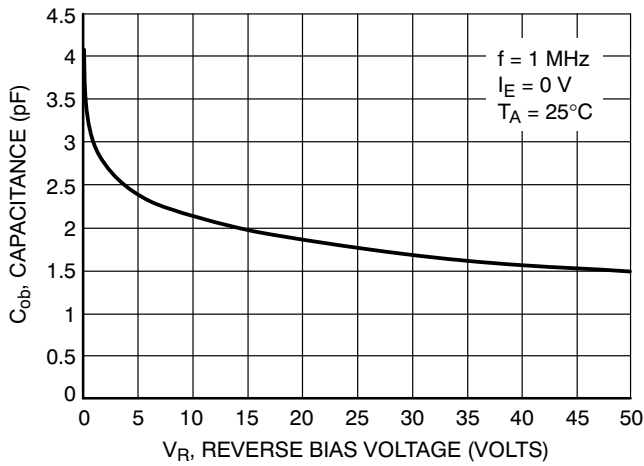

Figure 24. Output Capacitance

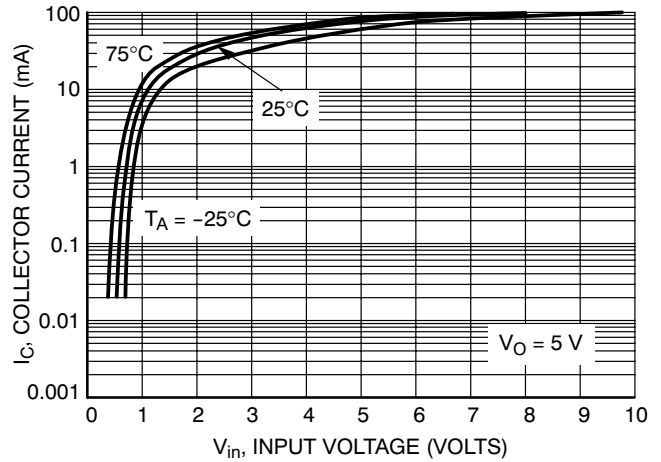

Figure 25. Output Current versus Input Voltage

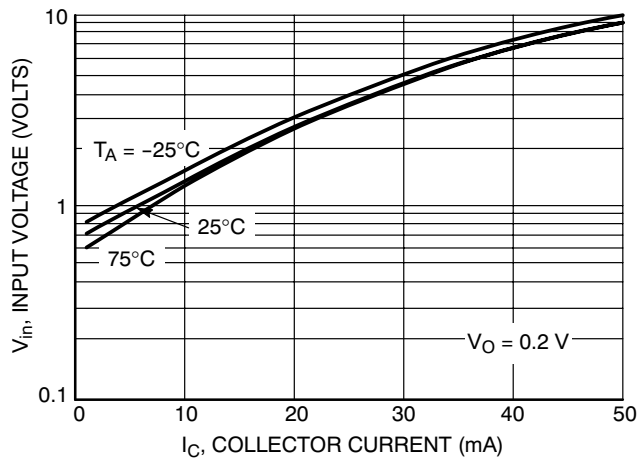

Figure 26. Input Voltage versus Output Current

# MUN2211T1 Series

## TYPICAL ELECTRICAL CHARACTERISTICS — MUN2216T1

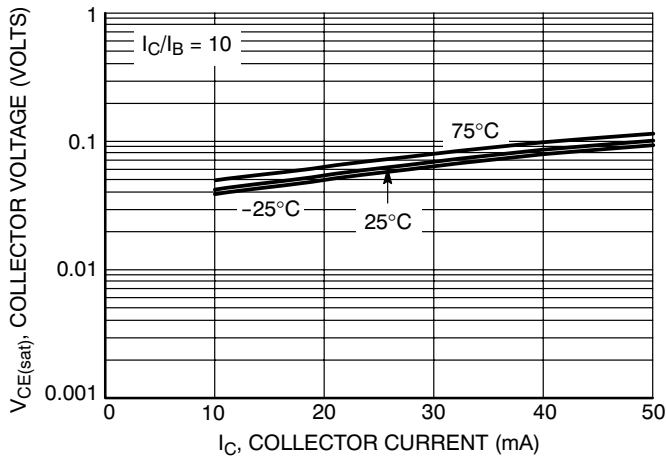

Figure 27.  $V_{CE(sat)}$  versus  $I_C$

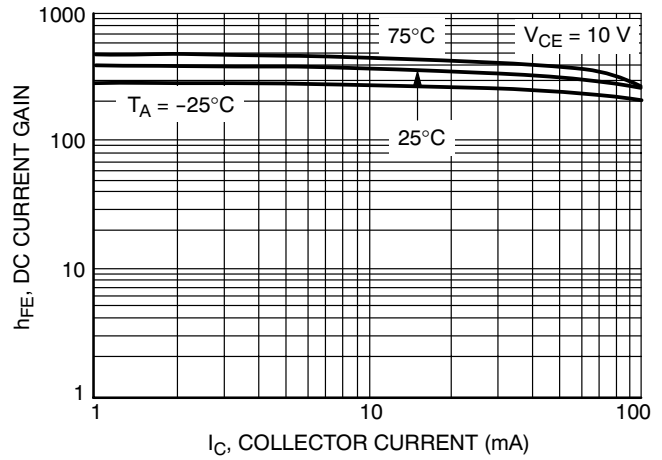

Figure 28. DC Current Gain

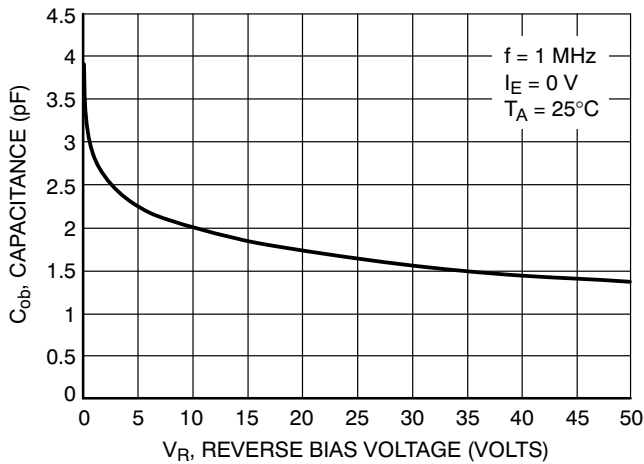

Figure 29. Output Capacitance

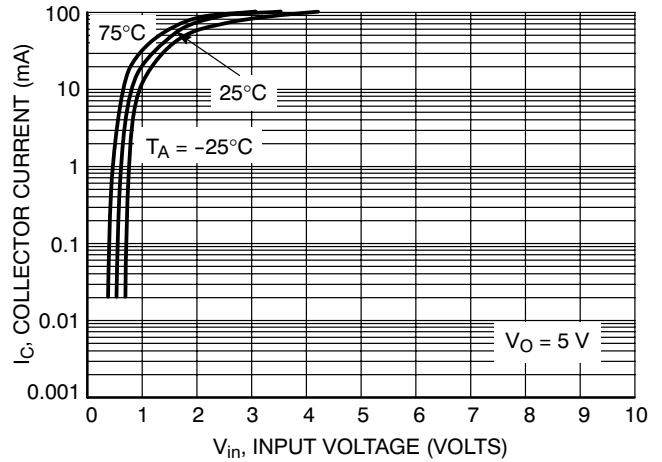

Figure 30. Output Current versus Input Voltage

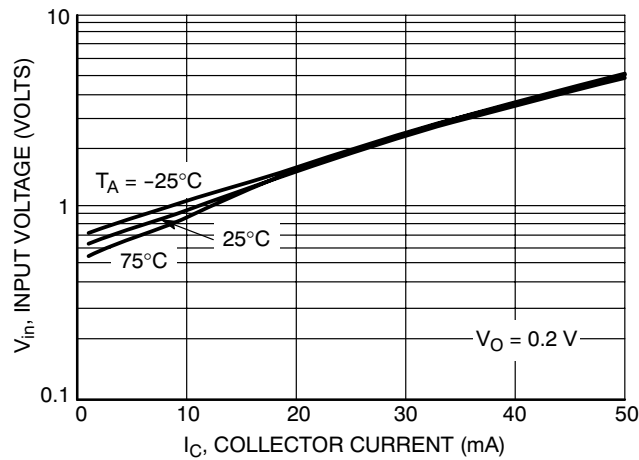

Figure 31. Input Voltage versus Output Current

# MUN2211T1 Series

## TYPICAL ELECTRICAL CHARACTERISTICS — MUN2230T1

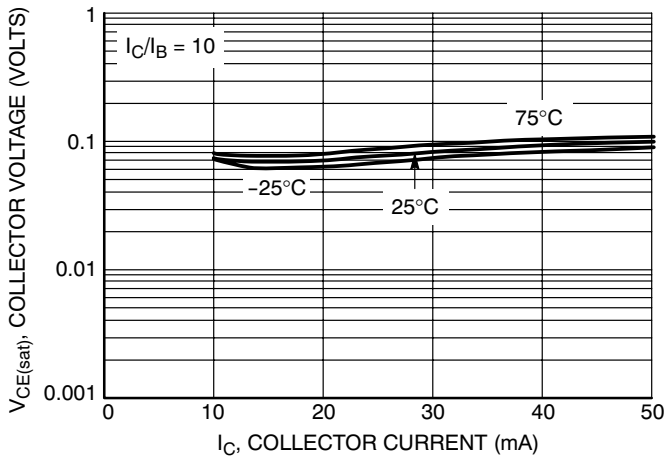

Figure 32.  $V_{CE(sat)}$  versus  $I_C$

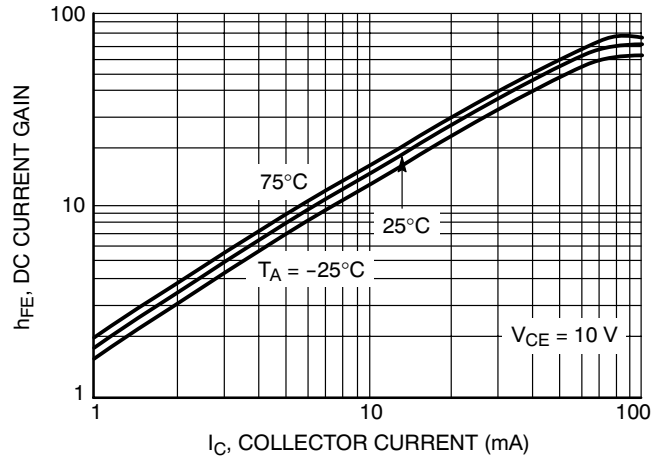

Figure 33. DC Current Gain

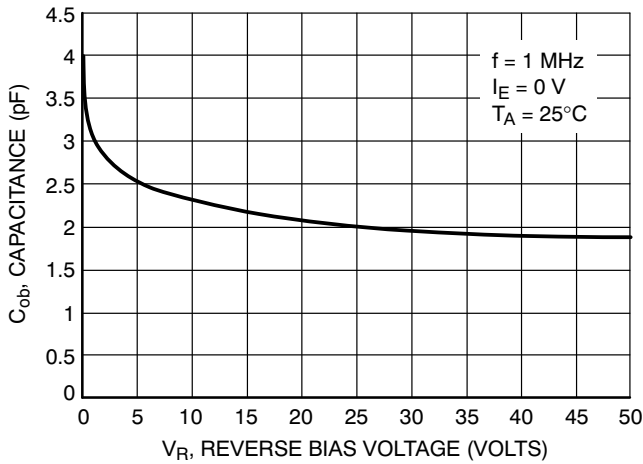

Figure 34. Output Capacitance

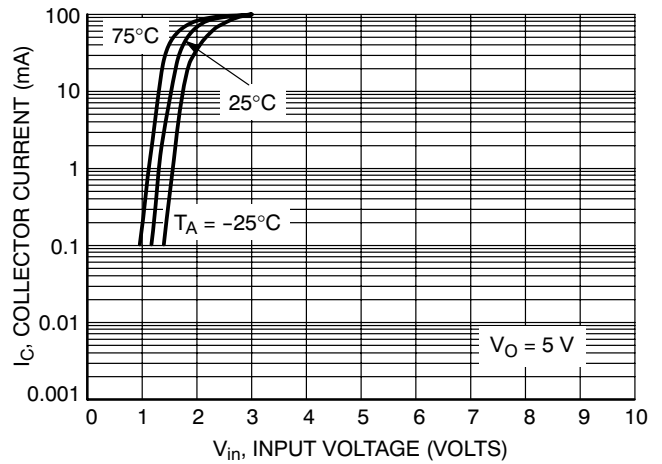

Figure 35. Output Current versus Input Voltage

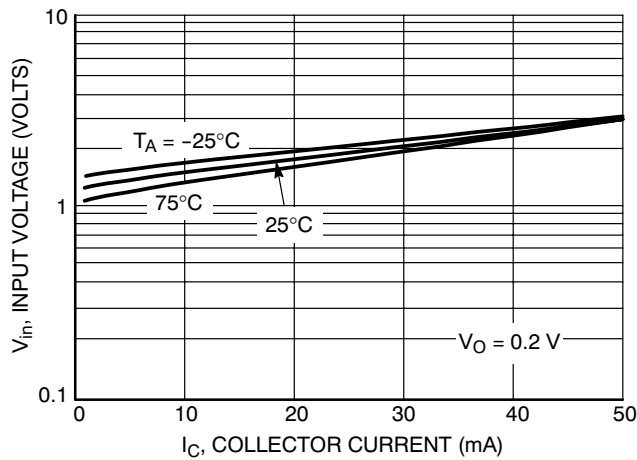

Figure 36. Input Voltage versus Output Current

# MUN2211T1 Series

## TYPICAL ELECTRICAL CHARACTERISTICS — MUN2232T1

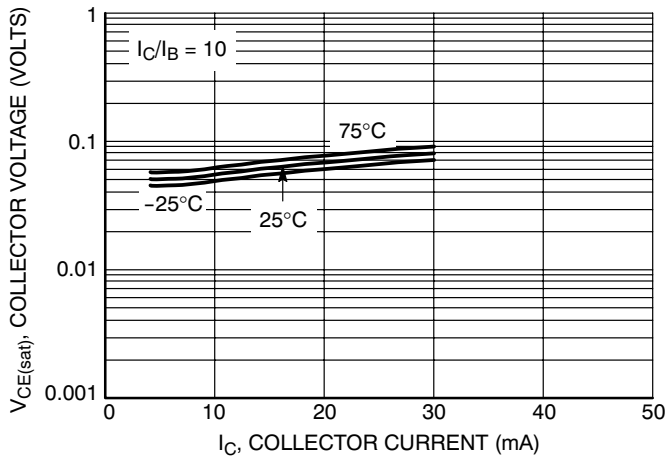

Figure 37.  $V_{CE(sat)}$  versus  $I_C$

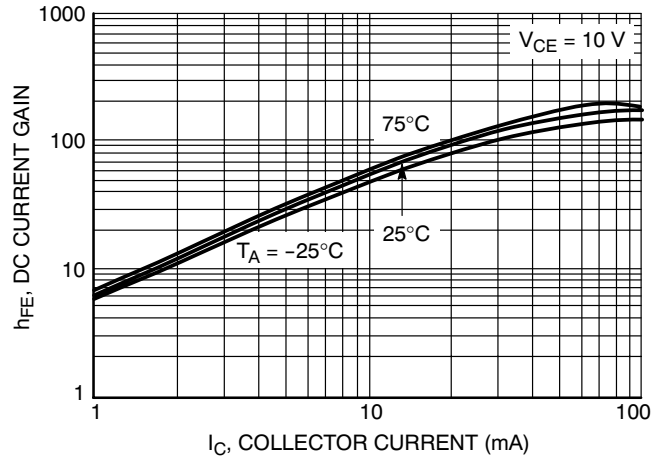

Figure 38. DC Current Gain

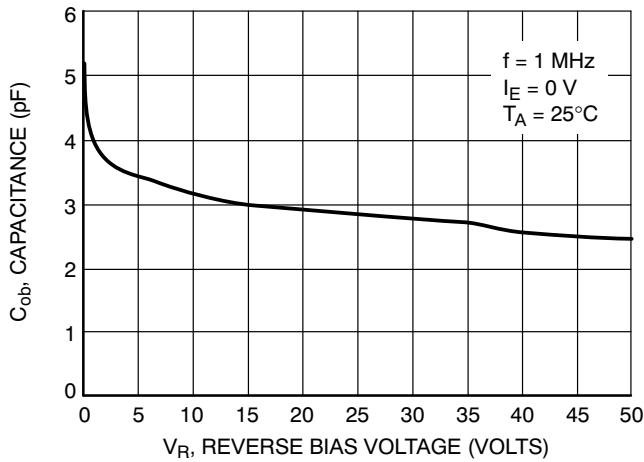

Figure 39. Output Capacitance

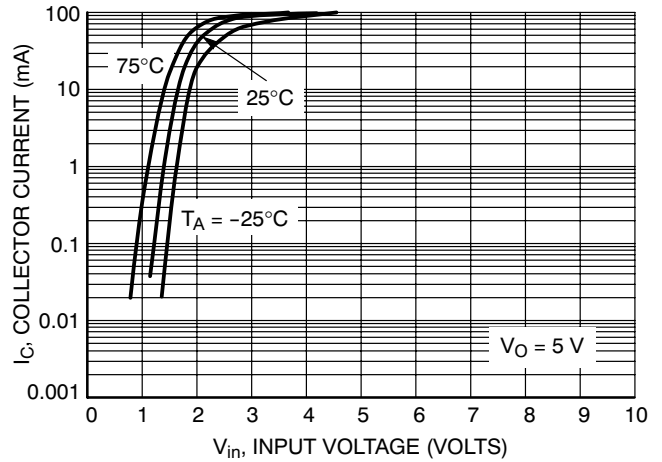

Figure 40. Output Current versus Input Voltage

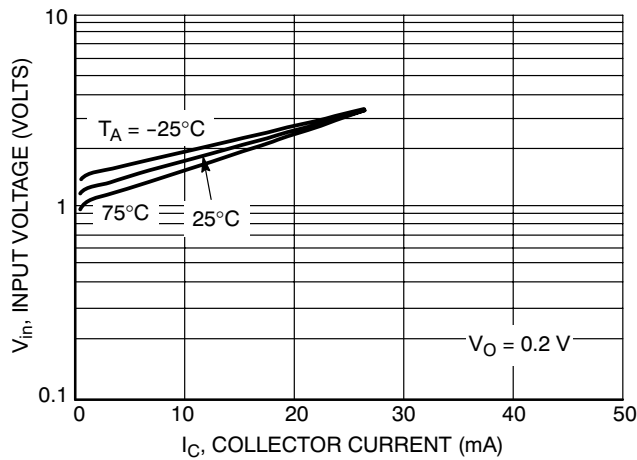

Figure 41. Input Voltage versus Output Current

# MUN2211T1 Series

## TYPICAL ELECTRICAL CHARACTERISTICS — MUN2233T1

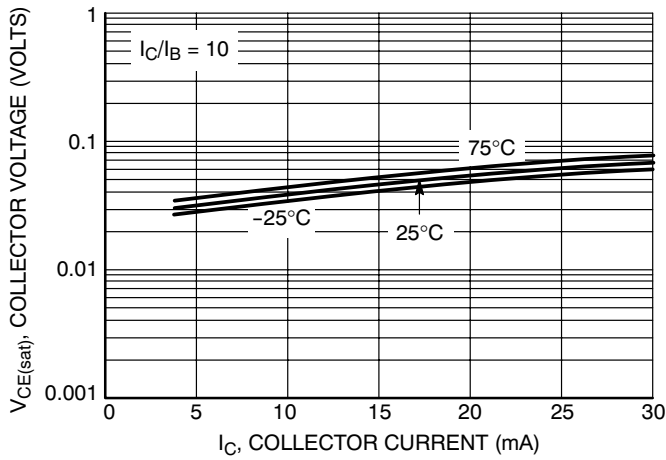

Figure 42.  $V_{CE(sat)}$  versus  $I_C$

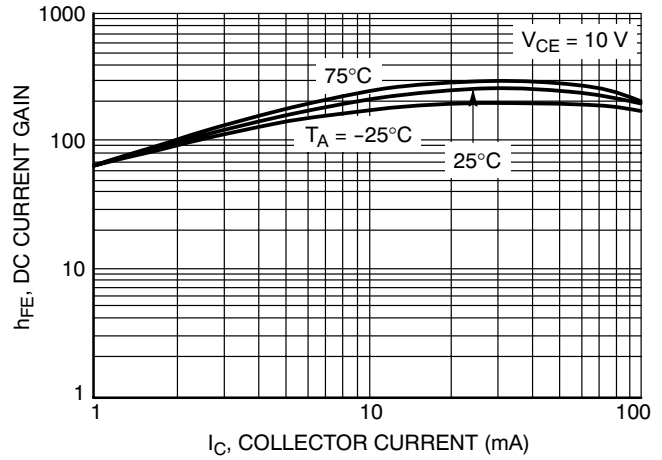

Figure 43. DC Current Gain

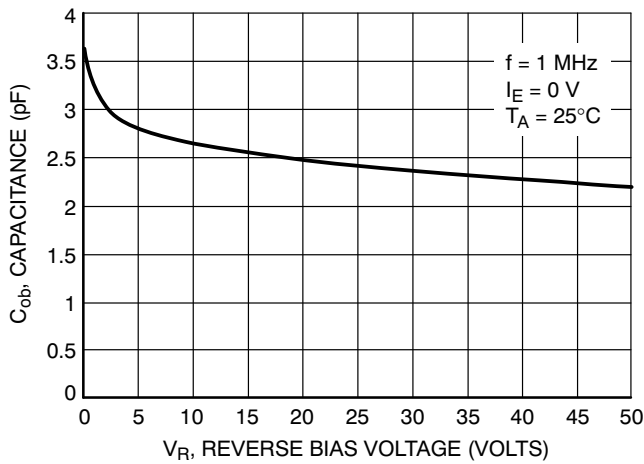

Figure 44. Output Capacitance

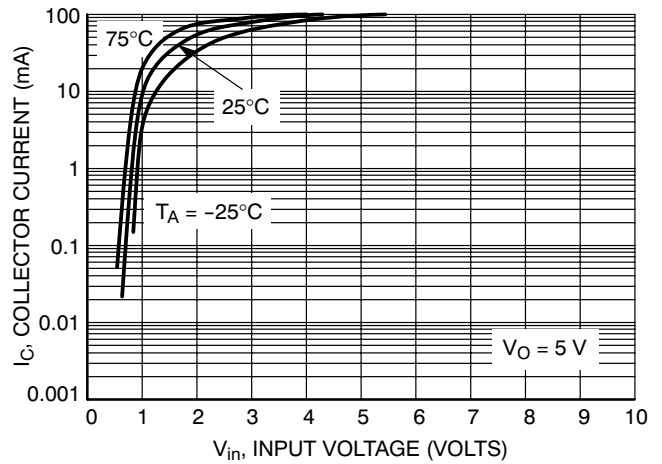

Figure 45. Output Current versus Input Voltage

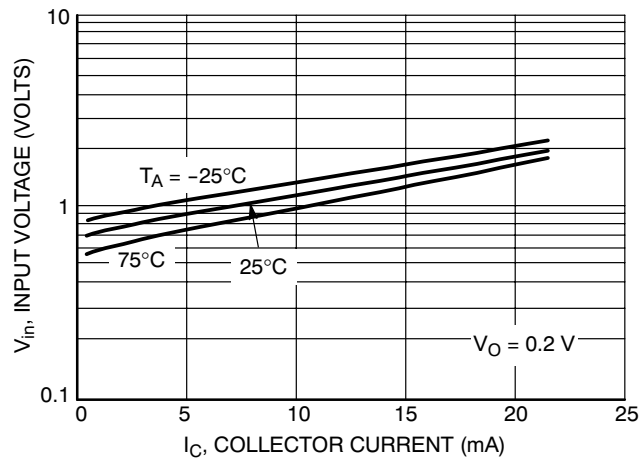

Figure 46. Input Voltage versus Output Current

# MUN2211T1 Series

## TYPICAL ELECTRICAL CHARACTERISTICS - MUN2236T1

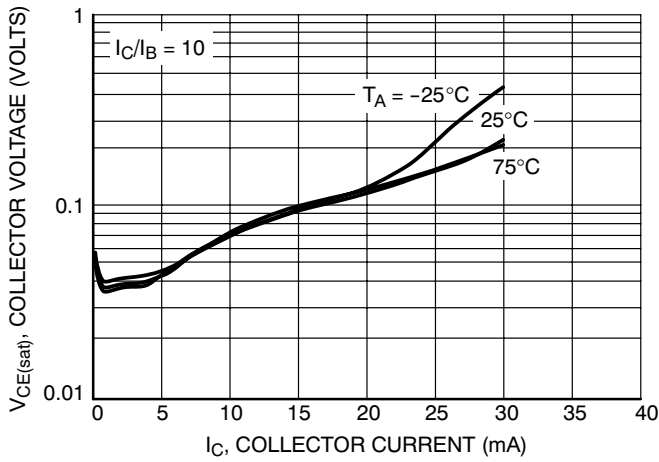

Figure 47.  $V_{CE(sat)}$  versus  $I_C$

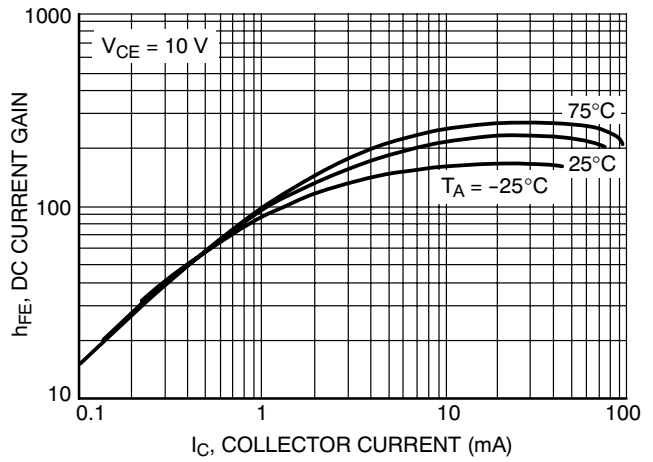

Figure 48. DC Current Gain

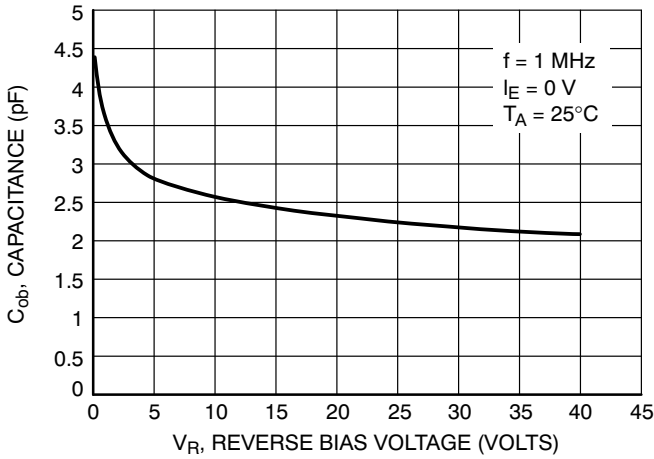

Figure 49. Output Capacitance

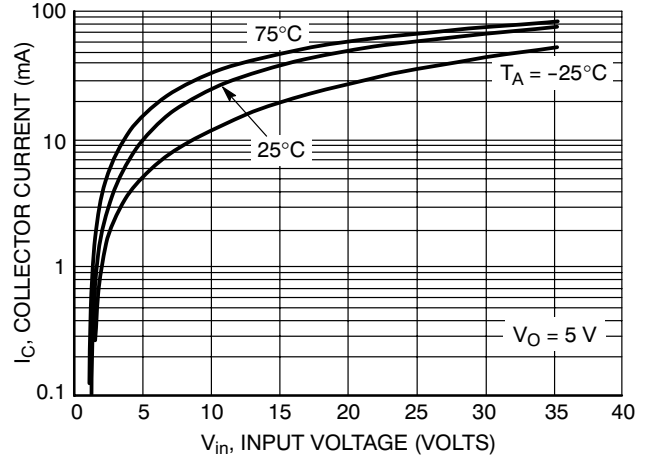

Figure 50. Output Current versus Input Voltage

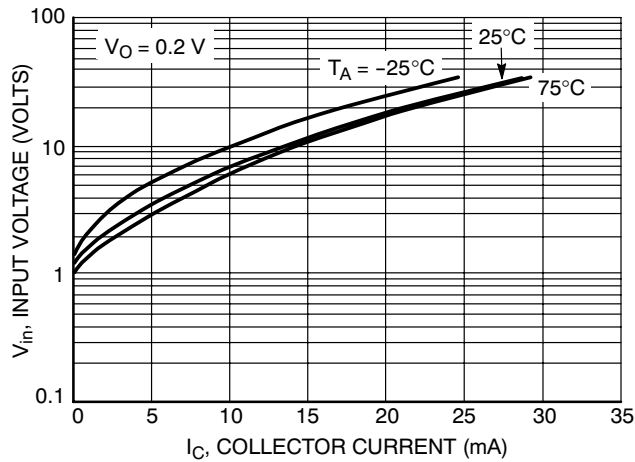

Figure 51. Input Voltage versus Output Current



# MUN2211T1 Series

## TYPICAL ELECTRICAL CHARACTERISTICS - MUN2237T1

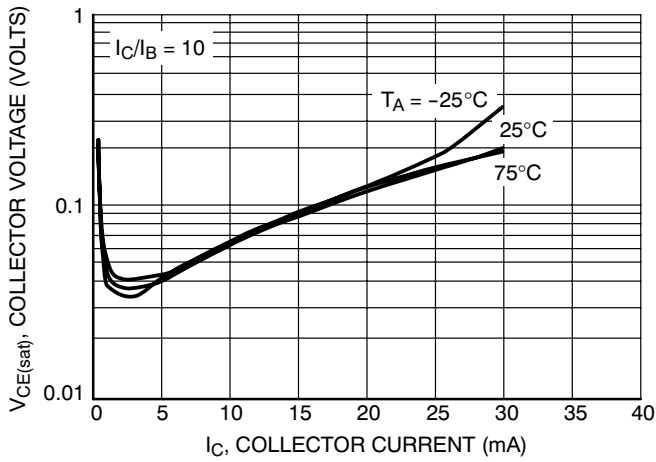

Figure 52.  $V_{CE(sat)}$  versus  $I_C$

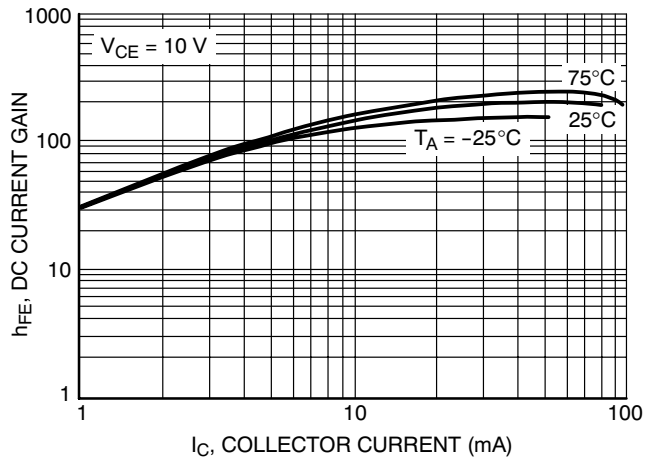

Figure 53. DC Current Gain

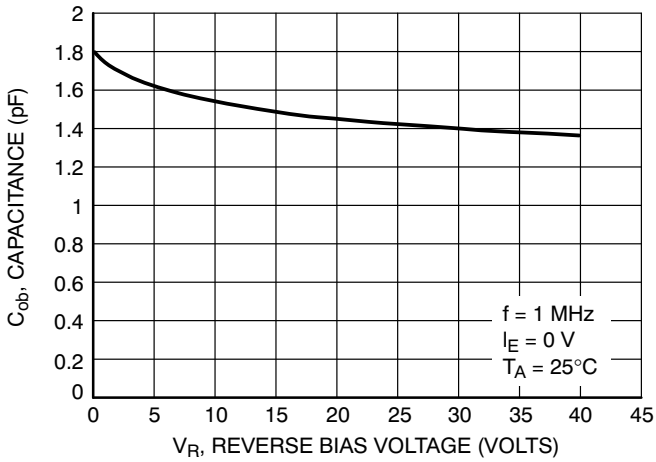

Figure 54. Output Capacitance

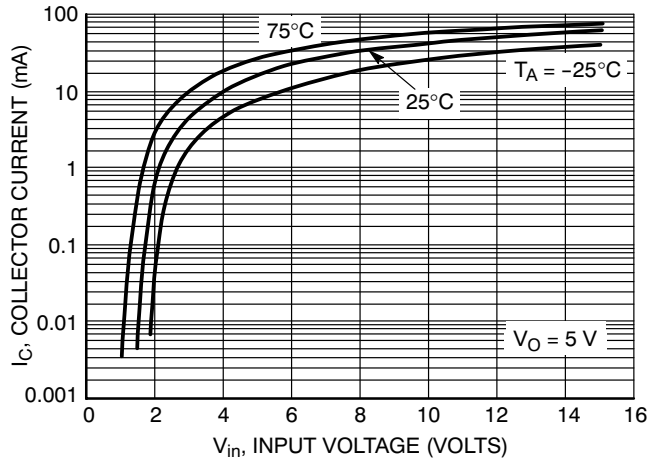

Figure 55. Output Current versus Input Voltage

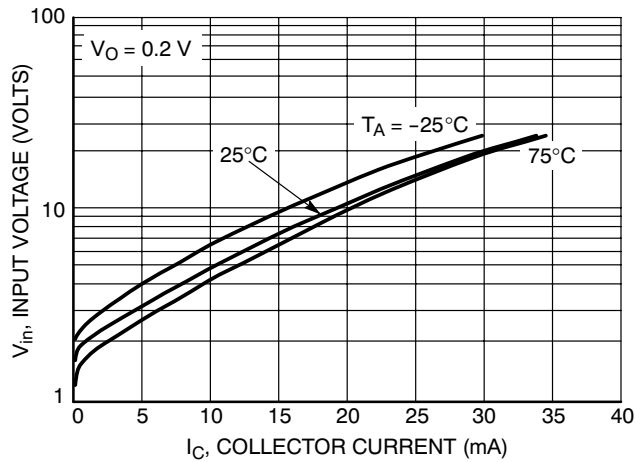

Figure 56. Input Voltage versus Output Current

# MUN2211T1 Series

## TYPICAL APPLICATIONS FOR NPN BRTs

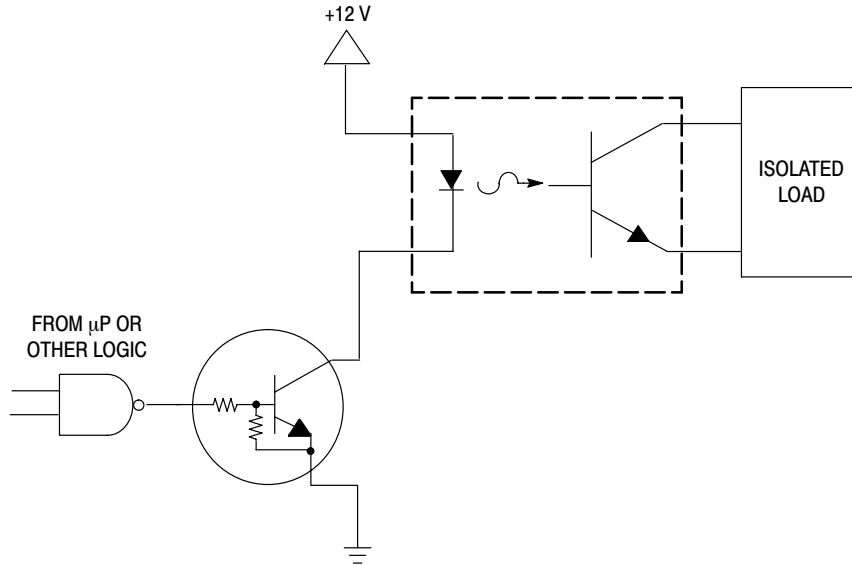

Figure 57. Level Shifter: Connects 12 or 24 Volt Circuits to Logic

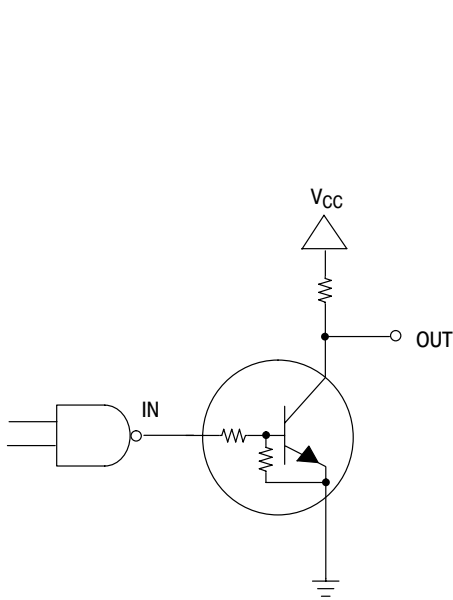

Figure 58. Open Collector Inverter:  
Inverts the Input Signal

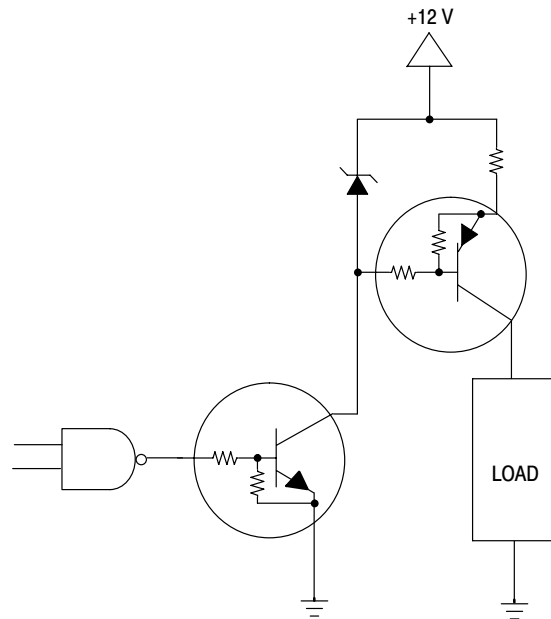
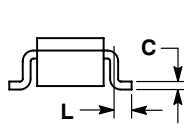
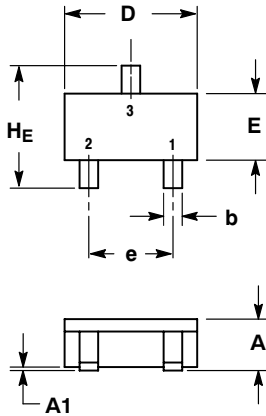

Figure 59. Inexpensive, Unregulated Current Source

# MUN2211T1 Series

## PACKAGE DIMENSIONS

SC-59  
CASE 318D-04  
ISSUE G



NOTES:

1. DIMENSIONING AND TOLERANCING PER ANSI Y14.5M, 1982.
2. CONTROLLING DIMENSION: MILLIMETER.

DIM	MILLIMETERS			INCHES		
	MIN	NOM	MAX	MIN	NOM	MAX
A	1.00	1.15	1.30	0.039	0.045	0.051
A1	0.01	0.06	0.10	0.001	0.002	0.004
b	0.35	0.43	0.50	0.014	0.017	0.020
c	0.09	0.14	0.18	0.003	0.005	0.007
D	2.70	2.90	3.10	0.106	0.114	0.122
E	1.30	1.50	1.70	0.051	0.059	0.067
e	1.70	1.90	2.10	0.067	0.075	0.083
L	0.20	0.40	0.60	0.008	0.016	0.024
HE	2.50	2.80	3.00	0.099	0.110	0.118

STYLE 1:

1. EMITTER
2. BASE
3. COLLECTOR

### SOLDERING FOOTPRINT\*

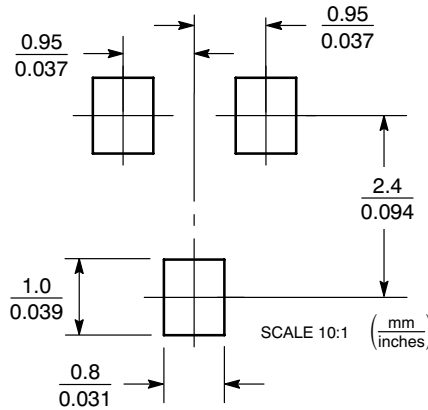

\*For additional information on our Pb-Free strategy and soldering details, please download the ON Semiconductor Soldering and Mounting Techniques Reference Manual, SOLDERRM/D.

ON Semiconductor and  are registered trademarks of Semiconductor Components Industries, LLC (SCILLC). SCILLC reserves the right to make changes without further notice to any products herein. SCILLC makes no warranty, representation or guarantee regarding the suitability of its products for any particular purpose, nor does SCILLC assume any liability arising out of the application or use of any product or circuit, and specifically disclaims any and all liability, including without limitation special, consequential or incidental damages. "Typical" parameters which may be provided in SCILLC data sheets and/or specifications can and do vary in different applications and actual performance may vary over time. All operating parameters, including "Typicals" must be validated for each customer application by customer's technical experts. SCILLC does not convey any license under its patent rights nor the rights of others. SCILLC products are not designed, intended, or authorized for use as components in systems intended for surgical implant into the body, or other applications intended to support or sustain life, or for any other application in which the failure of the SCILLC product could create a situation where personal injury or death may occur. Should Buyer purchase or use SCILLC products for any such unintended or unauthorized application, Buyer shall indemnify and hold SCILLC and its officers, employees, subsidiaries, affiliates, and distributors harmless against all claims, costs, damages, and expenses, and reasonable attorney fees arising out of, directly or indirectly, any claim of personal injury or death associated with such unintended or unauthorized use, even if such claim alleges that SCILLC was negligent regarding the design or manufacture of the part. SCILLC is an Equal Opportunity/Affirmative Action Employer. This literature is subject to all applicable copyright laws and is not for resale in any manner.

### PUBLICATION ORDERING INFORMATION

**LITERATURE FULFILLMENT:**  
Literature Distribution Center for ON Semiconductor  
P.O. Box 5163, Denver, Colorado 80217 USA  
**Phone:** 303-675-2175 or 800-344-3860 Toll Free USA/Canada  
**Fax:** 303-675-2176 or 800-344-3867 Toll Free USA/Canada  
**Email:** orderlit@onsemi.com

**N. American Technical Support:** 800-282-9855 Toll Free  
USA/Canada  
**Europe, Middle East and Africa Technical Support:**  
Phone: 421 33 790 2910  
**Japan Customer Focus Center**  
Phone: 81-3-5773-3850

**ON Semiconductor Website:** [www.onsemi.com](http://www.onsemi.com)

**Order Literature:** <http://www.onsemi.com/orderlit>

For additional information, please contact your local Sales Representative