

阅读申明

- 1.本站收集的数据手册和产品资料都来自互联网，版权归原作者所有。如读者和版权方有任何异议请及时告之，我们将妥善解决。
- 2.本站提供的中文数据手册是英文数据手册的中文翻译，其目的是协助用户阅读，该译文无法自动跟随原稿更新，同时也可能存在翻译上的不当。建议读者以英文原稿为参考以便获得更精准的信息。
- 3.本站提供的产品资料，来自厂商的技术支持或者使用者的心得体会等，其内容可能存在描述上的差异，建议读者做出适当判断。
- 4.如需与我们联系，请发邮件到marketing@iczoom.com，主题请标有“数据手册”字样。

Read Statement

1. The datasheets and other product information on the site are all from network reference or other public materials, and the copyright belongs to the original author and original published source. If readers and copyright owners have any objections, please contact us and we will deal with it in a timely manner.
2. The Chinese datasheets provided on the website is a Chinese translation of the English datasheets. Its purpose is for reader's learning exchange only and do not involve commercial purposes. The translation cannot be automatically updated with the original manuscript, and there may also be improper translations. Readers are advised to use the English manuscript as a reference for more accurate information.
3. All product information provided on the website refer to solutions from manufacturers' technical support or users the contents may have differences in description, and readers are advised to take the original article as the standard.
4. If you have any questions, please contact us at marketing@iczoom.com and mark the subject with "Datasheets" .

MUN5111T1 Series, SMUN5111T1, NSVMUN5111T1 Series

Bias Resistor Transistors

PNP Silicon Surface Mount Transistor with Monolithic Bias Resistor Network

This new series of digital transistors is designed to replace a single device and its external resistor bias network. The Bias Resistor Transistor (BRT) contains a single transistor with a monolithic bias network consisting of two resistors; a series base resistor and a base-emitter resistor. The BRT eliminates these individual components by integrating them into a single device. The use of a BRT can reduce both system cost and board space. The device is housed in the SC-70/SOT-323 package which is designed for low power surface mount applications.

Features

- Simplifies Circuit Design
- Reduces Board Space
- Reduces Component Count
- The SC-70/SOT-323 package can be soldered using wave or reflow. The modified gull-winged leads absorb thermal stress during soldering eliminating the possibility of damage to the die.
- Available in 8 mm embossed tape and reel – Use the Device Number to order the 7 inch/3000 unit reel. Replace “T1” with “T3” in the Device Number to order the 13 inch/10,000 unit reel.
- S and NSV Prefix for Automotive and Other Applications Requiring Unique Site and Control Change Requirements; AEC-Q101 Qualified and PPAP Capable
- These Devices are Pb-Free, Halogen Free/BFR Free and are RoHS Compliant*

MAXIMUM RATINGS ($T_A = 25^\circ\text{C}$ unless otherwise noted)

Rating	Symbol	Value	Unit
Collector-Base Voltage	V_{CBO}	50	Vdc
Collector-Emitter Voltage	V_{CEO}	50	Vdc
Collector Current	I_C	100	mAdc

Stresses exceeding Maximum Ratings may damage the device. Maximum Ratings are stress ratings only. Functional operation above the Recommended Operating Conditions is not implied. Extended exposure to stresses above the Recommended Operating Conditions may affect device reliability.

*For additional information on our Pb-Free strategy and soldering details, please download the ON Semiconductor Soldering and Mounting Techniques Reference Manual, SOLDERRM/D.



ON Semiconductor®

<http://onsemi.com>

PNP SILICON BIAS RESISTOR TRANSISTORS

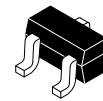

SC-70/SOT-323
CASE 419
STYLE 3

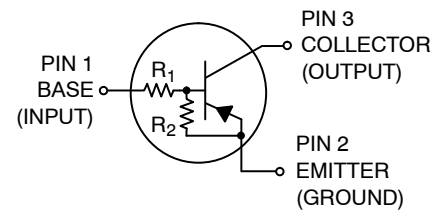

MARKING DIAGRAM

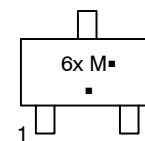

- 6x = Device Code
- M = Date Code*
- = Pb-Free Package

(Note: Microdot may be in either location)
*Date Code orientation may vary depending upon manufacturing location.

ORDERING INFORMATION

See specific ordering and shipping information in the package dimensions section on page 2 of this data sheet.

MUN5111T1 Series, SMUN5111T1, NSVMUN5111T1 Series

THERMAL CHARACTERISTICS

Characteristic	Symbol	Max	Unit
Total Device Dissipation $T_A = 25^\circ\text{C}$ Derate above 25°C	P_D	202 (Note 1) 310 (Note 2) 1.6 (Note 1) 2.5 (Note 2)	mW $^\circ\text{C/W}$
Thermal Resistance, Junction-to-Ambient	$R_{\theta JA}$	618 (Note 1) 403 (Note 2)	$^\circ\text{C/W}$
Thermal Resistance, Junction-to-Lead	$R_{\theta JL}$	280 (Note 1) 332 (Note 2)	$^\circ\text{C/W}$
Junction and Storage Temperature Range	T_J, T_{stg}	-55 to +150	$^\circ\text{C}$

- FR-4 @ Minimum Pad
- FR-4 @ 1.0 x 1.0 inch Pad

ORDERING INFORMATION AND RESISTOR VALUES

Device	Package	Marking	R1 (K)	R2 (K)	Shipping†
MUN5111T1G, SMUN5111T1G	SC-70/SOT-323 (Pb-Free)	6A	10	10	3,000/Tape & Reel
MUN5112T1G, SMUN5112T1G	SC-70/SOT-323 (Pb-Free)	6B	22	22	3,000/Tape & Reel
MUN5113T1G, SMUN5113T1G	SC-70/SOT-323 (Pb-Free)	6C	47	47	3,000/Tape & Reel
MUN5113T3G	SC-70/SOT-323 (Pb-Free)	6C	47	47	10,000/Tape & Reel
MUN5113T1G	SC-70/SOT-323 (Pb-Free)	6C	47	47	3,000/Tape & Reel
MUN5114T1G, SMUN5114T1G	SC-70/SOT-323 (Pb-Free)	6D	10	47	3,000/Tape & Reel
MUN5115T1G (Note 3)	SC-70/SOT-323 (Pb-Free)	6E	10	∞	3,000/Tape & Reel
MUN5116T1G (Note 3)	SC-70/SOT-323 (Pb-Free)	6F	4.7	∞	3,000/Tape & Reel
MUN5130T1G (Note 3)	SC-70/SOT-323 (Pb-Free)	6G	1.0	1.0	3,000/Tape & Reel
MUN5131T1G (Note 3)	SC-70/SOT-323 (Pb-Free)	6H	2.2	2.2	3,000/Tape & Reel
MUN5132T1G, NSVMUN5132T1G (Note 3)	SC-70/SOT-323 (Pb-Free)	6J	4.7	4.7	3,000/Tape & Reel
MUN5133T1G, SMUN5133T1G (Note 3)	SC-70/SOT-323 (Pb-Free)	6K	4.7	47	3,000/Tape & Reel
MUN5134T1G (Note 3)	SC-70/SOT-323 (Pb-Free)	6L	22	47	3,000/Tape & Reel
MUN5135T1G (Note 3)	SC-70/SOT-323 (Pb-Free)	6M	2.2	47	3,000/Tape & Reel
MUN5136T1G	SC-70/SOT-323 (Pb-Free)	6N	100	100	3,000/Tape & Reel
MUN5137T1G	SC-70/SOT-323 (Pb-Free)	6P	47	22	3,000/Tape & Reel

†For information on tape and reel specifications, including part orientation and tape sizes, please refer to our Tape and Reel Packaging Specifications Brochure, BRD8011/D.

- New devices. Updated curves to follow in subsequent data sheets.

MUN5111T1 Series, SMUN5111T1, NSVMUN5111T1 Series

ELECTRICAL CHARACTERISTICS (T_A = 25°C unless otherwise noted)

Characteristic	Symbol	Min	Typ	Max	Unit
OFF CHARACTERISTICS					
Collector-Base Cutoff Current (V _{CB} = 50 V, I _E = 0)	I _{CBO}	-	-	100	nAdc
Collector-Emitter Cutoff Current (V _{CE} = 50 V, I _B = 0)	I _{CEO}	-	-	500	nAdc
Emitter-Base Cutoff Current (V _{EB} = 6.0 V, I _C = 0)	I _{EBO}				mAdc
MUN5111T1, SMUN5111T1		-	-	0.5	
MUN5112T1, SMUN5112T1		-	-	0.2	
MUN5113T1, SMUN5113T1		-	-	0.1	
MUN5114T1, SMUN5114T1		-	-	0.2	
MUN5115T1		-	-	0.9	
MUN5116T1		-	-	1.9	
MUN5130T1		-	-	4.3	
MUN5131T1		-	-	2.3	
MUN5132T1, NSVMUN5132T1		-	-	1.5	
MUN5133T1, SMUN5133T1		-	-	0.18	
MUN5134T1		-	-	0.13	
MUN5135T1		-	-	0.2	
MUN5136T1		-	-	0.05	
MUN5137T1		-	-	0.13	
Collector-Base Breakdown Voltage (I _C = 10 μA, I _E = 0)	V _{(BR)CBO}	50	-	-	Vdc
Collector-Emitter Breakdown Voltage (Note 4) (I _C = 2.0 mA, I _B = 0)	V _{(BR)CEO}	50	-	-	Vdc

ON CHARACTERISTICS (Note 4)

DC Current Gain (V _{CE} = 10 V, I _C = 5.0 mA)	h _{FE}				
MUN5111T1, SMUN5111T1		35	60	-	
MUN5112T1, SMUN5112T1		60	100	-	
MUN5113T1, SMUN5113T1		80	140	-	
MUN5114T1, SMUN5114T1		80	140	-	
MUN5115T1		160	250	-	
MUN5116T1		160	250	-	
MUN5130T1		3.0	5.0	-	
MUN5131T1		8.0	15	-	
MUN5132T1, NSVMUN5132T1		15	27	-	
MUN5133T1, SMUN5133T1		80	140	-	
MUN5134T1		80	130	-	
MUN5135T1		80	140	-	
MUN5136T1		80	150	-	
MUN5137T1		80	140	-	
Collector-Emitter Saturation Voltage (I _C = 10 mA, I _E = 0.3 mA)	V _{CE(sat)}				Vdc
MUN5130T1/MUN5131T1		-	-	0.25	
(I _C = 10 mA, I _B = 5 mA)					
(I _C = 10 mA, I _B = 1 mA)					
MUN5115T1/MUN5116T1/MUN5132T1/NSVMUN5132T1/ MUN5133T1/SMUN5133T1/MUN5134T1		-	-	0.25	
Output Voltage (on) (V _{CC} = 5.0 V, V _B = 2.5 V, R _L = 1.0 kΩ)	V _{OL}				Vdc
MUN5111T1, SMUN5111T1		-	-	0.2	
MUN5112T1, SMUN5112T1		-	-	0.2	
MUN5114T1, SMUN5114T1		-	-	0.2	
MUN5115T1		-	-	0.2	
MUN5116T1		-	-	0.2	
MUN5130T1		-	-	0.2	
MUN5131T1		-	-	0.2	
MUN5132T1, NSVMUN5132T1		-	-	0.2	
MUN5133T1, SMUN5133T1		-	-	0.2	
MUN5134T1		-	-	0.2	
MUN5135T1		-	-	0.2	
(V _{CC} = 5.0 V, V _B = 3.5 V, R _L = 1.0 kΩ)					
MUN5113T1		-	-	0.2	
(V _{CC} = 5.0 V, V _B = 5.5 V, R _L = 1.0 kΩ)					
MUN5136T1		-	-	0.2	
(V _{CC} = 5.0 V, V _B = 4.0 V, R _L = 1.0 kΩ)					
MUN5137T1		-	-	0.2	

4. Pulse Test: Pulse Width < 300 μs, Duty Cycle < 2.0%

MUN5111T1 Series, SMUN5111T1, NSVMUN5111T1 Series

ELECTRICAL CHARACTERISTICS ($T_A = 25^\circ\text{C}$ unless otherwise noted) (Continued)

Characteristic	Symbol	Min	Typ	Max	Unit
Output Voltage (off) ($V_{CC} = 5.0\text{ V}$, $V_B = 0.5\text{ V}$, $R_L = 1.0\text{ k}\Omega$) ($V_{CC} = 5.0\text{ V}$, $V_B = 0.050\text{ V}$, $R_L = 1.0\text{ k}\Omega$) MUN5130T1 ($V_{CC} = 5.0\text{ V}$, $V_B = 0.25\text{ V}$, $R_L = 1.0\text{ k}\Omega$) MUN5115T1 MUN5116T1 MUN5131T1 MUN5132T1, NSVMUN5132T1	V_{OH}	4.9 4.9 4.9 4.9 4.9	- - - - -	- - - - -	Vdc
Input Resistor MUN5111T1, SMUN5111T1 MUN5112T1, SMUN5112T1 MUN5113T1, SMUN5113T1 MUN5114T1, SMUN5114T1 MUN5115T1 MUN5116T1 MUN5130T1 MUN5131T1 MUN5132T1, NSVMUN5132T1 MUN5133T1, SMUN5133T1 MUN5134T1 MUN5135T1 MUN5136T1 MUN5137T1	R_1	7.0 15.4 32.9 7.0 7.0 3.3 0.7 1.5 3.3 3.3 15.4 1.54 70 32.9	10 22 47 10 10 4.7 1.0 2.2 4.7 4.7 22 2.2 100 47	13 28.6 61.1 13 13 6.1 1.3 2.9 6.1 6.1 28.6 2.86 130 61.1	k Ω
Resistor Ratio MUN5111T1/SMUN5111T1/MUN5112T1/SMUN5112T1/ MUN5113T1/SMUN5113T1/MUN5136T1 MUN5114T1/SMUN5114T1 MUN5115T1/MUN5116T1 MUN5130T1/MUN5131T1/MUN5132T1/NSVMUN5132T1 MUN5133T1/SMUN5133T1 MUN5134T1 MUN5135T1 MUN5136T1 MUN5137T1	R_1/R_2	0.8 0.17 - 0.8 0.055 0.38 0.038 1.7	1.0 0.21 - 1.0 0.1 0.47 0.047 2.1	1.2 0.25 - 1.2 0.185 0.56 0.056 2.6	

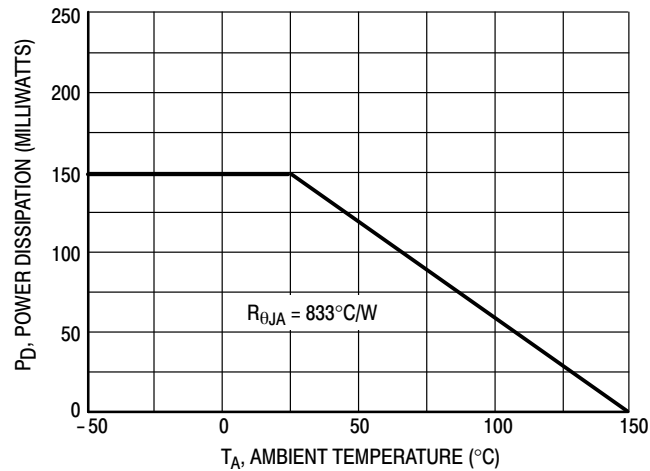

Figure 1. Derating Curve

MUN5111T1 Series, SMUN5111T1, NSVMUN5111T1 Series

TYPICAL ELECTRICAL CHARACTERISTICS – MUN5111T1G, SMUN5111T1G

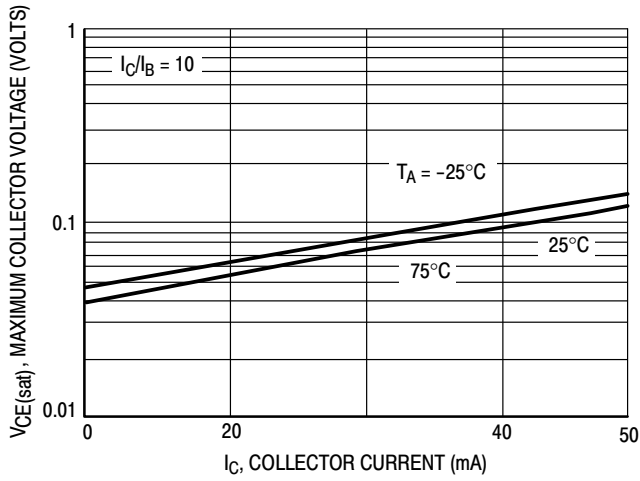

Figure 2. $V_{CE(sat)}$ versus I_C

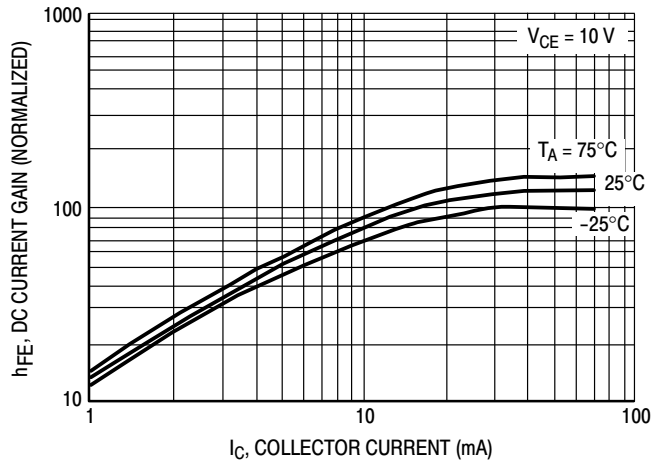

Figure 3. DC Current Gain

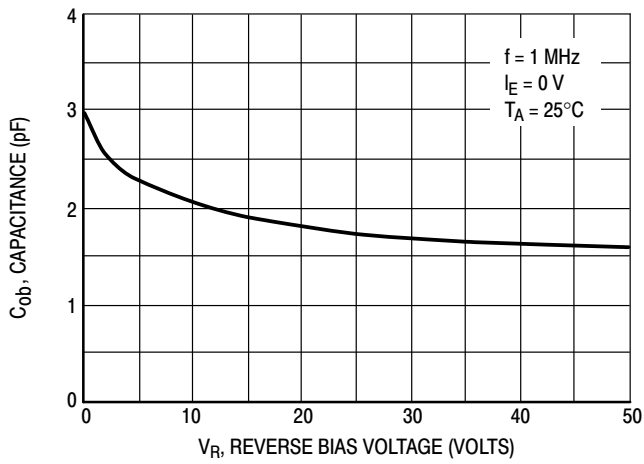

Figure 4. Output Capacitance

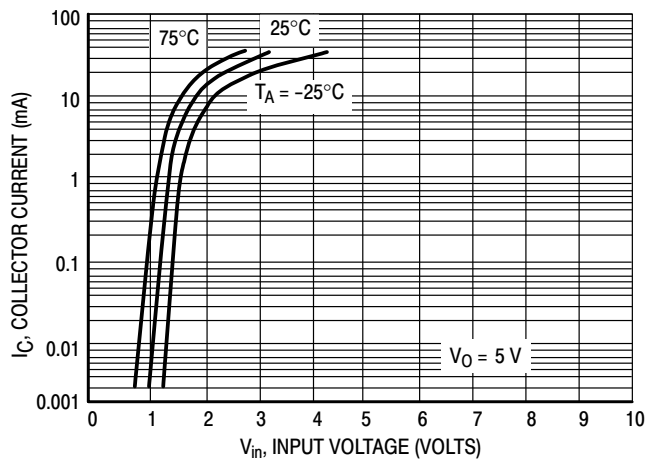

Figure 5. Output Current versus Input Voltage

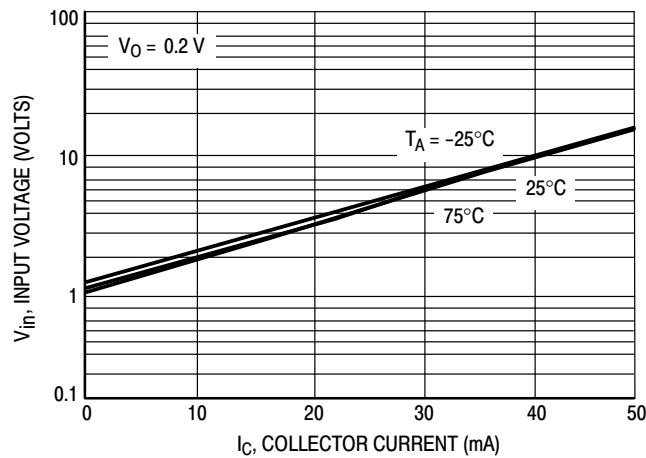

Figure 6. Input Voltage versus Output Current

MUN5111T1 Series, SMUN5111T1, NSVMUN5111T1 Series

TYPICAL ELECTRICAL CHARACTERISTICS – MUN5112T1G, SMUN5112T1G

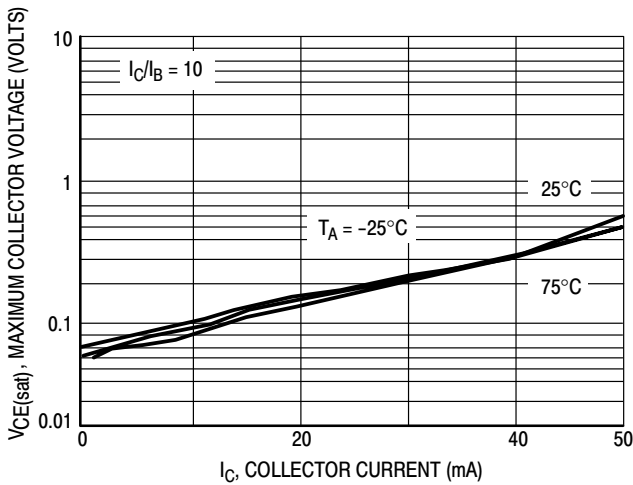

Figure 7. $V_{CE(sat)}$ versus I_C

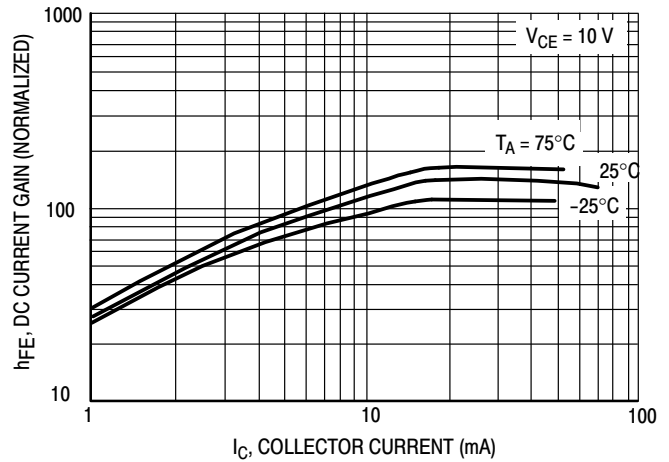

Figure 8. DC Current Gain

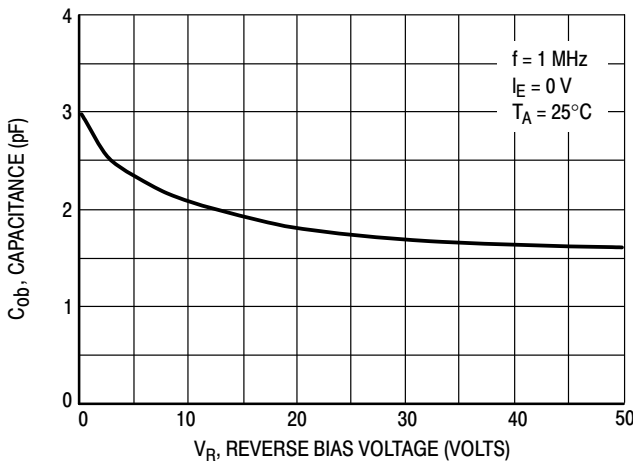

Figure 9. Output Capacitance

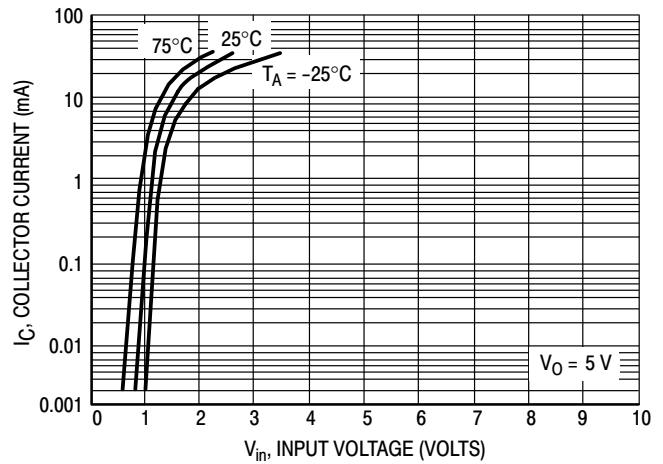

Figure 10. Output Current versus Input Voltage

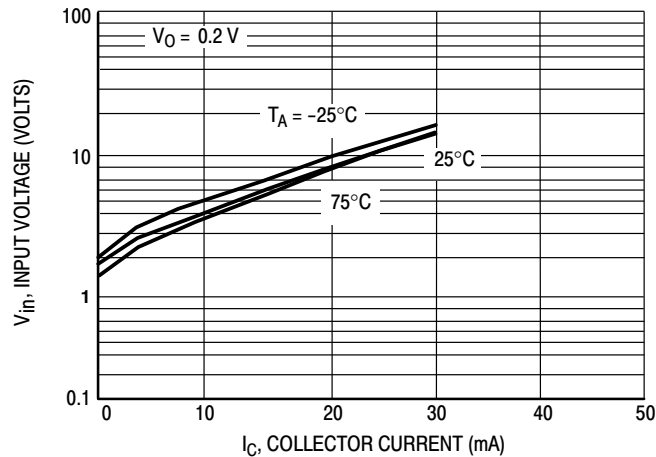

Figure 11. Input Voltage versus Output Current

MUN5111T1 Series, SMUN5111T1, NSVMUN5111T1 Series

TYPICAL ELECTRICAL CHARACTERISTICS – MUN5113T1G, SMUN5113T1G

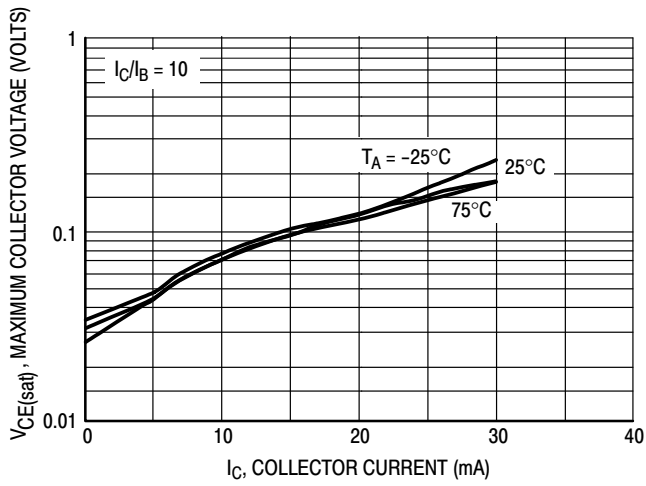

Figure 12. $V_{CE(sat)}$ versus I_C

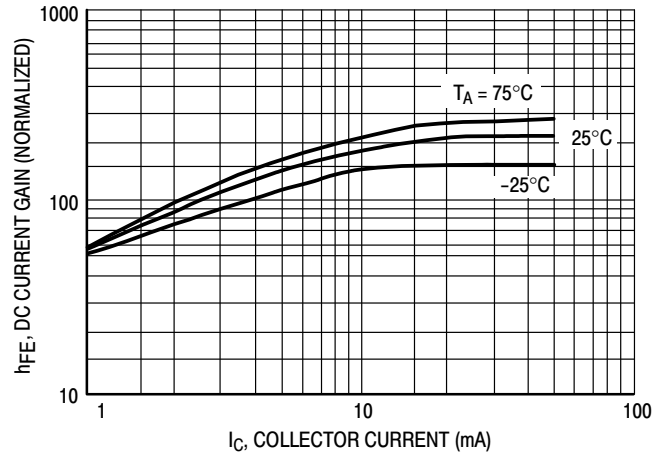

Figure 13. DC Current Gain

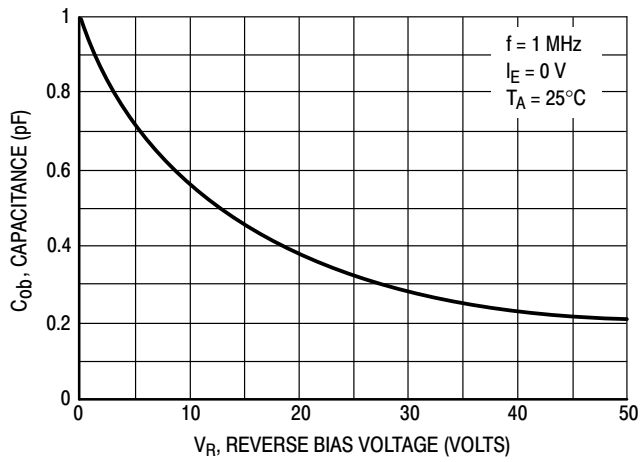

Figure 14. Output Capacitance

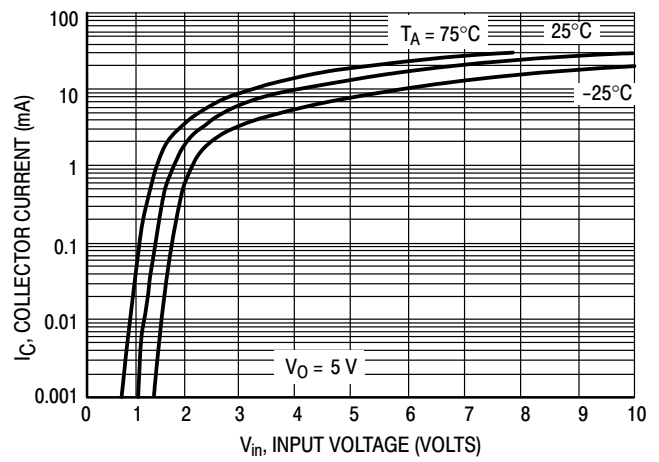

Figure 15. Output Current versus Input Voltage

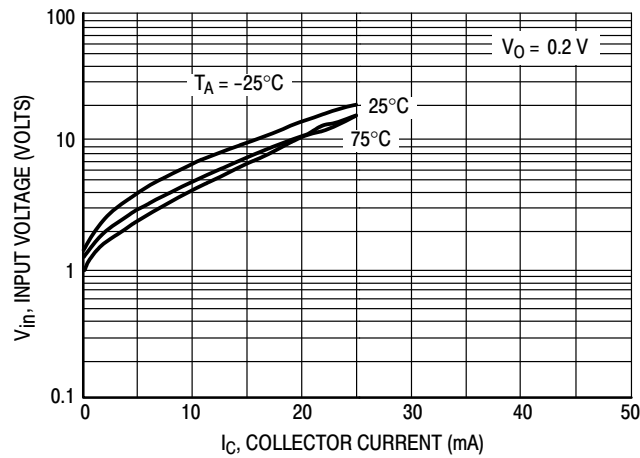

Figure 16. Input Voltage versus Output Current

MUN5111T1 Series, SMUN5111T1, NSVMUN5111T1 Series

TYPICAL ELECTRICAL CHARACTERISTICS – MUN5114T1G, SMUN5114T1G

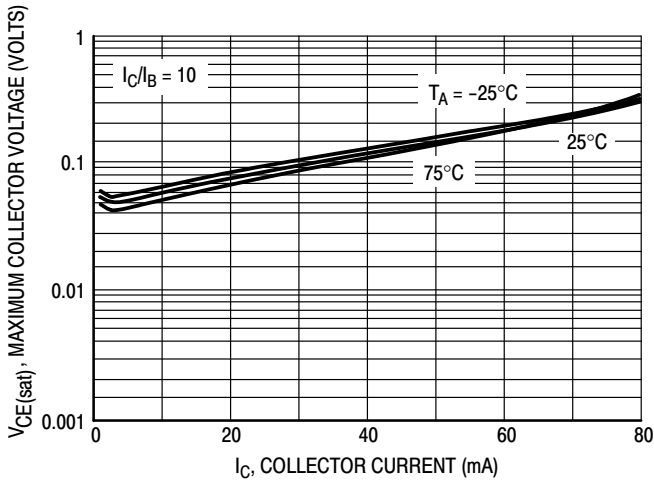

Figure 17. $V_{CE(sat)}$ versus I_C

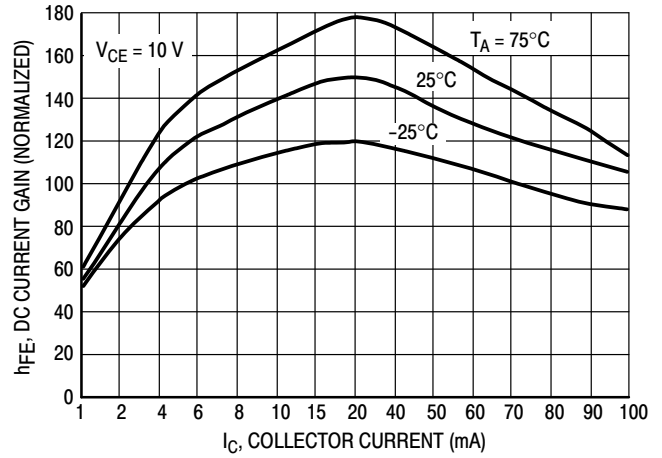

Figure 18. DC Current Gain

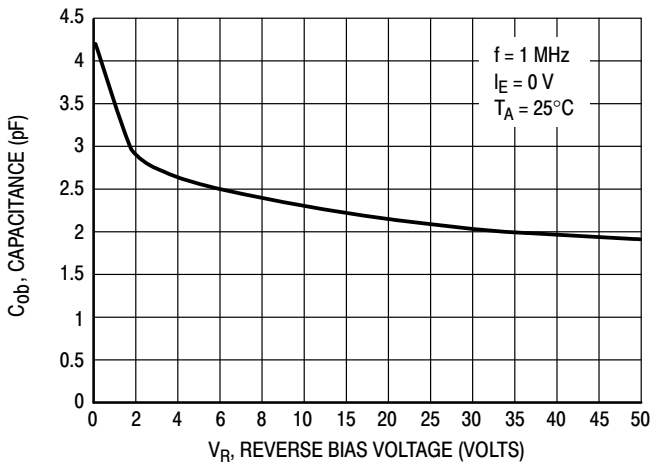

Figure 19. Output Capacitance

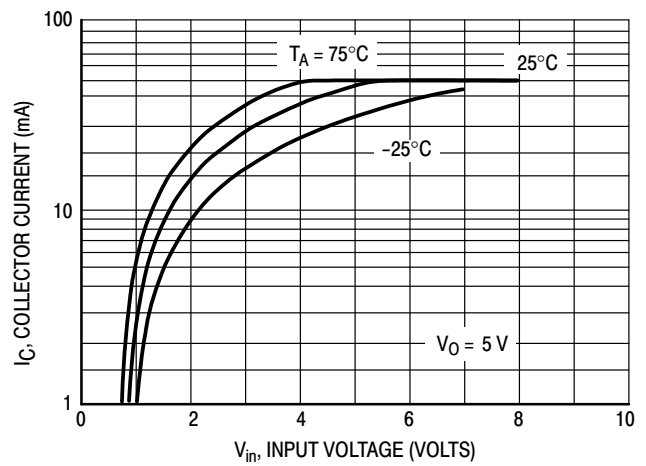

Figure 20. Output Current versus Input Voltage

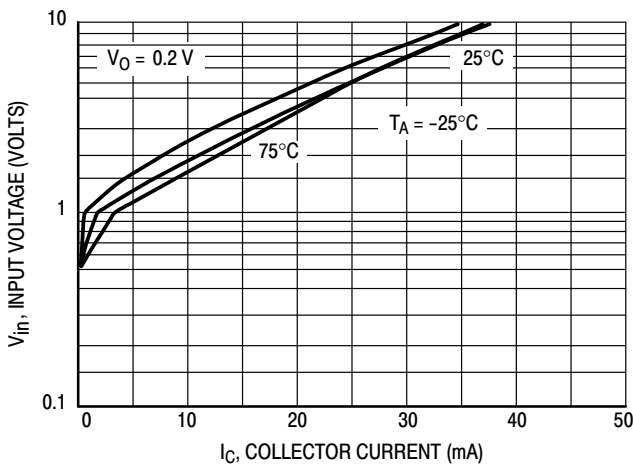

Figure 21. Input Voltage versus Output Current

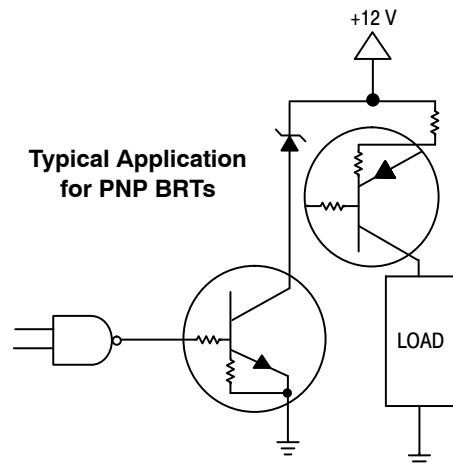

Figure 22. Inexpensive, Unregulated Current Source

MUN5111T1 Series, SMUN5111T1, NSVMUN5111T1 Series

TYPICAL ELECTRICAL CHARACTERISTICS — MUN5132T1G, NSVMUN5132T1G

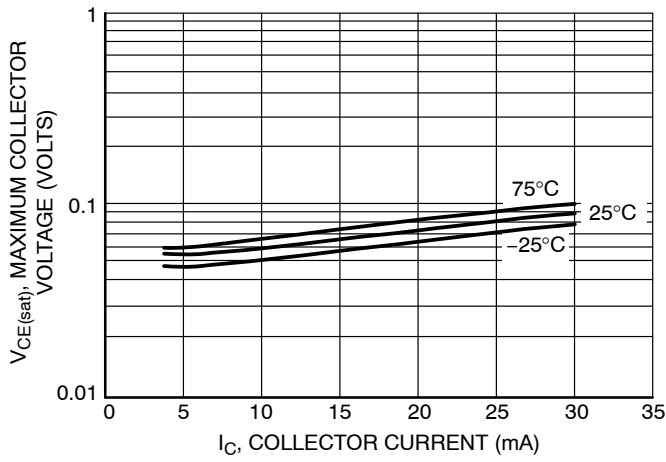

Figure 23. Maximum Collector Voltage versus Collector Current

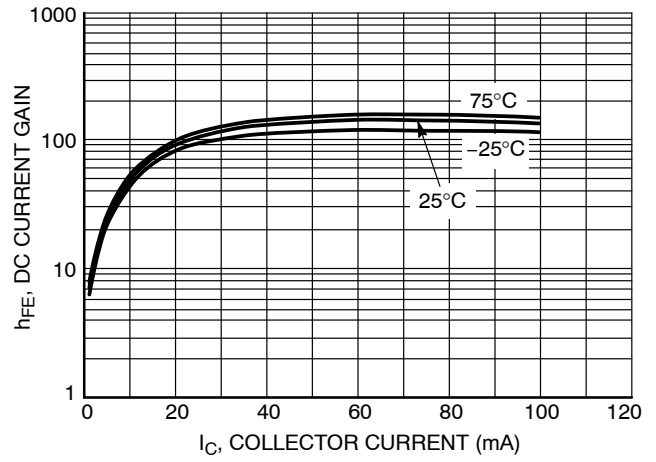

Figure 24. DC Current Gain

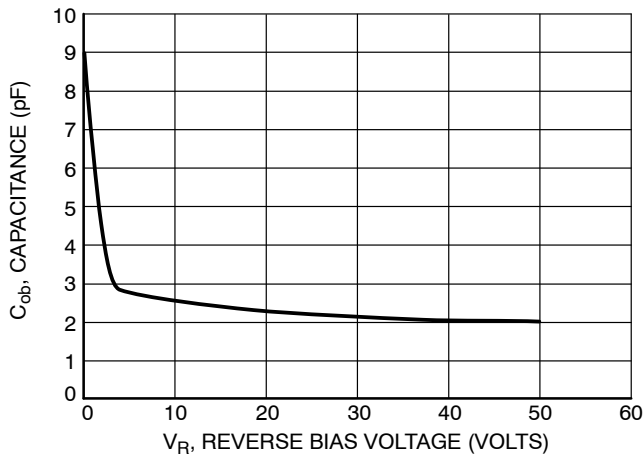

Figure 25. Output Capacitance

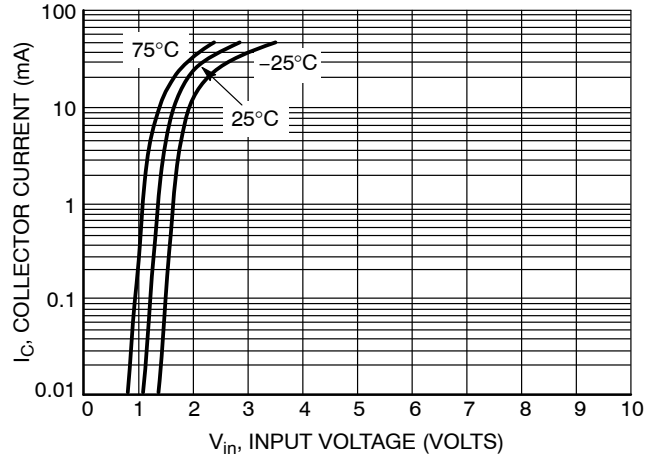

Figure 26. Output Current versus Input Voltage

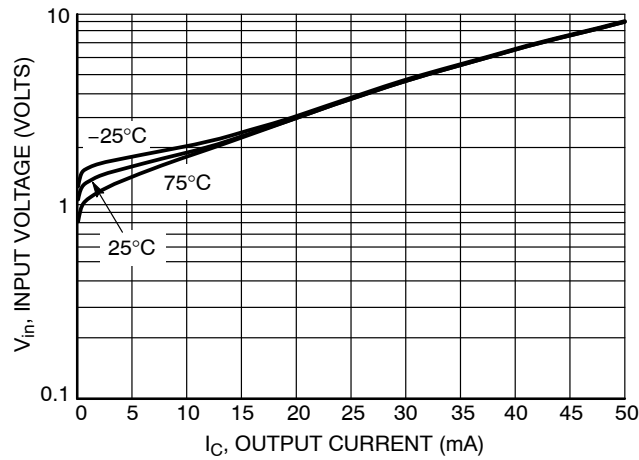

Figure 27. Input Voltage versus Output Current

MUN5111T1 Series, SMUN5111T1, NSVMUN5111T1 Series

TYPICAL ELECTRICAL CHARACTERISTICS — MUN5133T1G, SMUN5133T1G

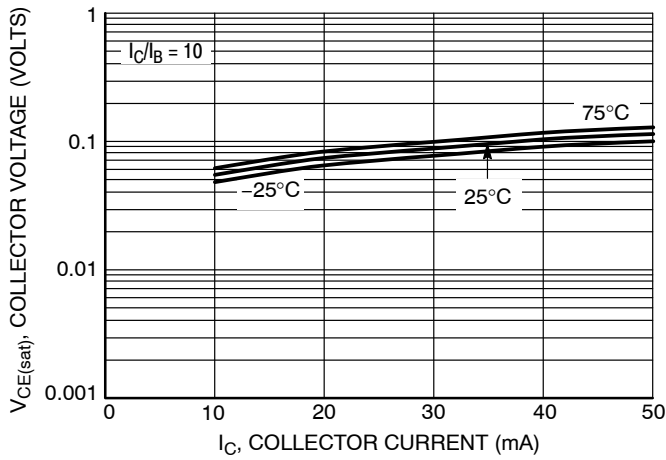

Figure 28. $V_{CE(sat)}$ versus I_C

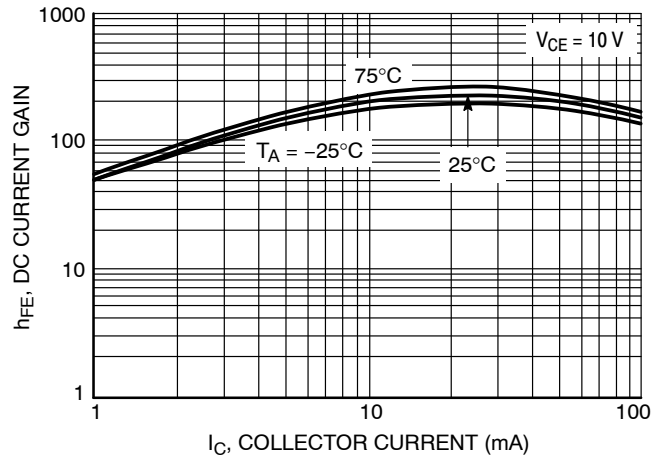

Figure 29. DC Current Gain

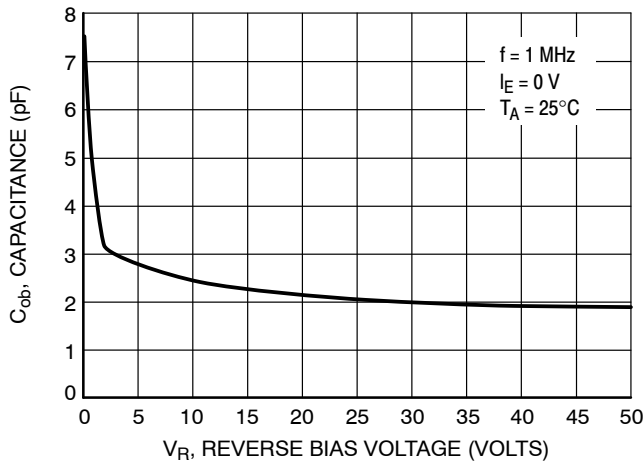

Figure 30. Output Capacitance

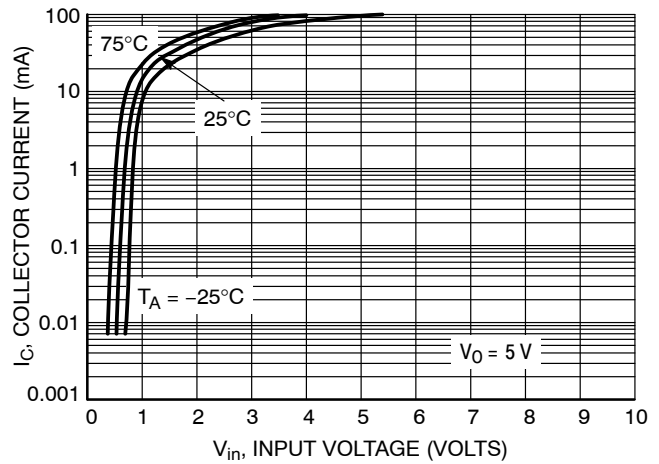

Figure 31. Output Current versus Input Voltage

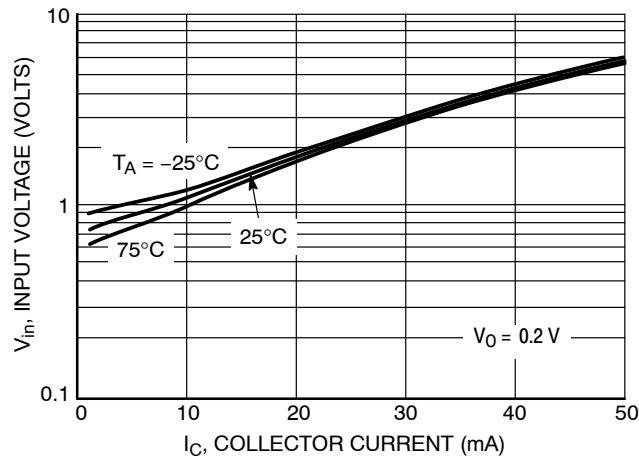

Figure 32. Input Voltage versus Output Current

TYPICAL ELECTRICAL CHARACTERISTICS — MUN5135T1G

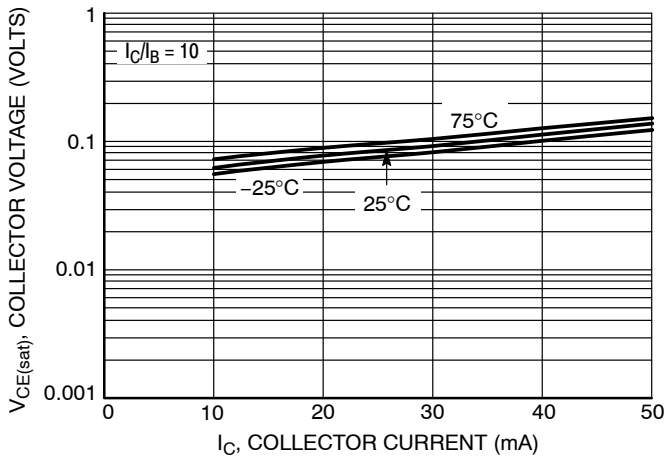

Figure 33. $V_{CE(sat)}$ versus I_C

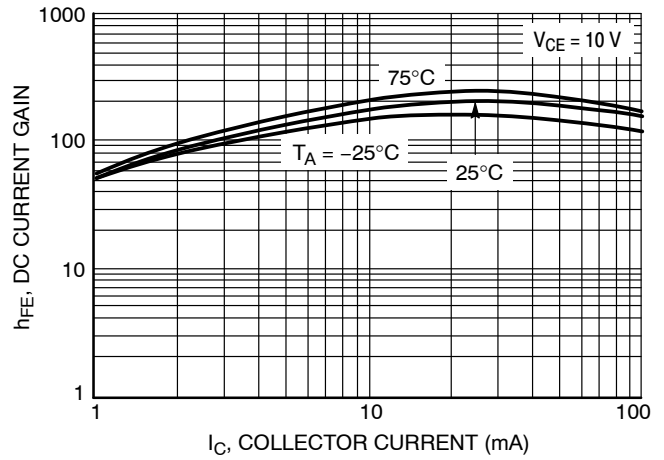

Figure 34. DC Current Gain

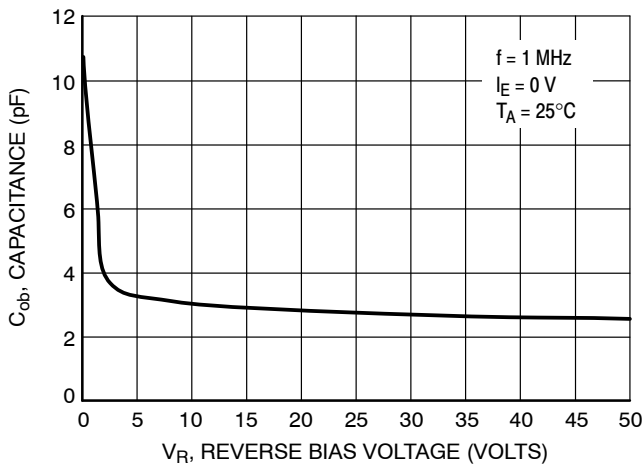

Figure 35. Output Capacitance

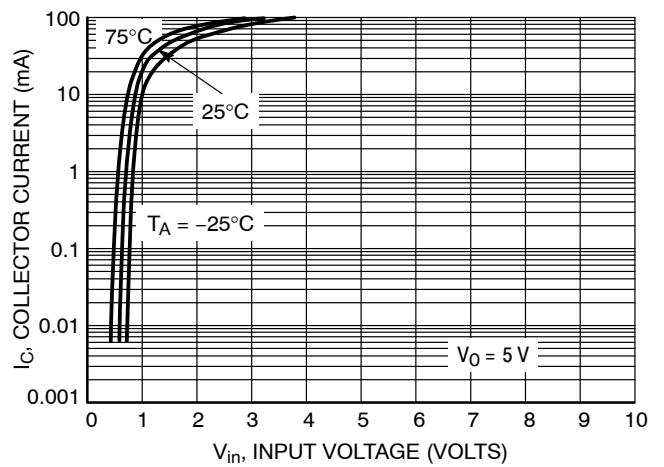

Figure 36. Output Current versus Input Voltage

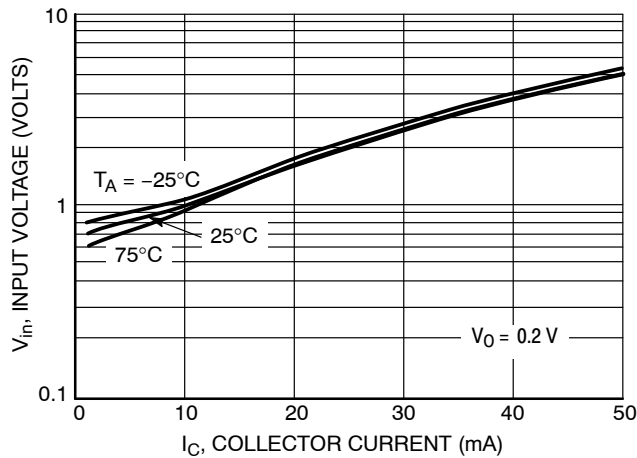

Figure 37. Input Voltage versus Output Current

TYPICAL ELECTRICAL CHARACTERISTICS — MUN5136T1G

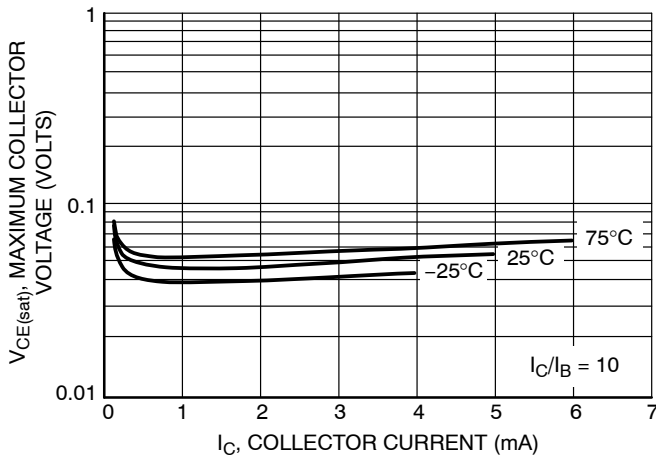

Figure 38. Maximum Collector Voltage versus Collector Current

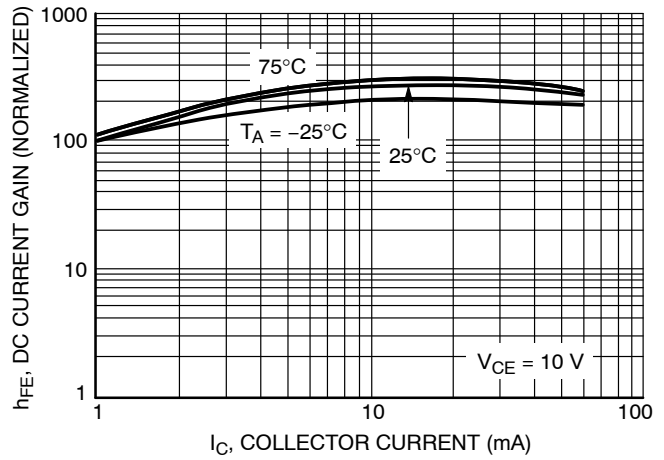

Figure 39. DC Current Gain

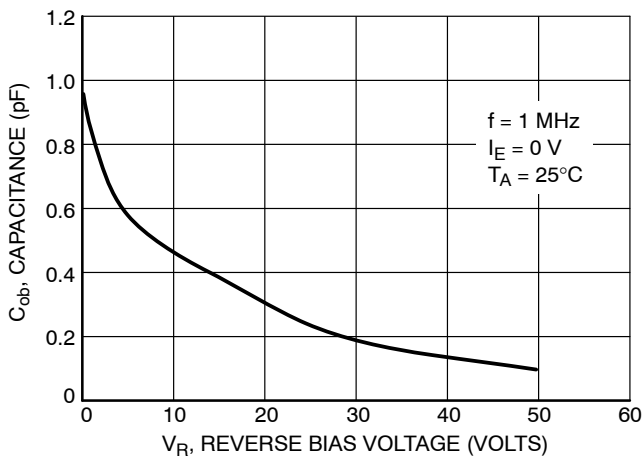

Figure 40. Output Capacitance

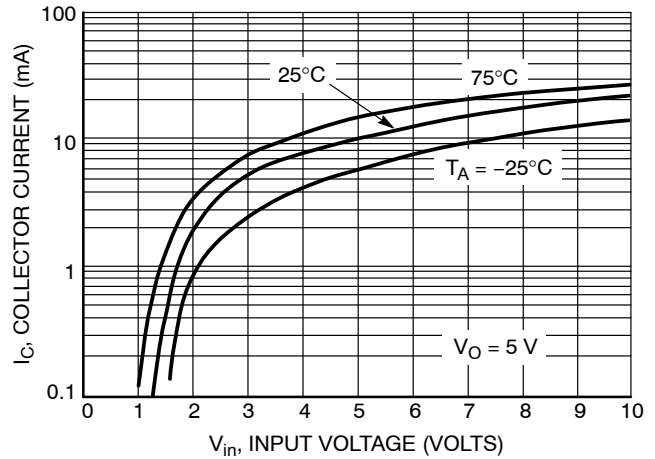

Figure 41. Output Current versus Input Voltage

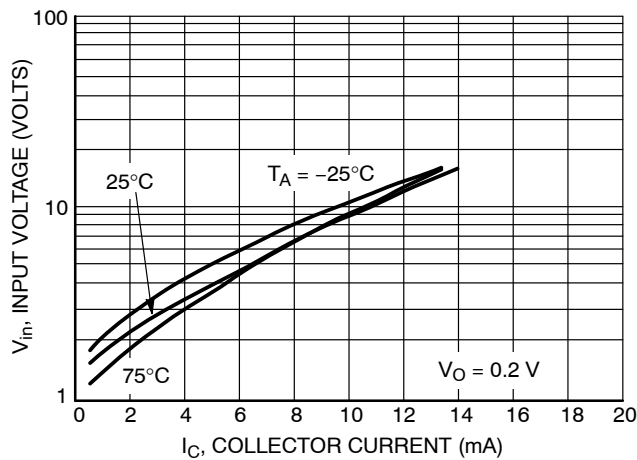

Figure 42. Input Voltage versus Output Current

TYPICAL ELECTRICAL CHARACTERISTICS — MUN5137T1G

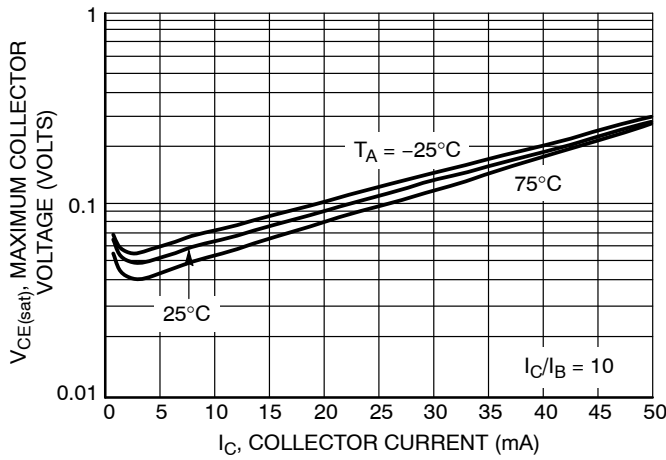

Figure 43. Maximum Collector Voltage versus Collector Current

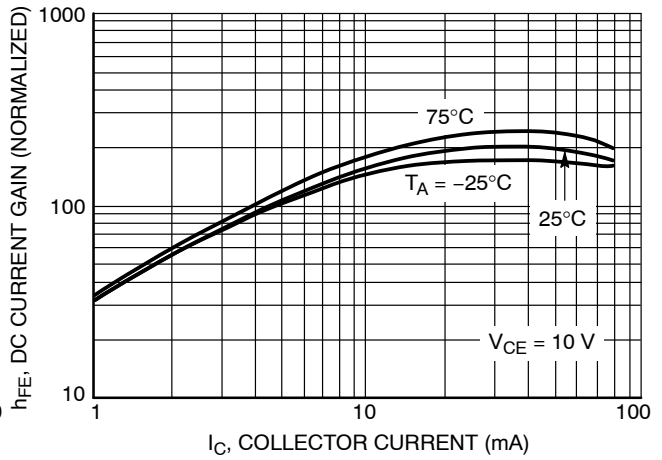

Figure 44. DC Current Gain

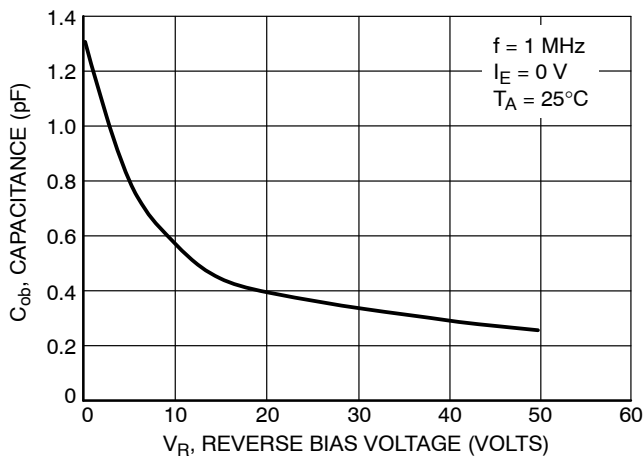

Figure 45. Output Capacitance

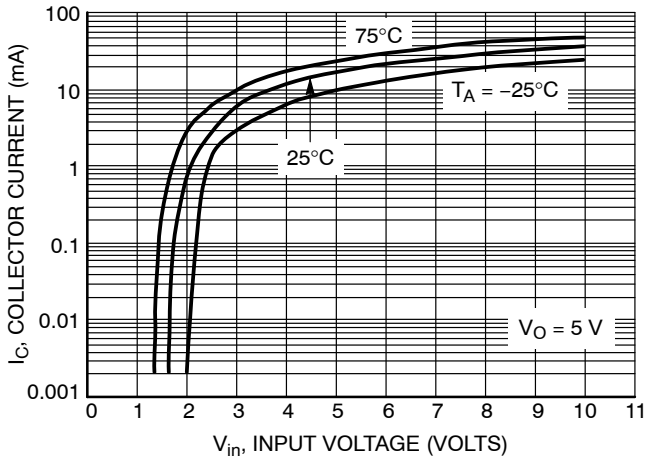

Figure 46. Output Current versus Input Voltage

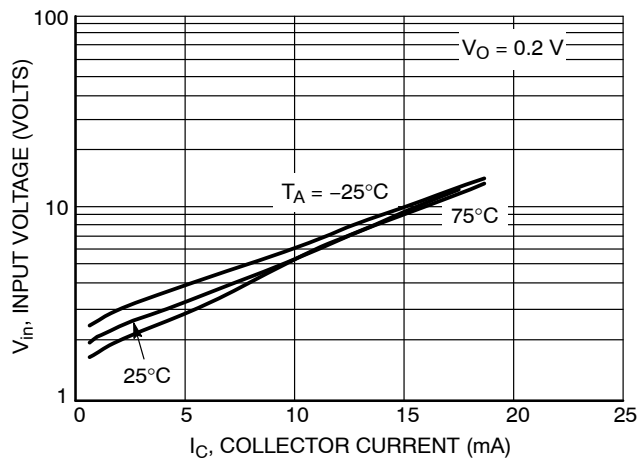
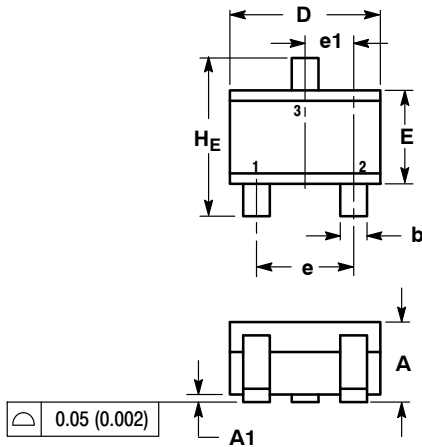

Figure 47. Input Voltage versus Output Current

MUN5111T1 Series, SMUN5111T1, NSVMUN5111T1 Series

PACKAGE DIMENSIONS

SC-70/SOT-323
CASE 419-04
ISSUE N



- NOTES:
1. DIMENSIONING AND TOLERANCING PER ANSI Y14.5M, 1982.
2. CONTROLLING DIMENSION: INCH.

DIM	MILLIMETERS			INCHES		
	MIN	NOM	MAX	MIN	NOM	MAX
A	0.80	0.90	1.00	0.032	0.035	0.040
A1	0.00	0.05	0.10	0.000	0.002	0.004
A2	0.70 REF			0.028 REF		
b	0.30	0.35	0.40	0.012	0.014	0.016
c	0.10	0.18	0.25	0.004	0.007	0.010
D	1.80	2.10	2.20	0.071	0.083	0.087
E	1.15	1.24	1.35	0.045	0.049	0.053
e	1.20	1.30	1.40	0.047	0.051	0.055
e1	0.65 BSC			0.026 BSC		
L	0.20	0.38	0.56	0.008	0.015	0.022
HE	2.00	2.10	2.40	0.079	0.083	0.095

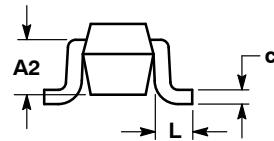

STYLE 3:
PIN 1. BASE
2. EMITTER
3. COLLECTOR

SOLDERING FOOTPRINT*

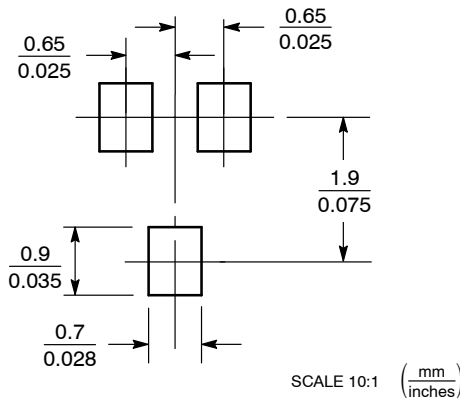

*For additional information on our Pb-Free strategy and soldering details, please download the ON Semiconductor Soldering and Mounting Techniques Reference Manual, SOLDERRM/D.

ON Semiconductor and are registered trademarks of Semiconductor Components Industries, LLC (SCILLC). SCILLC reserves the right to make changes without further notice to any products herein. SCILLC makes no warranty, representation or guarantee regarding the suitability of its products for any particular purpose, nor does SCILLC assume any liability arising out of the application or use of any product or circuit, and specifically disclaims any and all liability, including without limitation special, consequential or incidental damages. "Typical" parameters which may be provided in SCILLC data sheets and/or specifications can and do vary in different applications and actual performance may vary over time. All operating parameters, including "Typicals" must be validated for each customer application by customer's technical experts. SCILLC does not convey any license under its patent rights nor the rights of others. SCILLC products are not designed, intended, or authorized for use as components in systems intended for surgical implant into the body, or other applications intended to support or sustain life, or for any other application in which the failure of the SCILLC product could create a situation where personal injury or death may occur. Should Buyer purchase or use SCILLC products for any such unintended or unauthorized application, Buyer shall indemnify and hold SCILLC and its officers, employees, subsidiaries, affiliates, and distributors harmless against all claims, costs, damages, and expenses, and reasonable attorney fees arising out of, directly or indirectly, any claim of personal injury or death associated with such unintended or unauthorized use, even if such claim alleges that SCILLC was negligent regarding the design or manufacture of the part. SCILLC is an Equal Opportunity/Affirmative Action Employer. This literature is subject to all applicable copyright laws and is not for resale in any manner.

PUBLICATION ORDERING INFORMATION

LITERATURE FULFILLMENT:
Literature Distribution Center for ON Semiconductor
P.O. Box 5163, Denver, Colorado 80217 USA
Phone: 303-675-2175 or 800-344-3860 Toll Free USA/Canada
Fax: 303-675-2176 or 800-344-3867 Toll Free USA/Canada
Email: orderlit@onsemi.com

N. American Technical Support: 800-282-9855 Toll Free
USA/Canada
Europe, Middle East and Africa Technical Support:
Phone: 421 33 790 2910
Japan Customer Focus Center
Phone: 81-3-5817-1050

ON Semiconductor Website: www.onsemi.com
Order Literature: <http://www.onsemi.com/orderlit>
For additional information, please contact your local Sales Representative