

## 阅读申明

- 1.本站收集的数据手册和产品资料都来自互联网，版权归原作者所有。如读者和版权方有任何异议请及时告之，我们将妥善解决。
- 2.本站提供的中文数据手册是英文数据手册的中文翻译，其目的是协助用户阅读，该译文无法自动跟随原稿更新，同时也可能存在翻译上的不当。建议读者以英文原稿为参考以便获得更精准的信息。
- 3.本站提供的产品资料，来自厂商的技术支持或者使用者的心得体会等，其内容可能存在描述上的差异，建议读者做出适当判断。
- 4.如需与我们联系，请发邮件到marketing@iczoom.com，主题请标有“数据手册”字样。

## Read Statement

1. The datasheets and other product information on the site are all from network reference or other public materials, and the copyright belongs to the original author and original published source. If readers and copyright owners have any objections, please contact us and we will deal with it in a timely manner.
2. The Chinese datasheets provided on the website is a Chinese translation of the English datasheets. Its purpose is for reader's learning exchange only and do not involve commercial purposes. The translation cannot be automatically updated with the original manuscript, and there may also be improper translations. Readers are advised to use the English manuscript as a reference for more accurate information.
3. All product information provided on the website refer to solutions from manufacturers' technical support or users the contents may have differences in description, and readers are advised to take the original article as the standard.
4. If you have any questions, please contact us at marketing@iczoom.com and mark the subject with "Datasheets" .

## Transient protected AC power switch

### Features

- Triac with overvoltage crowbar technology
- Low  $I_{GT}$  (<10 mA) or high immunity ( $I_{GT}$ <35 mA) version
- High noise immunity: static  $dV/dt > 2000$  V/ $\mu$ s

### Benefits

- Enables equipment to meet IEC 61000-4-5
- High off-state reliability with planar technology
- Need no external over voltage protection
- Reduces the power passive component count
- High immunity against fast transients described in IEC 61000-4-4 standards

### Applications

- AC mains static switching in appliance and industrial control systems
- Drive of medium power AC loads like:
  - Universal drum motor of washing machine
  - Compressor for fridge or air conditioner

### Description

The **ACST12 series** belongs to the ACS/ACST family built with the ASD (application specific discrete) technology. This high performance device is adapted to home appliances or industrial systems and drives loads up to 12 A.

This ACST12 switch embeds a TRIAC structure and a high voltage clamping device able to absorb the inductive turn-off energy and withstand line transients such as those described in the IEC 61000-4-5 standards. The ACST12-7S needs a low gate current to be activated ( $I_{GT} < 10$  mA) and in the mean time provides a high electrical noise immunity such as those described in the IEC 61000-4-4 standards. The ACST12-7C offers an extremely high static  $dV/dt$  immunity of 2 kV/ $\mu$ s minimum.

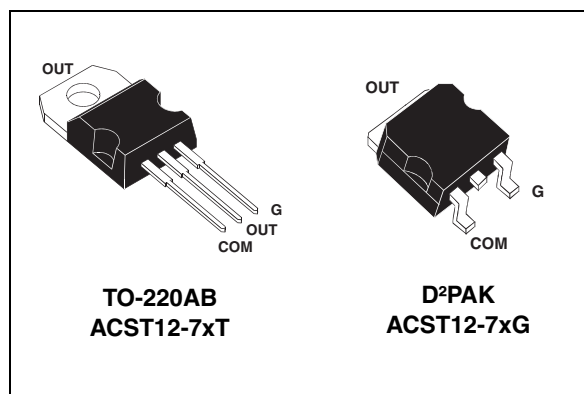

Figure 1. Functional diagram

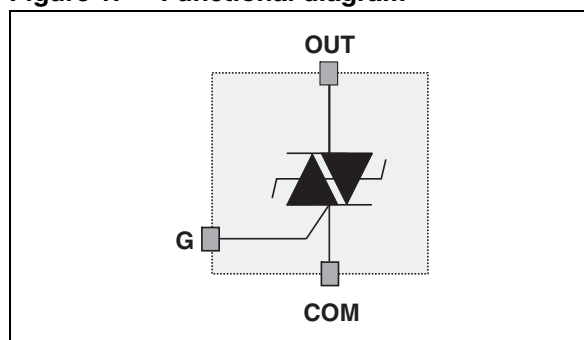

Table 1. Device summary

Symbol	Value	Unit
$I_{T(RMS)}$	12	A
$V_{DRM}/V_{RRM}$	700	V
$I_{GT}$	10 or 35	mA

# 1 Characteristics

**Table 2. Absolute ratings (limiting values)**

Symbol	Parameter		Value	Unit	
$I_{T(RMS)}$	On-state rms current full sine wave	TO-220AB D <sup>2</sup> PAK	$T_c = 104\text{ °C}$	12	A
		D <sup>2</sup> PAK with 1cm <sup>2</sup> of Cu	$T_{amb} = 47\text{ °C}$	2	
$I_{TSM}$	Non repetitive surge peak on-state current $T_j$ initial = 25 °C, ( full cycle sine wave)	F = 60 Hz	$t_p = 16.7\text{ ms}$	126	A
		F = 50 Hz	$t_p = 20.0\text{ ms}$	120	A
$I^2t$	$I^2t$ for fuse selection		$t_p = 10\text{ ms}$	95	A <sup>2</sup> s
dI/dt	Critical rate of rise on-state current $I_G = 2 \times I_{GT}$ , ( $t_r \leq 100\text{ ns}$ )	F = 120 Hz	$T_j = 125\text{ °C}$	100	A/ $\mu$ s
$V_{PP}$	Non repetitive line peak pulse voltage <sup>(1)</sup>		$T_j = 125\text{ °C}$	2	kV
$P_{G(AV)}$	Average gate power dissipation		$T_j = 125\text{ °C}$	0.1	W
$P_{GM}$	Peak gate power dissipation ( $t_p = 20\text{ }\mu$ s)		$T_j = 125\text{ °C}$	10	W
$I_{GM}$	Peak gate current ( $t_p = 20\text{ }\mu$ s)		$T_j = 125\text{ °C}$	1	A
$T_{stg}$	Storage temperature range			- 40 to + 150	°C
$T_j$	Operating junction temperature range			- 40 to + 125	°C

1. According to test described in IEC 61000-4-5 standard and [Figure 19](#)

**Table 3. Electrical characteristics**

Symbol	Test conditions	Quadrant	$T_j$		Value		Unit
					ACST12-7Sx	ACST12-7Cx	Unit
$I_{GT}^{(1)}$	$V_{OUT} = 12\text{ V}$ , $R_L = 33\text{ }\Omega$	I - II - III	25 °C	MAX.	10	35	mA
$V_{GT}$	$V_{OUT} = 12\text{ V}$ , $R_L = 33\text{ }\Omega$	I - II - III	25 °C	MAX.	1.0		V
$V_{GD}$	$V_{OUT} = V_{DRM}$ , $R_L = 3.3\text{ }\Omega$	I - II - III	125 °C	MIN.	0.2		V
$I_H^{(2)}$	$I_{OUT} = 500\text{ mA}$		25 °C	MAX.	30	50	mA
$I_L$	$I_G = 1.2 \times I_{GT}$	I - II - III	25 °C	MAX.	50	70	mA
$dV/dt^{(2)}$	$V_{OUT} = 67\% V_{DRM}$ , gate open		125 °C	MIN.	200	2000	V/ $\mu$ s
$(dI/dt)_c^{(2)}$	$(dV/dt)_c = 15\text{ V}/\mu$ s		125 °C	MIN.	5.3		A/ms
	Without snubber			MIN.	14		
$V_{CL}$	$I_{CL} = 0.1\text{ mA}$ , $t_p = 1\text{ ms}$		25 °C		850		V

1. Minimum  $I_{GT}$  is guaranteed at 5% of  $I_{GT}$  max
2. For both polarities of OUT pin referenced to COM pin

**Table 4. Static characteristics**

Symbol	Test conditions			Value	Unit
$V_{TM}^{(1)}$	$I_{OUT} = 17\text{ A}$ , $t_p = 500\ \mu\text{s}$	$T_j = 25\ ^\circ\text{C}$	MAX.	1.5	V
$V_{T0}^{(1)}$	Threshold voltage	$T_j = 125\ ^\circ\text{C}$	MAX.	0.9	V
$R_d^{(1)}$	Dynamic resistance	$T_j = 125\ ^\circ\text{C}$	MAX.	30	m $\Omega$
$I_{DRM}$ $I_{RRM}$	$V_{OUT} = V_{DRM}/V_{RRM}$	$T_j = 25\ ^\circ\text{C}$	MAX.	20	$\mu\text{A}$
		$T_j = 125\ ^\circ\text{C}$		1.5	mA

1. For both polarities of OUT pin referenced to COM pin

**Table 5. Thermal characteristics**

Symbol	Parameter		Value	Unit
$R_{th(j-c)}$	Junction to case (AC)	TO-220AB	1.5	$^\circ\text{C/W}$
		D <sup>2</sup> PAK		$^\circ\text{C/W}$
$R_{th(j-a)}$	Junction to ambient	TO-220AB	60	$^\circ\text{C/W}$
		D <sup>2</sup> PAK with 1cm <sup>2</sup> of Cu	45	$^\circ\text{C/W}$

**Figure 2. Maximum power dissipation vs. on-state rms current (full cycle)**

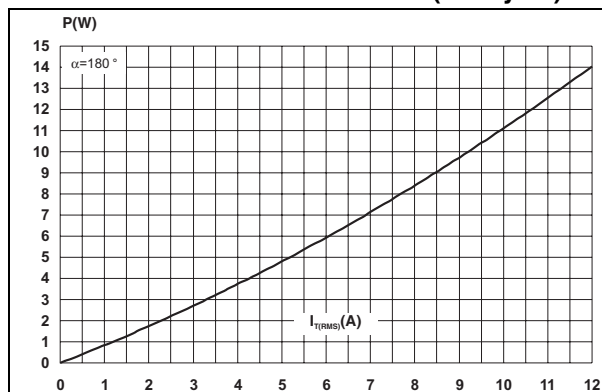

**Figure 3. On-state rms current vs. case temperature (full cycle)**

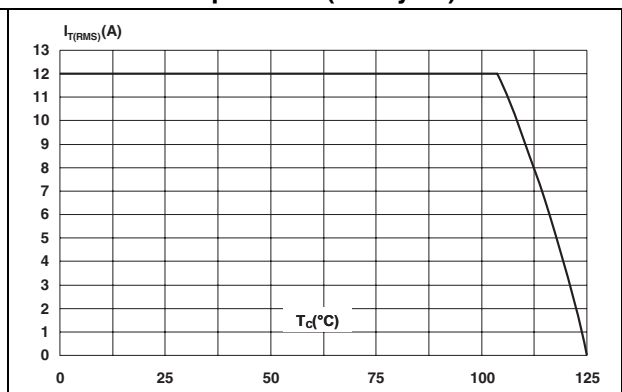

**Figure 4. On-state rms current vs. ambient temperature (free air convection full cycle)**

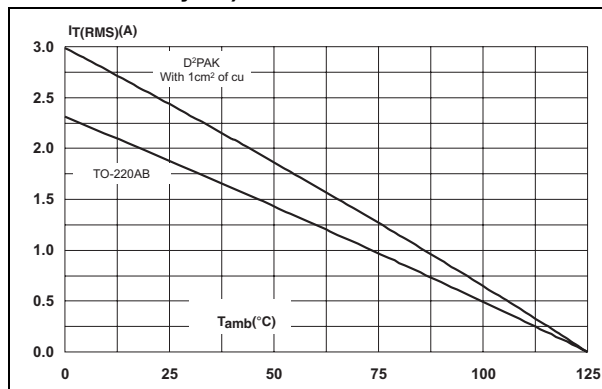

**Figure 5. Relative variation of thermal impedance vs. pulse duration**

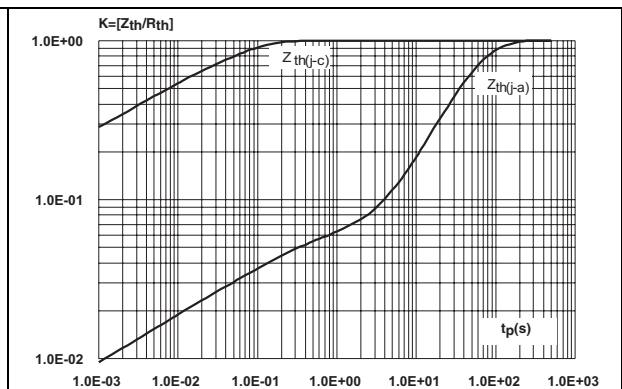

Figure 6. On-state characteristics (maximum values)

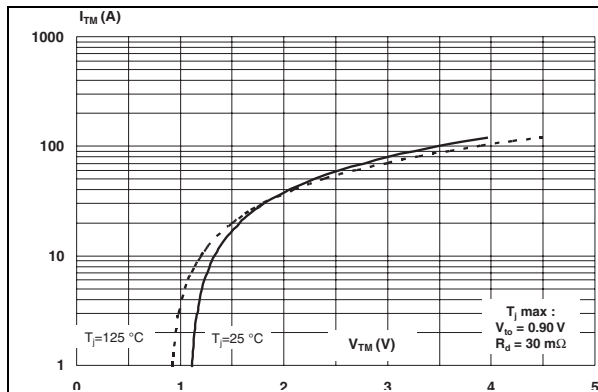

Figure 7. Non repetitive surge peak on-state current vs. number of cycles ( $T_j$  initial = 25 °C)

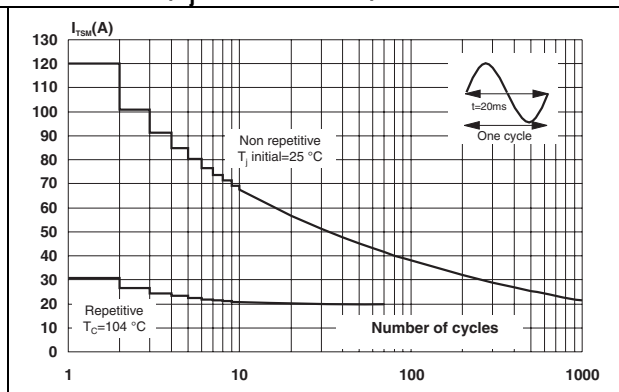

Figure 8. Non repetitive surge peak on-state current for a sinusoidal pulse and corresponding value of  $I^2t$

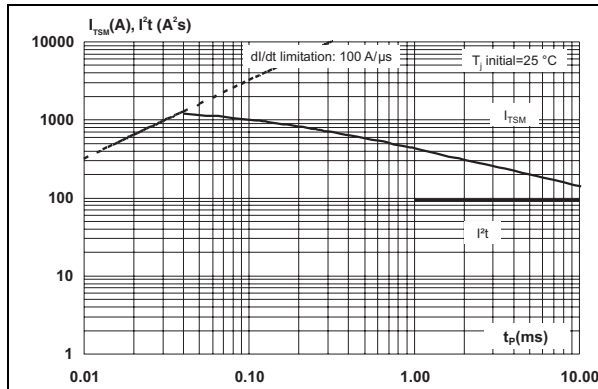

Figure 9. Relative variation of gate triggering current ( $I_{GT}$ ) and voltage ( $V_{GT}$ ) vs. junction temperature (typical value)

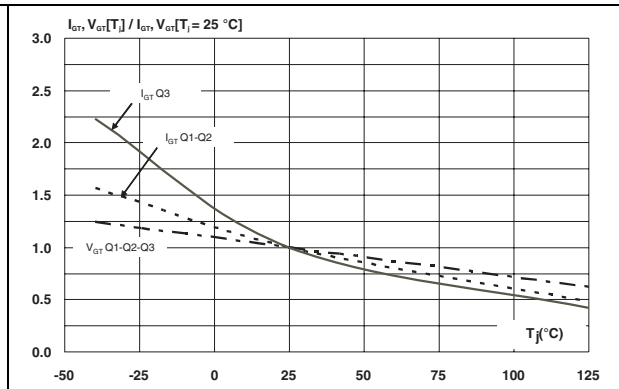

Figure 10. Relative variation of holding current ( $I_H$ ) and latching current ( $I_L$ ) vs. junction temperature

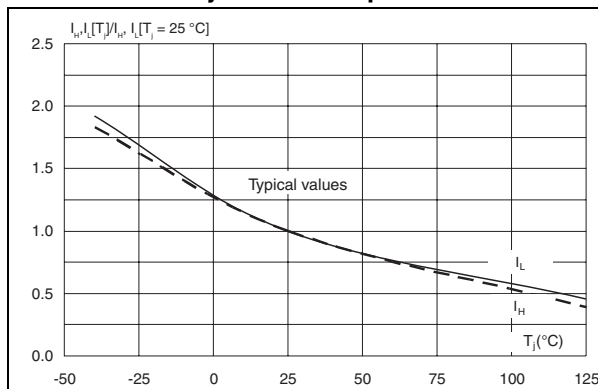
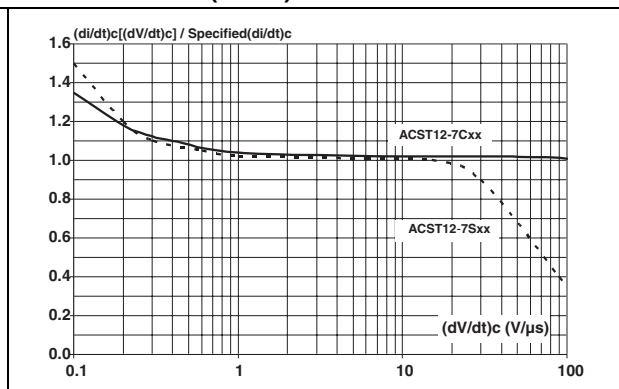
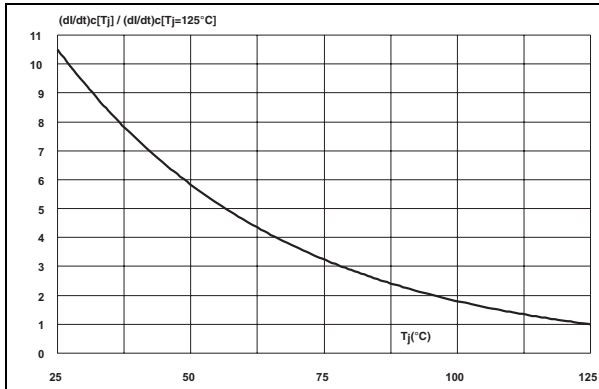

Figure 11. Relative variation of critical rate of decrease of main current ( $di/dt$ )c vs.  $(dV/dt)_c$



**Figure 12. Relative variation of critical rate of decrease of main current vs. junction temperature**



**Figure 13. Relative variation of static dV/dt immunity vs. junction temperature**

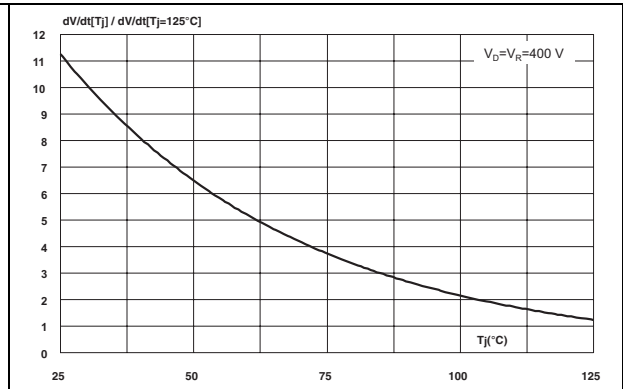

**Figure 14. Relative variation of maximum clamping voltage, V<sub>CL</sub> vs. junction temperature**

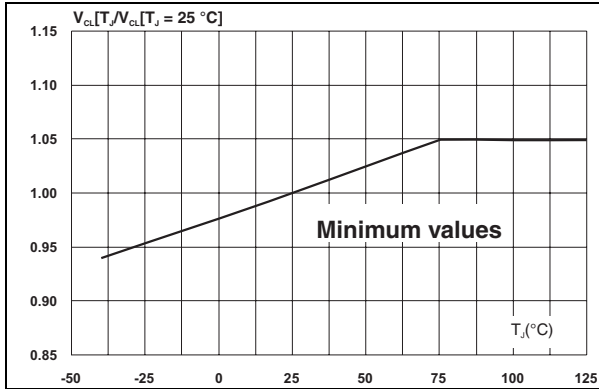

**Figure 15. Variation of thermal resistance junction to ambient vs. copper surface under tab**

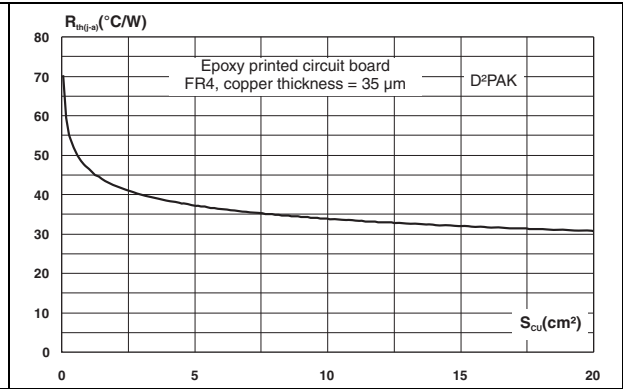

## 2 Application information

### 2.1 Typical application description

The ACST12 device has been designed to control medium power load, such as AC motors in home appliances. Thanks to its thermal and turn off commutation performances, the ACST12 switch is able to drive, with no turn off additional snubber, an inductive load up to 12 A. It also provides high thermal performances in static and transient modes such as the compressor inrush current or high torque operating conditions of an AC motor. Thanks to its low gate triggering current level, the ACST12-7S can be driven directly by a MCU through a simple gate resistor as shown in [Figure 16](#).

**Figure 16. Compressor control – typical diagram**

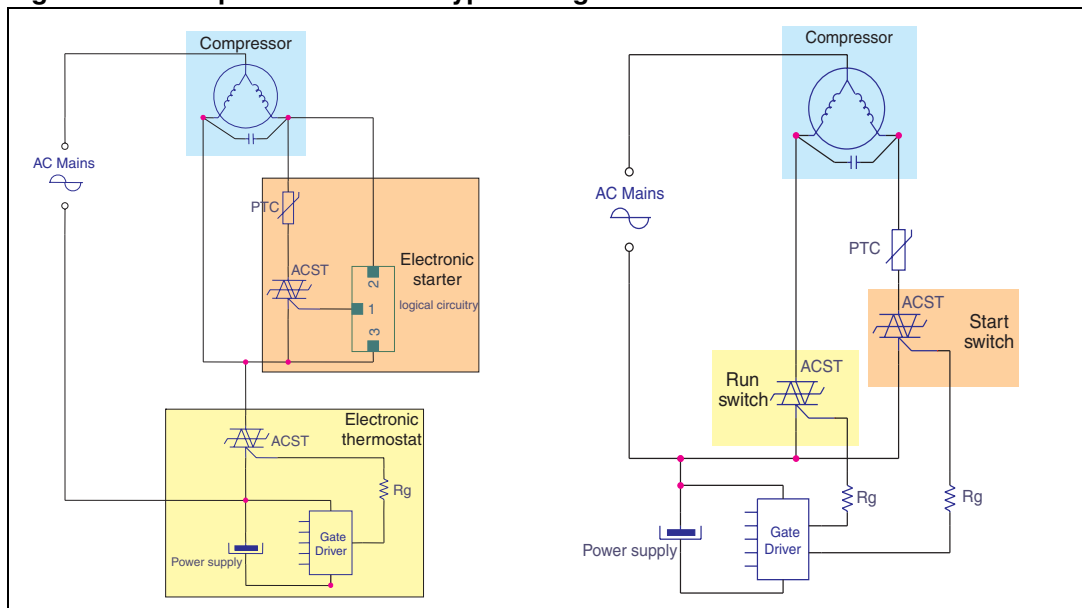
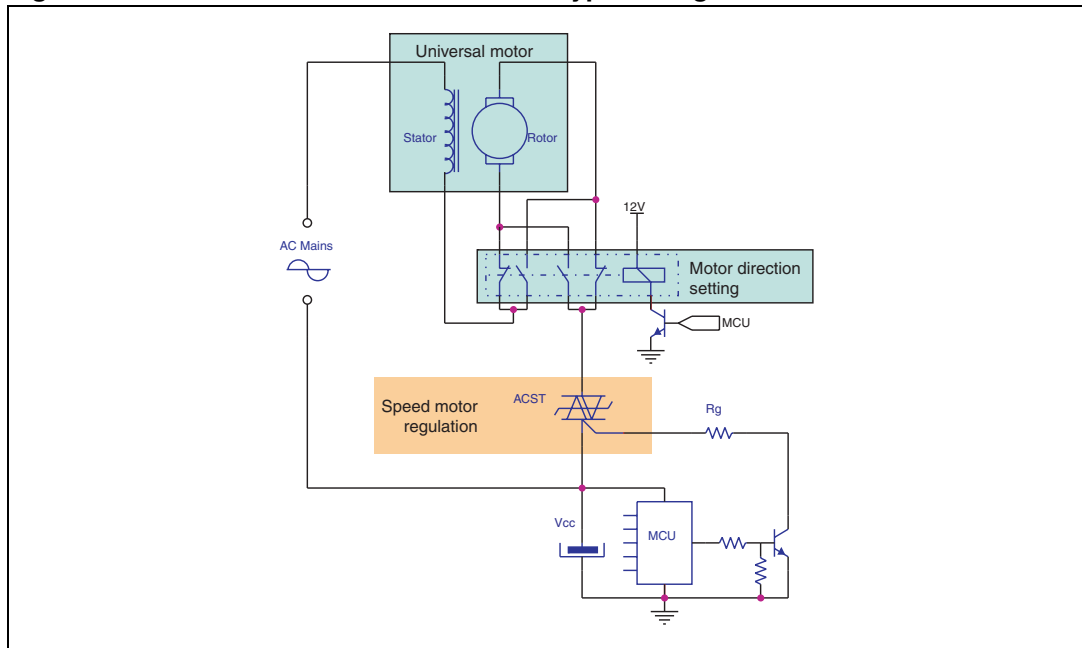

Figure 17. Universal drum motor control – typical diagram



## 2.2 AC line transient voltage ruggedness

In comparison with standard TRIACs, which are not robust against surge voltage, the ACST12 is self-protected against over-voltage, specified by the new parameter  $V_{CL}$ . The ACST12 switch can safely withstand AC line transient voltages either by clamping the low energy spikes or by switching to the on state (for less than 10 ms) to dissipate higher energy shocks through the load. This safety feature works even with high turn-on current rises.

The test circuit of [Figure 18](#) represents the ACST12 application, and is used to stress the ACST switch according to the IEC 61000-4-5 standard conditions. Thanks to the load which is limiting the current, the ACST switch withstands the voltage spikes up to 2 kV above the peak line voltage. The protection is based on an overvoltage crowbar technology. The ACST12 switches safely to the on state as shown in [Figure 19](#). The ACST12 recovers its blocking voltage capability after the surge. Such a non repetitive test can be done at least 10 times on each AC line voltage polarity.



Figure 18. Overvoltage ruggedness test circuit for resistive and inductive loads for IEC 61000-4-5 standards

Figure 19. Typical current and voltage waveforms across the ACST12 during IEC 61000-4-5 standard test

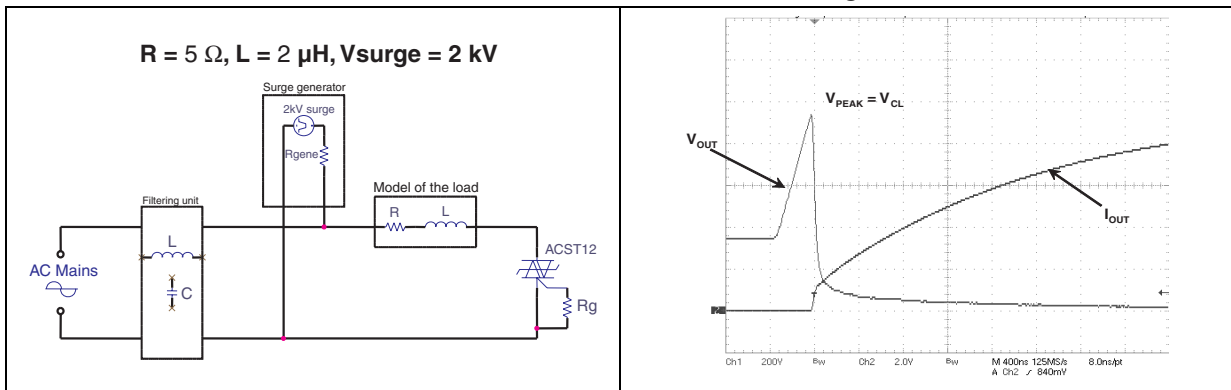

### 3 Ordering information scheme

Figure 20. Ordering information scheme

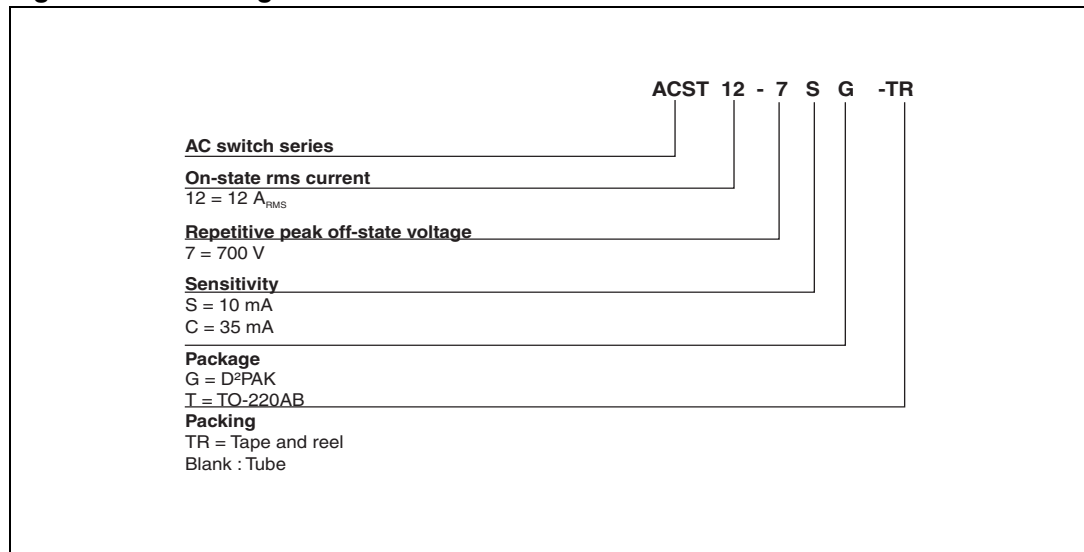

## 4 Package information

- Epoxy meets UL94, V0
- Recommended torque: 0.4 to 0.6 N·m

In order to meet environmental requirements, ST offers these devices in ECOPACK® packages. These packages have a lead-free second level interconnect. The category of second level interconnect is marked on the package and on the inner box label, in compliance with JEDEC Standard JESD97. The maximum ratings related to soldering conditions are also marked on the inner box label. ECOPACK is an ST trademark. ECOPACK specifications are available at [www.st.com](http://www.st.com).

**Table 6. TO-220AB dimensions**

Ref.	Dimensions			
	Millimeters		Inches	
	Min.	Max.	Min.	Max.
A	4.40	4.60	0.173	0.181
C	1.23	1.32	0.048	0.051
D	2.40	2.72	0.094	0.107
E	0.49	0.70	0.019	0.027
F	0.61	0.88	0.024	0.034
F1	1.14	1.70	0.044	0.066
F2	1.14	1.70	0.044	0.066
G	4.95	5.15	0.194	0.202
G1	2.40	2.70	0.094	0.106
H2	10	10.40	0.393	0.409
L2	16.4 typ.		0.645 typ.	
L4	13	14	0.511	0.551
L5	2.65	2.95	0.104	0.116
L6	15.25	15.75	0.600	0.620
L7	6.20	6.60	0.244	0.259
L9	3.50	3.93	0.137	0.154
M	2.6 typ.		0.102 typ.	
Diam.	3.75	3.85	0.147	0.151

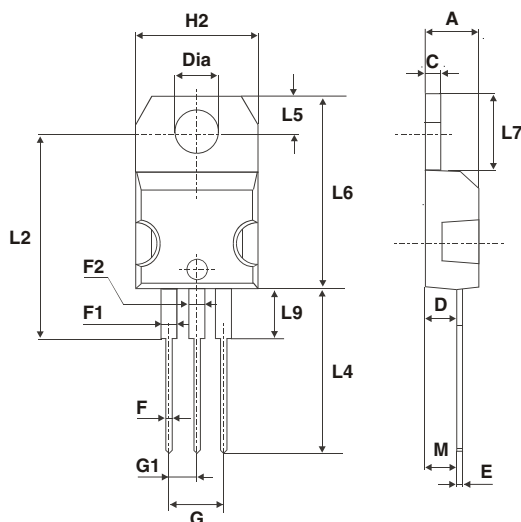
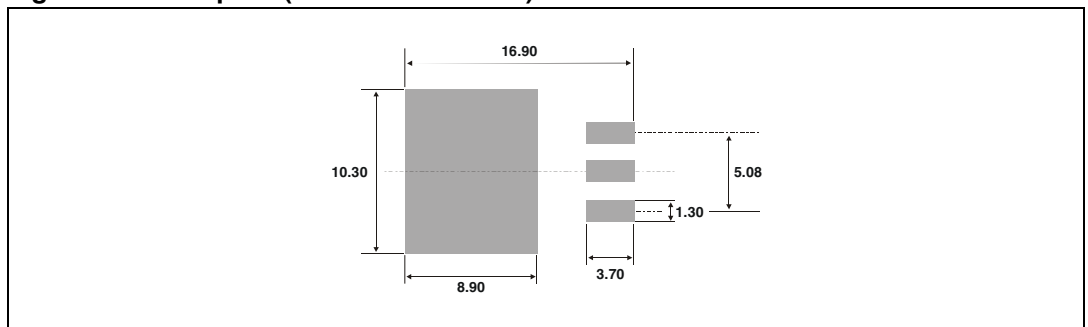

Table 7. D<sup>2</sup>PAK dimensions

Ref.	Dimensions					
	Millimeters			Inches		
	Min.	Typ.	Max.	Min.	Typ.	Max.
A	4.30		4.60	0.169		0.181
A1	2.49		2.69	0.098		0.106
A2	0.03		0.23	0.001		0.009
B	0.70		0.93	0.027		0.037
B2	1.25	1.40		0.048	0.055	
C	0.45		0.60	0.017		0.024
C2	1.21		1.36	0.047		0.054
D	8.95		9.35	0.352		0.368
E	10.00		10.28	0.393		0.405
G	4.88		5.28	0.192		0.208
L	15.00		15.85	0.590		0.624
L2	1.27		1.40	0.050		0.055
L3	1.40		1.75	0.055		0.069
R	0.40			0.016		
V2	0°		8°	0°		8°

Figure 21. Footprint (dimensions in mm)



## 5 Ordering information

**Table 8. Ordering information**

Order code	Marking	Package	Weight	Base qty	Packing mode
ACST12-7CT	ACST127C	TO-220AB	2.3 g	50	Tube
ACST12-7CG		D <sup>2</sup> PAK	1.5 g	50	Tube
ACST12-7CG-TR		D <sup>2</sup> PAK	1.5 g	1000	Tape and reel
ACST12-7ST	ACST127S	TO-220AB	2.3 g	50	Tube
ACST12-7SG		D <sup>2</sup> PAK	1.5 g	50	Tube
ACST12-7SG-TR		D <sup>2</sup> PAK	1.5 g	1000	Tape and reel

## 6 Revision history

**Table 9. Document revision history**

Date	Revision	Changes
02-Dec-2008	1	First issue

**Please Read Carefully:**

Information in this document is provided solely in connection with ST products. STMicroelectronics NV and its subsidiaries ("ST") reserve the right to make changes, corrections, modifications or improvements, to this document, and the products and services described herein at any time, without notice.

All ST products are sold pursuant to ST's terms and conditions of sale.

Purchasers are solely responsible for the choice, selection and use of the ST products and services described herein, and ST assumes no liability whatsoever relating to the choice, selection or use of the ST products and services described herein.

No license, express or implied, by estoppel or otherwise, to any intellectual property rights is granted under this document. If any part of this document refers to any third party products or services it shall not be deemed a license grant by ST for the use of such third party products or services, or any intellectual property contained therein or considered as a warranty covering the use in any manner whatsoever of such third party products or services or any intellectual property contained therein.

**UNLESS OTHERWISE SET FORTH IN ST'S TERMS AND CONDITIONS OF SALE ST DISCLAIMS ANY EXPRESS OR IMPLIED WARRANTY WITH RESPECT TO THE USE AND/OR SALE OF ST PRODUCTS INCLUDING WITHOUT LIMITATION IMPLIED WARRANTIES OF MERCHANTABILITY, FITNESS FOR A PARTICULAR PURPOSE (AND THEIR EQUIVALENTS UNDER THE LAWS OF ANY JURISDICTION), OR INFRINGEMENT OF ANY PATENT, COPYRIGHT OR OTHER INTELLECTUAL PROPERTY RIGHT.**

**UNLESS EXPRESSLY APPROVED IN WRITING BY AN AUTHORIZED ST REPRESENTATIVE, ST PRODUCTS ARE NOT RECOMMENDED, AUTHORIZED OR WARRANTED FOR USE IN MILITARY, AIR CRAFT, SPACE, LIFE SAVING, OR LIFE SUSTAINING APPLICATIONS, NOR IN PRODUCTS OR SYSTEMS WHERE FAILURE OR MALFUNCTION MAY RESULT IN PERSONAL INJURY, DEATH, OR SEVERE PROPERTY OR ENVIRONMENTAL DAMAGE. ST PRODUCTS WHICH ARE NOT SPECIFIED AS "AUTOMOTIVE GRADE" MAY ONLY BE USED IN AUTOMOTIVE APPLICATIONS AT USER'S OWN RISK.**

Resale of ST products with provisions different from the statements and/or technical features set forth in this document shall immediately void any warranty granted by ST for the ST product or service described herein and shall not create or extend in any manner whatsoever, any liability of ST.

ST and the ST logo are trademarks or registered trademarks of ST in various countries.

Information in this document supersedes and replaces all information previously supplied.

The ST logo is a registered trademark of STMicroelectronics. All other names are the property of their respective owners.

© 2008 STMicroelectronics - All rights reserved

STMicroelectronics group of companies

Australia - Belgium - Brazil - Canada - China - Czech Republic - Finland - France - Germany - Hong Kong - India - Israel - Italy - Japan - Malaysia - Malta - Morocco - Singapore - Spain - Sweden - Switzerland - United Kingdom - United States of America

[www.st.com](http://www.st.com)