

阅读申明

- 1.本站收集的数据手册和产品资料都来自互联网，版权归原作者所有。如读者和版权方有任何异议请及时告之，我们将妥善解决。
- 2.本站提供的中文数据手册是英文数据手册的中文翻译，其目的是协助用户阅读，该译文无法自动跟随原稿更新，同时也可能存在翻译上的不当。建议读者以英文原稿为参考以便获得更精准的信息。
- 3.本站提供的产品资料，来自厂商的技术支持或者使用者的心得体会等，其内容可能存在描述上的差异，建议读者做出适当判断。
- 4.如需与我们联系，请发邮件到marketing@iczoom.com，主题请标有“数据手册”字样。

Read Statement

1. The datasheets and other product information on the site are all from network reference or other public materials, and the copyright belongs to the original author and original published source. If readers and copyright owners have any objections, please contact us and we will deal with it in a timely manner.
2. The Chinese datasheets provided on the website is a Chinese translation of the English datasheets. Its purpose is for reader's learning exchange only and do not involve commercial purposes. The translation cannot be automatically updated with the original manuscript, and there may also be improper translations. Readers are advised to use the English manuscript as a reference for more accurate information.
3. All product information provided on the website refer to solutions from manufacturers' technical support or users the contents may have differences in description, and readers are advised to take the original article as the standard.
4. If you have any questions, please contact us at marketing@iczoom.com and mark the subject with "Datasheets" .



ACST4 Series

ASD™ AC Switch Family

AC POWER SWITCH

MAIN APPLICATIONS

- AC static switching in appliance control systems
- Drive of low power high inductive or resistive loads like
 - spray pump in dishwashers
 - fan in air-conditioners

FEATURES

- Blocking voltage : $V_{DRM} / V_{RRM} = +/-700V$
- Avalanche controlled : $V_{CL\ typ} = 1100 V$
- Nominal conducting current : $I_{T(RMS)} = 4A$
- High surge current capability: 30A for 20ms full wave
- Gate triggering current : $I_{GT} < 10\ mA$ or 25mA
- Switch integrated driver
- High noise immunity : static $dV/dt > 500V/\mu s$

BENEFITS

- Enables equipment to meet IEC 61000-4-5
- High off-state reliability with planar technology
- No external overvoltage protection needed
- Reduces the power component factor
- Interfaces directly with the microcontroller
- Direct interface with the microcontroller for the ACST4-7S ($I_{GT} < 10mA$)

DESCRIPTION

The ACST4 belongs to the AC power switch family built around the ASD™ technology. This high performance device is adapted to home appliances or industrial systems and drives loads up to 4 A.

The ACS™ switch embeds a Triac structure with a high voltage clamping device to absorb the inductive turn-off energy and withstand line transients such as those described in the IEC61000-4-5 standards.

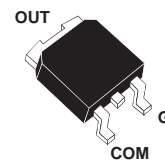

DPAK
ACST4-7SB/CB

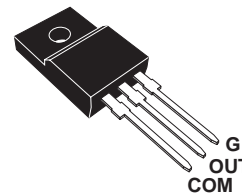

TO-220FPAB
ACST4-7SFP/CFP

FUNCTIONAL DIAGRAM

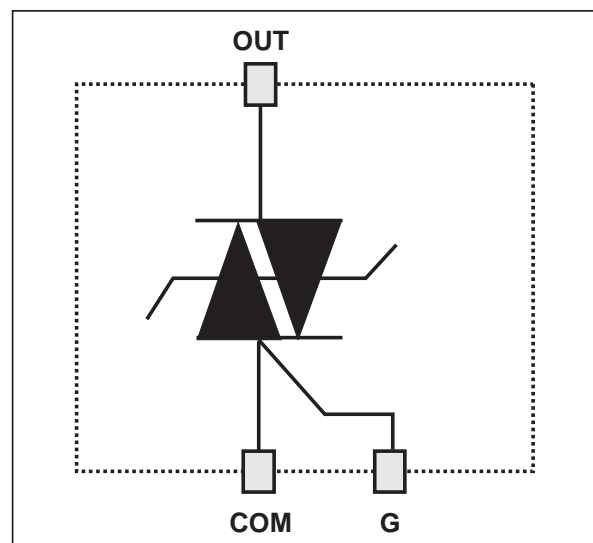

ACST4 Series

ABSOLUTE RATINGS (limiting values)

For either positive or negative polarity of pin OUT voltage in respect to pin COM voltage

Symbol	Parameter		Value	Unit	
V_{DRM} / V_{RRM}	Repetitive peak off-state voltage		$T_j = -10\text{ °C}$	700	V
$I_{T(RMS)}$	RMS on-state current full cycle sine wave 50 to 60 Hz	DPAK	$T_c = 110\text{ °C}$	4	A
		TO-220FPAB	$T_c = 100\text{ °C}$		
I_{TSM}	Non repetitive surge peak on-state current T_j initial = 25°C, full cycle sine wave		F = 50 Hz	30	A
			F = 60 Hz	33	A
I^2t	Fusing capability		$t_p = 10\text{ms}$	6.4	A ² s
di/dt	Repetitive on-state current critical rate of rise $I_G = 10\text{mA}$ ($t_r < 100\text{ns}$)	$T_j = 125\text{ °C}$	F = 120 Hz	50	A/ μs
V_{PP}	Non repetitive line peak pulse voltage		note 1	2	kV
T_{stg}	Storage temperature range			- 40 to + 150	°C
T_j	Operating junction temperature range			- 30 to + 125	°C
T_l	Maximum lead soldering temperature during 10s			260	°C

Note 1: according to test described by IEC61000-4-5 standard & Figure B.

GATE CHARACTERISTICS (maximum values)

Symbol	Parameter	Value	Unit
$P_{G(AV)}$	Average gate power dissipation	0.1	W
P_{GM}	Peak gate power dissipation ($t_p = 20\mu\text{s}$)	10	A
I_{GM}	Peak gate current ($t_p = 20\mu\text{s}$)	1	V

THERMAL RESISTANCES

Symbol	Parameter		Value	Unit
$R_{th(j-a)}$	Junction to ambient	S = 0.5cm ² DPAK	70	°C/W
		TO-220FPAB	60	°C/W
$R_{th(j-l)}$	Junction to case for full cycle sine wave conduction	DPAK	2.6	°C/W
		TO-220FPAB	4.6	°C/W

S = Copper surface under Tab

PARAMETER DESCRIPTION

Parameter Symbol	Parameter description
I_{GT}	Triggering gate current
V_{GT}	Triggering gate voltage
V_{GD}	Non-triggering gate voltage
I_H	Holding current
I_L	Latching current
V_{TM}	Peak on-state voltage drop
V_{TO}	On state threshold voltage
R_d	On state dynamic resistance
I_{DRM} / I_{RRM}	Maximum forward or reverse leakage current
dV/dt	Critical rate of rise of off-state voltage
$(dV/dt)_c$	Critical rate of rise of commutating off-state voltage
$(dI/dt)_c$	Critical rate of decrease of commutating on-state current
V_{CL}	Clamping voltage
I_{CL}	Clamping current

ELECTRICAL CHARACTERISTICS

For either positive or negative polarity of pin OUT voltage in respect to pin COM voltage.

Symbol	Test Conditions				ACST4-7S	ACST4-7C	Unit
I_{GT}	$V_{OUT}=12V$ (DC) $R_L=33\Omega$	QI - QII - QIII	$T_j=25^\circ C$	MAX	10	25	mA
V_{GT}	$V_{OUT}=12V$ (DC) $R_L=33\Omega$	QI - QII - QIII	$T_j=25^\circ C$	MAX	1	1.1	V
V_{GD}	$V_{OUT}=V_{DRM}$ $R_L=3.3k\Omega$		$T_j=125^\circ C$	MIN	0.2		V
I_H	$I_{OUT}=100mA$ gate open		$T_j=25^\circ C$	MAX	20	35	mA
I_L	$I_G=2 \times I_{GTmax}$		$T_j=25^\circ C$	MAX	40	60	mA
V_{TM}	$I_{OUT}=5.6A$ $t_p=380\mu s$		$T_j=25^\circ C$	MAX	1.5		V
V_{TO}			$T_j=125^\circ C$	MAX	0.90		V
R_d			$T_j=125^\circ C$	MAX	100		m Ω
I_{DRM} / I_{RRM}	$V_{OUT}=700V$		$T_j=25^\circ C$	MAX	10		μA
			$T_j=125^\circ C$	MAX	500		
dV/dt	$V_{OUT}=460V$ gate open		$T_j=110^\circ C$	MIN	200	500	V/ μs
$(dI/dt)_c$	$(dV/dt)_c=15V/\mu s$		$T_j=125^\circ C$	MIN	2.0	2.5	A/ms
V_{CL}	$I_{CL}=1mA$ $t_p=1ms$		$T_j=25^\circ C$	TYP	1100		V

Fig. B: Overvoltage ruggedness test circuit for resistive and inductive loads according to IEC61000-4-5 standards.
 $R = 150\Omega$, $L = 10\mu\text{H}$, $V_{PP} = 2\text{kV}$.

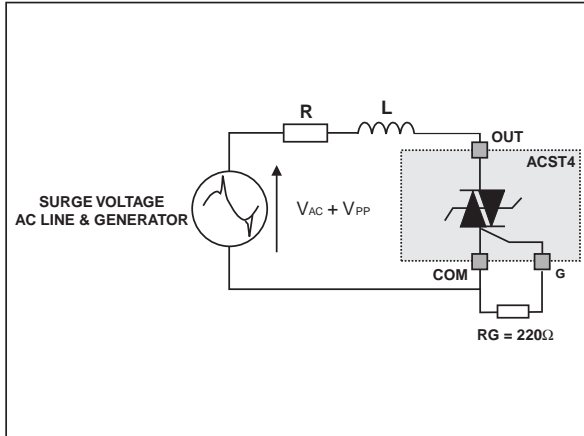

Fig. C: Current and Voltage of the ACST4 during IEC61000-4-5 standard test with R , L & V_{PP} .

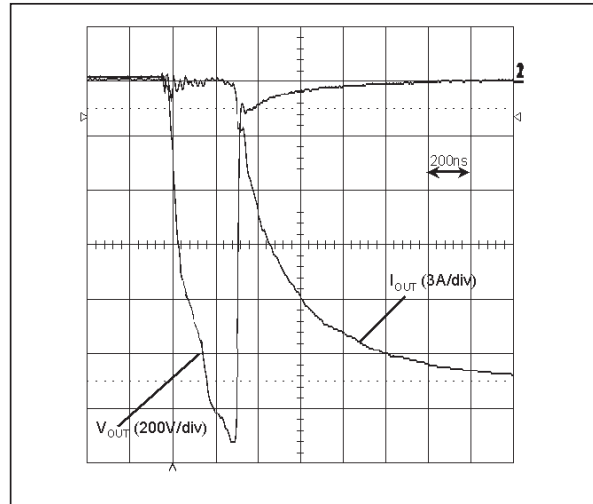

Fig. 1: Maximum power dissipation versus RMS on-state current.

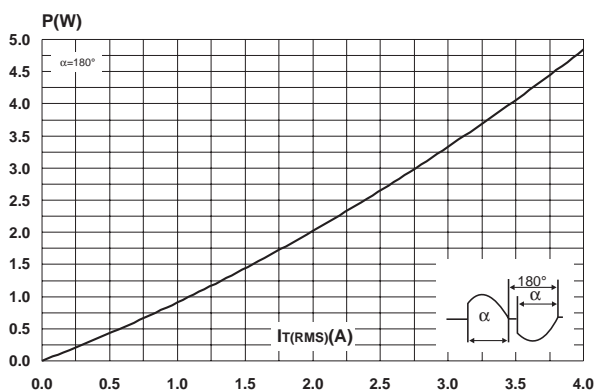

Fig. 2-1: RMS on-state current versus case temperature.

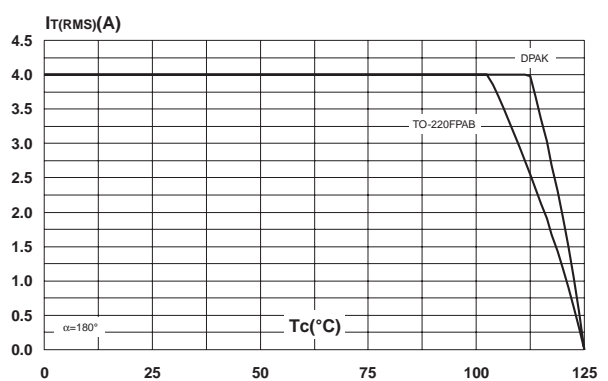

Fig. 2-2: RMS on-state current versus ambient temperature.

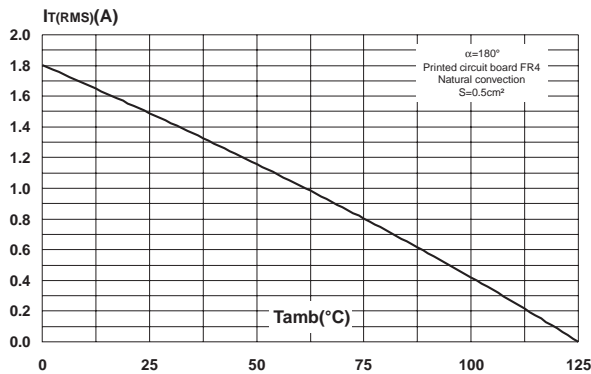

Fig. 3: Relative variation of thermal impedance versus pulse duration.

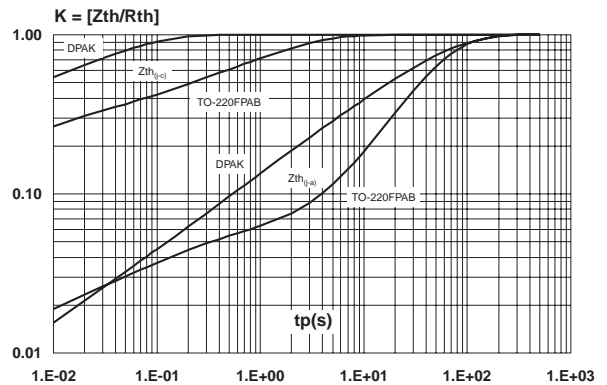

Fig. 4: Relative variation of gate trigger current, holding current and latching versus junction temperature (typical values).

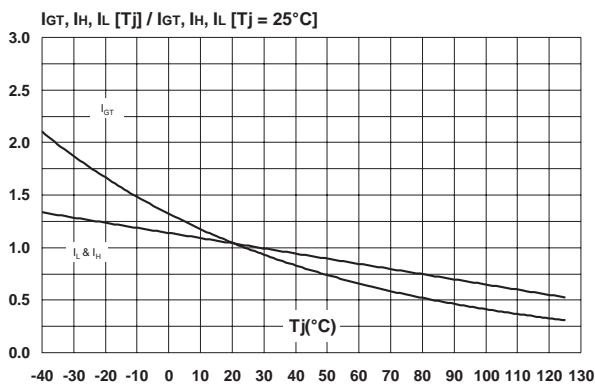

Fig. 5: Relative variation of static dV/dt versus junction temperature.

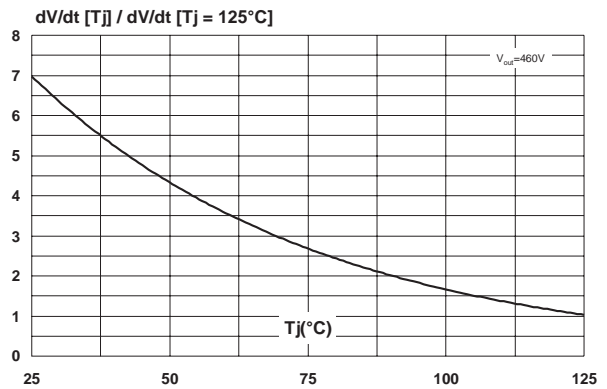

Fig. 6-1: Relative variation of critical rate of decrease of main current versus reapplied dV/dt (typical values).

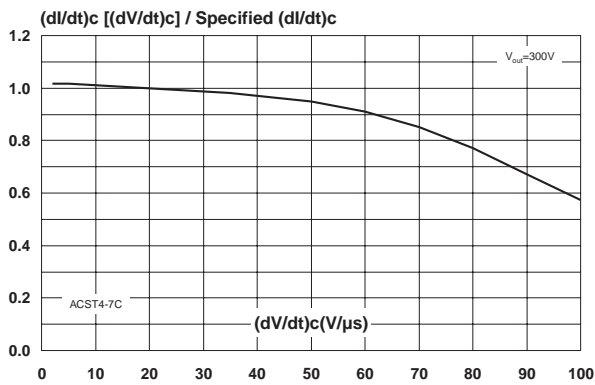

Fig. 6-2: Relative variation of critical rate of decrease of main current versus reapplied dV/dt (typical values).

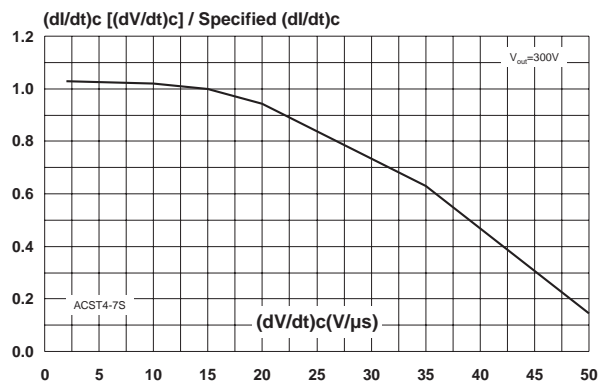

Fig. 7: Relative variation of critical rate of decrease of main current versus junction temperature.

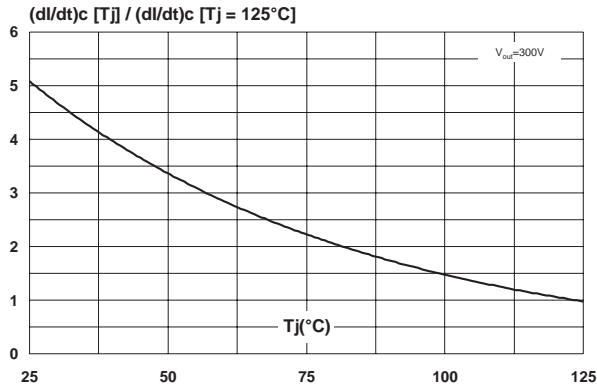

Fig. 8: Surge peak on-state current versus number of cycles.

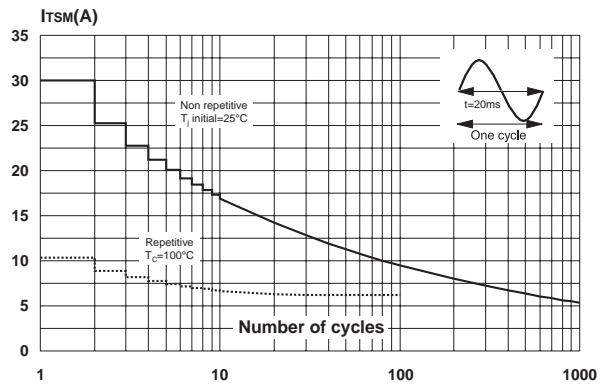

Fig. 9: Non repetitive surge peak on-state current for a sinusoidal pulse with width $t_p < 10\text{ms}$, and corresponding value of I^2t .

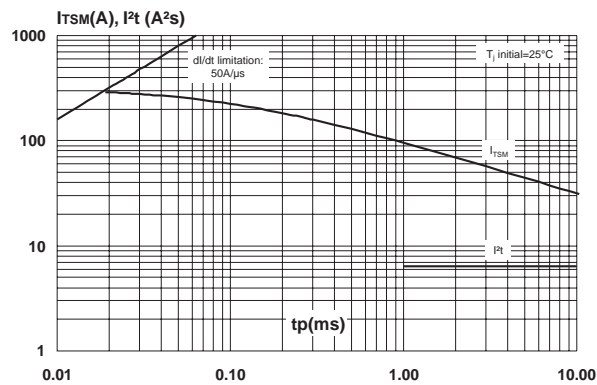

Fig. 10: On-state characteristics (maximum values).

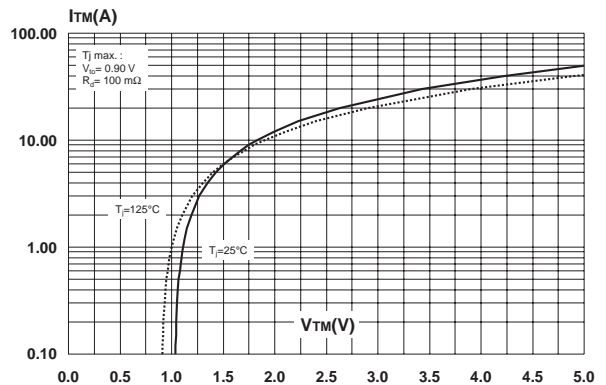
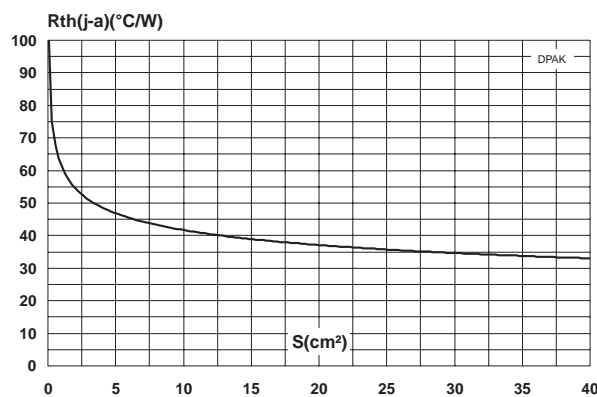
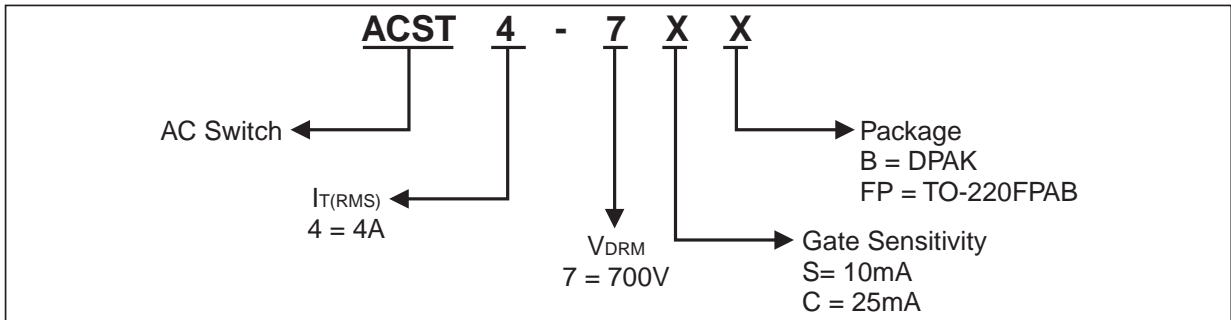

Fig. 11: Thermal resistance junction to ambient versus copper surface under tab (printed circuit board FR4, copper thickness: 35µm)



ACST4 Series

ORDERING INFORMATION



PACKAGE OUTLINE MECHANICAL DATA DPAK

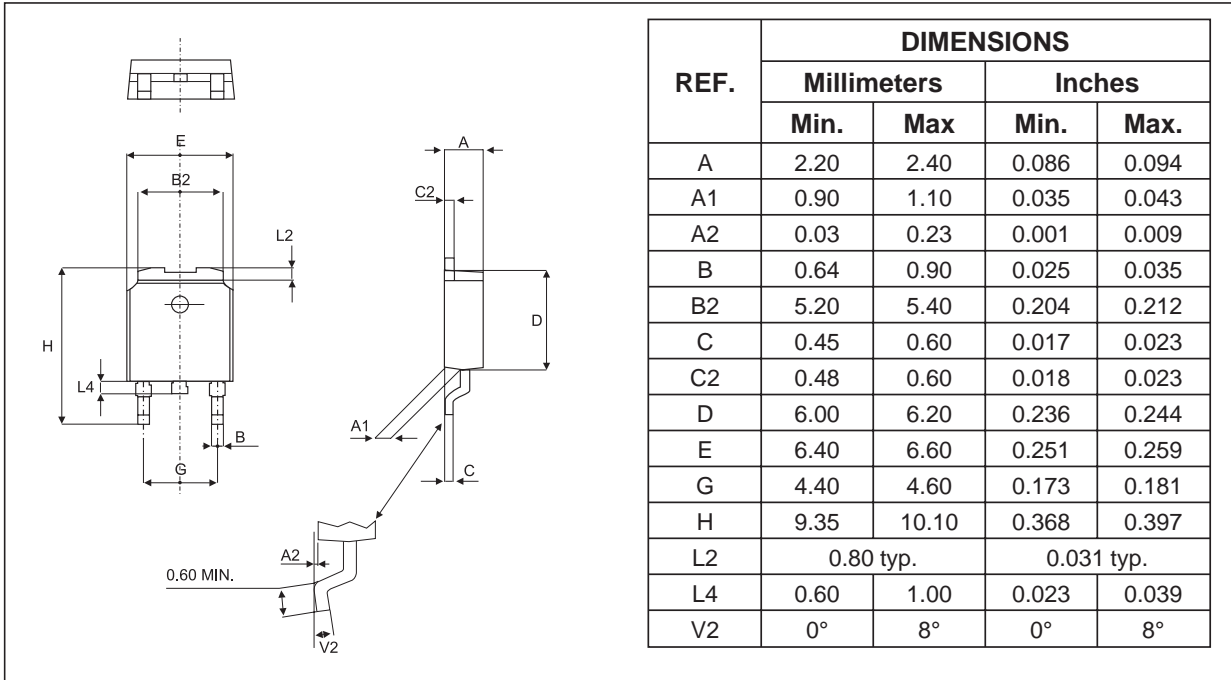

FOOT PRINT DPAK

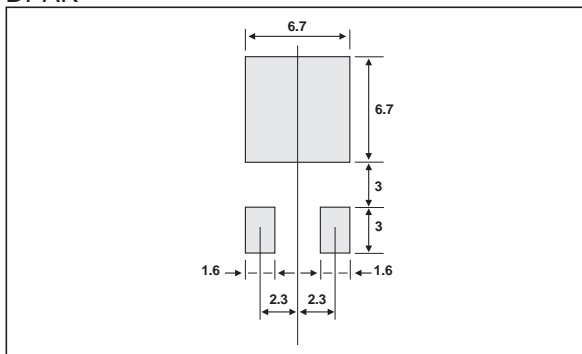

PACKAGE OUTLINE MECHANICAL DATA
TO-220FPAB

REF.	DIMENSIONS			
	Millimeters		Inches	
	Min.	Max.	Min.	Max.
A	4.4	4.6	0.173	0.181
B	2.5	2.7	0.098	0.106
D	2.5	2.75	0.098	0.108
E	0.45	0.70	0.018	0.027
F	0.75	1	0.030	0.039
F1	1.15	1.70	0.045	0.067
F2	1.15	1.70	0.045	0.067
G	4.95	5.20	0.195	0.205
G1	2.4	2.7	0.094	0.106
H	10	10.4	0.393	0.409
L2	16 Typ.		0.63 Typ.	
L3	28.6	30.6	1.126	1.205
L4	9.8	10.6	0.386	0.417
L5	2.9	3.6	0.114	0.142
L6	15.9	16.4	0.626	0.646
L7	9.00	9.30	0.354	0.366

OTHER INFORMATION

Ordering type	Marking	Package	Weight	Base qty	Delivery mode
ACST4-7SB	ACST47S	DPAK	0.3 g	75	Tube
ACST4-7SB-TR	ACST47S	DPAK	0.3 g	2500	Tape & reel
ACST4-7SFP	ACST47S	TO-220FPAB	2.4 g	50	Tube
ACST4-7CB	ACST47C	DPAK	0.3 g	75	Tube
ACST4-7CB-TR	ACST47C	DPAK	0.3 g	2500	Tape & reel
ACST4-7CFP	ACST47C	TO-220FPAB	2.4 g	50	Tube

- Epoxy meets UL94,V0

Information furnished is believed to be accurate and reliable. However, STMicroelectronics assumes no responsibility for the consequences of use of such information nor for any infringement of patents or other rights of third parties which may result from its use. No license is granted by implication or otherwise under any patent or patent rights of STMicroelectronics. Specifications mentioned in this publication are subject to change without notice. This publication supersedes and replaces all information previously supplied. STMicroelectronics products are not authorized for use as critical components in life support devices or systems without express written approval of STMicroelectronics.

The ST logo is a registered trademark of STMicroelectronics

© 2003 STMicroelectronics - Printed in Italy - All rights reserved.

STMicroelectronics GROUP OF COMPANIES

Australia - Brazil - Canada - China - Finland - France - Germany
 Hong Kong - India - Israel - Italy - Japan - Malaysia - Malta - Morocco - Singapore
 Spain - Sweden - Switzerland - United Kingdom - United States.

<http://www.st.com>

