

## 阅读申明

- 1.本站收集的数据手册和产品资料都来自互联网，版权归原作者所有。如读者和版权方有任何异议请及时告之，我们将妥善解决。
- 2.本站提供的中文数据手册是英文数据手册的中文翻译，其目的是协助用户阅读，该译文无法自动跟随原稿更新，同时也可能存在翻译上的不当。建议读者以英文原稿为参考以便获得更精准的信息。
- 3.本站提供的产品资料，来自厂商的技术支持或者使用者的心得体会等，其内容可能存在描述上的差异，建议读者做出适当判断。
- 4.如需与我们联系，请发邮件到marketing@iczoom.com，主题请标有“数据手册”字样。

## Read Statement

1. The datasheets and other product information on the site are all from network reference or other public materials, and the copyright belongs to the original author and original published source. If readers and copyright owners have any objections, please contact us and we will deal with it in a timely manner.
2. The Chinese datasheets provided on the website is a Chinese translation of the English datasheets. Its purpose is for reader's learning exchange only and do not involve commercial purposes. The translation cannot be automatically updated with the original manuscript, and there may also be improper translations. Readers are advised to use the English manuscript as a reference for more accurate information.
3. All product information provided on the website refer to solutions from manufacturers' technical support or users the contents may have differences in description, and readers are advised to take the original article as the standard.
4. If you have any questions, please contact us at marketing@iczoom.com and mark the subject with "Datasheets" .

- 8 A RMS
- Glass Passivated Wafer
- 400 V to 800 V Off-State Voltage
- Max  $I_{GT}$  of 50 mA (Quadrants 1 - 3)

TO-220 PACKAGE  
(TOP VIEW)

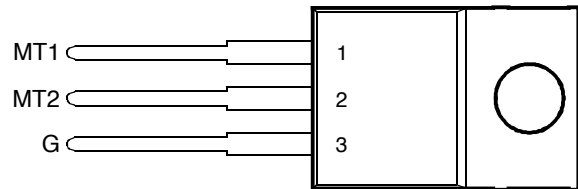

This series is currently available, but not recommended for new designs.



Pin 2 is in electrical contact with the mounting base.

MDC2ACA

**absolute maximum ratings over operating case temperature (unless otherwise noted)**

RATING		SYMBOL	VALUE	UNIT
Repetitive peak off-state voltage (see Note 1)	TIC226D	$V_{DRM}$	400	V
	TIC226M		600	
	TIC226S		700	
	TIC226N		800	
Full-cycle RMS on-state current at (or below) 85°C case temperature (see Note 2)		$I_{T(RMS)}$	8	A
Peak on-state surge current full-sine-wave at (or below) 25°C case temperature (see Note 3)		$I_{TSM}$	70	A
Peak gate current		$I_{GM}$	±1	A
Peak gate power dissipation at (or below) 85°C case temperature (pulse width ≤ 200 μs)		$P_{GM}$	2.2	W
Average gate power dissipation at (or below) 85°C case temperature (see Note 4)		$P_{G(AV)}$	0.9	W
Operating case temperature range		$T_C$	-40 to +110	°C
Storage temperature range		$T_{stg}$	-40 to +125	°C
Lead temperature 1.6 mm from case for 10 seconds		$T_L$	230	°C

- NOTES: 1. These values apply bidirectionally for any value of resistance between the gate and Main Terminal 1.  
 2. This value applies for 50-Hz full-sine-wave operation with resistive load. Above 85°C derate linearly to 110°C case temperature at the rate of 320 mA/°C.  
 3. This value applies for one 50-Hz full-sine-wave when the device is operating at (or below) the rated value of on-state current. Surge may be repeated after the device has returned to original thermal equilibrium. During the surge, gate control may be lost.  
 4. This value applies for a maximum averaging time of 20 ms.

**electrical characteristics at 25°C case temperature (unless otherwise noted)**

PARAMETER	TEST CONDITIONS			MIN	TYP	MAX	UNIT
$I_{DRM}$ Repetitive peak off-state current	$V_D = \text{rated } V_{DRM}$	$I_G = 0$	$T_C = 110^\circ\text{C}$			±2	mA
$I_{GT}$ Gate trigger current	$V_{supply} = +12\text{ V}†$	$R_L = 10\ \Omega$	$t_{p(g)} > 20\ \mu\text{s}$		6	50	mA
	$V_{supply} = +12\text{ V}†$	$R_L = 10\ \Omega$	$t_{p(g)} > 20\ \mu\text{s}$		-12	-50	
	$V_{supply} = -12\text{ V}†$	$R_L = 10\ \Omega$	$t_{p(g)} > 20\ \mu\text{s}$		-10	-50	
	$V_{supply} = -12\text{ V}†$	$R_L = 10\ \Omega$	$t_{p(g)} > 20\ \mu\text{s}$		25		
$V_{GT}$ Gate trigger voltage	$V_{supply} = +12\text{ V}†$	$R_L = 10\ \Omega$	$t_{p(g)} > 20\ \mu\text{s}$		0.7	2	V
	$V_{supply} = +12\text{ V}†$	$R_L = 10\ \Omega$	$t_{p(g)} > 20\ \mu\text{s}$		-0.8	-2	
	$V_{supply} = -12\text{ V}†$	$R_L = 10\ \Omega$	$t_{p(g)} > 20\ \mu\text{s}$		-0.8	-2	
	$V_{supply} = -12\text{ V}†$	$R_L = 10\ \Omega$	$t_{p(g)} > 20\ \mu\text{s}$		0.9	2	
$V_T$ On-state voltage	$I_T = \pm 12\text{ A}$	$I_G = 50\text{ mA}$	(see Note 5)		±1.5	±2.1	V

† All voltages are with respect to Main Terminal 1.

**PRODUCT INFORMATION**

APRIL 1971 - REVISED SEPTEMBER 2002  
 Specifications are subject to change without notice.

electrical characteristics at 25°C case temperature (unless otherwise noted) (continued)

PARAMETER	TEST CONDITIONS			MIN	TYP	MAX	UNIT
$I_H$ Holding current	$V_{supply} = +12 V \uparrow$ $V_{supply} = -12 V \uparrow$	$I_G = 0$ $I_G = 0$	Init' $I_{TM} = 100 mA$ Init' $I_{TM} = -100 mA$		10 -6	30 -30	mA
$I_L$ Latching current	$V_{supply} = +12 V \uparrow$ $V_{supply} = -12 V \uparrow$	(see Note 6)				50 -50	mA
dv/dt Critical rate of rise of off-state voltage	$V_{DRM} = \text{Rated } V_{DRM}$	$I_G = 0$	$T_C = 110^\circ C$		$\pm 100$		V/ $\mu s$
dv/dt <sub>(c)</sub> Critical rise of commutation voltage	$V_{DRM} = \text{Rated } V_{DRM}$	$I_{TRM} = \pm 12 A$	$T_C = 85^\circ C$ (see figure 7)	$\pm 5$			V/ $\mu s$

† All voltages are with respect to Main Terminal 1.

NOTES: 5. This parameter must be measured using pulse techniques,  $t_p \leq 1 ms$ , duty cycle  $\leq 2\%$ . Voltage-sensing contacts separate from the current carrying contacts are located within 3.2 mm from the device body.

6. The triacs are triggered by a 15-V (open-circuit amplitude) pulse supplied by a generator with the following characteristics:  
 $R_G = 100 \Omega$ ,  $t_{p(g)} = 20 \mu s$ ,  $t_r \leq 15 ns$ ,  $f = 1 kHz$ .

thermal characteristics

PARAMETER	MIN	TYP	MAX	UNIT
$R_{\theta JC}$ Junction to case thermal resistance			1.8	$^\circ C/W$
$R_{\theta JA}$ Junction to free air thermal resistance			62.5	$^\circ C/W$

TYPICAL CHARACTERISTICS

GATE TRIGGER CURRENT  
vs

CASE TEMPERATURE

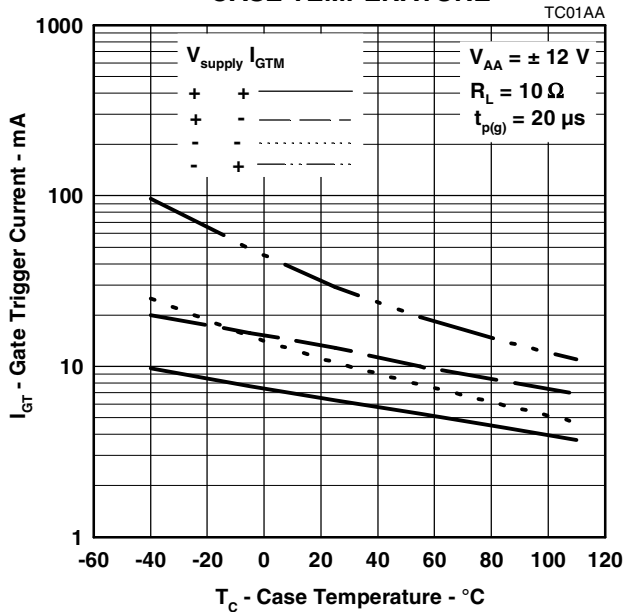

Figure 1.

GATE TRIGGER VOLTAGE  
vs

CASE TEMPERATURE

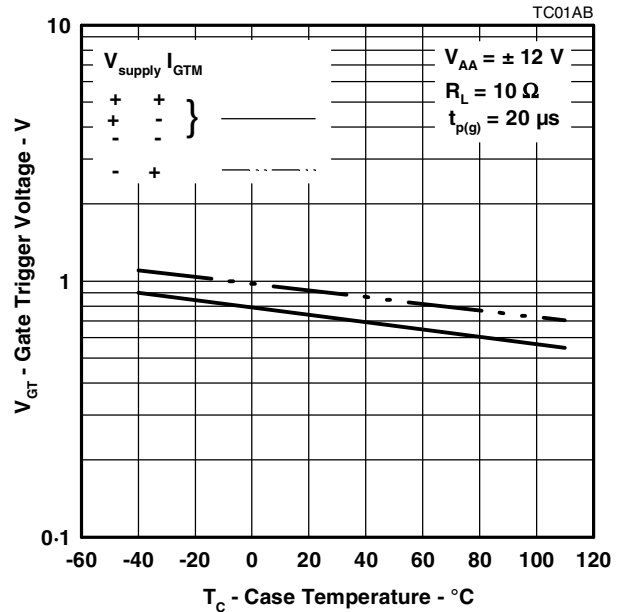

Figure 2.

**PRODUCT INFORMATION**

TYPICAL CHARACTERISTICS

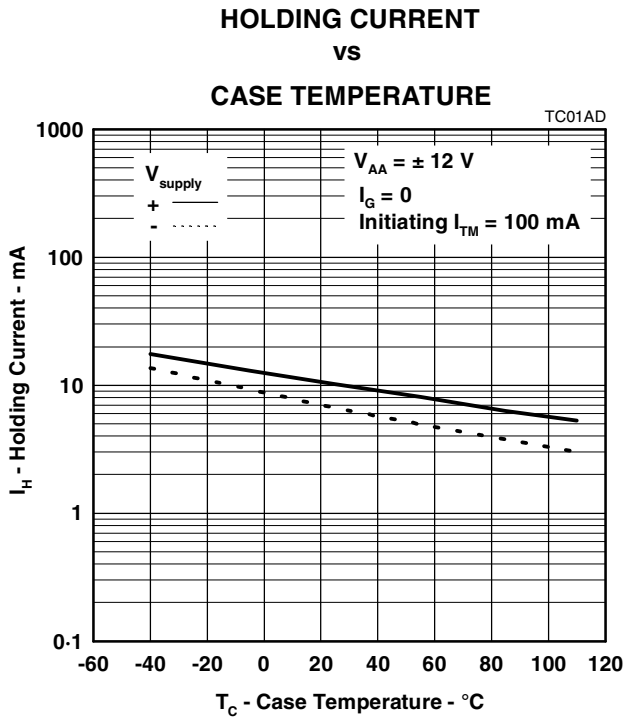

Figure 3.

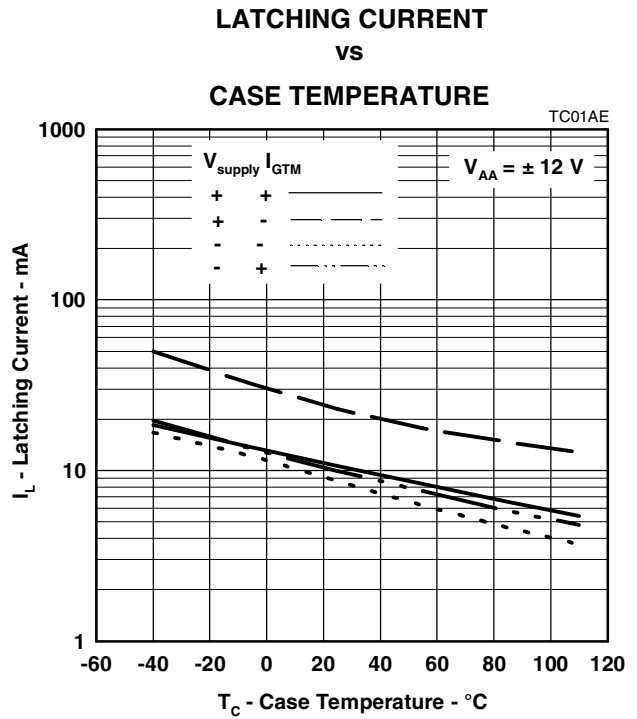

Figure 4.

THERMAL INFORMATION

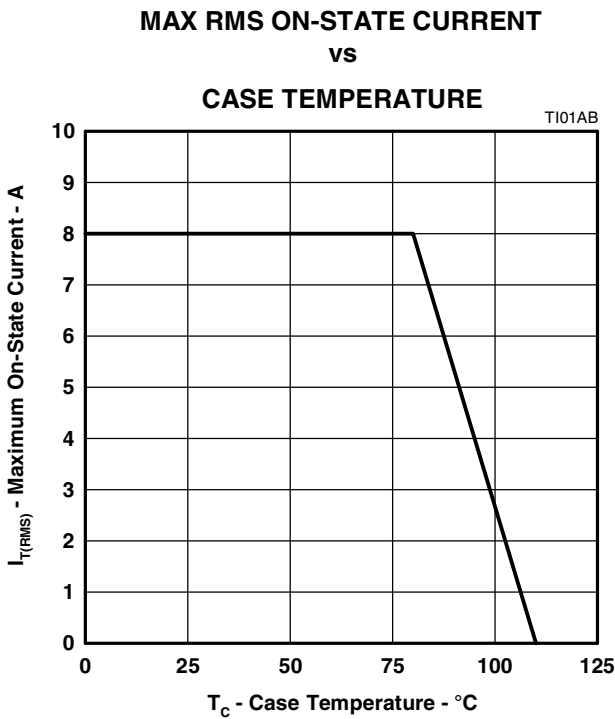

Figure 5.

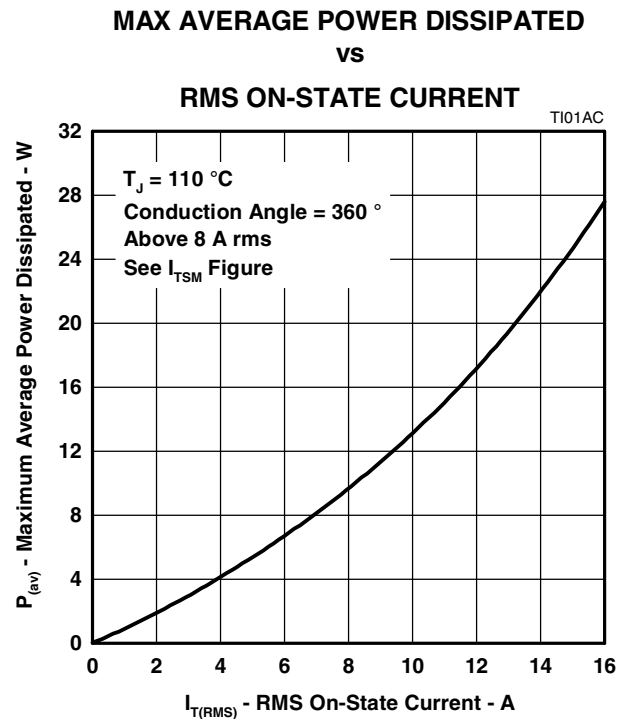
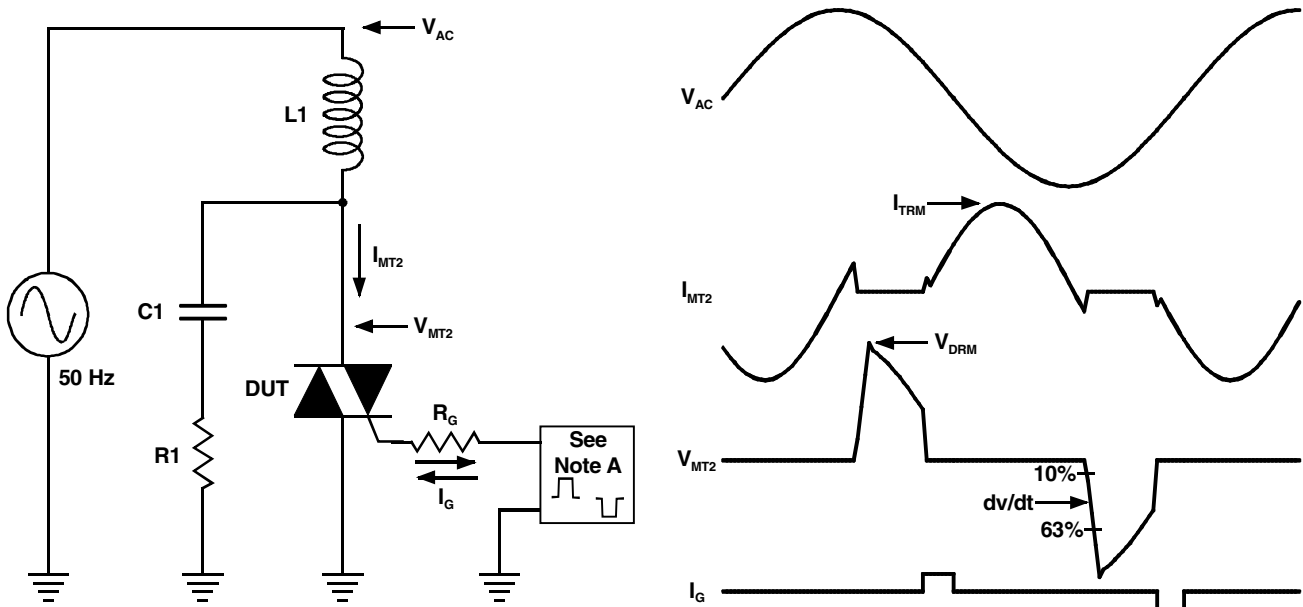

Figure 6.

**PRODUCT INFORMATION**

**PARAMETER MEASUREMENT INFORMATION**



NOTE A: The gate-current pulse is furnished by a trigger circuit which presents essentially an open circuit between pulses. The pulse is timed so that the off-state-voltage duration is approximately 800  $\mu$ s.

PMC2AA

**Figure 7.**