

阅读申明

- 1.本站收集的数据手册和产品资料都来自互联网，版权归原作者所有。如读者和版权方有任何异议请及时告之，我们将妥善解决。
- 2.本站提供的中文数据手册是英文数据手册的中文翻译，其目的是协助用户阅读，该译文无法自动跟随原稿更新，同时也可能存在翻译上的不当。建议读者以英文原稿为参考以便获得更精准的信息。
- 3.本站提供的产品资料，来自厂商的技术支持或者使用者的心得体会等，其内容可能存在描述上的差异，建议读者做出适当判断。
- 4.如需与我们联系，请发邮件到marketing@iczoom.com，主题请标有“数据手册”字样。

Read Statement

1. The datasheets and other product information on the site are all from network reference or other public materials, and the copyright belongs to the original author and original published source. If readers and copyright owners have any objections, please contact us and we will deal with it in a timely manner.
2. The Chinese datasheets provided on the website is a Chinese translation of the English datasheets. Its purpose is for reader's learning exchange only and do not involve commercial purposes. The translation cannot be automatically updated with the original manuscript, and there may also be improper translations. Readers are advised to use the English manuscript as a reference for more accurate information.
3. All product information provided on the website refer to solutions from manufacturers' technical support or users the contents may have differences in description, and readers are advised to take the original article as the standard.
4. If you have any questions, please contact us at marketing@iczoom.com and mark the subject with "Datasheets" .



Common Mode Filters

For high-speed differential signal line
(USB2.0, LVDS, etc.)

TCM-G series

| | |
|-----------------|---------------------|
| TCM0605G | [0202 inch]* |
| TCM0806G | [0302 inch] |
| TCM1608G | [0603 inch] |

* Dimensions Code JIS[EIA]

REMINDERS FOR USING THESE PRODUCTS

Before using these products, be sure to request the delivery specifications.

SAFETY REMINDERS

Please pay sufficient attention to the warnings for safe designing when using these products.

REMINDERS

- The storage period is less than 6 months. Be sure to follow the storage conditions (Temperature: 5 to 40°C, Humidity: 20 to 70% RH or less).
If the storage period elapses, the soldering of the terminal electrodes may deteriorate.
- Do not use or store in locations where there are conditions such as gas corrosion (salt, acid, alkali, etc.).
- Before soldering, be sure to preheat components.
The preheating temperature should be set so that the temperature difference between the solder temperature and chip temperature does not exceed 150°C.
- Soldering corrections after mounting should be within the range of the conditions determined in the specifications.
If overheated, a short circuit, performance deterioration, or lifespan shortening may occur.
- When embedding a printed circuit board where a chip is mounted to a set, be sure that residual stress is not given to the chip due to the overall distortion of the printed circuit board and partial distortion such as at screw tightening portions.
- Self heating (temperature increase) occurs when the power is turned ON, so the tolerance should be sufficient for the set thermal design.
- Carefully lay out the coil for the circuit board design of the non-magnetic shield type.
A malfunction may occur due to magnetic interference.
- Use a wrist band to discharge static electricity in your body through the grounding wire.
- Do not expose the products to magnets or magnetic fields.
- Do not use for a purpose outside of the contents regulated in the delivery specifications.
- The products listed on this catalog are intended for use in general electronic equipment (AV equipment, telecommunications equipment, home appliances, amusement equipment, computer equipment, personal equipment, office equipment, measurement equipment, industrial robots) under a normal operation and use condition.
The products are not designed or warranted to meet the requirements of the applications listed below, whose performance and/or quality require a more stringent level of safety or reliability, or whose failure, malfunction or trouble could cause serious damage to society, person or property.
If you intend to use the products in the applications listed below or if you have special requirements exceeding the range or conditions set forth in the each catalog, please contact us.

- (1) Aerospace/Aviation equipment
- (2) Transportation equipment (cars, electric trains, ships, etc.)
- (3) Medical equipment
- (4) Power-generation control equipment
- (5) Atomic energy-related equipment
- (6) Seabed equipment
- (7) Transportation control equipment

- (8) Public information-processing equipment
- (9) Military equipment
- (10) Electric heating apparatus, burning equipment
- (11) Disaster prevention/crime prevention equipment
- (12) Safety equipment
- (13) Other applications that are not considered general-purpose applications

When designing your equipment even for general-purpose applications, you are kindly requested to take into consideration securing protection circuit/device or providing backup circuits in your equipment.

Common Mode Filters

For high-speed differential signal line
(USB2.0, LVDS, etc.)

Product compatible with RoHS directive
Halogen-free
Compatible with lead-free solders

Overview of the TCM-G Series

FEATURES

- Thin-film common mode filter based on the thin-film processing techniques and material technology cultivated from HDD head manufacturing.
- Has EMC suppression by achieving wide frequency range (cutoff frequency of 3GHz or higher) differential mode transmission while ensuring common mode impedance with virtually no affect on the high-speed differential transmission line signal.
- Lineup includes the compact 0605 size (0.65×0.50×0.30mm) and 1608 (1.60×0.80×0.40mm) array type, etc.

APPLICATION

- Noise countermeasure for high-speed differential interfaces (USB2.0, LVDS, MIPI, etc.) for mobile devices and general consumer products such as smart phones, tablets, digital cameras, and portable music players.

PART NUMBER CONSTRUCTION

| TCM | | 0605 | | - | G | | - | 900 | | - | 2P | | - | T | | □□□ | |
|-------------|-----------------------|----------------|-----------------------|---|-------------------------|-----|-----------------|-----|-----------------|---|---------------|--|---|---|--|-----|--|
| Series name | L×W×T Dimensions (mm) | | Product internal code | | Impedance (Ω) at 100MHz | | Number of lines | | Packaging style | | Internal code | | | | | | |
| | 0605 | 0.65×0.50×0.30 | | G | | 201 | 200 | 2P | 2 lines | T | Taping | | | | | | |
| | 0806 | 0.85×0.65×0.40 | | | | 151 | 150 | 4P | 4 lines | | | | | | | | |
| | 1608 | 1.60×0.80×0.40 | | | | 900 | 90 | | | | | | | | | | |
| | | | | | | 650 | 65 | | | | | | | | | | |
| | | | | | | 350 | 35 | | | | | | | | | | |

OPERATING TEMPERATURE RANGE, PACKAGE QUANTITY, PRODUCT WEIGHT

| Type | Temperature range | | Package quantity | Individual weight |
|----------|-----------------------|----------------------|------------------|-------------------|
| | Operating temperature | Storage temperature* | | |
| | (°C) | (°C) | (pieces/reel) | (mg) |
| TCM0605G | -25 to +85 | -25 to +85 | 10,000 | 0.5 |
| TCM0806G | -25 to +85 | -25 to +85 | 10,000 | 1.0 |
| TCM1608G | -25 to +85 | -25 to +85 | 4,000 | 4.0 |

* The Storage temperature range is for after the circuit board is mounted.

- RoHS Directive Compliant Product: See the following for more details related to RoHS Directive compliant products. <http://www.tdk.co.jp/rohs/>
- Halogen-free: Indicates that Cl content is less than 900ppm, Br content is less than 900ppm, and that the total Cl and Br content is less than 1500ppm.

• All specifications are subject to change without notice.

Overview of the TCM-G Series

RECOMMENDED REFLOW PROFILE

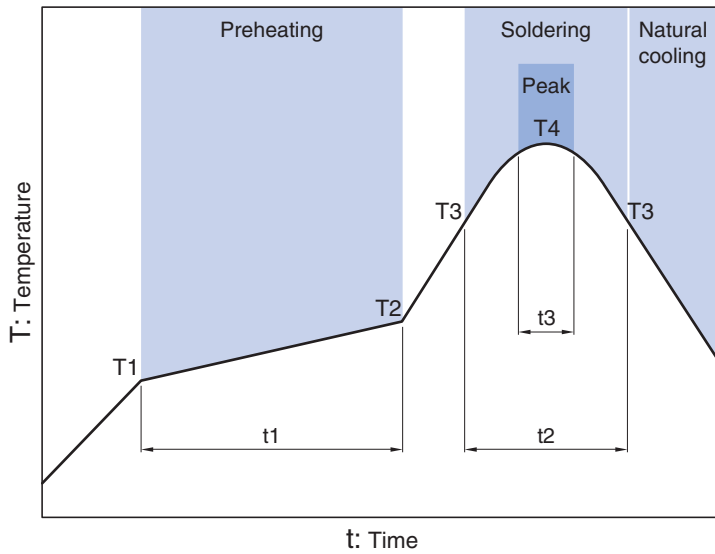

| Preheating | | | Soldering | | Peak | |
|------------|-------|------------|-----------|-----------|-------|---------|
| Temp. | Temp. | Time | Temp. | Time | Temp. | Time |
| T1 | T2 | t1 | T3 | t2 | T4 | t3 |
| 150°C | 180°C | 60 to 120s | 230°C | 10 to 30s | 245°C | 5s max. |

TCM-G series

TCM0605G Type



SHAPE & DIMENSIONS

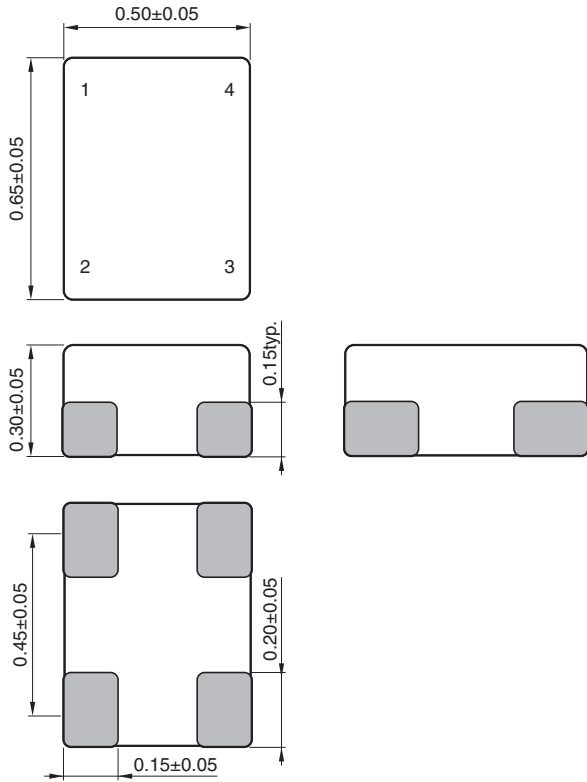

Dimensions in mm

RECOMMENDED LAND PATTERN

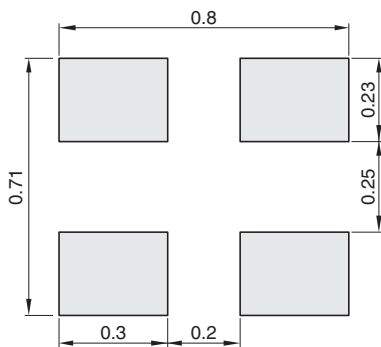

Dimensions in mm

CIRCUIT DIAGRAM

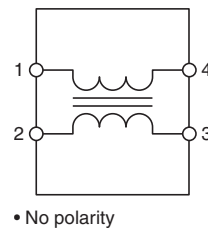

• No polarity

• All specifications are subject to change without notice.

TCM-G series TCM0605G Type

■ ELECTRICAL CHARACTERISTICS

□ CHARACTERISTICS SPECIFICATION TABLE

| Common mode impedance [at 100MHz] | | DC resistance (Ω)[1 line] | Rated current (A)max. | Rated voltage (V)max. | Insulation resistance (M Ω)min. | Part No. |
|--------------------------------------|------------|---------------------------------------|--------------------------|--------------------------|---|----------------------|
| (Ω) | Tolerance | | | | | |
| 65 | $\pm 20\%$ | 2.7 $\pm 30\%$ | 0.1 | 10 | 10 | TCM0605G-650-2P-T□□□ |
| 90 | $\pm 20\%$ | 3.0 $\pm 30\%$ | 0.1 | 10 | 10 | TCM0605G-900-2P-T□□□ |

○ Measurement equipment

| Measurement item | Product No. | Manufacturer |
|-----------------------|-------------|----------------------|
| Common mode impedance | 4291A | Agilent Technologies |
| DC resistance | 4338A | Agilent Technologies |
| Insulation resistance | 4339A | Agilent Technologies |

* Equivalent measurement equipment may be used.

TCM-G series TCM0605G Type

ELECTRICAL CHARACTERISTICS

IMPEDANCE VS. FREQUENCY CHARACTERISTICS

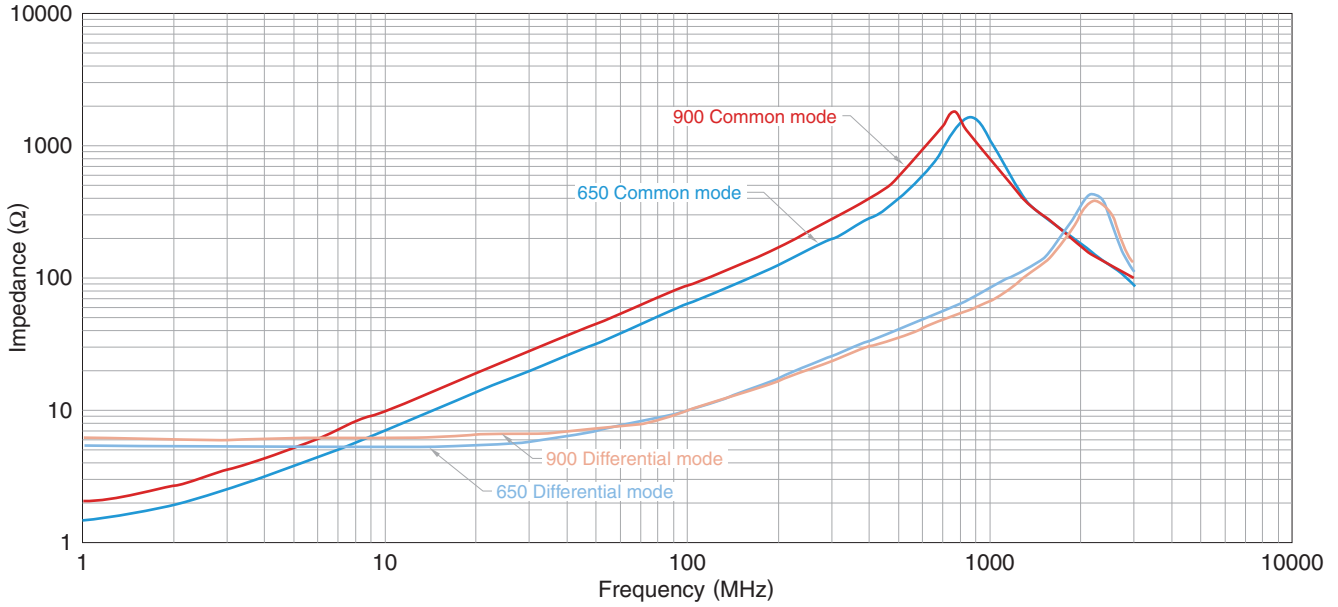

○ Measurement equipment

| Product No. | Manufacturer |
|-------------|----------------------|
| E4991A | Agilent Technologies |

* Equivalent measurement equipment may be used.

INSERTION LOSS VS. FREQUENCY CHARACTERISTICS

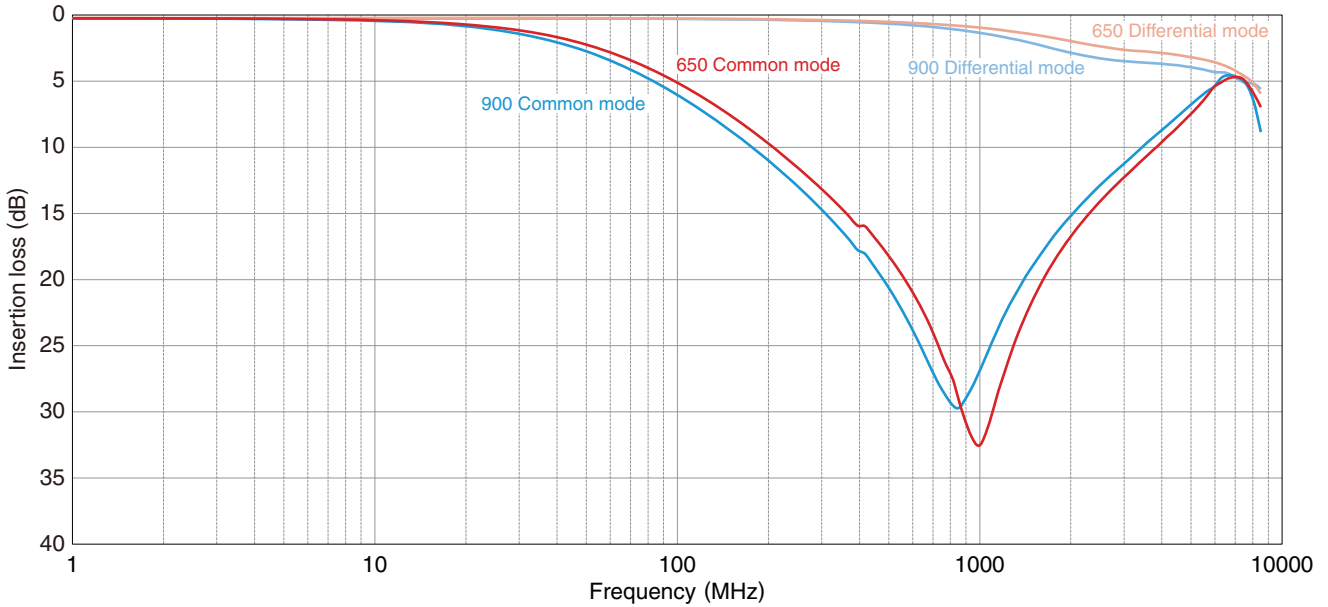

○ Measurement equipment

| Product No. | Manufacturer |
|-------------|----------------------|
| E5071B | Agilent Technologies |

* Equivalent measurement equipment may be used.

• All specifications are subject to change without notice.

TCM-G series

TCM0806G Type

SHAPE & DIMENSIONS

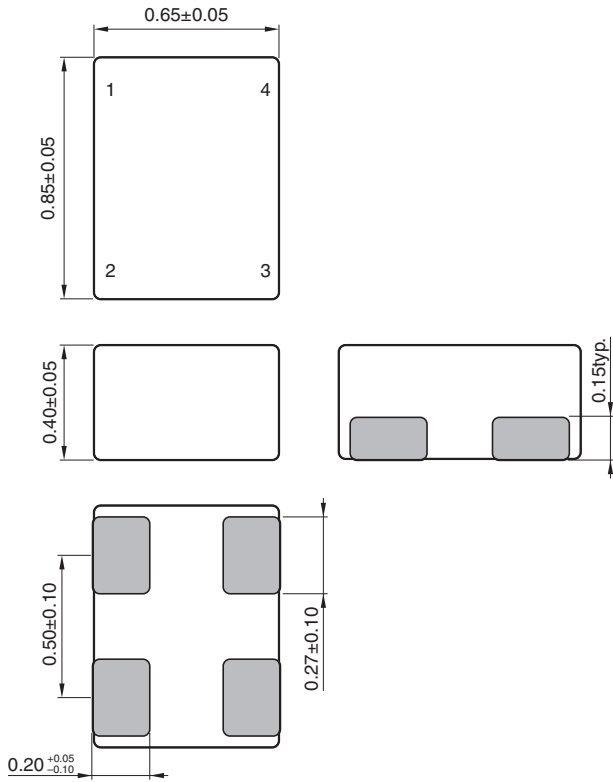

Dimensions in mm

RECOMMENDED LAND PATTERN

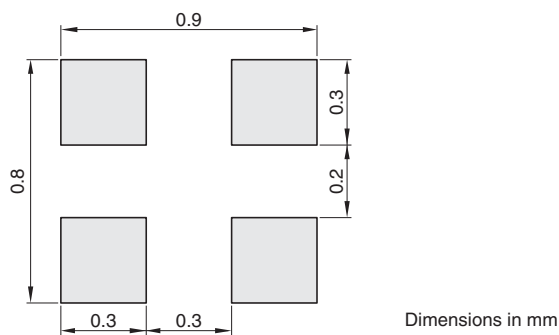

Dimensions in mm

CIRCUIT DIAGRAM

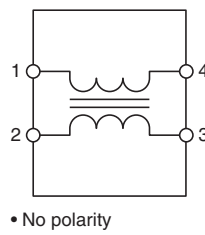

• No polarity

• All specifications are subject to change without notice.

TCM-G series TCM0806G Type

■ ELECTRICAL CHARACTERISTICS

□ CHARACTERISTICS SPECIFICATION TABLE

| Common mode impedance [at 100MHz] | | DC resistance (Ω)[1 line] | Rated current (A)max. | Rated voltage (V)max. | Insulation resistance (M Ω)min. | Part No. |
|--------------------------------------|------------|---------------------------------------|--------------------------|--------------------------|---|----------------------|
| (Ω) | Tolerance | | | | | |
| 35 | $\pm 30\%$ | 1.15 $\pm 30\%$ | 0.10 | 10 | 10 | TCM0806G-350-2P-T□□□ |
| 65 | $\pm 20\%$ | 2.50 $\pm 30\%$ | 0.10 | 10 | 10 | TCM0806G-650-2P-T□□□ |
| 90 | $\pm 20\%$ | 2.70 $\pm 30\%$ | 0.10 | 10 | 10 | TCM0806G-900-2P-T□□□ |
| 150 | $\pm 20\%$ | 3.50 $\pm 30\%$ | 0.05 | 10 | 10 | TCM0806G-151-2P-T□□□ |

○ Measurement equipment

| Measurement item | Product No. | Manufacturer |
|-----------------------|-------------|----------------------|
| Common mode impedance | 4291A | Agilent Technologies |
| DC resistance | 4338A | Agilent Technologies |
| Insulation resistance | 4339A | Agilent Technologies |

* Equivalent measurement equipment may be used.

TCM-G series TCM0806G Type

ELECTRICAL CHARACTERISTICS

IMPEDANCE VS. FREQUENCY CHARACTERISTICS

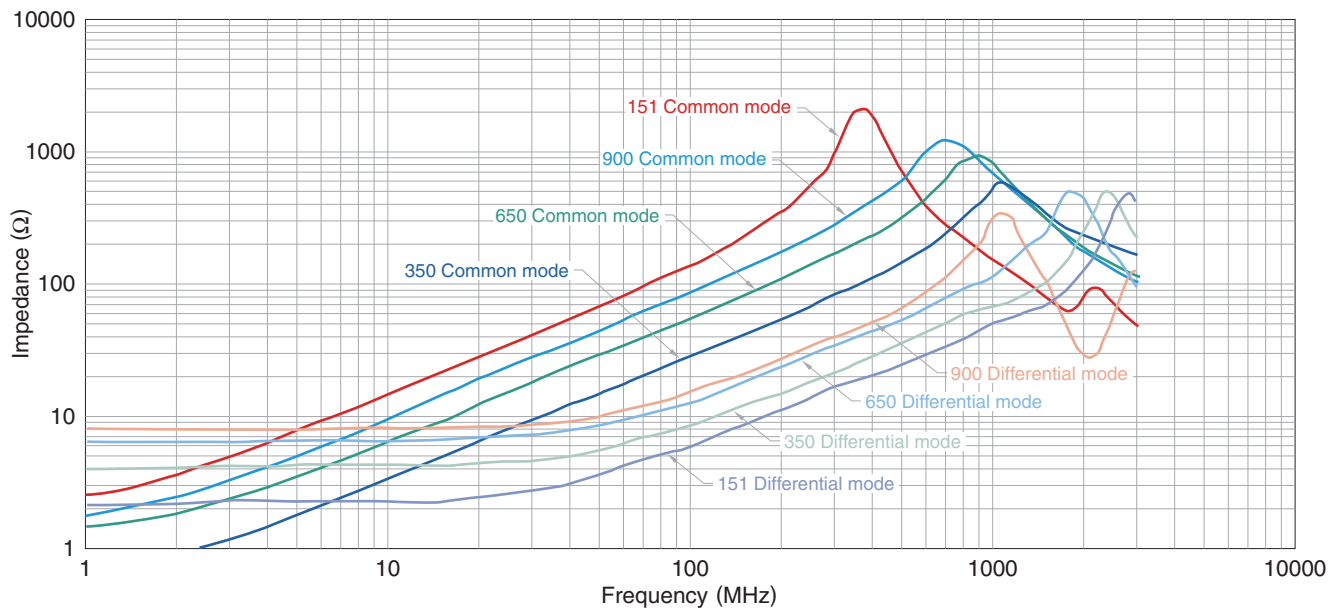

○ Measurement equipment

| Product No. | Manufacturer |
|-------------|----------------------|
| E4991A | Agilent Technologies |

* Equivalent measurement equipment may be used.

INSERTION LOSS VS. FREQUENCY CHARACTERISTICS

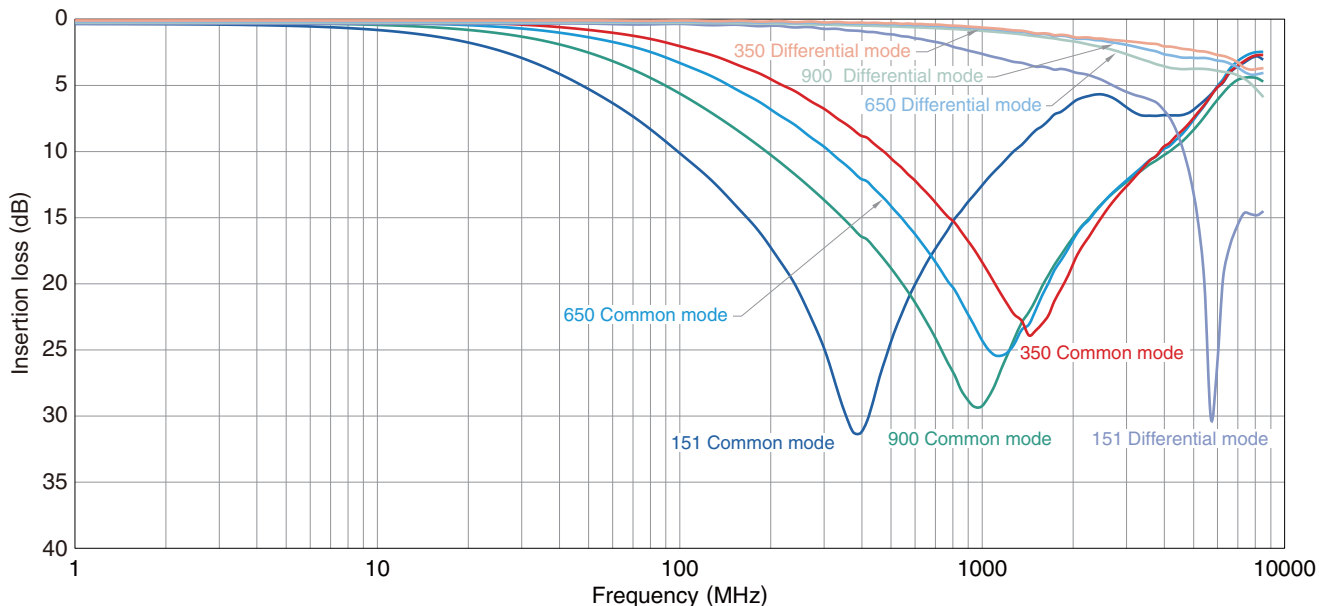

○ Measurement equipment

| Product No. | Manufacturer |
|-------------|----------------------|
| E5071B | Agilent Technologies |

* Equivalent measurement equipment may be used.

• All specifications are subject to change without notice.

TCM-G series

TCM1608G Type



SHAPE & DIMENSIONS

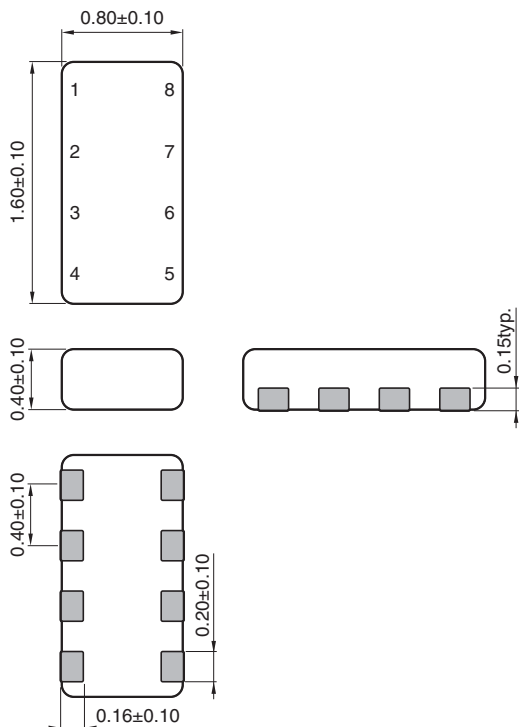

Dimensions in mm

RECOMMENDED LAND PATTERN

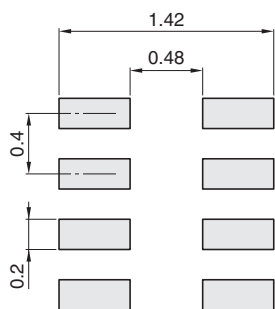

Dimensions in mm

CIRCUIT DIAGRAM

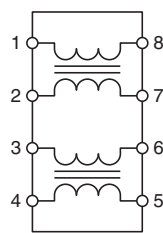

• No polarity

TCM-G series TCM1608G Type

■ ELECTRICAL CHARACTERISTICS

□ CHARACTERISTICS SPECIFICATION TABLE

| Common mode impedance [at 100MHz] | | DC resistance (Ω)[1 line] | Rated current (A)max. | Rated voltage (V)max. | Insulation resistance (M Ω)min. | Part No. |
|--------------------------------------|------------|---------------------------------------|--------------------------|--------------------------|---|----------------------|
| (Ω) | Tolerance | | | | | |
| 35 | $\pm 30\%$ | 0.85 $\pm 30\%$ | 0.10 | 5 | 10 | TCM1608G-350-4P-T□□□ |
| 65 | $\pm 20\%$ | 1.30 $\pm 30\%$ | 0.10 | 5 | 10 | TCM1608G-650-4P-T□□□ |
| 90 | $\pm 20\%$ | 1.50 $\pm 30\%$ | 0.10 | 5 | 10 | TCM1608G-900-4P-T□□□ |
| 200 | $\pm 20\%$ | 4.00 $\pm 30\%$ | 0.05 | 5 | 10 | TCM1608G-201-4P-T□□□ |

○ Measurement equipment

| Measurement item | Product No. | Manufacturer |
|-----------------------|-------------|----------------------|
| Common mode impedance | 4291A | Agilent Technologies |
| DC resistance | 4338A | Agilent Technologies |
| Insulation resistance | 4339A | Agilent Technologies |

* Equivalent measurement equipment may be used.

TCM-G series TCM1608G Type

ELECTRICAL CHARACTERISTICS

IMPEDANCE VS. FREQUENCY CHARACTERISTICS

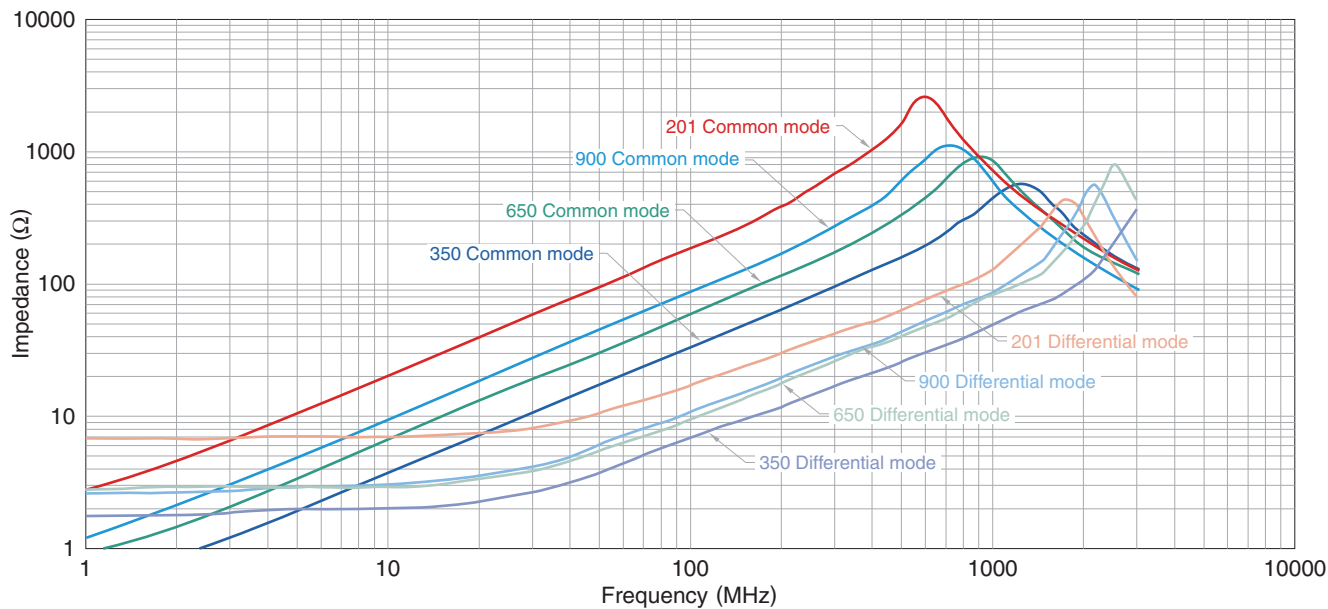

○ Measurement equipment

| Product No. | Manufacturer |
|-------------|----------------------|
| E4991A | Agilent Technologies |

* Equivalent measurement equipment may be used.

INSERTION LOSS VS. FREQUENCY CHARACTERISTICS

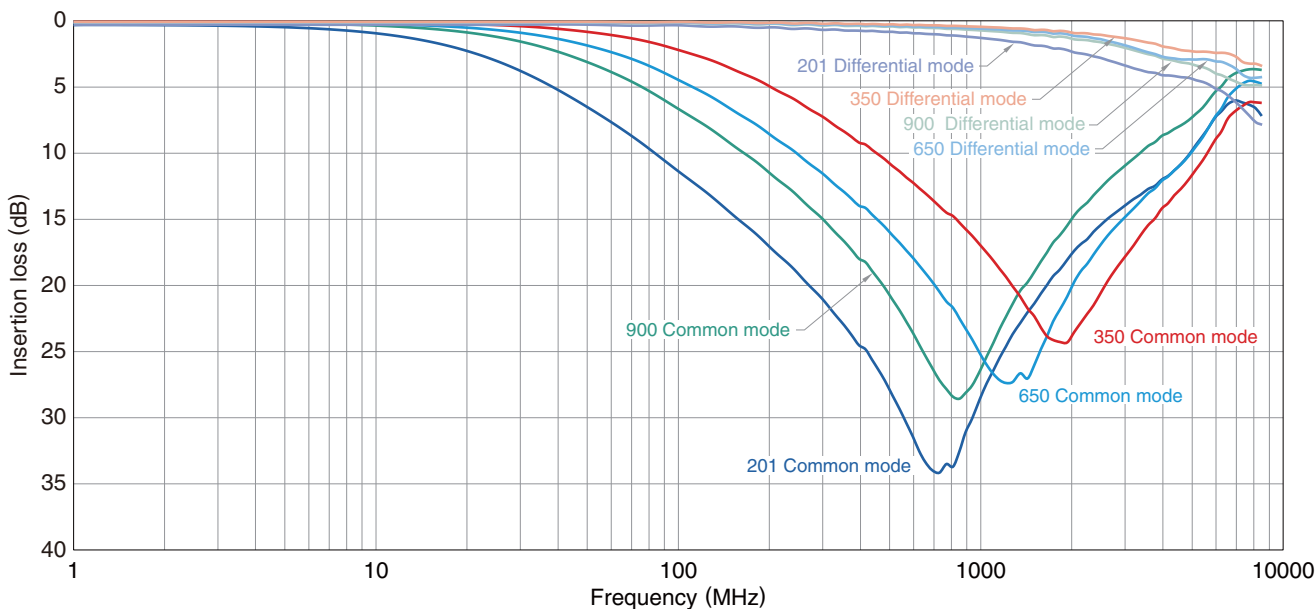

○ Measurement equipment

| Product No. | Manufacturer |
|-------------|----------------------|
| E5071B | Agilent Technologies |

* Equivalent measurement equipment may be used.

• All specifications are subject to change without notice.

TCM-G series

Packaging style

REEL DIMENSIONS

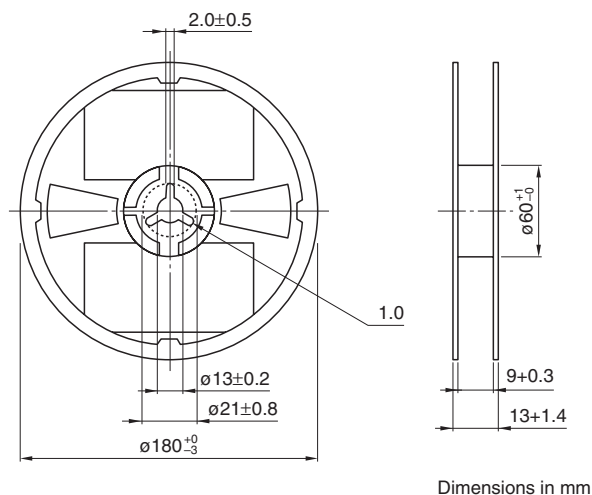

TAPE DIMENSIONS

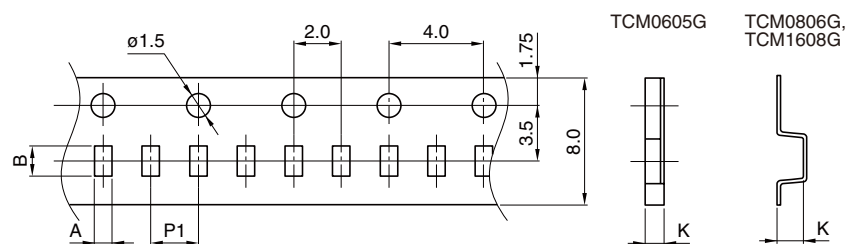

Dimensions in mm

| Type | A | B | P1 | K |
|----------|------|------|-----|------|
| TCM0605G | 0.63 | 0.77 | 2.0 | 0.35 |
| TCM0806G | 0.74 | 0.94 | 2.0 | 0.50 |
| TCM1608G | 1.00 | 1.80 | 4.0 | 0.50 |

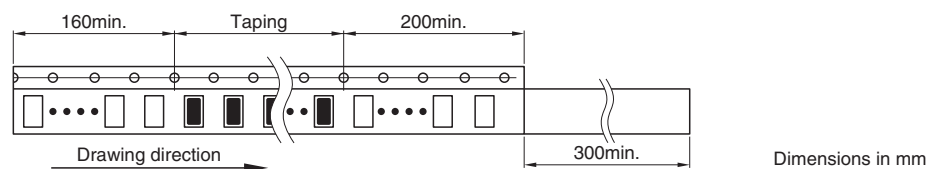

• All specifications are subject to change without notice.