

阅读申明

- 1.本站收集的数据手册和产品资料都来自互联网，版权归原作者所有。如读者和版权方有任何异议请及时告之，我们将妥善解决。
- 2.本站提供的中文数据手册是英文数据手册的中文翻译，其目的是协助用户阅读，该译文无法自动跟随原稿更新，同时也可能存在翻译上的不当。建议读者以英文原稿为参考以便获得更精准的信息。
- 3.本站提供的产品资料，来自厂商的技术支持或者使用者的心得体会等，其内容可能存在描述上的差异，建议读者做出适当判断。
- 4.如需与我们联系，请发邮件到marketing@iczoom.com，主题请标有“数据手册”字样。

Read Statement

1. The datasheets and other product information on the site are all from network reference or other public materials, and the copyright belongs to the original author and original published source. If readers and copyright owners have any objections, please contact us and we will deal with it in a timely manner.
2. The Chinese datasheets provided on the website is a Chinese translation of the English datasheets. Its purpose is for reader's learning exchange only and do not involve commercial purposes. The translation cannot be automatically updated with the original manuscript, and there may also be improper translations. Readers are advised to use the English manuscript as a reference for more accurate information.
3. All product information provided on the website refer to solutions from manufacturers' technical support or users the contents may have differences in description, and readers are advised to take the original article as the standard.
4. If you have any questions, please contact us at marketing@iczoom.com and mark the subject with "Datasheets" .

3-terminal Filters

For power line

ACH series

Type:	ACH32C	[1206 inch]*
	ACH3218	[1207 inch]
	ACH4518	[1807 inch]

* Dimensions Code [EIA]

Issue date: September 2011

- All specifications are subject to change without notice.
 - Conformity to RoHS Directive: This means that, in conformity with EU Directive 2002/95/EC, lead, cadmium, mercury, hexavalent chromium, and specific bromine-based flame retardants, PBB and PBDE, have not been used, except for exempted applications.
-

3-terminal Filters For Power Line

Conformity to RoHS Directive

ACH Series ACH32C

FEATURES

- These T-type EMC filters comprise ferrite beads and chip capacitors and are engineered to handle high current levels.
- The series offers even greater attenuation characteristics when used in a stable circuit on the ground.
- The ACH series is ideal for high-density circuit design, since the series is vertically mounted and does not require much mounting space.
- Because guarantee temperature range is -40 to $+125^{\circ}\text{C}$, it is possible to use in strict environmental condition.
- Available for reflow soldering.

APPLICATIONS

Home electronic equipment, (TVs, VCRs, CD players, DAT players, electric musical instruments, PCs, etc.), office automation equipment (computers, terminals, stand-alone word processors, fax machines, etc.), factory automation equipment (robots, numerical control devices, process controllers, etc.), automotive electronics (car navigation, ECU, etc.)

SHAPES AND DIMENSIONS/CIRCUIT DIAGRAM

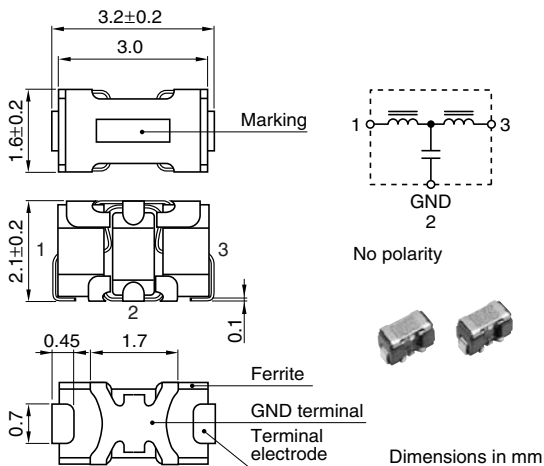

RECOMMENDED PC BOARD PATTERN REFLOW SOLDERING

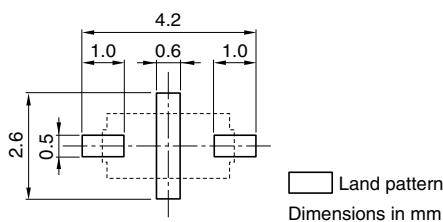

PRODUCT IDENTIFICATION

ACH 32C - 103 - T □□□
(1) (2) (3) (4) (5)

- (1) Series name
- (2) Dimensions
32C: 3216 type(3.2×1.6mm)
- (3) Capacitance
103: 10000pF
- (4) Packaging style
T: ϕ 180mm reel taping
- (5) TDK internal code

TEMPERATURE RANGES

Operating	-40 to $+125^{\circ}\text{C}$
Storage(After mount)	-40 to $+125^{\circ}\text{C}$

PACKAGING STYLE AND QUANTITIES

Packaging style	Reel	Quantity
Taping	ϕ 180mm	2000 pieces/reel

RECOMMENDED SOLDERING CONDITIONS

RECOMMENDED TEMPERATURE PROFILE FOR LEAD-FREE SOLDER

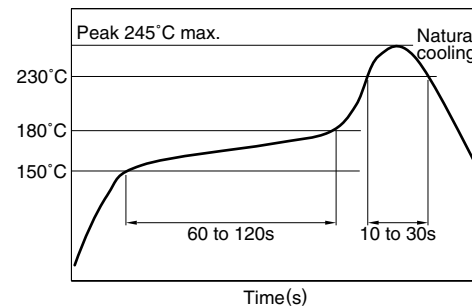

REFLOW PROFILE FOR SOLDER HEAT RESISTANCE

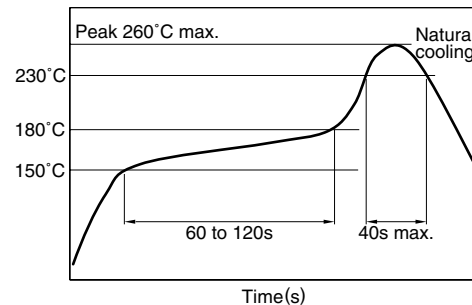

- Conformity to RoHS Directive: This means that, in conformity with EU Directive 2002/95/EC, lead, cadmium, mercury, hexavalent chromium, and specific bromine-based flame retardants, PBB and PBDE, have not been used, except for exempted applications.
- Please contact our Sales office when your application is considered the following:
The device's failure or malfunction may directly endanger human life (e.g. application for automobile/aircraft/medical/nuclear power devices, etc.)

• All specifications are subject to change without notice.

ELECTRICAL CHARACTERISTICS

Part No.	Rated voltage Edc(V)max.	Rated current (A)max.	Insulation resistance (M Ω)min.	DC resistance (m Ω)max.	Guaranteed attenuation (dB)	Guaranteed frequency bandwidth (MHz)
ACH32C-100-T001	50	6	100	2	-15	2000 to 6000
ACH32C-220-T001	50	6	100	2	-15	1300 to 2500
ACH32C-470-T001	50	6	100	2	-15	650 to 2500
ACH32C-101-T001	50	6	100	2	-20	450 to 1300
ACH32C-331-T001	50	6	100	2	-20	200 to 800
ACH32C-102-T001	50	6	100	2	-25	100 to 350
ACH32C-222-T001	50	6	100	2	-25	55 to 300
ACH32C-103-T001	50	6	100	2	-25	30 to 200
ACH32C-333-T001	50	6	100	2	-25	10 to 300
ACH32C-104-T001	50	6	100	2	-25	3.5 to 200

TYPICAL ELECTRICAL CHARACTERISTICS

ATTENUATION vs. FREQUENCY CHARACTERISTICS

(Glass epoxy coated double side mounting PCB)

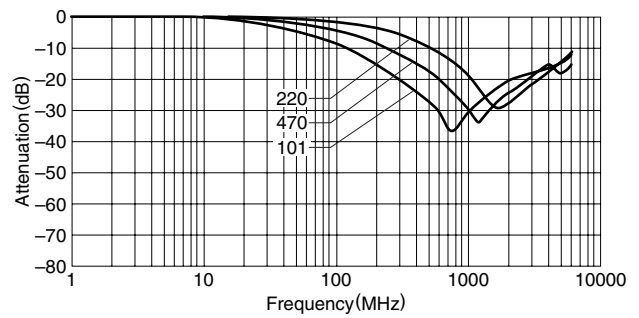
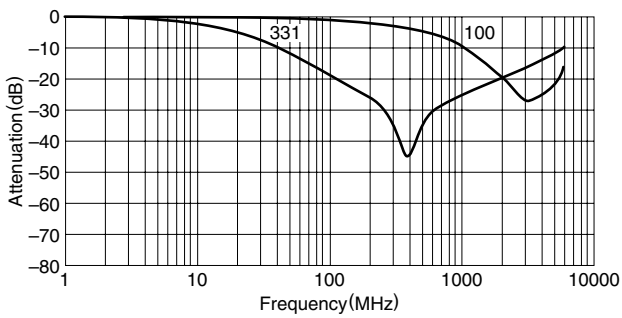
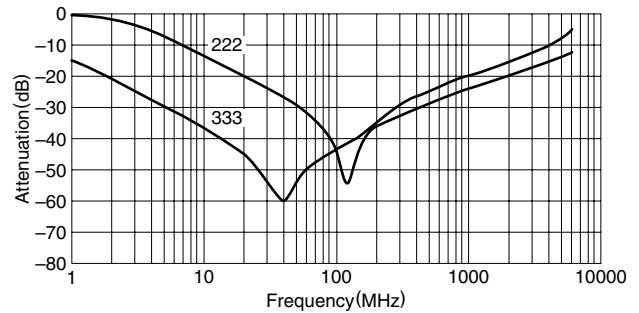
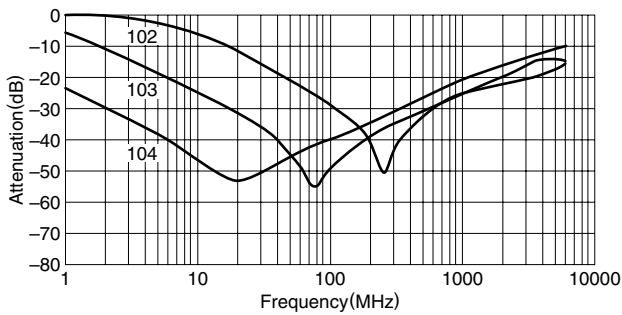

CIRCUIT DIAGRAM

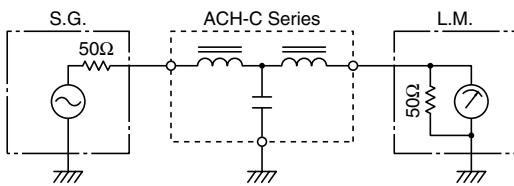

3-terminal Filters For Power Line

Conformity to RoHS Directive

ACH Series ACH3218, ACH4518

FEATURES

- The ACH series consists of products with superior attenuation characteristics, in which the T-type filter circuit is magnetically shielded with ferrite.
- The series offers even greater attenuation characteristics when used in a stable circuit on the ground.
- The ACH series is ideal for high-density circuit design, since the series is vertically mounted and does not require much mounting space.
- Available for reflow soldering.
- It is a product conforming to RoHS directive.

PRODUCT IDENTIFICATION

ACH	3218	-	223	-	T	D	□	□
(1)	(2)	(3)	(4)	(5)				

- (1) Series name
 (2) Dimensions
 (3) Type
 (4) Packaging style
 (5) TDK internal code

TEMPERATURE RANGES

Operating	-40 to +125°C
Storage(After mount)	-40 to +125°C

PACKAGING STYLE AND QUANTITIES

Packaging style	Quantity
Taping	1000 pieces/reel

HANDLING AND PRECAUTIONS

- Before soldering, be sure to preheat components. The preheating temperature should be set so that the temperature difference between the solder temperature and product temperature does not exceed 150°C.
- After mounting components onto the printed circuit board, do not apply stress through board bending or mishandling.
- The inductance value may change due to magnetic saturation if the current exceeds the rated maximum.
- Do not expose the inductors to stray magnetic fields.
- Avoid static electricity discharge during handling.
- When hand soldering, apply the soldering iron to the printed circuit board only. Temperature of the iron tip should not exceed 350°C. Soldering time should not exceed 3 seconds.

• Conformity to RoHS Directive: This means that, in conformity with EU Directive 2002/95/EC, lead, cadmium, mercury, hexavalent chromium, and specific bromine-based flame retardants, PBB and PBDE, have not been used, except for exempted applications.

• Please contact our Sales office when your application is considered the following:
 The device's failure or malfunction may directly endanger human life (e.g. application for automobile/aircraft/medical/nuclear power devices, etc.)

• All specifications are subject to change without notice.

ACH3218 TYPE SHAPES AND DIMENSIONS/CIRCUIT DIAGRAM

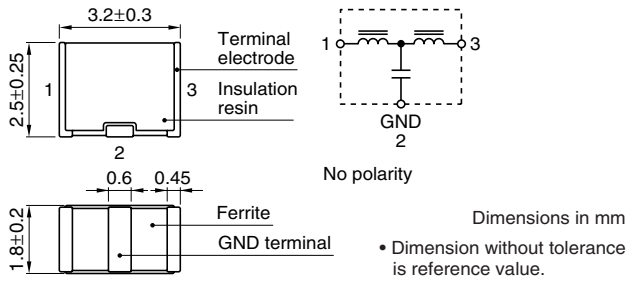

RECOMMENDED PC BOARD PATTERN REFLOW SOLDERING

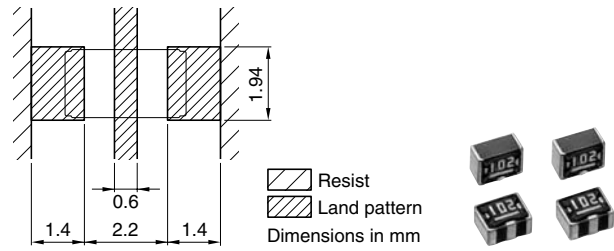

ELECTRICAL CHARACTERISTICS

Part No.	25dB attenuation frequency range (MHz)	Rated voltage Edc (V)max.	Rated current (A)max.	DC resistance (Ω)max. [Terminal No.1 to 3]	Insulation resistance (M Ω)min. [Terminal No.1 to 2/No.2 to 3]
ACH3218-223	11 to 55	20	1.5	0.06	1000
ACH3218-103	17 to 60	20	1.5	0.06	1000
ACH3218-682	22 to 75	20	1.5	0.06	1000
ACH3218-472	30 to 85	20	1.5	0.06	1000
ACH3218-332	37 to 90	20	1.5	0.06	1000
ACH3218-222	45 to 105	20	1.5	0.06	1000
ACH3218-152	60 to 115	20	1.5	0.06	1000
ACH3218-102	80 to 140	20	1.5	0.06	1000
ACH3218-681	95 to 150	20	1.5	0.06	1000
ACH3218-471	120 to 180	20	1.5	0.06	1000
ACH3218-331	130 to 210	20	1.5	0.06	1000
ACH3218-221	170 to 250	20	1.5	0.06	1000
ACH3218-151	205 to 280	20	1.5	0.06	1000
ACH3218-101	265 to 340	20	1.5	0.06	1000
ACH3218-680	340 to 420	20	1.5	0.06	1000
ACH3218-470	420 to 500	20	1.5	0.06	1000
ACH3218-330	500 to 600	20	1.5	0.06	1000
ACH3218-220	600 to 700	20	1.5	0.06	1000

TYPICAL ELECTRICAL CHARACTERISTICS ATTENUATION vs. FREQUENCY CHARACTERISTICS

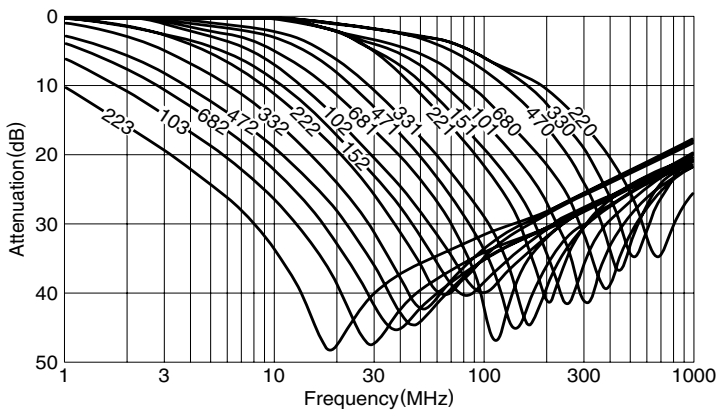

MEASURING CIRCUIT

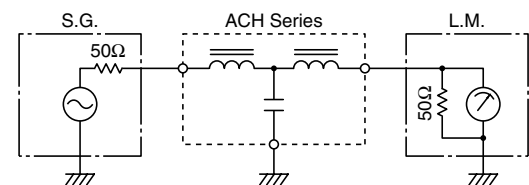

ACH4518 TYPE

SHAPES AND DIMENSIONS/CIRCUIT DIAGRAM

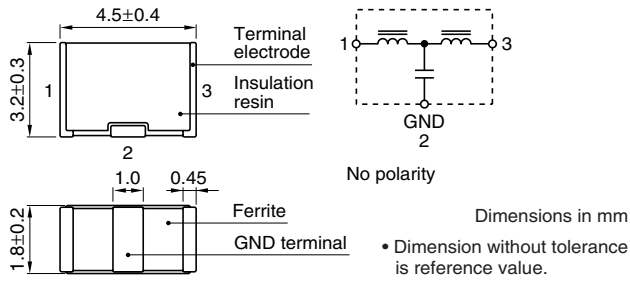

RECOMMENDED PC BOARD PATTERN REFLOW SOLDERING

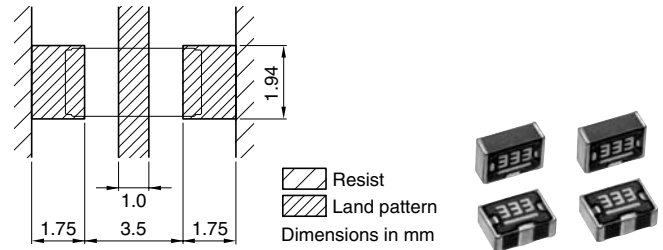

ELECTRICAL CHARACTERISTICS

Part No.	25dB attenuation frequency range (MHz)	Rated voltage E _{dc} (V)max.	Rated current (A)max.	DC resistance (Ω)max. [Terminal No.1 to 3]	Insulation resistance (MΩ)min. [Terminal No.1 to 2/No.2 to 3]
ACH4518-333	6 to 60	50	2.0	0.06	1000
ACH4518-223	9 to 65	50	2.0	0.06	1000
ACH4518-153	11 to 70	50	2.0	0.06	1000
ACH4518-103	15 to 75	50	2.0	0.06	1000
ACH4518-682	20 to 85	50	2.0	0.06	1000
ACH4518-472	25 to 90	50	2.0	0.06	1000
ACH4518-332	35 to 100	50	2.0	0.06	1000
ACH4518-222	40 to 110	50	2.0	0.06	1000
ACH4518-152	50 to 130	50	2.0	0.06	1000
ACH4518-102	65 to 150	50	2.0	0.06	1000
ACH4518-681	75 to 160	50	2.0	0.06	1000
ACH4518-471	95 to 180	50	2.0	0.06	1000
ACH4518-331	115 to 205	50	2.0	0.06	1000
ACH4518-221	150 to 250	50	2.0	0.06	1000
ACH4518-151	190 to 290	50	2.0	0.06	1000
ACH4518-101	235 to 335	50	2.0	0.06	1000
ACH4518-680	290 to 395	50	2.0	0.06	1000
ACH4518-470	360 to 460	50	2.0	0.06	1000
ACH4518-330	450 to 550	50	2.0	0.06	1000
ACH4518-220	530 to 650	50	2.0	0.06	1000

TYPICAL ELECTRICAL CHARACTERISTICS

ATTENUATION vs. FREQUENCY CHARACTERISTICS

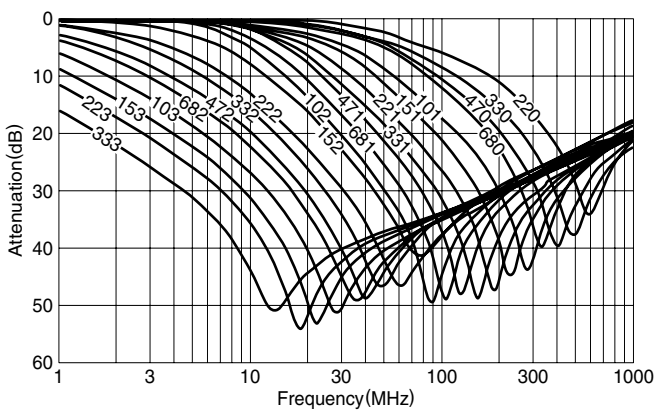

MEASURING CIRCUIT

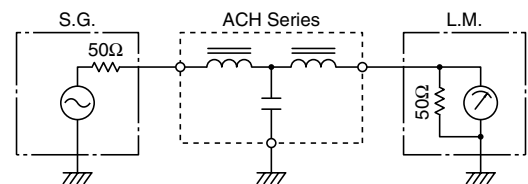

PACKAGING STYLES REEL DIMENSIONS

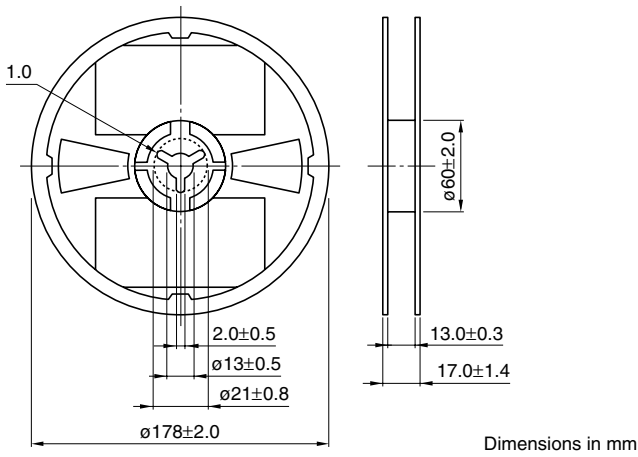

TAPE DIMENSIONS

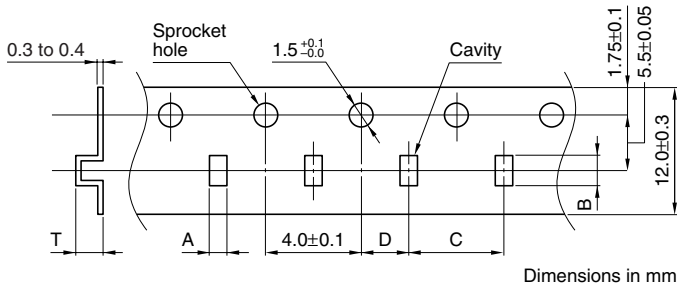

Type	A	B	C	D	T
321825	2.2 ± 0.2	3.7 ± 0.2	4.0 ± 0.1	2.0 ± 0.05	3.3max.
451832	2.2 ± 0.2	5.2 ± 0.2	4.0 ± 0.1	2.0 ± 0.05	3.8max.

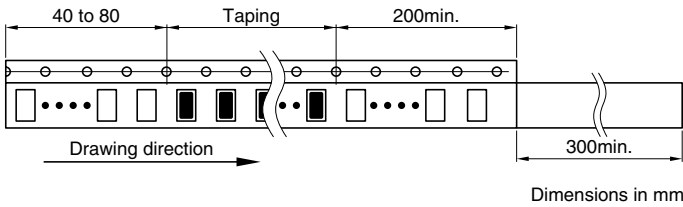

• All specifications are subject to change without notice.