

阅读申明

- 1.本站收集的数据手册和产品资料都来自互联网，版权归原作者所有。如读者和版权方有任何异议请及时告之，我们将妥善解决。
- 2.本站提供的中文数据手册是英文数据手册的中文翻译，其目的是协助用户阅读，该译文无法自动跟随原稿更新，同时也可能存在翻译上的不当。建议读者以英文原稿为参考以便获得更精准的信息。
- 3.本站提供的产品资料，来自厂商的技术支持或者使用者的心得体会等，其内容可能存在描述上的差异，建议读者做出适当判断。
- 4.如需与我们联系，请发邮件到marketing@iczoom.com，主题请标有“数据手册”字样。

Read Statement

1. The datasheets and other product information on the site are all from network reference or other public materials, and the copyright belongs to the original author and original published source. If readers and copyright owners have any objections, please contact us and we will deal with it in a timely manner.
2. The Chinese datasheets provided on the website is a Chinese translation of the English datasheets. Its purpose is for reader's learning exchange only and do not involve commercial purposes. The translation cannot be automatically updated with the original manuscript, and there may also be improper translations. Readers are advised to use the English manuscript as a reference for more accurate information.
3. All product information provided on the website refer to solutions from manufacturers' technical support or users the contents may have differences in description, and readers are advised to take the original article as the standard.
4. If you have any questions, please contact us at marketing@iczoom.com and mark the subject with "Datasheets" .

**4N25
4N37**

**4N26
H11A1**

**4N27
H11A2**

**4N28
H11A3**

**4N35
H11A4**

**4N36
H11A5**

WHITE PACKAGE (-M SUFFIX)

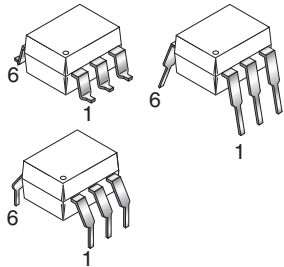

SCHEMATIC

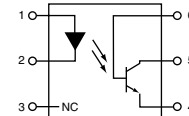

PIN 1. ANODE
2. CATHODE
3. NO CONNECTION
4. EMITTER
5. COLLECTOR
6. BASE

BLACK PACKAGE (NO -M SUFFIX)



DESCRIPTION

The general purpose optocouplers consist of a gallium arsenide infrared emitting diode driving a silicon phototransistor in a 6-pin dual in-line package.

FEATURES

- Also available in white package by specifying -M suffix, eg. 4N25-M
- UL recognized (File # E90700)
- VDE recognized (File # 94766)
 - Add option V for white package (e.g., 4N25V-M)
 - Add option 300 for black package (e.g., 4N25.300)

APPLICATIONS

- Power supply regulators
- Digital logic inputs
- Microprocessor inputs

**4N25
4N37**

**4N26
H11A1**

**4N27
H11A2**

**4N28
H11A3**

**4N35
H11A4**

**4N36
H11A5**

ABSOLUTE MAXIMUM RATINGS ($T_A = 25^\circ\text{C}$ unless otherwise specified)			
Parameter	Symbol	Value	Units
TOTAL DEVICE			
Storage Temperature	T_{STG}	-55 to +150	$^\circ\text{C}$
Operating Temperature	T_{OPR}	-55 to +100	$^\circ\text{C}$
Wave solder temperature (see page 14 for reflow solder profiles)	T_{SOL}	260 for 10 sec	$^\circ\text{C}$
Total Device Power Dissipation @ $T_A = 25^\circ\text{C}$ Derate above 25°C	P_D	250 3.3 (non-M), 2.94 (-M)	mW
EMITTER			
DC/Average Forward Input Current	I_F	100 (non-M), 60 (-M)	mA
Reverse Input Voltage	V_R	6	V
Forward Current - Peak (300 μs , 2% Duty Cycle)	$I_{F(\text{pk})}$	3	A
LED Power Dissipation @ $T_A = 25^\circ\text{C}$ Derate above 25°C	P_D	150 (non-M), 120 (-M) 2.0 (non-M), 1.41 (-M)	mW mW/ $^\circ\text{C}$
DETECTOR			
Collector-Emitter Voltage	V_{CEO}	30	V
Collector-Base Voltage	V_{CBO}	70	V
Emitter-Collector Voltage	V_{ECO}	7	V
Detector Power Dissipation @ $T_A = 25^\circ\text{C}$ Derate above 25°C	P_D	150 2.0 (non-M), 1.76 (-M)	mW mW/ $^\circ\text{C}$

**4N25
4N37**

**4N26
H11A1**

**4N27
H11A2**

**4N28
H11A3**

**4N35
H11A4**

**4N36
H11A5**

ELECTRICAL CHARACTERISTICS ($T_A = 25^\circ\text{C}$ unless otherwise specified)

INDIVIDUAL COMPONENT CHARACTERISTICS

Parameter	Test Conditions	Symbol	Min	Typ*	Max	Unit
EMITTER						
Input Forward Voltage	($I_F = 10 \text{ mA}$)	V_F		1.18	1.50	V
Reverse Leakage Current	($V_R = 6.0 \text{ V}$)	I_R		0.001	10	μA
DETECTOR						
Collector-Emitter Breakdown Voltage	($I_C = 1.0 \text{ mA}, I_F = 0$)	BV_{CEO}	30	100		V
Collector-Base Breakdown Voltage	($I_C = 100 \mu\text{A}, I_F = 0$)	BV_{CBO}	70	120		V
Emitter-Collector Breakdown Voltage	($I_E = 100 \mu\text{A}, I_F = 0$)	BV_{ECO}	7	10		V
Collector-Emitter Dark Current	($V_{CE} = 10 \text{ V}, I_F = 0$)	I_{CEO}		1	50	nA
Collector-Base Dark Current	($V_{CB} = 10 \text{ V}$)	I_{CBO}			20	nA
Capacitance	($V_{CE} = 0 \text{ V}, f = 1 \text{ MHz}$)	C_{CE}		8		pF

ISOLATION CHARACTERISTICS

Characteristic	Test Conditions	Symbol	Min	Typ*	Max	Units
Input-Output Isolation Voltage	(Non '-M', Black Package) ($f = 60 \text{ Hz}, t = 1 \text{ min}$)	V_{ISO}	5300			Vac(rms)
	('M', White Package) ($f = 60 \text{ Hz}, t = 1 \text{ sec}$)		7500			Vac(pk)
Isolation Resistance	($V_{I-O} = 500 \text{ VDC}$)	R_{ISO}	10^{11}			Ω
Isolation Capacitance	($V_{I-O} = \&, f = 1 \text{ MHz}$)	C_{ISO}		0.5		pF
	('M' White Package)			0.2	2	pF

Note

* Typical values at $T_A = 25^\circ\text{C}$

**4N25
4N37**

**4N26
H11A1**

**4N27
H11A2**

**4N28
H11A3**

**4N35
H11A4**

**4N36
H11A5**

TRANSFER CHARACTERISTICS ($T_A = 25^\circ\text{C}$ Unless otherwise specified.)

DC Characteristic	Test Conditions	Symbol	Device	Min	Typ*	Max	Unit
Current Transfer Ratio, Collector to Emitter	$(I_F = 10 \text{ mA}, V_{CE} = 10 \text{ V})$	CTR	4N35 4N36 4N37	100			%
			H11A1	50			
			H11A5	30			
	4N25 4N26 H11A2 H11A3		20				
	4N27 4N28 H11A4		10				
	4N35 4N36 4N37		40				
	$(I_F = 10 \text{ mA}, V_{CE} = 10 \text{ V}, T_A = -55^\circ\text{C})$		4N35 4N36 4N37	40			
	$(I_F = 10 \text{ mA}, V_{CE} = 10 \text{ V}, T_A = +100^\circ\text{C})$		4N35 4N36 4N37	40			
Collector-Emitter Saturation Voltage	$(I_C = 2 \text{ mA}, I_F = 50 \text{ mA})$	$V_{CE(SAT)}$	4N25 4N26 4N27 4N28			0.5	V
	$(I_C = 0.5 \text{ mA}, I_F = 10 \text{ mA})$		4N35 4N36 4N37			0.3	
			H11A1 H11A2 H11A3 H11A4 H11A5			0.4	
AC Characteristic							
Non-Saturated Turn-on Time	$(I_F = 10 \text{ mA}, V_{CC} = 10 \text{ V}, R_L = 100\Omega)$ (Fig.20)	T_{ON}	4N25 4N26 4N27 4N28 H11A1 H11A2 H11A3 H11A4 H11A5		2		μs
Non Saturated Turn-on Time	$(I_C = 2 \text{ mA}, V_{CC} = 10 \text{ V}, R_L = 100\Omega)$ (Fig.20)	T_{ON}	4N35 4N36 4N37		2	10	μs

**4N25
4N37**

**4N26
H11A1**

**4N27
H11A2**

**4N28
H11A3**

**4N35
H11A4**

**4N36
H11A5**

TRANSFER CHARACTERISTICS ($T_A = 25^\circ\text{C}$ Unless otherwise specified.) (Continued)

AC Characteristic	Test Conditions	Symbol	Device	Min	Typ*	Max	Unit
Turn-off Time	($I_F = 10 \text{ mA}$, $V_{CC} = 10 \text{ V}$, $R_L = 100\Omega$) (Fig.20)	T_{OFF}	4N25 4N26 4N27 4N28 H11A1 H11A2 H11A3 H11A4 H11A5		2		μs
	($I_C = 2 \text{ mA}$, $V_{CC} = 10 \text{ V}$, $R_L = 100\Omega$) (Fig.20)		4N35 4N36 4N37		2	10	

* Typical values at $T_A = 25^\circ\text{C}$

**4N25
4N37**

**4N26
H11A1**

**4N27
H11A2**

**4N28
H11A3**

**4N35
H11A4**

**4N36
H11A5**

TYPICAL PERFORMANCE CURVES

**Fig. 1 LED Forward Voltage vs. Forward Current
(Black Package)**



**Fig. 2 LED Forward Voltage vs. Forward Current
(White Package)**



**Fig.3 Normalized CTR vs. Forward Current
(Black Package)**



**Fig.4 Normalized CTR vs. Forward Current
(White Package)**



**Fig. 5 Normalized CTR vs. Ambient Temperature
(Black Package)**



**Fig. 6 Normalized CTR vs. Ambient Temperature
(White Package)**



**4N25
4N37**

**4N26
H11A1**

**4N27
H11A2**

**4N28
H11A3**

**4N35
H11A4**

**4N36
H11A5**

**Fig. 7 CTR vs. RBE (Unsaturated)
(Black Package)**



**Fig. 8 CTR vs. RBE (Unsaturated)
(White Package)**



**Fig. 9 CTR vs. RBE (Saturated)
(Black Package)**



**Fig. 10 CTR vs. RBE (Saturated)
(White Package)**



**Fig. 11 Collector-Emitter Saturation Voltage vs. Collector Current
(Black Package)**



**Fig. 12 Collector-Emitter Saturation Voltage vs. Collector Current
(White Package)**



**4N25
4N37**

**4N26
H11A1**

**4N27
H11A2**

**4N28
H11A3**

**4N35
H11A4**

**4N36
H11A5**

**Fig. 13 Switching Speed vs. Load Resistor
(Black Package)**

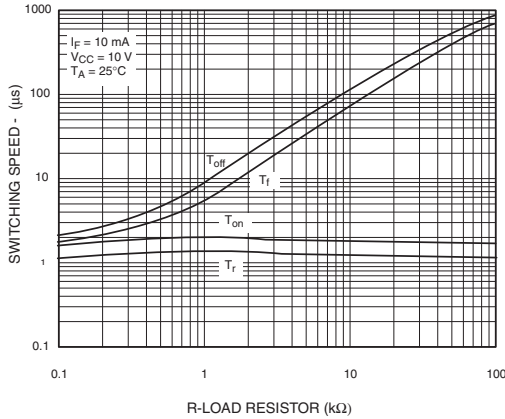

**Fig. 14 Switching Speed vs. Load Resistor
(White Package)**

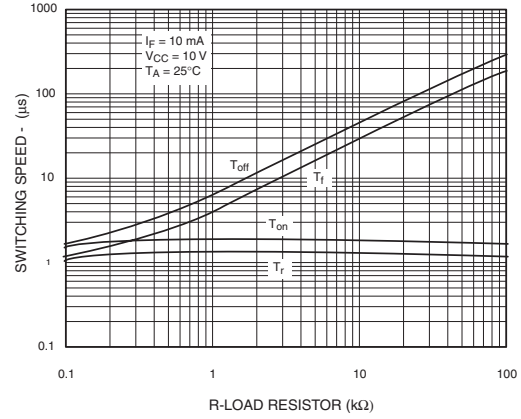

**Fig. 15 Normalized t_{on} vs. R_{BE}
(Black Package)**

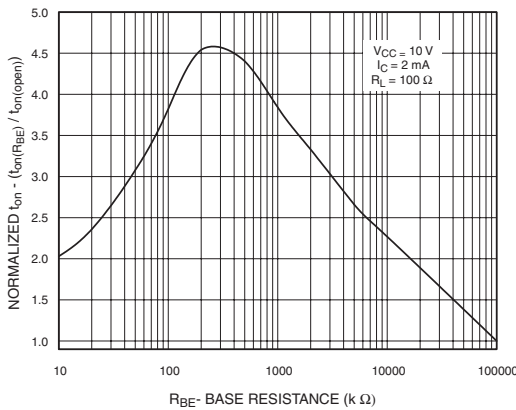

**Fig. 16 Normalized t_{on} vs. R_{BE}
(White Package)**

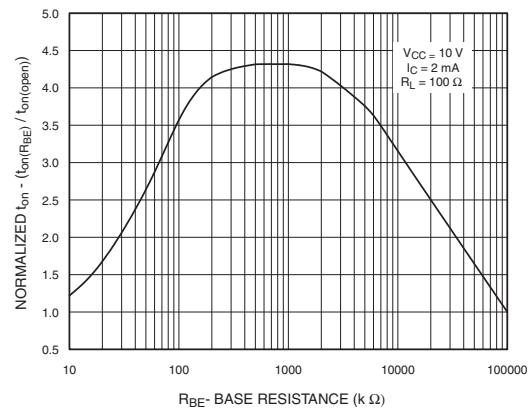

**Fig. 17 Normalized t_{off} vs. R_{BE}
(Black Package)**

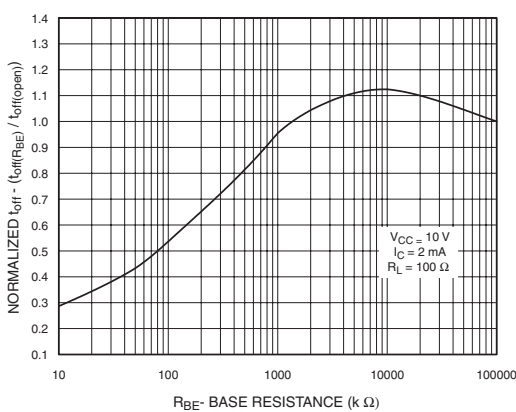

**Fig. 18 Normalized t_{off} vs. R_{BE}
(White Package)**

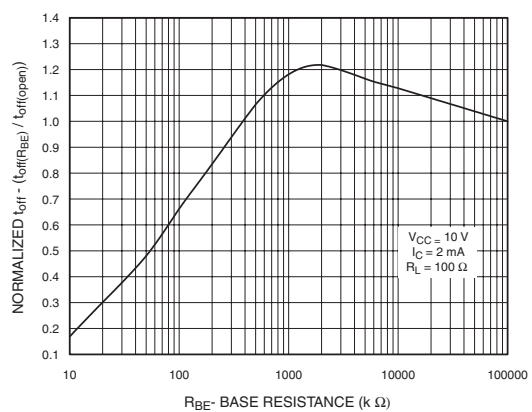

4N25
4N37

4N26
H11A1

4N27
H11A2

4N28
H11A3

4N35
H11A4

4N36
H11A5

Fig. 19 Dark Current vs. Ambient Temperature

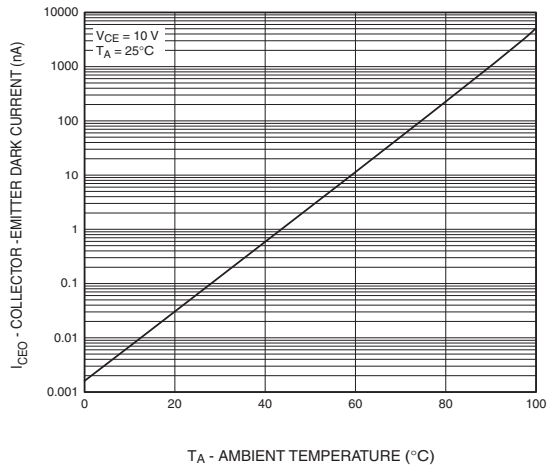

Figure 20. Switching Time Test Circuit and Waveforms

**4N25
4N37**

**4N26
H11A1**

**4N27
H11A2**

**4N28
H11A3**

**4N35
H11A4**

**4N36
H11A5**

Black Package (No -M Suffix)

Package Dimensions (Through Hole)



Package Dimensions (Surface Mount)

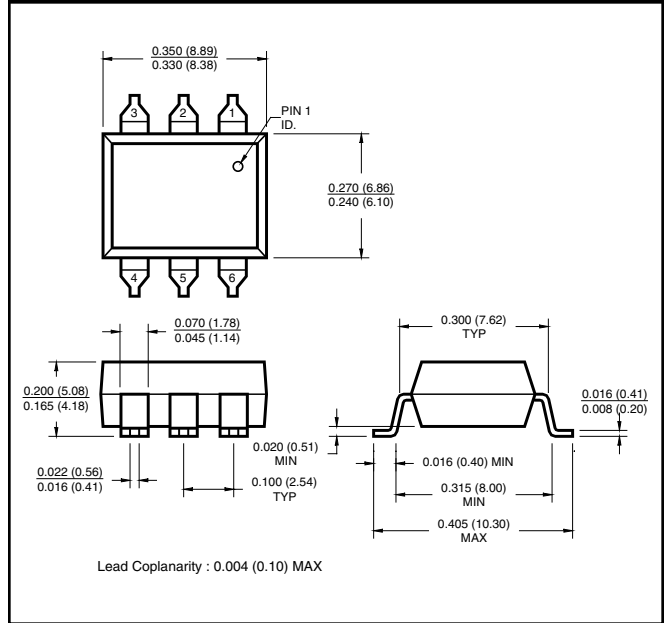

Package Dimensions (0.4" Lead Spacing)



**Recommended Pad Layout for
Surface Mount Leadform**

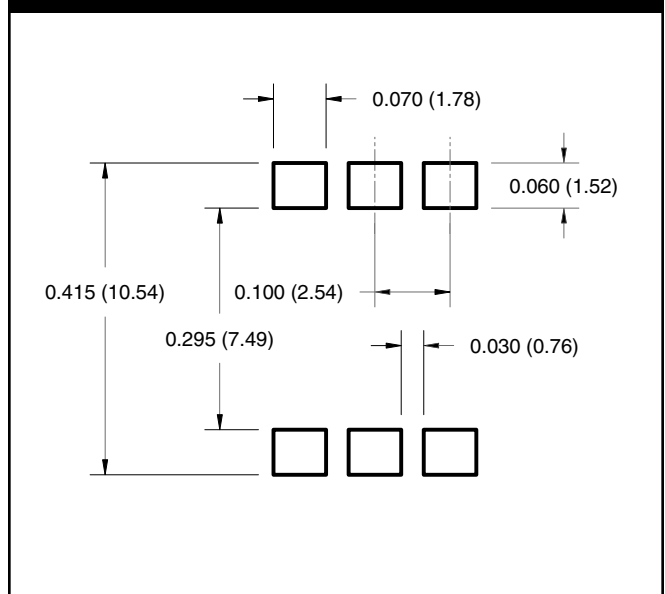

NOTE

All dimensions are in inches (millimeters)

**4N25
4N37**

**4N26
H11A1**

**4N27
H11A2**

**4N28
H11A3**

**4N35
H11A4**

**4N36
H11A5**

White Package (-M Suffix)

Package Dimensions (Through Hole)



Package Dimensions (Surface Mount)



Package Dimensions (0.4" Lead Spacing)



**Recommended Pad Layout for
Surface Mount Leadform**

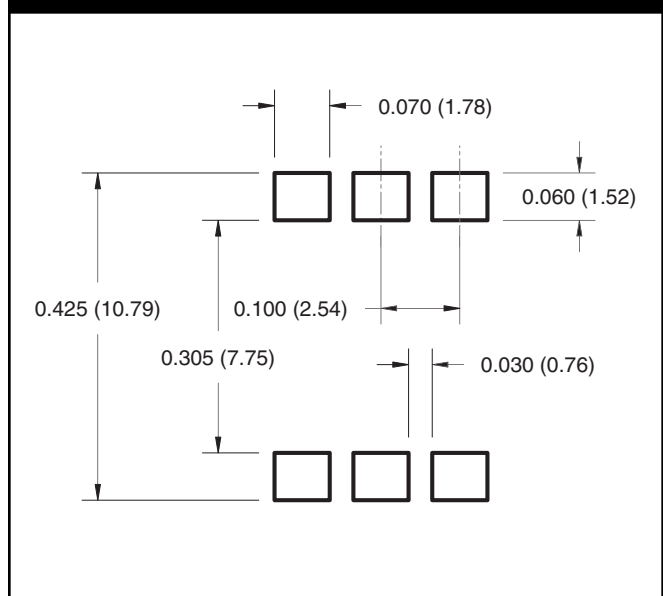

NOTE

All dimensions are in inches (millimeters)

**4N25
4N37**

**4N26
H11A1**

**4N27
H11A2**

**4N28
H11A3**

**4N35
H11A4**

**4N36
H11A5**

ORDERING INFORMATION

Order Entry Identifier		
Black Package (No Suffix)	White Package (-M Suffix)	Option
.S	S	Surface Mount Lead Bend
.SD	SR2	Surface Mount; Tape and reel
.W	T	0.4" Lead Spacing
.300	V	VDE 0884
.300W	TV	VDE 0884, 0.4" Lead Spacing
.3S	SV	VDE 0884, Surface Mount
.3SD	SR2V	VDE 0884, Surface Mount, Tape & Reel

MARKING INFORMATION



Black Package, No Suffix



White Package, -M Suffix

Definitions	
1	Fairchild logo
2	Device number
3	VDE mark (Note: Only appears on parts ordered with VDE option – See order entry table)
4	One or two digit year code • Two digits for black package parts, e.g., '03' • One digit for white package parts, e.g., '3'
5	Two digit work week ranging from '01' to '53'
6	Assembly package code

*Note – Parts built in the white package (M suffix) that do not have the 'V' option (see definition 3 above) that are marked with date code '325' or earlier are marked in the portrait format.

**4N25
4N37**

**4N26
H11A1**

**4N27
H11A2**

**4N28
H11A3**

**4N35
H11A4**

**4N36
H11A5**

QT Carrier Tape Specifications (Black Package, No Suffix)



QT Carrier Tape Specifications (White Package, -M Suffix)



**4N25
4N37**

**4N26
H11A1**

**4N27
H11A2**

**4N28
H11A3**

**4N35
H11A4**

**4N36
H11A5**

Reflow Profile (White Package, -M Suffix)



- Peak reflow temperature: 245°C (package surface temperature)
- Time of temperature higher than 183°C for 120-180 seconds
- One time soldering reflow is recommended

Reflow Profile (Black Package, No Suffix)



- Peak reflow temperature: 225°C (package surface temperature)
- Time of temperature higher than 183°C for 60-150 seconds
- One time soldering reflow is recommended

**4N25
4N37**

**4N26
H11A1**

**4N27
H11A2**

**4N28
H11A3**

**4N35
H11A4**

**4N36
H11A5**

DISCLAIMER

FAIRCHILD SEMICONDUCTOR RESERVES THE RIGHT TO MAKE CHANGES WITHOUT FURTHER NOTICE TO ANY PRODUCTS HEREIN TO IMPROVE RELIABILITY, FUNCTION OR DESIGN. FAIRCHILD DOES NOT ASSUME ANY LIABILITY ARISING OUT OF THE APPLICATION OR USE OF ANY PRODUCT OR CIRCUIT DESCRIBED HEREIN; NEITHER DOES IT CONVEY ANY LICENSE UNDER ITS PATENT RIGHTS, NOR THE RIGHTS OF OTHERS.

LIFE SUPPORT POLICY

FAIRCHILD'S PRODUCTS ARE NOT AUTHORIZED FOR USE AS CRITICAL COMPONENTS IN LIFE SUPPORT DEVICES OR SYSTEMS WITHOUT THE EXPRESS WRITTEN APPROVAL OF THE PRESIDENT OF FAIRCHILD SEMICONDUCTOR CORPORATION. As used herein:

1. Life support devices or systems are devices or systems which, (a) are intended for surgical implant into the body, or (b) support or sustain life, and (c) whose failure to perform when properly used in accordance with instructions for use provided in the labeling, can be reasonably expected to result in a significant injury of the user.
2. A critical component in any component of a life support device or system whose failure to perform can be reasonably expected to cause the failure of the life support device or system, or to affect its safety or effectiveness.