

## 阅读申明

- 1.本站收集的数据手册和产品资料都来自互联网，版权归原作者所有。如读者和版权方有任何异议请及时告之，我们将妥善解决。
- 2.本站提供的中文数据手册是英文数据手册的中文翻译，其目的是协助用户阅读，该译文无法自动跟随原稿更新，同时也可能存在翻译上的不当。建议读者以英文原稿为参考以便获得更精准的信息。
- 3.本站提供的产品资料，来自厂商的技术支持或者使用者的心得体会等，其内容可能存在描述上的差异，建议读者做出适当判断。
- 4.如需与我们联系，请发邮件到marketing@iczoom.com，主题请标有“数据手册”字样。

## Read Statement

1. The datasheets and other product information on the site are all from network reference or other public materials, and the copyright belongs to the original author and original published source. If readers and copyright owners have any objections, please contact us and we will deal with it in a timely manner.
2. The Chinese datasheets provided on the website is a Chinese translation of the English datasheets. Its purpose is for reader's learning exchange only and do not involve commercial purposes. The translation cannot be automatically updated with the original manuscript, and there may also be improper translations. Readers are advised to use the English manuscript as a reference for more accurate information.
3. All product information provided on the website refer to solutions from manufacturers' technical support or users the contents may have differences in description, and readers are advised to take the original article as the standard.
4. If you have any questions, please contact us at marketing@iczoom.com and mark the subject with "Datasheets" .

# DDR SDRAM UDIMM

MT8VDDT3264A – 256MB

MT8VDDT6464A – 512MB

For component data sheets, refer to Micron's Web site: [www.micron.com](http://www.micron.com)

## Features

- 184-pin, unbuffered dual in-line memory module (UDIMM)
- Fast data transfer rates: PC2100, PC2700, or PC3200
- 256MB (32 Meg x 64), and 512MB (64 Meg x 64)
- VDD = VDDQ = +2.5V (-40B: VDD = VDDQ)
- VDDSPD = +2.3V to +3.6V
- 2.5V I/O (SSTL\_2-compatible)
- Internal pipelined double data rate (DDR) 2n-prefetch architecture
- Bidirectional data strobe (DQS) transmitted/received with data—that is, source-synchronous data capture
- Differential clock inputs (CK and CK#)
- Multiple internal device banks for concurrent operation
- Single rank
- Selectable burst lengths (BL): 2, 4, or 8
- Auto precharge option
- Auto refresh and self refresh modes: 7.8125µs maximum average periodic refresh interval
- Serial presence-detect (SPD) with EEPROM
- Selectable CAS latency (CL) for maximum compatibility
- Gold edge contacts

## 184-Pin UDIMM (MO-206) Figures

Figure 1: Standard Layout

PCB height: 31.75mm (1.25in)

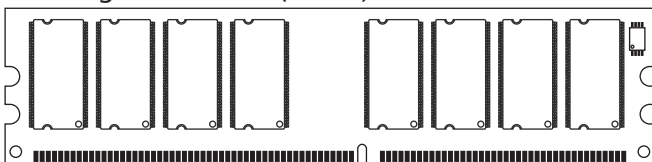

Figure 2: Alternative Layout

PCB height: 31.75mm (1.25in)

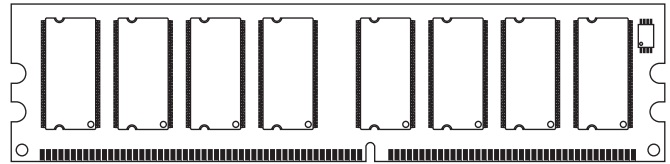
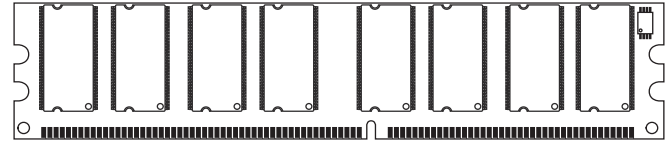

Figure 3: Reduced-Height Layout

PCB height: 28.58mm (1.125in)



## Options

- Operating temperature<sup>1</sup>
  - Commercial (0°C ≤ T<sub>A</sub> ≤ +70°C) None
  - Industrial (-40°C ≤ T<sub>A</sub> ≤ +85°C) I
- Package
  - 184-pin DIMM (standard) G
  - 184-pin DIMM (Pb-free) Y
- Memory clock, speed, CAS latency
  - 5.0ns (200 MHz), 400 MT/s, CL = 3 -40B
  - 6.0ns (167 MHz), 333 MT/s, CL = 2.5 -335
  - 7.5ns (133 MHz), 266 MT/s, CL = 2<sup>2</sup> -262
  - 7.5ns (133 MHz), 266 MT/s, CL = 2<sup>2</sup> -26A
  - 7.5ns (133 MHz), 266 MT/s, CL = 2.5<sup>2</sup> -265

## Marking

- Notes: 1. Contact Micron for industrial temperature module offerings.  
2. Not recommended for new designs.



**Table 1: Key Timing Parameters**

Speed Grade	Industry Nomenclature	Data Rate (MT/s)			<sup>t</sup> RCD (ns)	<sup>t</sup> RP (ns)	<sup>t</sup> RC (ns)	Notes
		CL = 3	CL = 2.5	CL = 2				
-40B	PC3200	400	333	266	15	15	55	
-335	PC2700	-	333	266	18	18	60	1
-262	PC2100	-	266	266	15	15	60	
-26A	PC2100	-	266	266	20	20	65	
-265	PC2100	-	266	200	20	20	65	

Notes: 1. The values of <sup>t</sup>RCD and <sup>t</sup>RP for -335 modules show 18ns to align with industry specifications; actual DDR SDRAM device specifications are 15ns.

**Table 2: Addressing**

Parameter	256MB	512MB
Refresh count	8K	8K
Row address	8K (A0-A12)	8K (A0-A12)
Device bank address	4 (BA0, BA1)	4 (BA0, BA1)
Device configuration	256Mb (32 Meg x 8)	512Mb (64 Meg x 8)
Column address	1K (A0-A9)	2K (A0-A9, A11)
Module rank address	1 (S0#)	1 (S0#)

**Table 3: Part Numbers and Timing Parameters – 256MB**

Base device: MT46V32M8,<sup>1</sup> 256Mb DDR SDRAM

Part Number <sup>2</sup>	Module Density	Configuration	Module Bandwidth	Memory Clock/ Data Rate	Clock Cycles (CL- <sup>t</sup> RCD- <sup>t</sup> RP)
MT8VDDT3264AG-40B__	256MB	32 Meg x 64	3.2 GB/s	5.0ns/400 MT/s	3-3-3
MT8VDDT3264AY-40B__	256MB	32 Meg x 64	3.2 GB/s	5.0ns/400 MT/s	3-3-3
MT8VDDT3264AG-335__	256MB	32 Meg x 64	2.7 GB/s	6.0ns/333 MT/s	2.5-3-3
MT8VDDT3264AY-335__	256MB	32 Meg x 64	2.7 GB/s	6.0ns/333 MT/s	2.5-3-3
MT8VDDT3264AG-262__	256MB	32 Meg x 64	2.1 GB/s	7.5ns/266 MT/s	2-2-2
MT8VDDT3264AG-26A__	256MB	32 Meg x 64	2.1 GB/s	7.5ns/266 MT/s	2-3-3
MT8VDDT3264AG-265__	256MB	32 Meg x 64	2.1 GB/s	7.5ns/266 MT/s	2.5-3-3
MT8VDDT3264AY-265__	256MB	32 Meg x 64	2.1 GB/s	7.5ns/266 MT/s	2.5-3-3

**Table 4: Part Numbers and Timing Parameters – 512MB**

Base device: MT46V64M8,<sup>1</sup> 512Mb DDR SDRAM

Part Number <sup>2</sup>	Module Density	Configuration	Module Bandwidth	Memory Clock/ Data Rate	Clock Cycles (CL- <sup>t</sup> RCD- <sup>t</sup> RP)
MT8VDDT6464AG-40B__	512MB	64 Meg x 64	3.2 GB/s	5.0ns/400 MT/s	3-3-3
MT8VDDT6464AY-40B__	512MB	64 Meg x 64	3.2 GB/s	5.0ns/400 MT/s	3-3-3
MT8VDDT6464AG-335__	512MB	64 Meg x 64	2.7 GB/s	6.0ns/333 MT/s	2.5-3-3
MT8VDDT6464AY-335__	512MB	64 Meg x 64	2.7 GB/s	6.0ns/333 MT/s	2.5-3-3
MT8VDDT6464AG-262__	512MB	64 Meg x 64	2.1 GB/s	7.5ns/266 MT/s	2-2-2
MT8VDDT6464AG-26A__	512MB	64 Meg x 64	2.1 GB/s	7.5ns/266 MT/s	2-3-3
MT8VDDT6464AG-265__	512MB	64 Meg x 64	2.1 GB/s	7.5ns/266 MT/s	2.5-3-3
MT8VDDT6464AY-265__	512MB	64 Meg x 64	2.1 GB/s	7.5ns/266 MT/s	2.5-3-3

Notes: 1. Data sheets for the base devices can be found on Micron's Web site.  
 2. All part numbers end with a two-place code (not shown) that designates component and PCB revisions. Consult factory for current revision codes. Example: MT8VDDT3264AY-335G6.



## Pin Assignments and Descriptions

Table 5: Pin Assignments

184-Pin DDR UDIMM Front								184-Pin DDR UDIMM Back							
Pin	Symbol	Pin	Symbol	Pin	Symbol	Pin	Symbol	Pin	Symbol	Pin	Symbol	Pin	Symbol		
1	VREF	24	DQ17	47	DNU	70	VDD	93	Vss	116	Vss	139	Vss	162	DQ47
2	DQ0	25	DQS2	48	A0	71	NC	94	DQ4	117	DQ21	140	DNU	163	NC
3	Vss	26	Vss	49	DNU	72	DQ48	95	DQ5	118	A11	141	A10	164	VDDQ
4	DQ1	27	A9	50	Vss	73	DQ49	96	VDDQ	119	DM2	142	DNU	165	DQ52
5	DQS0	28	DQ18	51	DNU	74	Vss	97	DM0	120	VDD	143	VDDQ	166	DQ53
6	DQ2	29	A7	52	BA1	75	CK2#	98	DQ6	121	DQ22	144	DNU	167	NC
7	VDD	30	VDDQ	53	DQ32	76	CK2	99	DQ7	122	A8	145	Vss	168	VDD
8	DQ3	31	DQ19	54	VDDQ	77	VDDQ	100	Vss	123	DQ23	146	DQ36	169	DM6
9	NC	32	A5	55	DQ33	78	DQS6	101	NC	124	Vss	147	DQ37	170	DQ54
10	NC	33	DQ24	56	DQS4	79	DQ50	102	NC	125	A6	148	VDD	171	DQ55
11	Vss	34	Vss	57	DQ34	80	DQ51	103	NC	126	DQ28	149	DM4	172	VDDQ
12	DQ8	35	DQ25	58	Vss	81	Vss	104	VDDQ	127	DQ29	150	DQ38	173	NC
13	DQ9	36	DQS3	59	BA0	82	NC	105	DQ12	128	VDDQ	151	DQ39	174	DQ60
14	DQS1	37	A4	60	DQ35	83	DQ56	106	DQ13	129	DM3	152	Vss	175	DQ61
15	VDDQ	38	VDD	61	DQ40	84	DQ57	107	DM1	130	A3	153	DQ44	176	Vss
16	CK1	39	DQ26	62	VDDQ	85	VDD	108	VDD	131	DQ30	154	RAS#	177	DM7
17	CK1#	40	DQ27	63	WE#	86	DQS7	109	DQ14	132	Vss	155	DQ45	178	DQ62
18	Vss	41	A2	64	DQ41	87	DQ58	110	DQ15	133	DQ31	156	VDDQ	179	DQ63
19	DQ10	42	Vss	65	CAS#	88	DQ59	111	NC	134	DNU	157	S0#	180	VDDQ
20	DQ11	43	A1	66	Vss	89	Vss	112	VDDQ	135	DNU	158	NC	181	SA0
21	CKE0	44	DNU	67	DQS5	90	NC	113	NC	136	VDDQ	159	DM5	182	SA1
22	VDDQ	45	DNU	68	DQ42	91	SDA	114	DQ20	137	CK0	160	Vss	183	SA2
23	DQ16	46	VDD	69	DQ43	92	SCL	115	A12	138	CK0#	161	DQ46	184	VDDSPD

Table 6: Pin Descriptions

Symbol	Type	Description
A0–A12	Input (SSTL_18)	<b>Address inputs:</b> Provide the row address for ACTIVE commands, and the column address and auto precharge bit (A10) for READ/WRITE commands, to select one location out of the memory array in the respective device bank. A10 sampled during a PRECHARGE command determines whether the PRECHARGE applies to one device bank (A10 LOW, device bank selected by BA0, BA1) or all device banks (A10 HIGH). The address inputs also provide the op-code during a MODE REGISTER SET command. BA0, BA1 define which mode register (mode register or extended mode register) is loaded during the LOAD MODE REGISTER command.
BA0, BA1	Input (SSTL_18)	<b>Bank address:</b> BA0, BA1 define to which device bank an ACTIVE, READ, WRITE, or PRECHARGE command is being applied.
CK0, CK0#, CK1, CK1#, CK2, CK2#	Input (SSTL_18)	<b>Clock:</b> CK and CK# are differential clock inputs. All address and control input signals are sampled on the crossing of the positive edge of CK and the negative edge of CK#. Output data (DQ and DQS) is referenced to the crossings of CK and CK#.
CKE0	Input (SSTL_18)	<b>Clock enable:</b> CKE (registered HIGH) activates and CKE (registered LOW) deactivates the internal clock, input buffers, and output drivers.
DM0–DM7	Input (SSTL_18)	<b>Input data mask:</b> DM is an input mask signal for write data. Input data is masked when DM is sampled HIGH, along with that input data, during a write access. DM is sampled on both edges of DQS. Although DM pins are input-only, the DM loading is designed to match that of DQ and DQS pins.
RAS#, CAS#, WE#	Input (SSTL_18)	<b>Command inputs:</b> RAS#, CAS#, and WE# (along with S#) define the command being entered.
S0#	Input (SSTL_18)	<b>Chip selects:</b> S# enables (registered LOW) and disables (registered HIGH) the command decoder.
SA0–SA2	Input (SSTL_18)	<b>Presence-detect address inputs:</b> These pins are used to configure the presence-detect device.
SCL	Input (SSTL_18)	<b>Serial clock for presence-detect:</b> SCL is used to synchronize the presence-detect data transfer to and from the module.
DQ0–DQ63	I/O (SSTL_18)	<b>Data input/output:</b> Data bus.
DQS0–DQS7	I/O (SSTL_18)	<b>Data strobe:</b> Output with read data, input with write data. DQS is edge-aligned with read data, center-aligned with write data. Used to capture data.
SDA	I/O (SSTL_18)	<b>Serial presence-detect data:</b> SDA is a bidirectional pin used to transfer addresses and data into and out of the presence-detect portion of the module.
VDD/VDDQ	Supply	<b>Power supply:</b> +2.5V ±0.2V (-40B: +2.6V ±0.1V)
VDDSPD	Supply	<b>Serial EEPROM positive power supply:</b> +2.3V to +3.6V.
VREF	Supply	SSTL_2 reference voltage (VDD/2).
VSS	Supply	<b>Ground.</b>
DNU	–	<b>Do not use:</b> These pins are not connected on these modules, but are assigned on other modules in this product family.
NC	–	<b>No connect:</b> These pins are not connected on the module.

## Functional Block Diagrams

Figure 4: Functional Block Diagram – Standard Layout

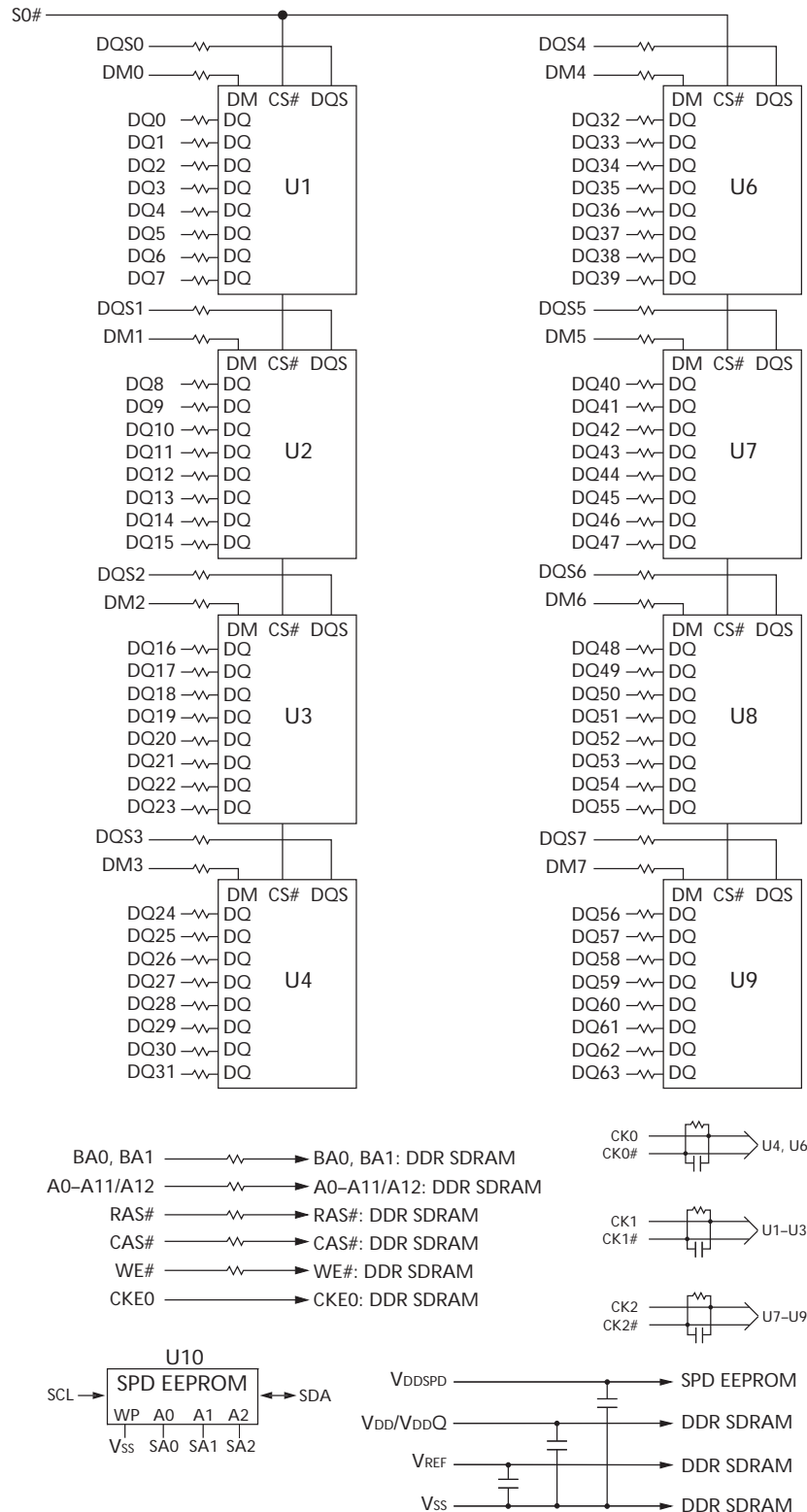
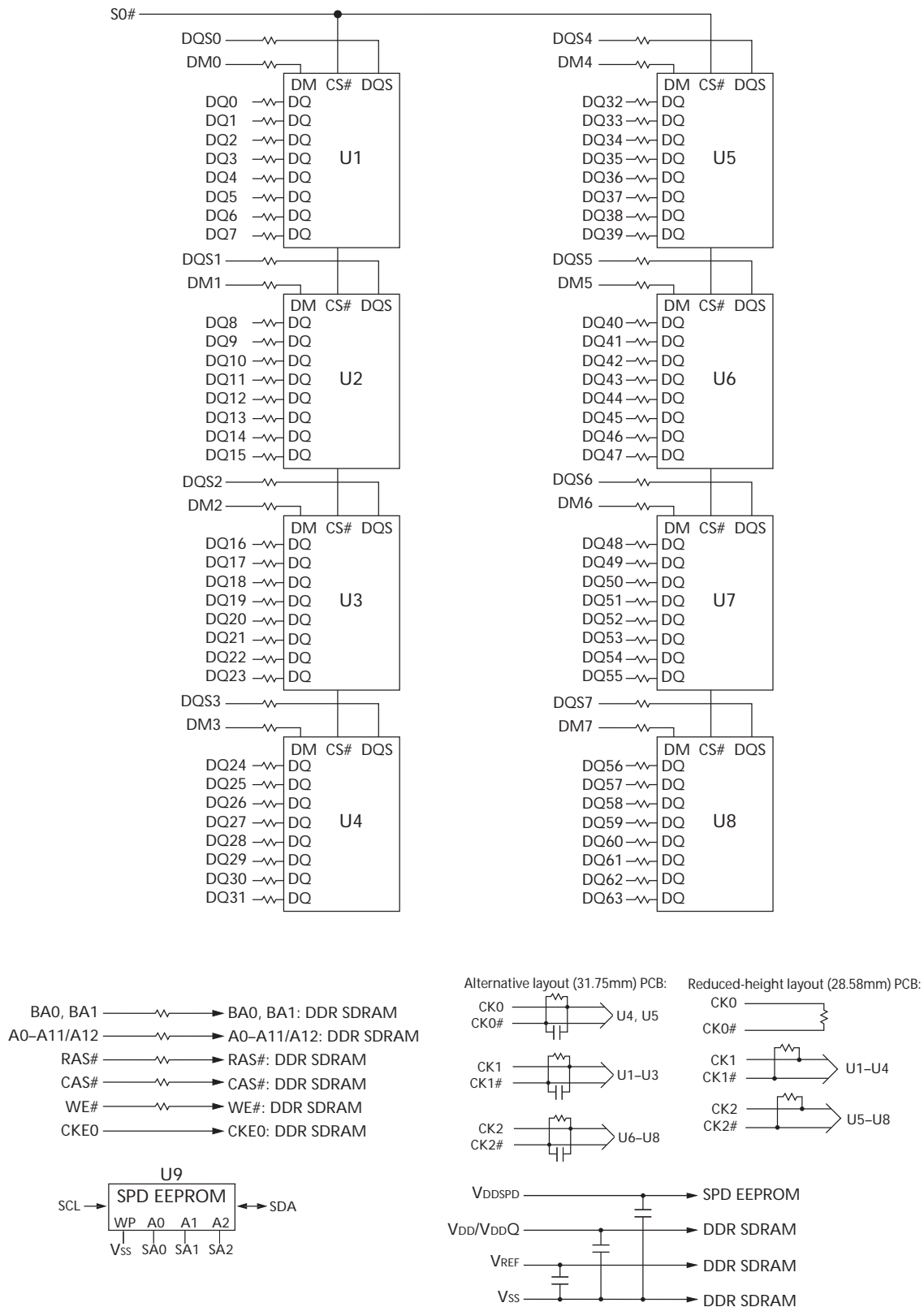

Figure 5: Functional Block Diagram – Alternative and Reduced-Height Layout



## General Description

The MT8VDDT3264A, and MT8VDDT6464A are high-speed, CMOS, dynamic random access, 256MB, and 512MB memory modules organized in a x64 configuration. These modules use DDR SDRAM devices with four internal banks.

DDR SDRAM modules use a double data rate architecture to achieve high-speed operation. The double data rate architecture is essentially a  $2n$ -prefetch architecture with an interface designed to transfer two data words per clock cycle at the I/O pins. A single read or write access for DDR SDRAM modules effectively consists of a single  $2n$ -bit-wide, one-clock-cycle data transfer at the internal DRAM core and two corresponding  $n$ -bit-wide, one-half-clock-cycle data transfers at the I/O pins.

A bidirectional data strobe (DQS) is transmitted externally, along with data, for use in data capture at the receiver. DQS is a strobe transmitted by the DDR SDRAM during READs and by the memory controller during WRITEs. DQS is edge-aligned with data for READs and center-aligned with data for WRITEs.

DDR SDRAM modules operate from differential clock inputs (CK and CK#); the crossing of CK going HIGH and CK# going LOW will be referred to as the positive edge of CK. Commands are registered at every positive edge of CK. Input data is registered on both edges of DQS, and output data is referenced to both edges of DQS, as well as to both edges of CK.

## Serial Presence-Detect Operation

DDR SDRAM modules incorporate serial presence-detect. The SPD data is stored in a 256-byte EEPROM. The first 128 bytes are programmed by Micron to identify the module type and various DDR SDRAM organizations and timing parameters. The remaining 128 bytes of storage are available for use by the customer. System READ/WRITE operations between the master (system logic) and the slave EEPROM device occur via a standard I<sup>2</sup>C bus using the DIMM's SCL (clock) and SDA (data) signals, together with SA[2:0], which provide eight unique DIMM/EEPROM addresses. Write protect (WP) is connected to VSS, permanently disabling hardware write protect.



## Electrical Specifications

Stresses greater than those listed in Table 7 may cause permanent damage to the module. This is a stress rating only, and functional operation of the module at these or any other conditions outside those indicated in each device's data sheet is not implied. Exposure to absolute maximum rating conditions for extended periods may adversely affect reliability.

**Table 7: Absolute Maximum Ratings**

Symbol	Parameter	Min	Max	Units	
VDD/VDDQ	VDD/VDDQ supply voltage relative to Vss	-1.0	+3.6	V	
VIN, VOUT	Voltage on any pin relative to Vss	-0.5	+3.2	V	
II	Input leakage current; Any input $0V \leq V_{IN} \leq V_{DD}$ ; VREF input $0V \leq V_{IN} \leq 1.35V$ (All other pins not under test = 0V)	Address inputs, RAS#, CAS#, WE#, BA, S#, CKE	-16	+16	$\mu A$
		CK0, CK0# (standard and alternative layouts)	-4	+4	
		CK1, CK1#, CK2, CK2# (standard and alternative layouts)	-6	+6	
		CK1, CK1#, CK2, CK2# (reduced-height layouts)	-8	+8	
		DM	-2	+2	
IOZ	Output leakage current; $0V \leq V_{OUT} \leq V_{DDQ}$ ; DQs are disabled	-5	+5	$\mu A$	
TA	DRAM ambient operating temperature <sup>1</sup>	Commercial	0	+70	°C
		Industrial	-40	+85	°C

Notes: 1. For further information, refer to technical note TN-00-08: "Thermal Applications," available on Micron's Web site.

## DRAM Operating Conditions

Recommended AC operating conditions are given in the DDR component data sheets. Component specifications are available on Micron's Web site. Module speed grades correlate with component speed grades, as shown in Table 8.

**Table 8: Module and Component Speed Grades**  
DDR components may exceed the listed module speed grades

Module Speed Grade	Component Speed Grade
-40B	-5B
-335	-6
-262	-75E
-26A	-75Z
-265	-75

## Design Considerations

### Simulations

Micron memory modules are designed to optimize signal integrity through carefully designed terminations, controlled board impedances, routing topologies, trace length matching, and decoupling. However, good signal integrity starts at the system level. Micron encourages designers to simulate the signal characteristics of the system's memory bus to ensure adequate signal integrity of the entire memory system.

### Power

Operating voltages are specified at the DRAM, not at the edge connector of the module. Designers must account for any system voltage drops at anticipated power levels to ensure the required supply voltage is maintained.

## IDD Specifications

**Table 9: IDD Specifications and Conditions – 256MB (Die Revision ‘K’)**

Values are shown for the MT46V32M8 DDR SDRAM only and are computed from values specified in the 256Mb (32 Meg x 8) component data sheet

Parameter/Condition	Symbol	-40B	-335	Units	
<b>Operating one bank active-precharge current:</b> $t_{RC} = t_{RC}(\text{MIN})$ ; $t_{CK} = t_{CK}(\text{MIN})$ ; DQ, DM, and DQS inputs changing once per clock cycle; Address and control inputs changing once every two clock cycles	IDD0	800	720	mA	
<b>Operating one bank active-read-precharge current:</b> BL = 2; $t_{RC} = t_{RC}(\text{MIN})$ ; $t_{CK} = t_{CK}(\text{MIN})$ ; $I_{OUT} = 0\text{mA}$ ; Address and control inputs changing once per clock cycle	IDD1	960	920	mA	
<b>Precharge power-down standby current:</b> All device banks idle; Power-down mode; $t_{CK} = t_{CK}(\text{MIN})$ ; CKE = LOW	IDD2P	32	32	mA	
<b>Idle standby current:</b> CS# = HIGH; All device banks idle; $t_{CK} = t_{CK}(\text{MIN})$ ; CKE = HIGH; Address and other control inputs changing once per clock cycle; VIN = VREF for DQ, DM, and DQS	IDD2F	400	400	mA	
<b>Active power-down standby current:</b> One device bank active; Power-down mode; $t_{CK} = t_{CK}(\text{MIN})$ ; CKE = LOW	IDD3P	280	240	mA	
<b>Active standby current:</b> CS# = HIGH; CKE = HIGH; One device bank active; $t_{RC} = t_{RAS}(\text{MAX})$ ; $t_{CK} = t_{CK}(\text{MIN})$ ; DQ, DM, and DQS inputs changing twice per clock cycle; Address and other control inputs changing once per clock cycle	IDD3N	480	440	mA	
<b>Operating burst read current:</b> BL = 2; Continuous burst reads; One device bank active; Address and control inputs changing once per clock cycle; $t_{CK} = t_{CK}(\text{MIN})$ ; $I_{OUT} = 0\text{mA}$	IDD4R	1,440	1,280	mA	
<b>Operating burst write current:</b> BL = 2; Continuous burst writes; One device bank active; Address and control inputs changing once per clock cycle; $t_{CK} = t_{CK}(\text{MIN})$ ; DQ, DM, and DQS inputs changing twice per clock cycle	IDD4W	1,440	1,280	mA	
<b>Auto refresh current</b>	$t_{REFC} = t_{RC}(\text{MIN})$	IDD5	1,280	1,280	mA
	$t_{REFC} = 7.8125\mu\text{s}$	IDD5A	48	48	mA
<b>Self refresh current:</b> CKE $\leq 0.2\text{V}$	IDD6	32	32	mA	
<b>Operating bank interleave read current:</b> Four device bank interleaving reads; BL = 4 with auto precharge; $t_{RC} = t_{RC}(\text{MIN})$ ; $t_{CK} = t_{CK}(\text{MIN})$ ; Address and control inputs change only during active READ or WRITE commands	IDD7	2,320	2,160	mA	



**Table 10: IDD Specifications and Conditions – 256MB (All Other Die Revisions)**

Values are shown for the MT46V32M8 DDR SDRAM only and are computed from values specified in the 256Mb (32 Meg x 8) component data sheet

Parameter/Condition	Symbol	-40B	-335	-262	-26A/ -265	Units	
<b>Operating one bank active-precharge current:</b> $t_{RC} = t_{RC}(\text{MIN})$ ; $t_{CK} = t_{CK}(\text{MIN})$ ; DQ, DM, and DQS inputs changing once per clock cycle; Address and control inputs changing once every two clock cycles	IDD0	1,080	1,000	1,000	960	mA	
<b>Operating one bank active-read-precharge current:</b> BL = 4; $t_{RC} = t_{RC}(\text{MIN})$ ; $t_{CK} = t_{CK}(\text{MIN})$ ; I <sub>OUT</sub> = 0mA; Address and control inputs changing once per clock cycle	IDD1	1,360	1,360	1,280	1,160	mA	
<b>Precharge power-down standby current:</b> All device banks idle; Power-down mode; $t_{CK} = t_{CK}(\text{MIN})$ ; CKE = LOW	IDD2P	32	32	32	32	mA	
<b>Idle standby current:</b> CS# = HIGH; All device banks idle; $t_{CK} = t_{CK}(\text{MIN})$ ; CKE = HIGH; Address and other control inputs changing once per clock cycle; V <sub>IN</sub> = V <sub>REF</sub> for DQ, DM, and DQS	IDD2F	480	400	360	360	mA	
<b>Active power-down standby current:</b> One device bank active; Power-down mode; $t_{CK} = t_{CK}(\text{MIN})$ ; CKE = LOW	IDD3P	320	240	200	200/ 240	mA	
<b>Active standby current:</b> CS# = HIGH; CKE = HIGH; One device bank active; $t_{RC} = t_{RAS}(\text{MAX})$ ; $t_{CK} = t_{CK}(\text{MIN})$ ; DQ, DM, and DQS inputs changing twice per clock cycle; Address and other control inputs changing once per clock cycle	IDD3N	560	480	400	400	mA	
<b>Operating burst read current:</b> BL = 2; Continuous burst reads; One device bank active; Address and control inputs changing once per clock cycle; $t_{CK} = t_{CK}(\text{MIN})$ ; I <sub>OUT</sub> = 0mA	IDD4R	1,600	1,400	1,200	1,200	mA	
<b>Operating burst write current:</b> BL = 2; Continuous burst writes; One device bank active; Address and control inputs changing once per clock cycle; $t_{CK} = t_{CK}(\text{MIN})$ ; DQ, DM, and DQS inputs changing twice per clock cycle	IDD4W	1,560	1,400	1,200	1,200	mA	
<b>Auto refresh current</b>	$t_{REFC} = t_{RC}(\text{MIN})$	IDD5	2,080	2,040	1,880	1,880/ 1,960	mA
	$t_{REFC} = 7.8125\mu\text{s}$	IDD5A	48	48	48	48	mA
<b>Self refresh current:</b> CKE ≤ 0.2V	IDD6	32	32	32	32	mA	
<b>Operating bank interleave read current:</b> Four device bank interleaving reads; BL = 4 with auto precharge; $t_{RC} = t_{RC}(\text{MIN})$ ; $t_{CK} = t_{CK}(\text{MIN})$ ; Address and control inputs change only during active READ or WRITE commands	IDD7	3,760	3,280	2,800	2,800/ 2,920	mA	

**Table 11: IDD Specifications and Conditions – 512MB**

Values are shown for the MT46V64M8 DDR SDRAM only and are computed from values specified in the 512Mb (64 Meg x 8) component data sheet

Parameter/Condition	Symbol	-40B	-335	-262	-26A/ -265	Units	
<b>Operating one bank active-precharge current:</b> $t_{RC} = t_{RC}(\text{MIN})$ ; $t_{CK} = t_{CK}(\text{MIN})$ ; DQ, DM, and DQS inputs changing once per clock cycle; Address and control inputs changing once every two clock cycles	IDD0	1,240	1,040	1,040	920	mA	
<b>Operating one bank active-read-precharge current:</b> Active-read precharge; BL = 4; $t_{RC} = t_{RC}(\text{MIN})$ ; $t_{CK} = t_{CK}(\text{MIN})$ ; I <sub>OUT</sub> = 0mA; Address and control inputs changing once per clock cycle	IDD1	1,480	1,280	1,280	1,160	mA	
<b>Precharge power-down standby current:</b> All device banks idle; Power-down mode; $t_{CK} = t_{CK}(\text{MIN})$ ; CKE = LOW	IDD2P	40	40	40	40	mA	
<b>Idle standby current:</b> CS# = HIGH; All device banks idle; $t_{CK} = t_{CK}(\text{MIN})$ ; CKE = HIGH; Address and other control inputs changing once per clock cycle; V <sub>IN</sub> = V <sub>REF</sub> for DQ, DM, and DQS	IDD2F	440	360	360	320	mA	
<b>Active power-down standby current:</b> One device bank active; Power-down mode; $t_{CK} = t_{CK}(\text{MIN})$ ; CKE = LOW	IDD3P	360	280	280	240	mA	
<b>Active standby current:</b> CS# = HIGH; CKE = HIGH; One device bank active; $t_{RC} = t_{RAS}(\text{MAX})$ ; $t_{CK} = t_{CK}(\text{MIN})$ ; DQ, DM, and DQS inputs changing twice per clock cycle; Address and other control inputs changing once per clock cycle	IDD3N	480	400	400	360	mA	
<b>Operating burst read current:</b> BL = 2; Continuous burst reads; One device bank active; Address and control inputs changing once per clock cycle; $t_{CK} = t_{CK}(\text{MIN})$ ; I <sub>OUT</sub> = 0mA	IDD4R	1,520	1,320	1,320	1,160	mA	
<b>Operating burst write current:</b> BL = 2; Continuous burst writes; One device bank active; Address and control inputs changing once per clock cycle; $t_{CK} = t_{CK}(\text{MIN})$ ; DQ, DM, and DQS inputs changing twice per clock cycle	IDD4W	1,560	1,400	1,240	1,080	mA	
<b>Auto refresh current</b>	$t_{REFC} = t_{RC}(\text{MIN})$	IDD5	2,760	2,320	2,320	2,240	mA
	$t_{REFC} = 7.8125\mu\text{s}$	IDD5A	88	80	80	80	mA
<b>Self refresh current:</b> CKE ≤ 0.2V	IDD6	40	40	40	40	mA	
<b>Operating bank interleave read current:</b> Four device bank interleaving reads; BL = 4 with auto precharge; $t_{RC} = t_{RC}(\text{MIN})$ ; $t_{CK} = t_{CK}(\text{MIN})$ ; Address and control inputs change only during active READ or WRITE commands	IDD7	3,600	3,240	3,200	2,800	mA	

## Serial Presence-Detect

**Table 12: Serial Presence-Detect EEPROM DC Operating Conditions**

Parameter/Condition	Symbol	Min	Max	Units
Supply voltage	V <sub>DDSPD</sub>	2.3	3.6	V
Input high voltage: Logic 1; All inputs	V <sub>IH</sub>	V <sub>DDSPD</sub> × 0.7	V <sub>DDSPD</sub> + 0.5	V
Input low voltage: Logic 0; All inputs	V <sub>IL</sub>	-1.0	V <sub>DDSPD</sub> × 0.3	V
Output low voltage: I <sub>OUT</sub> = 3mA	V <sub>OL</sub>	-	0.4	V
Input leakage current: V <sub>IN</sub> = GND to V <sub>DD</sub>	I <sub>LI</sub>	-	10	μA
Output leakage current: V <sub>OUT</sub> = GND to V <sub>DD</sub>	I <sub>LO</sub>	-	10	μA
Standby current: SCL = SDA = V <sub>DD</sub> - 0.3V; All other inputs = V <sub>SS</sub> or V <sub>DD</sub>	I <sub>SB</sub>	-	30	μA
Power supply current: SCL clock frequency = 100 kHz	I <sub>CC</sub>	-	2.0	mA

**Table 13: Serial Presence-Detect EEPROM AC Operating Conditions**

Parameter/Condition	Symbol	Min	Max	Units	Notes
SCL LOW to SDA data-out valid	<sup>t</sup> AA	0.2	0.9	μs	1
Time the bus must be free before a new transition can start	<sup>t</sup> BUF	1.3	-	μs	
Data-out hold time	<sup>t</sup> DH	200	-	ns	
Clock/data fall time	<sup>t</sup> F	-	300	ns	2
Clock/data rise time	<sup>t</sup> R	-	300	ns	2
Data-in hold time	<sup>t</sup> HD:DAT	0	-	μs	
Start condition hold time	<sup>t</sup> HD:STA	0.6	-	μs	
Clock HIGH period	<sup>t</sup> HIGH	0.6	-	μs	
Noise suppression time constant at SCL, SDA inputs	<sup>t</sup> I	-	50	ns	
Clock LOW period	<sup>t</sup> LOW	1.3	-	μs	
SCL clock frequency	<sup>f</sup> SCL	-	400	kHz	
Data-in setup time	<sup>t</sup> SU:DAT	100	-	ns	
Start condition setup time	<sup>t</sup> SU:STA	0.6	-	μs	3
Stop condition setup time	<sup>t</sup> SU:STO	0.6	-	μs	
WRITE cycle time	<sup>t</sup> WRC	-	10	ms	4

- Notes:
1. To avoid spurious start and stop conditions, a minimum delay is placed between SCL = 1 and the falling or rising edge of SDA.
  2. This parameter is sampled.
  3. For a restart condition or following a WRITE cycle.
  4. The SPD EEPROM WRITE cycle time (<sup>t</sup>WRC) is the time from a valid stop condition of a write sequence to the end of the EEPROM internal ERASE/PROGRAM cycle. During the WRITE cycle, the EEPROM bus interface circuit is disabled, SDA remains HIGH due to pull-up resistance, and the EEPROM does not respond to its slave address.

## Serial Presence-Detect Data

For the latest serial presence-detect data, refer to Micron's SPD page:  
[www.micron.com/SPD](http://www.micron.com/SPD).

## Module Dimensions

Figure 6: 184-Pin UDIMM – Standard Layout

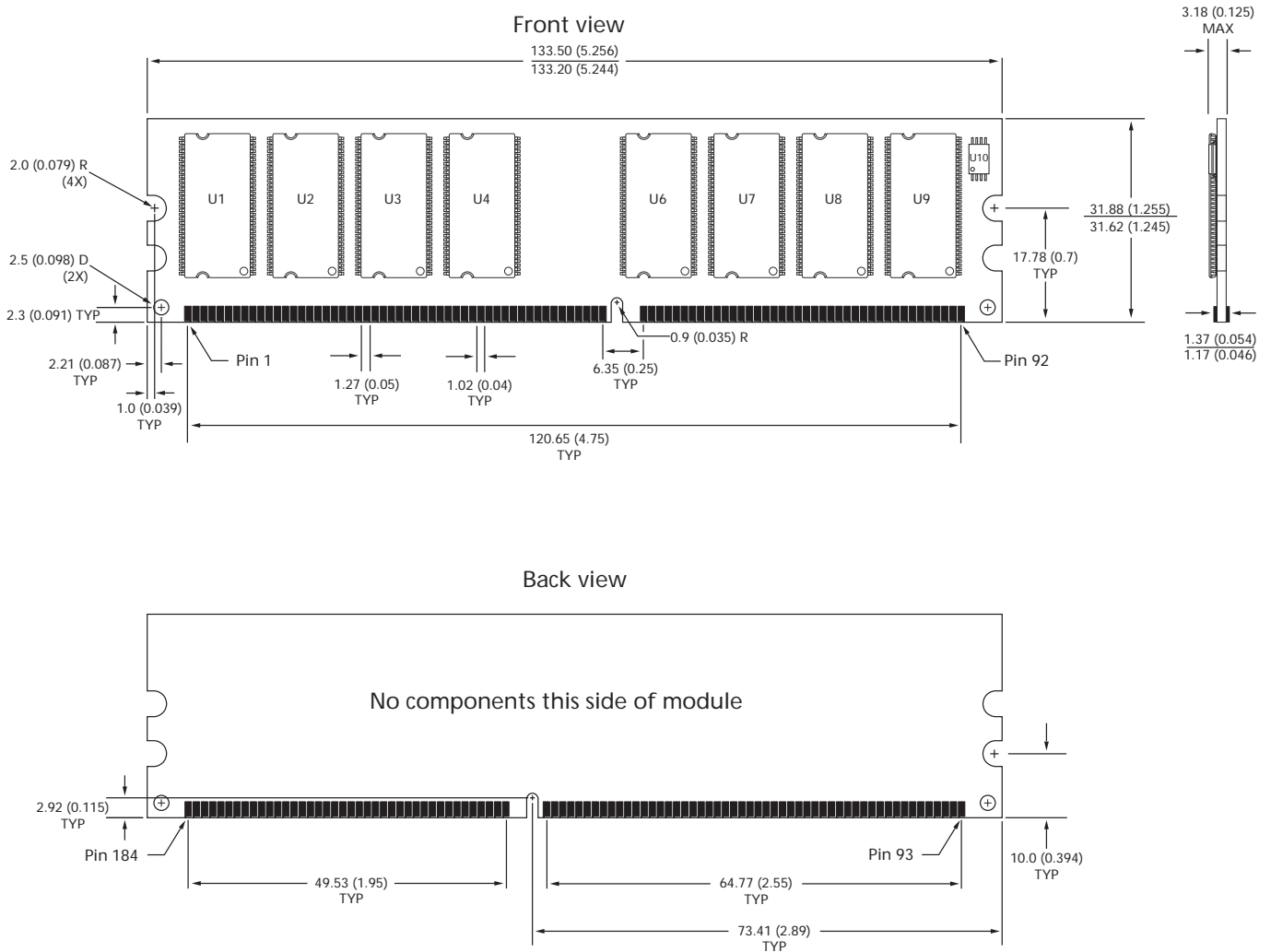

- Notes:
1. All dimensions are in millimeters (inches); MAX/MIN or typical (TYP) where noted.
  2. The dimensional diagram is for reference only. Refer to the JEDEC MO document for additional design dimensions.

Figure 7: 184-Pin UDIMM – Alternative and Reduced-Height Layout

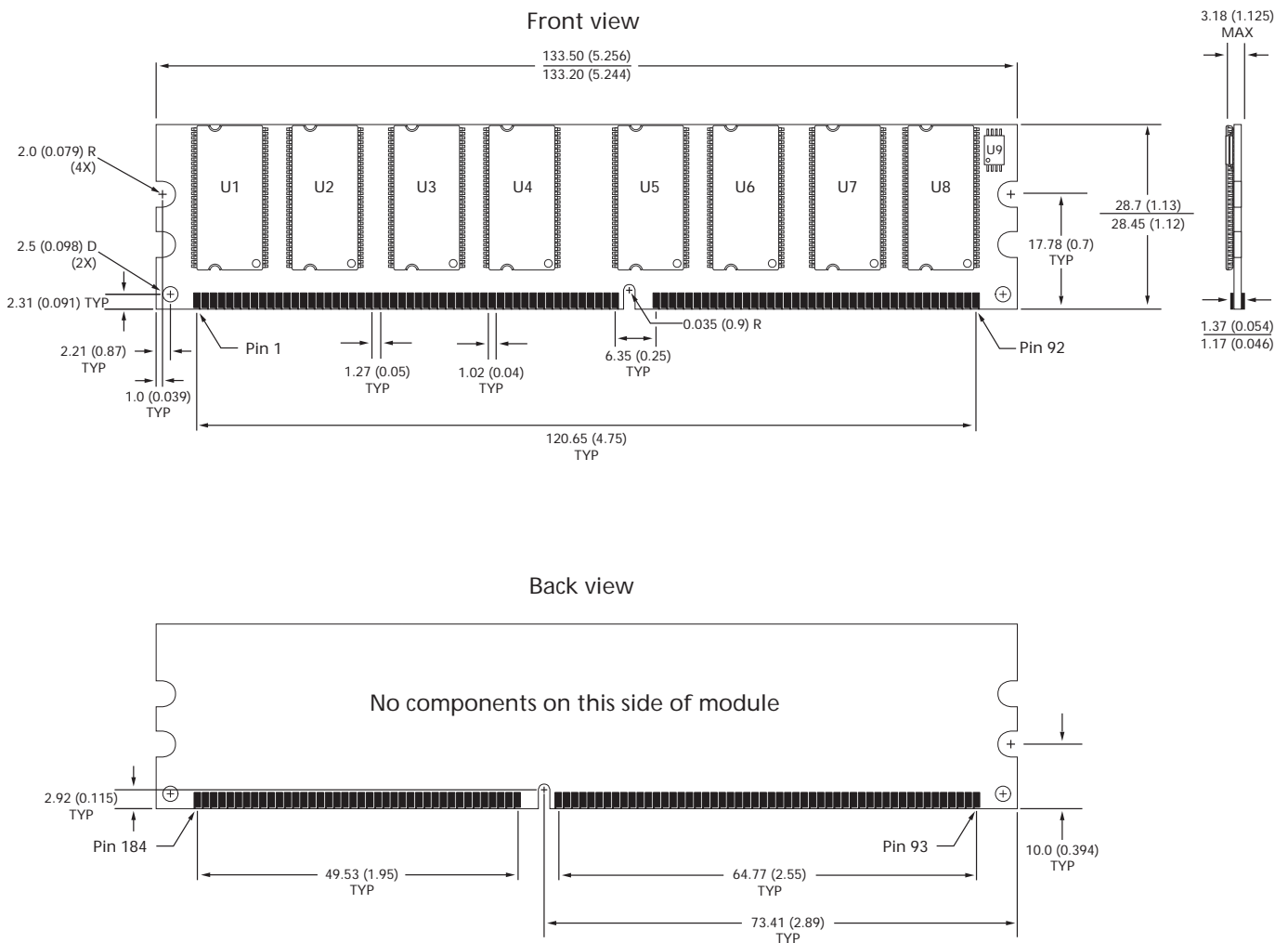

- Notes: 1. All dimensions are in millimeters (inches); MAX/MIN or typical (TYP) where noted.  
2. The dimensional diagram is for reference only. Refer to the JEDEC MO document for additional design dimensions.



8000 S. Federal Way, P.O. Box 6, Boise, ID 83707-0006, Tel: 208-368-3900

prodmktg@micron.com www.micron.com Customer Comment Line: 800-932-4992

Micron, the M logo, and the Micron logo are trademarks of Micron Technology, Inc. All other trademarks are the property of their respective owners.

This data sheet contains minimum and maximum limits specified over the power supply and temperature range set forth herein. Although considered final, these specifications are subject to change, as further product development and data characterization sometimes occur.