

## 阅读申明

- 1.本站收集的数据手册和产品资料都来自互联网，版权归原作者所有。如读者和版权方有任何异议请及时告之，我们将妥善解决。
- 2.本站提供的中文数据手册是英文数据手册的中文翻译，其目的是协助用户阅读，该译文无法自动跟随原稿更新，同时也可能存在翻译上的不当。建议读者以英文原稿为参考以便获得更精准的信息。
- 3.本站提供的产品资料，来自厂商的技术支持或者使用者的心得体会等，其内容可能存在描述上的差异，建议读者做出适当判断。
- 4.如需与我们联系，请发邮件到marketing@iczoom.com，主题请标有“数据手册”字样。

## Read Statement

1. The datasheets and other product information on the site are all from network reference or other public materials, and the copyright belongs to the original author and original published source. If readers and copyright owners have any objections, please contact us and we will deal with it in a timely manner.
2. The Chinese datasheets provided on the website is a Chinese translation of the English datasheets. Its purpose is for reader's learning exchange only and do not involve commercial purposes. The translation cannot be automatically updated with the original manuscript, and there may also be improper translations. Readers are advised to use the English manuscript as a reference for more accurate information.
3. All product information provided on the website refer to solutions from manufacturers' technical support or users the contents may have differences in description, and readers are advised to take the original article as the standard.
4. If you have any questions, please contact us at marketing@iczoom.com and mark the subject with "Datasheets" .

## Motion and Motor Control Solutions



Reliable, accurate positioning and motion control for seamless industrial automation

- » Stand-alone open platform motion controller
- » Servo drives and motors
  - » Energy-saving AC inverters
- » PLC-based motion and position controllers
  - » Cam positioners and rotary encoders

## Contents

|   |   |      |
|---|---|------|
| <b>Selection guide</b>                              |   | I-ii |
| <b>TJ1-<sub>1</sub></b> Trajexia Motion Controller, |   | I-1  |
| <b>Servo drives and motors</b>                      |   |      |
| <b>W-Series</b>                                     | Full-featured servo system; advanced setup tools, diagnostics, and comm.      | I-5  |
| <b>SmartStep</b>                                    | Economical, easy-to-use servo system ideal for stepper upgrades               | I-12 |
| <b>Inverters</b>                                    |   |      |
| <b>3G3JV</b>  | Compact AC inverter for simple motor control                                  | I-20 |
| <b>3G3MV</b>  | Compact inverter offers Loop Vector and V/Hz control                          | I-22 |
| <b>G5+</b>  | Flux vector inverter, 600V, constant torque (Canada only)                     | I-25 |
| <b>P5+</b>  | Powerful 600V variable torque inverter (Canada only)                          | I-28 |
| <b>RV</b>   | Flux vector inverter, general-purpose and high-end applications (Canada only) | I-30 |
| <b>Position controllers/high-speed counters</b>     |   |      |
| <b>CJ1/CS1-NC/-CT/-HC</b>                           | PLC-based accurate positioning control  | I-33 |
| <b>Motion controllers</b>                           |   |      |
| <b>CJ1/CS1-MC</b>                                   | High-speed PLC-based motion controllers                                       | I-37 |
| <b>Soft starters</b>                                |   |      |
| <b>G3JA</b>   | 3-phase hybrid soft starters extend motor life                                | I-39 |
| <b>Cam positioners</b>                              |   |      |
| <b>H8PS</b>   | Stand-alone cam positioner uses encoder input                                 | I-41 |
| <b>C200H-CP114</b>                                  | PLC-based cam positioner uses resolver input                                  | I-43 |

|                             |   |      |
|-----------------------------|---|------|
| <b>Rotary encoders</b>      |   |      |
| <b>Absolute encoders</b>    |   |      |
| <b>E6C3-A</b>               | Water resistant encoder for tough environments  | I-44 |
| <b>E6CP</b>                 | Low-cost absolute encoder, 50 mm diameter       | I-45 |
| <b>E6F-A</b>                | Rugged encoder for high-precision detections    | I-46 |
| <b>Incremental encoders</b> |   |      |
| <b>E6A2-C</b>               | Miniature positioning solution for tight spaces | I-47 |
| <b>E6B2-C</b>               | General-purpose compact encoders                | I-48 |
| <b>E6C3-C</b>               | Water resistant encoder for tough environments  | I-49 |
| <b>E6D</b>                  | Rugged, high-resolution encoder                 | I-50 |
| <b>E6F-C</b>                | Rugged encoder with strong shaft                | I-50 |

## Selection Guide

### Servo Drives and Motors

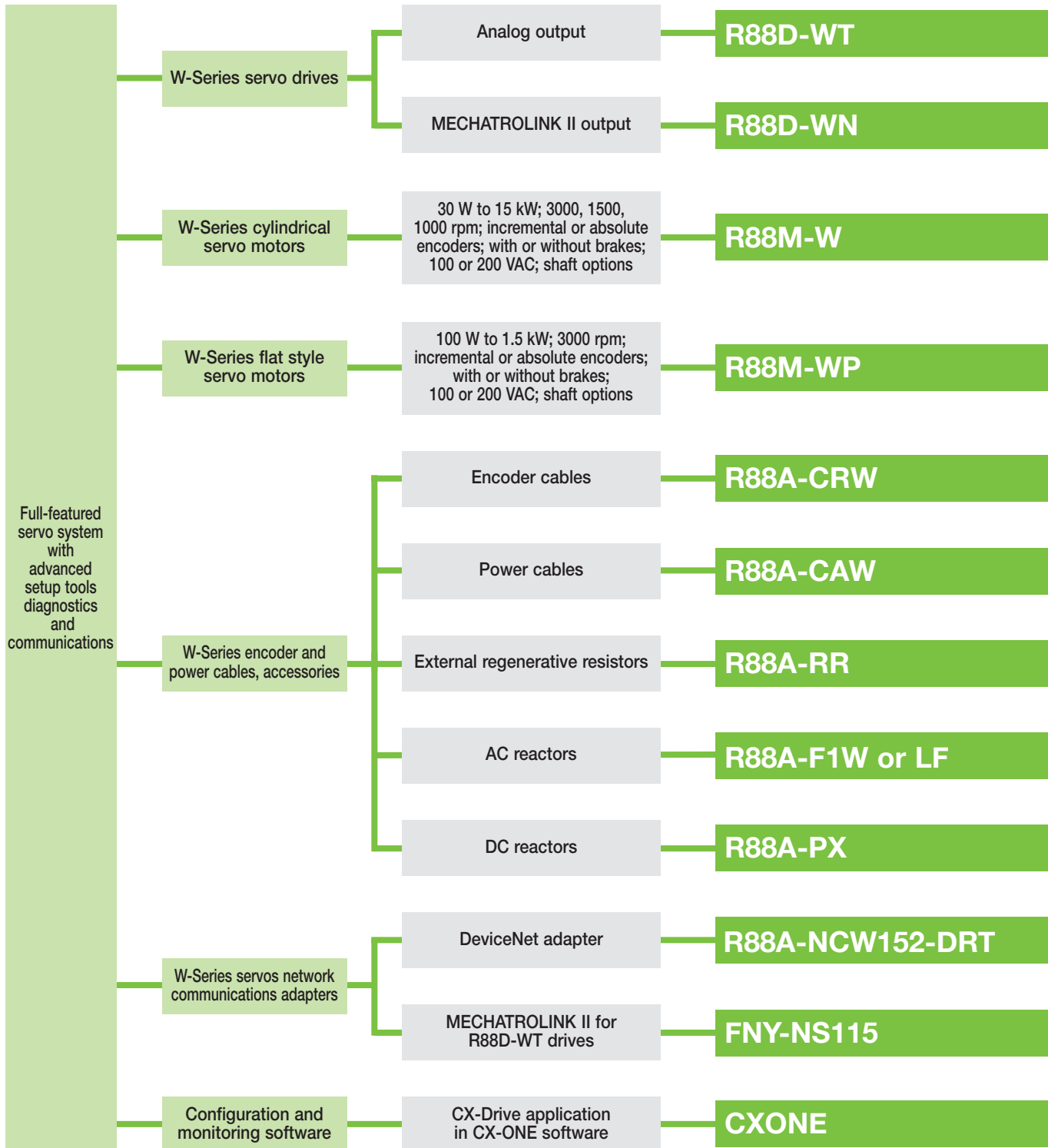

## Selection Guide

### Servo Drives and Motors

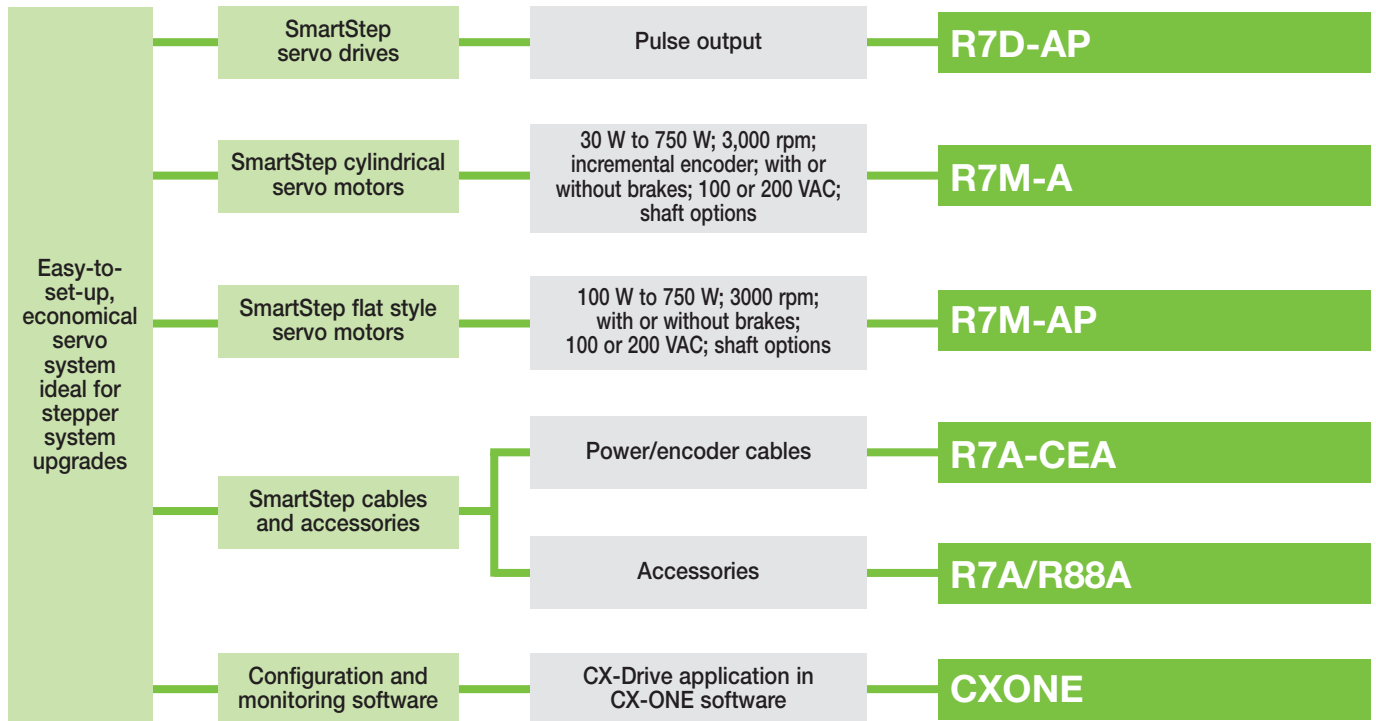

### Inverters



## Selection Guide

### Inverters

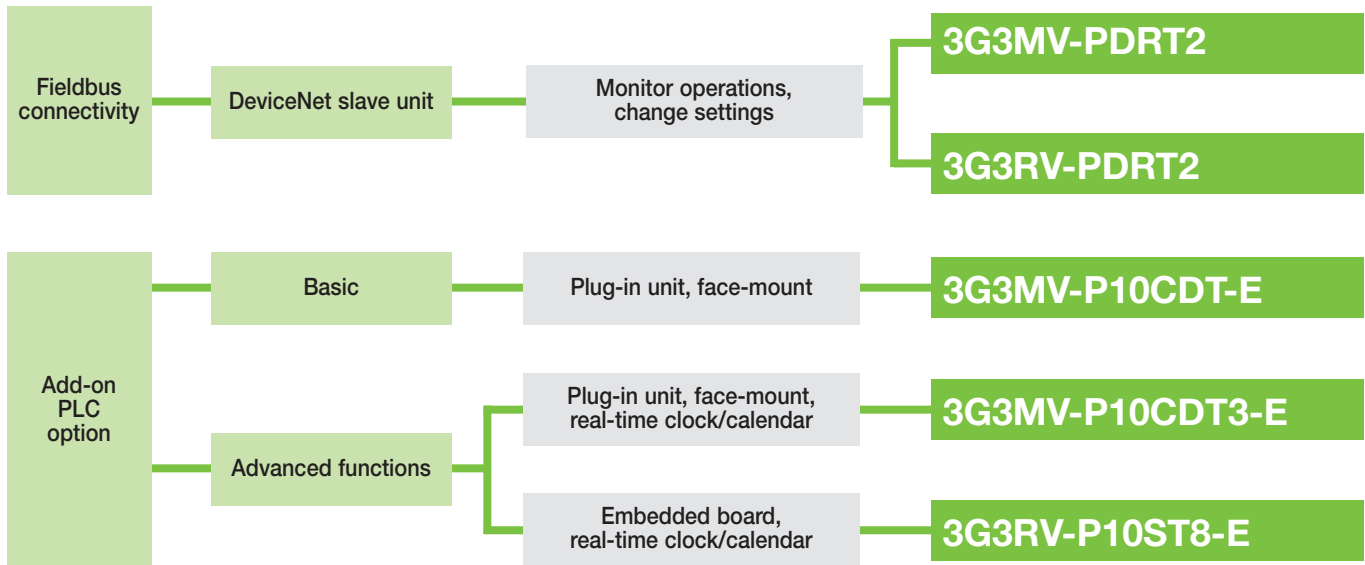

### Position Controllers

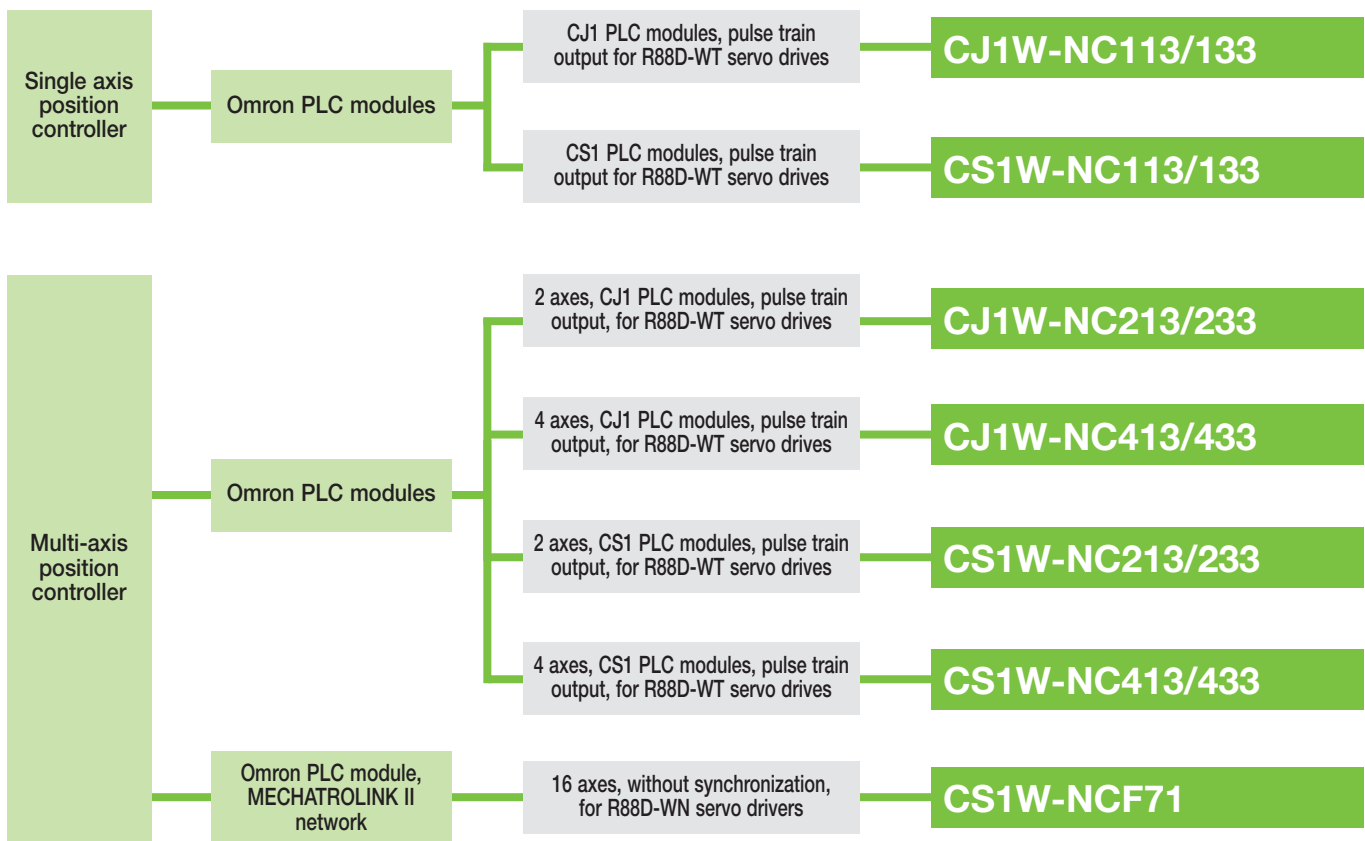

## Selection Guide

### Motion Controllers

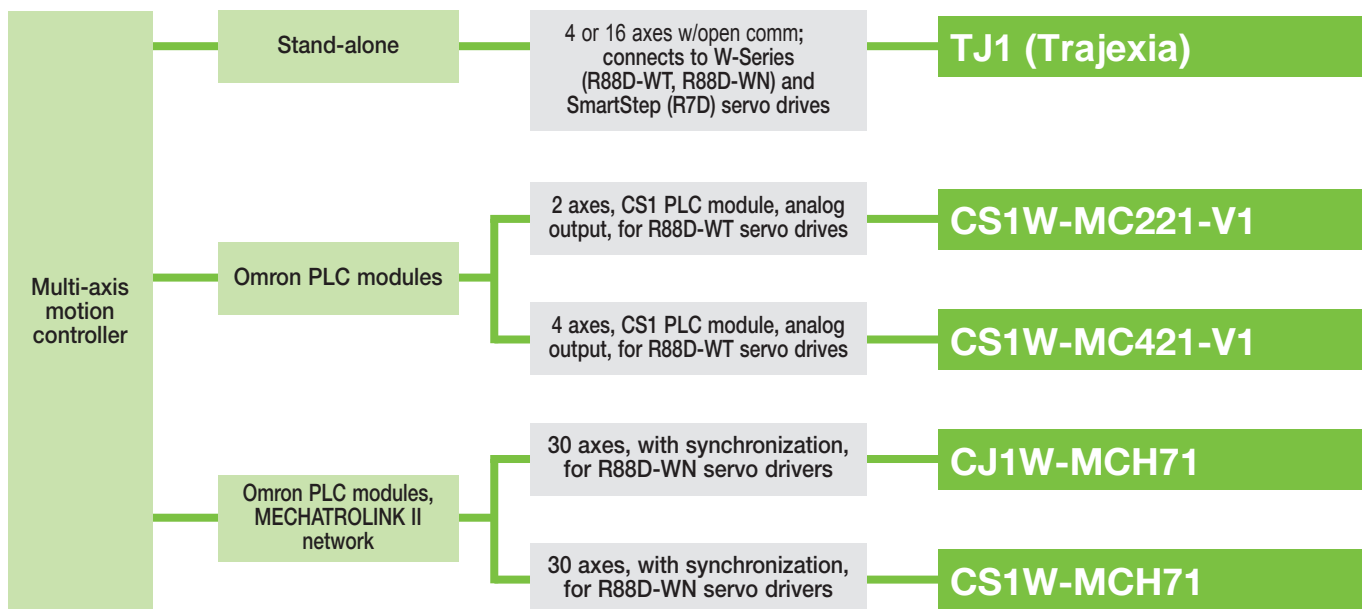

### Motion Controllers Used with Servos and Inverters

| Type   | Controller   | Servo   | Inverter    |
|--|--|---|-------------|
| Stand-alone                                  | TJ1 (Trajexia)                                       | W-Series: R88D-WT servo drives                                | 3G3MV/3G3RV |
| PLC module                                   | “-NC” modules or other controller with pulse train   | W-Series: R88D-WT servo drives<br>SmartStep: R7D servo drives | —           |
|  | “-MC” modules or other controller with analog output | W-Series: R88D-WT servo drives                                | 3G3MV/3G3RV |
| PLC module with control over MECHATROLINK II | CJ1W-NCF71 module                                    | W-Series: R88D-WN servo drives                                | —           |
|  | “-MCH71” modules                                     | W-Series: R88D-WN servo drives                                | 3G3MV/3G3RV |

## Selection Guide

### High-Speed Counter PLC Modules

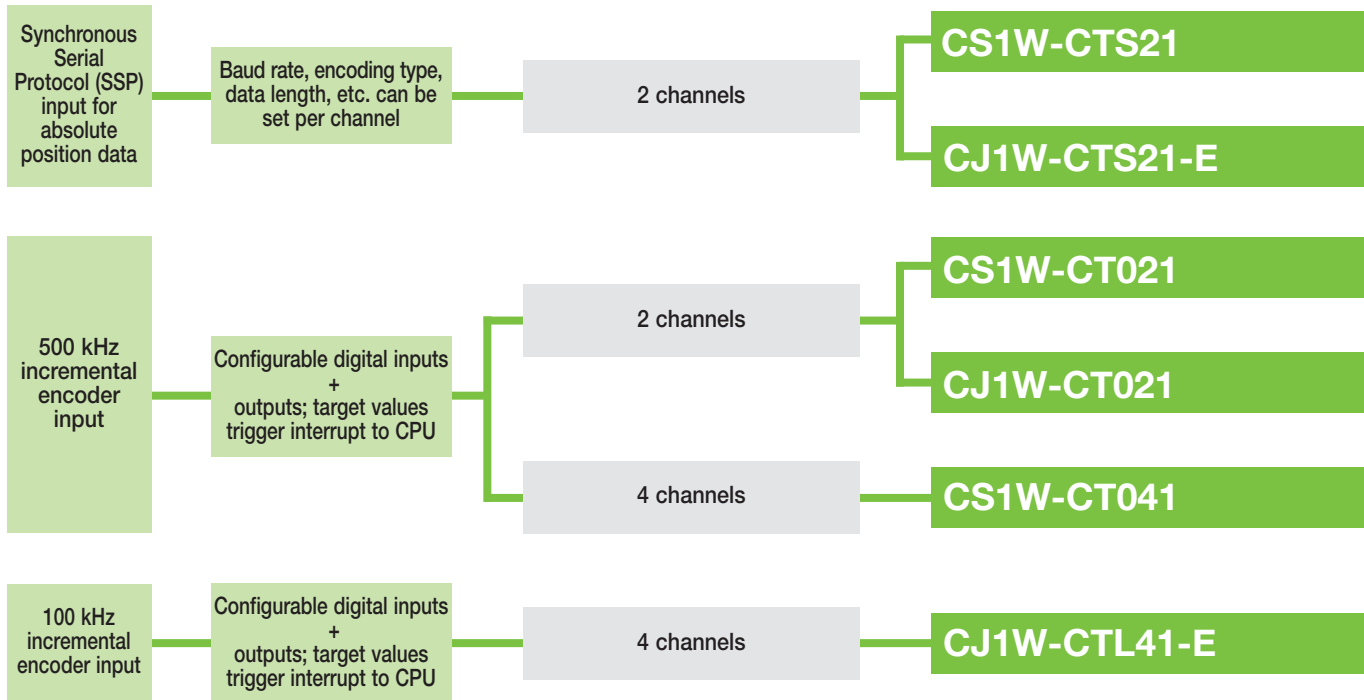

### Cam Positioners Emulate Mechanical Cam Switches

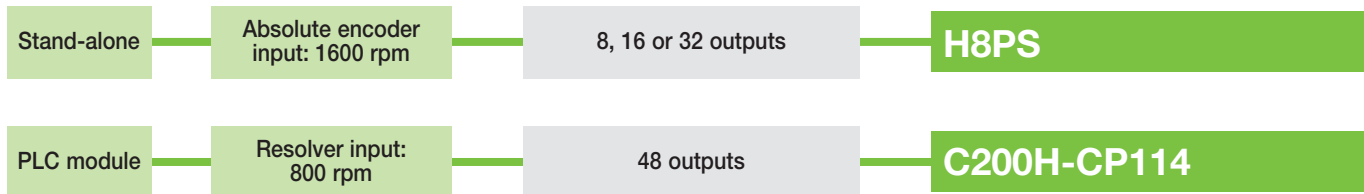

### Soft Starters

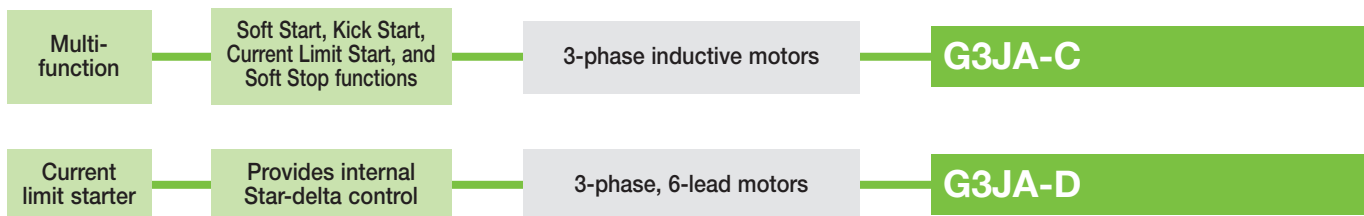



# Rotary Encoders

## Selection Guide

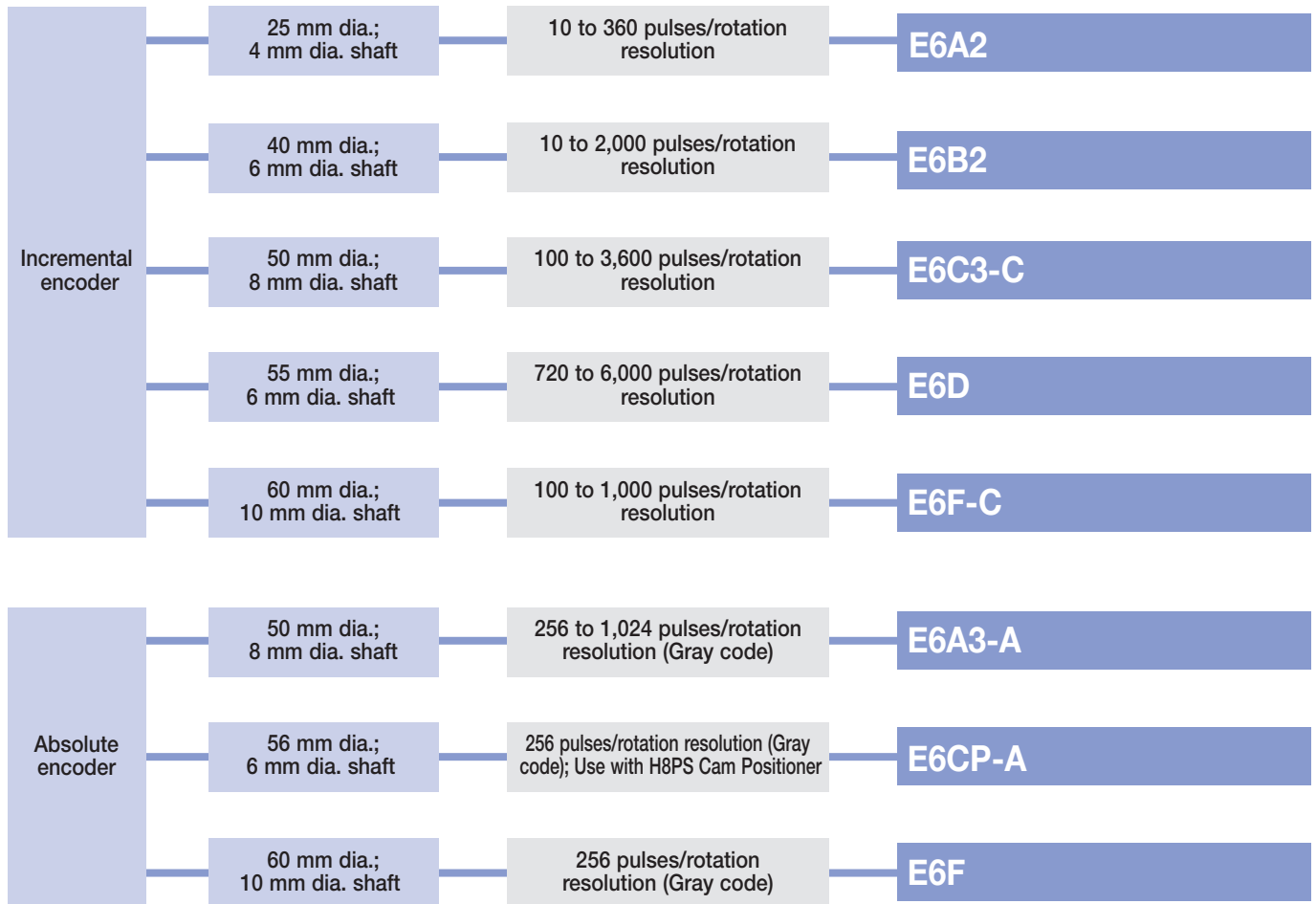

# Trajexia Motion Controller

# TJ1-□



## Stand-Alone Advanced Motion Controller Using Mechatrolink-II Motion Bus

- 16 axes advanced motion coordination over a robust and fast motion link MECHATROLINK-II
- Supports position, speed and torque control
- Each axis can run complex interpolation moves, e-cams and e-gearboxes
- Advanced debugging tools including trace and oscilloscope functions
- Hardware registration input for each servo axis
- Control of servos, inverters and I/Os over a single motion network
- Multi-tasking controller capable of running up to 14 tasks simultaneously
- Open communication - Ethernet built-in, PROFIBUS-DP and DeviceNet as options



## System Configuration

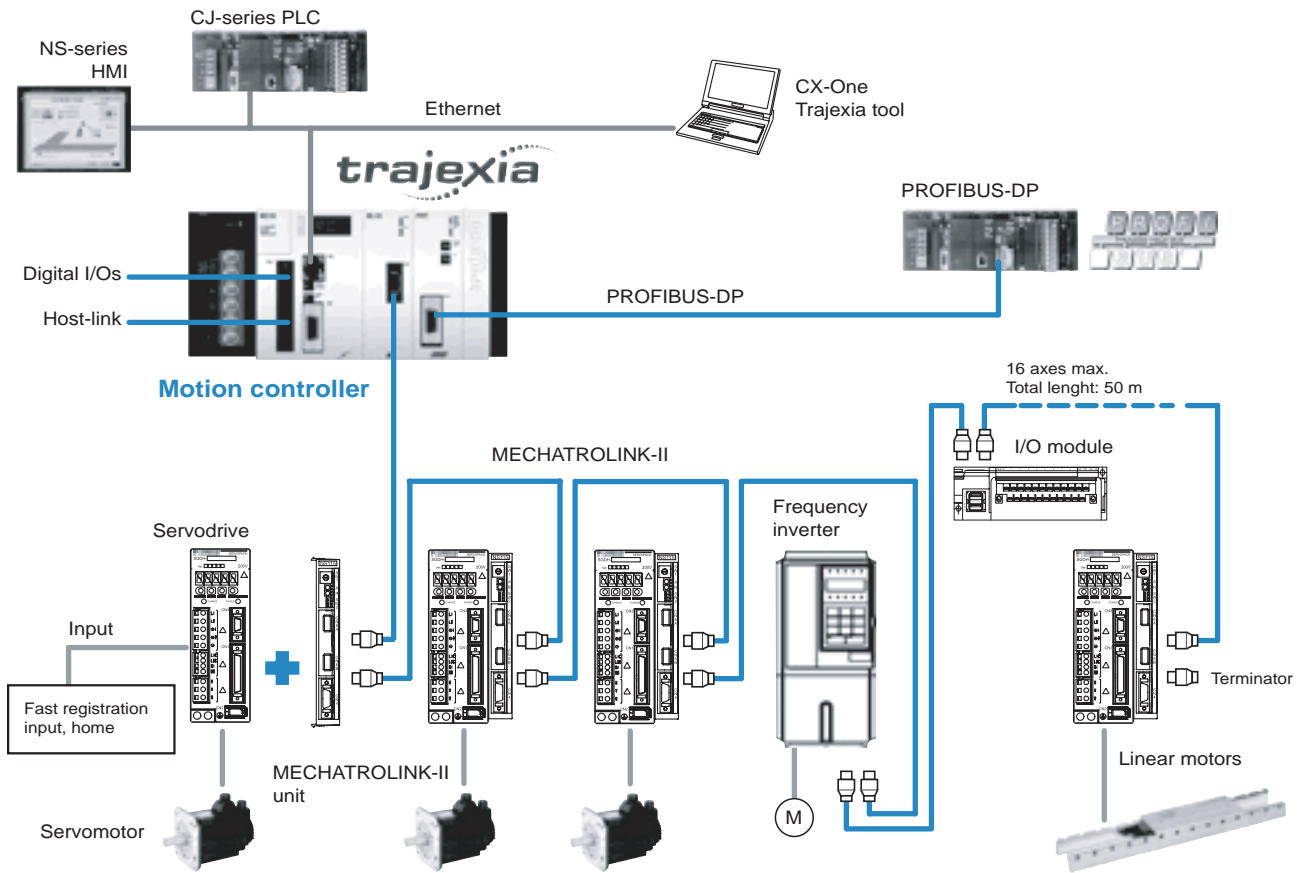

## Specifications

### General Specifications

| Item                          | Details  |
|-------------------------------|--|
| Model                         | TJ1-□  |
| Ambient operating temperature | 0 to 55°C  |
| Ambient operating humidity    | 10 to 90% RH   |
| Ambient storage temperature   | -20 to 70°C  |
| Ambient storage humidity      | 90% max. (with no condensation)  |
| Atmosphere                    | No corrosive gases   |
| Vibration resistance          | 10 to 57 Hz: (0.075 mm amplitude)<br>57 to 100 Hz Acceleration: 9.8 m/s <sup>2</sup> , in X, Y and Z directions for 80 minutes |
| Shock resistance              | 143 m/s <sup>2</sup> , 3 times each X, Y and Z directions  |
| Insulation resistance         | 20 MOhm  |
| Dielectric strength           | 500 Volt   |
| Protective structure          | IP20   |
| International standards       | cULus, CE, EN 61131-2 and RoHS   |

### Motion Control Unit

| Item                                   | Details   |   |  |
|--|---|---|--|
| Model                                  | TJ1-MC16  |   |  |
| Number of axes                         | 16  |   |  |
| Number of inverters and I/O modules    | 8 maximum   |   |  |
| Number of Mechatrolink-II master units | Up to 4 Mechatrolink-II master units (TJ1-ML16, see below) can be connected                 |   |  |
| Cycle time                             | Selectable 0.5 ms, 1 ms or 2 ms   |   |  |
| Programming language                   | BASIC-like Motion language  |   |  |
| Multi-tasking                          | Up to 14 tasks running simultaneously   |   |  |
| Digital I/O                            | 16 Inputs and 8 Outputs freely configurable   |   |  |
| Measurement units                      | User definable  |   |  |
| Available memory for user programs     | 500 kb  |   |  |
| Data storage capacity                  | Up to 2 MB flash data storage   |   |  |
| Saving program data, motion controller | SRAM with battery backup and Flash-ROM  |   |  |
| Saving program data, personal computer | Trajexia Motion Perfect software manages a backup on the hard disk of the personal computer |   |  |
| Communication ports                    | 1 Ethernet port and 2 serial ports  |   |  |
| Firmware update                        | Via Trajexia software tool  |   |  |
| Ethernet port                          | Electrical characteristics  | Conform to IEEE 802.3 (100BaseT)  |  |
|  | Connector   | RJ45 Ethernet connector   |  |
| Serial port                            | Electrical characteristics  | Conform 1 port to RS-232C and 1 port to RS-485/RS-422A (selectable by switch) |  |
|  | Connector   | SUB-D9 connector (Counterpart included in the package)                        |  |
|  | Synchronization   | Start-stop synchronization (asynchronous)                                     |  |
|  | Baud rate   | 1200 / 2400 / 4800 / 9600 / 19200 / 38400 bps                                 |  |
|  | Transmission format   | Databit Length  | 7 or 8 bit   |
|  |   | Stop bit  | 1 or 3 bit   |
|  |   | Parity Bit  | Even/Odd/None  |
|  | Transmission mode   | Point-to-multipoint (1:N)   |  |
|  | Transmission protocol   | RS-232C (1:1)   | Host Link master protocol,<br>Host Link slave protocol,<br>ASCII general-purpose |
|  |   | RS-422A (1:N)   | Host Link master protocol,<br>Host Link slave protocol,<br>ASCII general-purpose |
|  |   | RS-485 (1:N)  | ASCII general-purpose  |
| Galvanic isolation                     | RS-422A port  |   |  |
| Communication buffers                  | 254 bytes   |   |  |
| Flow control                           | None  |   |  |
| Terminator                             | Yes, selectable by switch   |   |  |
| Cable length                           | 15 m for RS-232 and 500 m for RS-422/RS-485   |   |  |

## Mechatrolink-II Master Unit

| Item  | Specifications  |
|---|---|
| Model   | TJ1-ML16  |
| Controlled devices with Mechatrolink-II interface | Servo drives, various I/O units and Frequency inverters                       |
| Electrical characteristics                        | Conform to MECHATROLINK standard  |
| Communication ports                               | 1 MECHATROLINK-II master  |
| Transmission speed                                | 10 Mbps   |
| Communication cycle                               | 0.5 ms, 1 ms or 2 ms  |
| Stations slave types                              | Axes or Servo drives<br>Frequency inverters<br>I/O Modules                    |
| Number of stations per master / Cycle time        | Max. 16 Stations / 2 ms<br>Max. 8 Stations / 1 ms<br>Max. 4 Stations / 0.5 ms |
| Transmission distance                             | Max. 50 meters without using repeater   |

## Profibus Slave Unit

| Items               | Specifications  |
|---------------------|---|
| Model               | TJ1-PRT   |
| PROFIBUS standard   | Conform to PROFIBUS-DP standard EN50170 (DP-V0)                         |
| Communication ports | 1 PROFIBUS-DP slave   |
| Transmission speed  | 9.6, 19.2, 45.45, 93.75, 187.5, 500, 1500, 3000, 6000 and 12000 kbits/s |
| Node numbers        | 0 to 99   |
| I/O size            | For both directions a configurable size of 0 to 122 words (16-bit)      |
| Galvanic isolation  | Yes   |

## DeviceNet Slave Unit

| Items               | Specifications  |
|---------------------|---|
| Model               | TJ1-DRT   |
| DeviceNet standard  | Conforms to DeviceNet standard of CIP edition 1           |
| Communication ports | 1 DeviceNet slave connector                               |
| Transmission speed  | 125, 250 and 500 Kbps, auto-detected                      |
| Node numbers        | 0 to 63   |
| I/O size            | 0 to 32 words (16-bit), configurable, for both directions |
| Galvanic isolation  | Yes   |

## Flexible Axis Unit

| Items              | Specifications   |                                     |
|--------------------|--|-------------------------------------|
| Model              | TJ1-FL02   |                                     |
| Number of axes     | 2  |                                     |
| Control method     | ±10 V Analog Output in closed loop or pulse train output in open loop                                    |                                     |
| Encoder            | Position/speed feedback  | 2 Incremental and Absolute encoders |
|                    | Absolute encoder standards supported   | SSI, EnDat and Tamagawa             |
|                    | Encoder Input maximum frequency  | 6 MHz                               |
|                    | Encoder/Pulse Output max. frequency  | 2 MHz                               |
| Auxiliary I/Os     | 2 Fast registration inputs, 2 definable inputs, 2 Enable output, 4 position switch outputs or axes reset |                                     |
| Galvanic isolation | Yes  |                                     |

## Ordering Information

### Trajexia Motion Controller

| Name   | Model      |
|--|------------|
| Trajexia Motion Controller Unit, 16 axes (Trajexia end cover unit TJ1-TER is included) | TJ1-MC16   |
| Trajexia Motion Controller Unit, 4 axes (Trajexia end cover unit TJ1-TER is included)  | TJ1-MC04   |
| Power Supply for Trajexia system, 100-240V AC  | CJ1W-PA202 |
| Power Supply for Trajexia system, 24V DC   | CJ1W-PD022 |

### Trajexia — Axes Control Modules

| Name   | Model    |
|--|----------|
| Trajexia MECHATROLINK-II Master Unit (up to 16 axes) | TJ1-ML16 |
| Trajexia MECHATROLINK-II Master Unit (up to 4 axes)  | TJ1-ML04 |
| Trajexia Flexible Axis Unit (for 2 axes)             | TJ1-FL02 |

### Trajexia — Communication Modules

| Name                            | Model   |
|---------------------------------|---------|
| Trajexia DeviceNet Slave Unit   | TJ1-PRT |
| Trajexia PROFIBUS-DP Slave Unit | TJ1-PRT |

### Mechatrolink-II — Related Devices

| Name                           | Remarks  | Model        |
|--------------------------------|--|--------------|
| Distributed I/O modules        | 64-point digital input and 64-point digital output (24 VDC)                        | FNY-IO2310   |
|                                | Analog input: -10 V to +10 V, 4 channels   | FNY-AN2900   |
|                                | Analog output: -10 V to +10 V, 2 channels  | FNY-AN2910   |
| Mechatrolink-II cables         | 0.5 meter  | FNY-W6003-A5 |
|                                | 1 meter  | FNY-W6003-01 |
|                                | 3 meters   | FNY-W6003-03 |
|                                | 5 meters   | FNY-W6003-05 |
|                                | 10 meters  | FNY-W6003-10 |
|                                | 20 meters  | FNY-W6003-20 |
|                                | 30 meters  | FNY-W6003-30 |
| Mechatrolink-II terminator     | Terminating resistor   | FNY-W6022    |
| Mechatrolink-II interface unit | For W-series Servo drives (Firmware version 39 or later)                           | FNY-NS115    |
|                                | For Inverter<br>(For Inverter's version supported contact your Omron sales office) | SI-TV7       |
|                                | For Inverter<br>(For Inverter's version supported contact your Omron sales office) | SI-T         |

### I/O Cables

| Name                     | Remarks  | Length | Model        |
|--------------------------|--|--------|--------------|
| I/O Cable for FNY-IO2310 | With connector on the Distributed I/O module side (FNY-IO2310) | 0.5 m  | FNY-W5410-05 |
|                          |  | 1.0 m  | FNY-W5410-10 |
|                          |  | 3.0 m  | FNY-W5410-30 |

### Servo System and Inverters

**Note:** Contact your Omron sales office for detailed specs and ordering information

### Software

| Specifications                                      | Model     |
|---|-----------|
| Trajexia Motion Perfect and CX-Drive V1.2 or higher | TJ1-Tools |

# Servos W-Series

Quick Link  
L100

## High-Precision Positioning with Advanced Communications

Omron's compact W-Series servos were designed with zero compromise on quality, reliability or performance. The servo amplifiers are ultra-compact with pulse and analog inputs as standard, plus an auto-tuning function. Plug-in option cards offer enhanced functionality such as indexing and complex motions such as cams, gears and linked axes.

MECHATROLINK-II high-speed bus provides instant communications between Omron's W-Series servo drives and PLC-based motion controllers and simplifies coordination of up to 30 axes.

### Servo Driver Features

- 300% peak current for 3 seconds
- Automatic motor recognition with auto-tuning function
- Analog and pulse inputs for speed, torque and position control
- MECHATROLINK-II communications bus available built-in (WN-drives) or as an option unit (WT-drives)
- Field bus option units include DeviceNet and Profibus
- Special function option units available for motion controller and indexer
- Trace function allows oscilloscope function for monitoring

### Servo Motor Features

- 6 different designs provide a complete range of servo motors to meet the power, speed and performance required for each application
- Peak torque 300% of nominal during 3 seconds
- Slim profile and standard cylindrical motor types
- High resolution incremental encoders standard, absolute encoders available
- Built-in 24V brake available
- Shaft options include straight, with keyway, and with keyway and tap
- IP67 and shaft oil seal available

MECHATROLINK-II is a registered trademark of Yaskawa Corporation.



## Servo Motor and Servo Drive Combinations

Servo motors with absolute encoders are available but not shown below.

| Servo Motor (R88M-W□□□□□□-□□□)  |                |                  |                                    | Servo drive model with MECHATROLINK-II communications (R88D-WN□□□-ML2) |                |                | Servo drive model (R88D-WT□□□□) |                |                |
|---|----------------|------------------|------------------------------------|--|----------------|----------------|---------------------------------|----------------|----------------|
| Description   | Capacity       | Model (-W□□□□□□) | Brake and Shaft end options (-□□□) | 100 V  | 200 V, 1-phase | 200 V, 3-phase | 100 V                           | 200 V, 1-phase | 200 V, 2-phase |
| Cylindrical 3000 rpm, incremental encoder, IP55 (excluding shaft opening)                                   | 30 W           | <b>03030H</b>    | Without brake (blank)              | —  | —              | —              | A3HL                            | A3H            | —              |
|   | 50 W           | <b>05030H</b>    | With brake (-B)                    | A5L  | A5H            | —              | A5HL                            | A5H            | —              |
|   | 100 W          | <b>10030H</b>    | Straight shaft (blank)             | 01L  | 01H            | —              | 01HL                            | 01H            | —              |
|   | 200 W          | <b>20030H</b>    | Shaft with key (-S1)               | 02L  | 02H            | —              | 02HL                            | 02H            | —              |
|   | 400 W          | <b>40030H</b>    | Shaft with key and tap (-S2)       | 04L  | 04H            | —              | —                               | 04H            | —              |
|   | 750 W          | <b>75030H</b>    |                                    | —  | 08H            | —              | —                               | 08H            | 08H            |
| Cylindrical 3000 rpm, incremental encoder, IP67 (excluding shaft opening)                                   | 1 KW           | <b>1K030H</b>    | Without brake (blank)              | —  | —              | 10H            | —                               | —              | 10H            |
|   | 1.5 KW         | <b>1K530H</b>    | With brake (-B)                    | —  | —              | 15H            | —                               | —              | 15H            |
|   | 2 KW           | <b>2K030H</b>    | Straight shaft (blank)             | —  | —              | 20H            | —                               | —              | 20H            |
|   | 3 KW           | <b>3K030H</b>    | Shaft with key and tap (-S2)       | —  | —              | 30H            | —                               | —              | 30H            |
|   | 4 KW           | <b>4K030H</b>    |                                    | —  | —              | —              | —                               | —              | 50H            |
|   | 5 KW           | <b>5K030H</b>    |                                    | —  | —              | —              | —                               | —              | 50H            |
| Cylindrical 1500 rpm, incremental encoder, IP67 (excluding shaft opening)                                   | 450 W          | <b>45015H</b>    | Without brake (blank)              | —  | —              | 05H            | —                               | —              | 05H            |
|   | 850 W          | <b>85015H</b>    | With brake (-B)                    | —  | —              | 10H            | —                               | —              | 10H            |
|   | 1.3 KW         | <b>1K315H</b>    | Straight shaft (blank)             | —  | —              | 15H            | —                               | —              | 15H            |
|   | 1.8 KW         | <b>1K815H</b>    | Shaft with key and tap (-S2)       | —  | —              | 20H            | —                               | —              | 20H            |
|   | 2.9 KW         | <b>2K915H</b>    |                                    | —  | —              | —              | —                               | —              | 30H            |
|   | 4.4 KW         | <b>4K415H</b>    |                                    | —  | —              | —              | —                               | —              | 50H            |
|   | 5.5 KW         | <b>5K515H</b>    |                                    | —  | —              | —              | —                               | —              | 60H*           |
|   | 7.5 KW         | <b>7K515H</b>    |                                    | —  | —              | —              | —                               | —              | 75H*           |
|   | 11 KW          | <b>11K015H</b>   |                                    | —  | —              | —              | —                               | —              | 150H*          |
| 15 KW   | <b>15K015H</b> |                  | —                                  | —  | —              | —              | —                               | 150H*          |                |
| Cylindrical 1000 rpm, incremental encoder, IP67 (excluding shaft opening)                                   | 300 W          | <b>30010H</b>    | Without brake (blank)              | —  | —              | 05H            | —                               | —              | 05H            |
|   | 600 W          | <b>60010H</b>    | With brake (-B)                    | —  | —              | 10H            | —                               | —              | 08H            |
|   | 900 W          | <b>90010H</b>    | Straight shaft (blank)             | —  | —              | 10H            | —                               | —              | 10H            |
|   | 1.2 KW         | <b>1K210H</b>    | Shaft with key and tap (-S2)       | —  | —              | 15H            | —                               | —              | 15H            |
|   | 2 KW           | <b>2K010H</b>    |                                    | —  | —              | 20H            | —                               | —              | 20H            |
|   | 3 KW           | <b>3K010H</b>    |                                    | —  | —              | —              | —                               | —              | 30H            |
|   | 4 KW           | <b>4K010H</b>    |                                    | —  | —              | —              | —                               | —              | 50H            |
|   | 5 KW           | <b>5K010H</b>    |                                    | —  | —              | —              | —                               | —              | 60H*           |
| Flat style, 3000 rpm, incremental encoder, IP55 (excluding shaft opening) or IP67 (including shaft opening) | 100 W          | <b>P10030H</b>   | Without brake (blank)              | 01L  | 01H            | —              | 01HL                            | 01H            | —              |
|   | 200 W          | <b>P20030H</b>   | With brake (-B)                    | 02L  | 02H            | —              | 02HL                            | 02H            | —              |
|   | 400 W          | <b>P40030H</b>   | Straight shaft (blank)             | 04L  | 04H            | —              | —                               | 04H            | —              |
|   | 750 W          | <b>P75030H</b>   | Shaft with key (-S1)               | —  | 08H            | —              | —                               | 08H            | 08H            |
|   | 1.5 KW         | <b>P1K530H</b>   | Shaft with key and tap (-S2)       | —  | —              | 15H            | —                               | —              | 15H            |
|   |                |                  |                                    | —  | —              | —              | —                               | —              | —              |

**Note:** \*A regenerative resistor (model R88A-RR8806) must be ordered with these servo drivers.

## Ordering Information

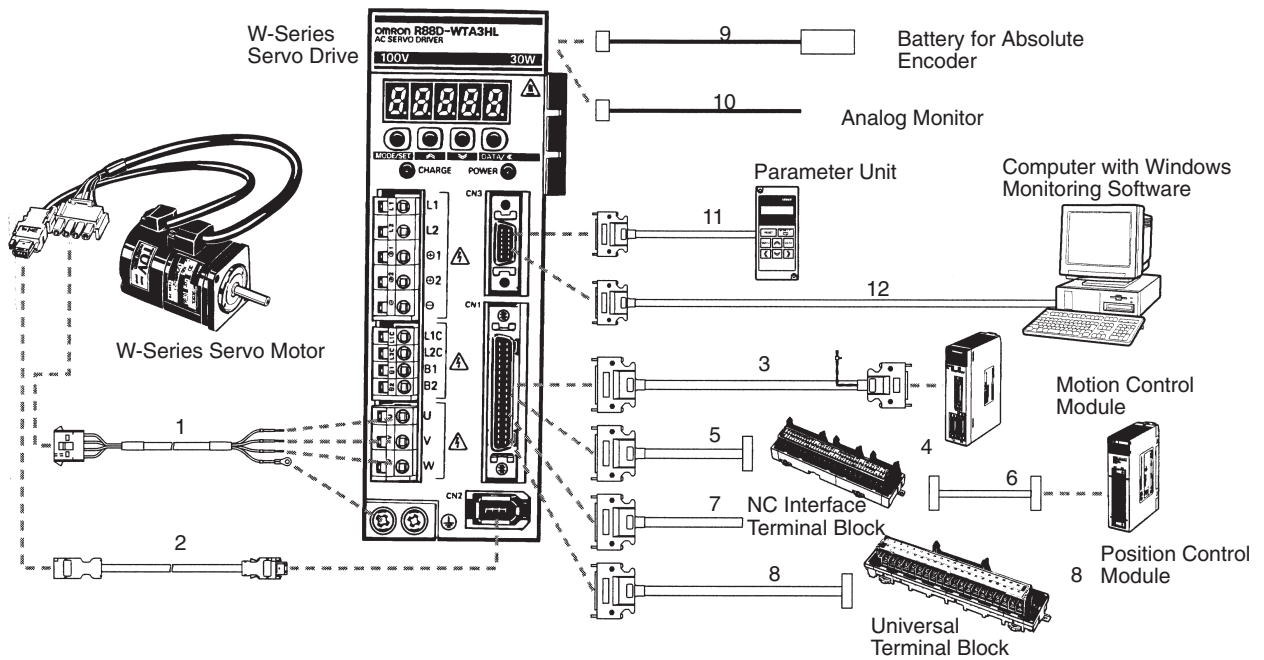

## Servo Drives (R88D)

| Watts  | Voltage | Phase | Model       |                      |
|--------|---------|-------|-------------|----------------------|
|        |         |       | Standard    | With MECHATROLINK-II |
| 30     | 100     | 1     | R88D-WTA3HL | —                    |
| 50     | 100     | 1     | R88D-WTA5HL | R88D-WNA5L-ML2       |
| 100    | 100     | 1     | R88D-WT01HL | R88D-WN01L-ML2       |
| 200    | 100     | 1     | R88D-WT02HL | R88D-WN02L-ML2       |
| 400    | 100     | 1     | —           | R88D-WN04L-ML2       |
| 30     | 200     | 1     | R88D-WTA3H  | —                    |
| 50     | 200     | 1     | R88D-WTA5H  | R88D-WNA5H-ML2       |
| 100    | 200     | 1     | R88D-WT01H  | R88D-WN01H-ML2       |
| 200    | 200     | 1     | R88D-WT02H  | R88D-WN02H-ML2       |
| 400    | 200     | 1     | R88D-WT04H  | R88D-WN04H-ML2       |
| 750    | 200     | 1     | —           | R88D-WN08H-ML2       |
| 500    | 200     | 3     | R88D-WT05H  | R88D-WN05H-ML2       |
| 750    | 200     | 3     | R88D-WT08H  | —                    |
| 1000   | 200     | 3     | R88D-WT10H  | R88D-WN10H-ML2       |
| 1500   | 200     | 3     | R88D-WT15H  | R88D-WN15H-ML2       |
| 2000   | 200     | 3     | R88D-WT20H  | R88D-WN20H-ML2       |
| 3000   | 200     | 3     | R88D-WT30H  | R88D-WN30H-ML2       |
| 4000   | 200     | 3     | R88D-WT50H  | —                    |
| 5000   | 200     | 3     | R88D-WT50H  | —                    |
| 5500   | 200     | 3     | R88D-WT60H  | —                    |
| 7500   | 200     | 3     | R88D-WT75H  | —                    |
| 15,000 | 200     | 3     | R88D-WT150H | —                    |



## Cylindrical Style Servo Motors

R88M-W□□□ □□ □- □ □ □□  
4 5 6 7 8 9

Build a part number as follows:

R88M-W75030T-BS2 = 750 W, 3000 RPM, 200 VAC motor with absolute encoder, brakes, and shaft with key and tap

| 4        | 5              | Basic model       | 6  |     |     |     | 7                   |     | 8  |     |     | 9  |     |     |     |
|----------|----------------|-------------------|--|-----|-----|-----|---------------------|-----|--|-----|-----|--|-----|-----|-----|
| Capacity | Rotation speed | Cylindrical style | Motor power supply and encoder type<br>H = 200 VAC, incremental<br>L = 100 VAC, incremental<br>T = 200 VAC, absolute<br>S = 100 VAC absolute |     |     |     | With/without brakes |     | Oil seal options<br>Blank = none<br>O = oil seal |     |     | Shaft shape<br>Blank: straight<br>S1 = with key<br>S2 = with key and tap<br>S3 = straight with tap |     |     |     |
| W        | RPM            | R88M-W            | H  | L   | T   | S   | Blank               | B   | Blank  | O   | W   | Blank  | S1  | S2  | S3  |
| 30       | 3,000          | R88M-W03030       | Yes  | Yes | Yes | Yes | Yes                 | Yes | Yes  | Yes | —   | Yes  | Yes | Yes | Yes |
| 50       |                | R88M-W05030       | Yes  | Yes | Yes | Yes | Yes                 | Yes | Yes  | Yes | —   | Yes  | Yes | Yes | Yes |
| 100      |                | R88M-W10030       | Yes  | Yes | Yes | Yes | Yes                 | Yes | Yes  | Yes | —   | Yes  | Yes | Yes | Yes |
| 200      |                | R88M-W20030       | Yes  | Yes | Yes | Yes | Yes                 | Yes | Yes  | Yes | —   | Yes  | Yes | Yes | Yes |
| 400      |                | R88M-W40030       | Yes  | —   | Yes | —   | Yes                 | Yes | Yes  | Yes | —   | Yes  | Yes | Yes | Yes |
| 750      |                | R88M-W75030       | Yes  | —   | Yes | —   | Yes                 | Yes | Yes  | Yes | —   | Yes  | Yes | Yes | Yes |
| 1 kW     |                | R88M-W1K030       | Yes  | —   | Yes | —   | Yes                 | Yes | Yes  | Yes | —   | Yes  | —   | Yes | —   |
| 1.5 kW   |                | R88M-W1K530       | Yes  | —   | Yes | —   | Yes                 | Yes | Yes  | Yes | —   | Yes  | —   | Yes | —   |
| 2 kW     |                | R88M-W2K030       | Yes  | —   | Yes | —   | Yes                 | Yes | Yes  | Yes | —   | Yes  | —   | Yes | —   |
| 3 kW     |                | R88M-W3K030       | Yes  | —   | Yes | —   | Yes                 | Yes | Yes  | Yes | —   | Yes  | —   | Yes | —   |
| 4 kW     | R88M-W4K030    | Yes               | —  | Yes | —   | Yes | Yes                 | Yes | Yes  | —   | Yes | —  | Yes | —   |     |
| 5 kW     | R88M-W5K030    | Yes               | —  | Yes | —   | Yes | Yes                 | Yes | Yes  | —   | Yes | —  | Yes | —   |     |
| 450      | 1,500          | R88M-W45015       | —  | —   | Yes | —   | Yes                 | Yes | Yes  | Yes | —   | Yes  | —   | Yes | —   |
| 850      |                | R88M-W85015       | —  | —   | Yes | —   | Yes                 | Yes | Yes  | Yes | —   | Yes  | —   | Yes | —   |
| 1.3 kW   |                | R88M-W1K315       | —  | —   | Yes | —   | Yes                 | Yes | Yes  | Yes | —   | Yes  | —   | Yes | —   |
| 1.8 kW   |                | R88M-W1K815       | —  | —   | Yes | —   | Yes                 | Yes | Yes  | Yes | —   | Yes  | —   | Yes | —   |
| 2.9 kW   |                | R88M-W2K915       | —  | —   | Yes | —   | Yes                 | Yes | Yes  | Yes | —   | Yes  | —   | Yes | —   |
| 4.4 kW   |                | R88M-W4K415       | —  | —   | Yes | —   | Yes                 | Yes | Yes  | Yes | —   | Yes  | —   | Yes | —   |
| 5.5 kW   |                | R88M-W5K515       | —  | —   | Yes | —   | Yes                 | Yes | Yes  | Yes | —   | Yes  | —   | Yes | —   |
| 7.5 kW   |                | R88M-W7K515       | —  | —   | Yes | —   | Yes                 | Yes | Yes  | Yes | —   | Yes  | —   | Yes | —   |
| 11 kW    |                | R88M-W11K015      | —  | —   | Yes | —   | Yes                 | Yes | Yes  | Yes | —   | Yes  | —   | Yes | —   |
| 15 kW    |                | R88M-W15K015      | —  | —   | Yes | —   | Yes                 | Yes | Yes  | Yes | —   | Yes  | —   | Yes | —   |
| 300      | 1,000          | R88M-W30010       | Yes  | —   | Yes | —   | Yes                 | Yes | Yes  | Yes | —   | Yes  | —   | Yes | —   |
| 600      |                | R88M-W60010       | Yes  | —   | Yes | —   | Yes                 | Yes | Yes  | Yes | —   | Yes  | —   | Yes | —   |
| 900      |                | R88M-W90010       | Yes  | —   | Yes | —   | Yes                 | Yes | Yes  | Yes | —   | Yes  | —   | Yes | —   |
| 1.2 kW   |                | R88M-W1K210       | Yes  | —   | Yes | —   | Yes                 | Yes | Yes  | Yes | —   | Yes  | —   | Yes | —   |
| 2 kW     |                | R88M-W2K010       | Yes  | —   | Yes | —   | Yes                 | Yes | Yes  | Yes | —   | Yes  | —   | Yes | —   |
| 3 kW     |                | R88M-W3K010       | Yes  | —   | Yes | —   | Yes                 | Yes | Yes  | Yes | —   | Yes  | —   | Yes | —   |
| 4 kW     |                | R88M-W4K010       | Yes  | —   | Yes | —   | Yes                 | Yes | Yes  | Yes | —   | Yes  | —   | Yes | —   |
| 5.5 kW   |                | R88M-W5K510       | Yes  | —   | Yes | —   | Yes                 | Yes | Yes  | Yes | —   | Yes  | —   | Yes | —   |

## Flat Style Servo Motors

R88M-WP□□□ □□ □- □ □ □□  
4 5 6 7 8 9

Build a part number as follows:

R88M-WP20030H-BWS1 = 200 W, 3000 RPM, 200 VAC motor with absolute encoder, brakes, waterproof seal (IP67), and shaft with key

| 4        | 5              | Basic model  | 6  |     |     |     | 7                   |     | 8   |     |     | 9  |     |     |     |
|----------|----------------|--------------|--|-----|-----|-----|---------------------|-----|---|-----|-----|--|-----|-----|-----|
| Capacity | Rotation speed | Flat style   | Motor power supply and encoder type<br>H = 200 VAC, incremental<br>L = 100 VAC, incremental<br>T = 200 VAC, absolute<br>S = 100 VAC absolute |     |     |     | With/without brakes |     | Waterproof (IP67) /oil seal options<br>Blank = none<br>O = oil seal<br>W = waterproof |     |     | Shaft shape<br>Blank: straight<br>S1 = with key<br>S2 = with key and tap<br>S3 = straight with tap |     |     |     |
| W        | RPM            | R88M-WP      | H  | L   | T   | S   | Blank               | B   | Blank   | O   | W   | Blank  | S1  | S2  | S3  |
| 100 W    | 3,000          | R88M-WP10030 | Yes  | Yes | Yes | Yes | Yes                 | Yes | Yes   | Yes | Yes | Yes  | Yes | Yes | Yes |
| 200 W    |                | R88M-WP20030 | Yes  | Yes | Yes | Yes | Yes                 | Yes | Yes   | Yes | Yes | Yes  | Yes | Yes | Yes |
| 400 W    |                | R88M-WP40030 | Yes  | —   | Yes | —   | Yes                 | Yes | Yes   | Yes | Yes | Yes  | Yes | Yes | Yes |
| 750 W    |                | R88M-WP75030 | Yes  | —   | Yes | —   | Yes                 | Yes | Yes   | Yes | Yes | Yes  | Yes | Yes | Yes |
| 1.5 kW   |                | R88M-WP1K530 | Yes  | —   | Yes | —   | Yes                 | Yes | Yes   | Yes | Yes | Yes  | Yes | Yes | Yes |

Note: Circled numbers refer to the configuration diagram on page I-3.

## ① Servo Motor Power Cables

| Applicable servo motors   | Length | Model                     |                        |
|---|--------|---------------------------|------------------------|
|   |        | For motors without brakes | For motors with brakes |
| 30-W to 750-W Cylindrical style motors (3,000 RPM)<br>100-W to 750-W Flat style motors (3,000 RPM)  | 3 m    | R88A-CAWA003S             | R88A-CAWA003B          |
|   | 5 m    | R88A-CAWA005S             | R88A-CAWA005B          |
|   | 10 m   | R88A-CAWA010S             | R88A-CAWA010B          |
|   | 15 m   | R88A-CAWA015S             | R88A-CAWA015B          |
|   | 20 m   | R88A-CAWA020S             | R88A-CAWA020B          |
|   | 30 m   | R88A-CAWA030S             | R88A-CAWA030B          |
|   | 40 m   | R88A-CAWA040S             | R88A-CAWA040B          |
|   | 50 m   | R88A-CAWA050S             | R88A-CAWA050B          |
| 1.5-kW Flat style motors  | 3 m    | R88A-CAWB003S             | R88A-CAWB003B          |
|   | 5 m    | R88A-CAWB005S             | R88A-CAWB005B          |
|   | 10 m   | R88A-CAWB010S             | R88A-CAWB010B          |
|   | 15 m   | R88A-CAWB015S             | R88A-CAWB015B          |
|   | 20 m   | R88A-CAWB020S             | R88A-CAWB020B          |
|   | 30 m   | R88A-CAWB030S             | R88A-CAWB030B          |
|   | 40 m   | R88A-CAWB040S             | R88A-CAWB040B          |
|   | 50 m   | R88A-CAWB050S             | R88A-CAWB050B          |
| 300-W to 900-W Cylindrical style motors (1,000 RPM)<br>1-kW to 2-kW Cylindrical style motors (3,000 RPM)  | 3 m    | R88A-CAWC003S             | R88A-CAWC003B          |
|   | 5 m    | R88A-CAWC005S             | R88A-CAWC005B          |
|   | 10 m   | R88A-CAWC010S             | R88A-CAWC010B          |
|   | 15 m   | R88A-CAWC015S             | R88A-CAWC015B          |
|   | 20 m   | R88A-CAWC020S             | R88A-CAWC020B          |
|   | 30 m   | R88A-CAWC030S             | R88A-CAWC030B          |
|   | 40 m   | R88A-CAWC040S             | R88A-CAWC040B          |
|   | 50 m   | R88A-CAWC050S             | R88A-CAWC050B          |
| 1.2-kW to 3-kW Cylindrical style servo motors (1,000 RPM)<br>3-kW to 5-kW Cylindrical style servo motors (3,000 RPM)<br>1.8 kW to 4.4 kW Cylindrical style servo motors (1,500 RPM) | 3 m    | R88A-CAWD003S             | R88A-CAWD003B          |
|   | 5 m    | R88A-CAWD005S             | R88A-CAWD005B          |
|   | 10 m   | R88A-CAWD010S             | R88A-CAWD010B          |
|   | 15 m   | R88A-CAWD015S             | R88A-CAWD015B          |
|   | 20 m   | R88A-CAWD020S             | R88A-CAWD020B          |
|   | 30 m   | R88A-CAWD030S             | R88A-CAWD030B          |
|   | 40 m   | R88A-CAWD040S             | R88A-CAWD040B          |
|   | 50 m   | R88A-CAWD050S             | R88A-CAWD050B          |
| 5.5 kW Cylindrical style servo motors (1,500 RPM)<br>4 kW Cylindrical style servo motors (1,000 RPM)  | 3 m    | R88A-CAWE003S             | R88A-CAWE003B §        |
|   | 5 m    | R88A-CAWE005S             | R88A-CAWE005B §        |
|   | 10 m   | R88A-CAWE010S             | R88A-CAWE010B §        |
|   | 15 m   | R88A-CAWE015S             | R88A-CAWE015B §        |
|   | 20 m   | R88A-CAWE020S             | R88A-CAWE020B §        |
|   | 30 m   | R88A-CAWE030S             | R88A-CAWE030B §        |
|   | 40 m   | R88A-CAWE040S             | R88A-CAWE040B §        |
|   | 50 m   | R88A-CAWE050S             | R88A-CAWE050B §        |
| 7.5 to 11 kW Cylindrical style servo motors (1,500 RPM)<br>5.5 kW Cylindrical style servo motors (1,000RPM)   | 3 m    | R88A-CAWF003S             | R88A-CAWF003B §        |
|   | 5 m    | R88A-CAWF005S             | R88A-CAWF005B §        |
|   | 10 m   | R88A-CAWF010S             | R88A-CAWF010B §        |
|   | 15 m   | R88A-CAWF015S             | R88A-CAWF015B §        |
|   | 20 m   | R88A-CAWF020S             | R88A-CAWF020B §        |
|   | 30 m   | R88A-CAWF030S             | R88A-CAWF030B §        |
|   | 40 m   | R88A-CAWF040S             | R88A-CAWF040B §        |
|   | 50 m   | R88A-CAWF050S             | R88A-CAWF050B §        |

§ For these motors with brake, a cable for power is required in addition to the brake cable. (Example, for servo motor model R88M-W5K515T-BS2, order both R88A-CAWE015S power cable and R88A-CAWE015B brake cable.)

Note: For 15kW Cylindrical style servomotors (1,500 RPM) use cable AWG4 x 4C UL62, with max. length 50 m and connectors plug MS3108B32-17S with cable plug MS3102A32-17P.

## ② Encoder Cables

| Applicable servo motors  | Length | Model         |
|--|--------|---------------|
| 30-W to 750-W Cylindrical-style motors (3,000 RPM)<br>100-W to 1.5-kW Flat style Motors (3,000 RPM)  | 3 m    | R88A-CRWA003C |
|  | 5 m    | R88A-CRWA005C |
|  | 10 m   | R88A-CRWA010C |
|  | 15 m   | R88A-CRWA015C |
|  | 20 m   | R88A-CRWA020C |
|  | 30 m   | R88A-CRWA030C |
|  | 40 m   | R88A-CRWA040C |
|  | 50 m   | R88A-CRWA050C |
| 1-kW to 5-kW Cylindrical-style motors (3,000 RPM)<br>300-W to 5.5-kW Cylindrical-style motors (1,000 RPM)<br>450-W to 15.0-kW Cylindrical-style motors (1,500 RPM) | 3 m    | R88A-CRWB003N |
|  | 5 m    | R88A-CRWB005N |
|  | 10 m   | R88A-CRWB010N |
|  | 15 m   | R88A-CRWB015N |
|  | 20 m   | R88A-CRWB020N |
|  | 30 m   | R88A-CRWB030N |
|  | 40 m   | R88A-CRWB040N |
|  | 50 m   | R88A-CRWB050N |

## Cables and Accessories

| Application   | Description  | Length        | Model         |
|---|--|---------------|---------------|
| ③ Cables for Motion Control modules   | Control cables for 1 axis (common to CS1, C200H, and CV-Series Controllers)  | 1 m           | R88A-CPW001M1 |
|   |  | 2 m           | R88A-CPW002M1 |
|   |  | 3 m           | R88A-CPW003M1 |
|   |  | 5 m           | R88A-CPW005M1 |
|   | Control cables for 2 axes (common to SYSMAC CS1, C200H, and CV-Series controllers)                                       | 1 m           | R88A-CPW001M2 |
|   |  | 2 m           | R88A-CPW002M2 |
|   |  | 3 m           | R88A-CPW003M2 |
|   |  | 5 m           | R88A-CPW005M2 |
| ④ Servo relay units connect cables from PLC position controller and servo drive | 1-axis Position Control Unit (CS1W-NC113/133, CJ1W-NC113/133); does not support communications functions                 | —             | XW2B-20J6-1B  |
|   | 2-axis Position Control Unit (CS1W-NC213/233/413/433, CJ1W-NC213/233/413/433); does not support communications functions | —             | XW2B-40J6-2B  |
|   | 1-axis CQM1H-PLB21 and CQM1-CPU43-V1; does not support communications functions  | —             | XW2B-20J6-3B  |
|   | 1-axis CJ1M-CPU22/23; does not support communications functions  | —             | XW2B-20J6-8A  |
|   | 2-axis CJ1M-CPU22/23; does not support communications functions  | —             | XW2B-40J6-9A  |
| ⑤ Servo drive connecting cable  | Connects Servo Relay Units XW2B-20J6-1B, XW2B-40J6-2B, XW2B-20J6-3B, XW2B-20J6-8A, or XW2B-40J6-9A                       | 1 m           | XW2Z-100J-B4  |
|   |  | 2 m           | XW2Z-200J-B4  |
|   | Connects Servo Relay Unit XW2B-40J6-4A   | 1 m           | XW2Z-100J-B8  |
|   |  | 2 m           | XW2Z-200J-B8  |
| ⑥ Position controller PLC module cable  | CQM1H-PLB21 and CQM1-CPU43-V1 to XW2B-20J6-3B servo relay unit   | 1 m           | XW2Z-100J-A3  |
|   | CJ1W-NC113 to XW2B-20J6-1B servo relay unit  | 1 m           | XW2Z-100J-A16 |
|   | CJ1W-NC213 or CJ1W-NC413 to XW2B-20J6-2B servo relay unit  | 1 m           | XW2Z-100J-A17 |
|   | CJ1W-NC133 to XW2B-20J6-1B servo relay unit  | 1 m           | XW2Z-100J-A20 |
|   | CJ1W-NC233 or CJ1W-NC433 to XW2B-40J6-2B servo relay unit  | 1 m           | XW2Z-100J-A21 |
|   | CJ1M-CPU22 or CJ1M-CPU23 to XW2B-20J6-8A (1 axis) or XW2B-40J6-9A (2 axes) servo relay unit                              | 1 m           | XW2Z-100J-A26 |
|   | CS1W-NC113 to XW2B-20J6-1B servo relay unit  | 1 m           | XW2Z-100J-A8  |
|   | CS1W-NC213 or CS1W-NC413 to XW2B-40J6-2B servo relay unit  | 1 m           | XW2Z-100J-A9  |
|   | CS1W-NC133 to XW2B-20J6-B1 servo relay unit  | 1 m           | XW2Z-100J-A12 |
| CS1W-NC233 or CS1W-NC433 to XW2B-40J6-2B servo relay unit                       | 1 m  | XW2Z-100J-A13 |               |
| ⑦ General purpose controller cables   | Control cables with connector at one end   | 1 m           | R88A-CPW001S  |
|   |  | 2 m           | R88A-CPW002S  |

## Cables and Accessories (Continued)

| Application                      | Description  | Length        | Model         |
|----------------------------------|--|---------------|---------------|
| ⑧ Universal terminal block cable | Cables for universal terminal block XW2B-50G5  | 1 m           | R88A-CTW001N  |
|                                  |  | 2 m           | R88A-CTW002N  |
|                                  | Control I/O connector; fits port CN1 (WT-series only)                                      | —             | R88A-CNU11C   |
|                                  | Control I/O connector; fits port CN1 (WN-series only)                                      | —             | R88A-CNW01C   |
|                                  | Universal terminal block   | —             | XW2B-50G5     |
|                                  | Cable from relay terminal block XW2B-20G4/XW2B-20G5/XW2D-20G6 to WN-series servo drive CN1 | 1 m           | XW2Z-100J-B16 |
|                                  |  | 2 m           | XW2Z-200J-B16 |
|                                  | Cable from relay terminal block XW2B-20G4/XW2B-20G5/XW2D-20G6 to WT-series servo drive CN1 | 1 m           | XW2Z-100J-B15 |
|                                  | 2 m  | XW2Z-200J-B15 |               |
| ⑨ Battery backup                 | Servo drives R88D-WT50H or less  | —             | R88A-BAT01W   |
|                                  | Servo drives R88D-WT60H/75H/150H   | —             | R88A-BAT02W   |
|                                  | Servo drives R88D-WN, all models (connected in series with encoder cables in ②)            | 0.3 m         | R88A-CRWC0R3C |
| ⑩ Analog monitor cable           | Peripheral cable for analog monitoring; servo drive to PC; connects to port CN4            | 1 m           | R88A-CMW001S  |
| ⑪ Parameter unit                 | Panel mount unit sets and displays servo drive parameters; includes cable                  | 1 m           | R88A-PR02W    |
| ⑫ Personal computer cable        | Connects a personal computer for monitoring; servo drive to PC; connects to port CN3       | 2 m           | R88A-CCW002P2 |

## External Regenerative Resistors

| Rating       | Model         |
|--------------|---------------|
| 220 W 47 Ω   | R88A-RR22047S |
| 880 W 6.25 Ω | R88A-RR88006* |

\* Resistor required for use with Servo Driver models R88D-WT60H/WT75H/WT150H.

## DC Reactors

| Applicable servo drive        | Model       |
|-------------------------------|-------------|
| For R88D-WT30H                | R88A-PX5059 |
| For R88D-WT15H/WT20H          | R88A-PX5060 |
| For R88D-WT05H/WT08H/WT10H    | R88A-PX5061 |
| For R88D-WT02HL               | R88A-PX5062 |
| For R88D-WTA3HL/WTA5HL/WT01HL | R88A-PX5063 |
| For R88D-WT50H                | R88A-PX5068 |
| For R88D-WT04H                | R88A-PX5069 |
| For R88D-WT02H                | R88A-PX5070 |
| For R88D-WTA3H/WTA5H/WT01H    | R88A-PX5071 |

## AC Reactors

| Applicable servo drive                   | Model         |
|--|---------------|
| For R88D-WTA3HL to WT01HL/WD30H to WD02H | R88A-F1W104-E |
| For R88D-WT02HL/WT04H                    | R88A-F1W107-E |
| For R88D-WT05H/WT08H                     | R88A-F1W115-E |
| For R88D-WT10H                           | R88A-F1W125-E |
| For R88D-WT15H/WT20H                     | LF-315K       |
| For R88D-WT30H                           | LF-325K       |
| For R88D-WT50H                           | LF-335K       |
| For R88D-WT60H                           | LF-380K       |

## Network Communication Adapters

**DeviceNet Option Unit** mounts to a W-Series AC Servo drives and performs both DeviceNet communications functions and Position Control Unit functions. Parameters can be set, the operating status can be monitored, and faults can be predicted from a PLC up to 500 m away.

- **Trace Function:** When trigger conditions are satisfied, up to two analog elements and two ON/OFF elements can be recorded in the DeviceNet Option Unit and read from the PLC.
- **Monitor Item Reading Function:** The contents of AC Servo drive monitor display can be read from the PLC.
- **Batch Handling of Operating Information** for Servo Systems Information that can be displayed at W-series AC Servo Drivers using monitor functions (e.g., speed commands and speed feedback) can be read by a PLC using remote I/O functions.

| Description  | Model           |
|--|-----------------|
| DeviceNet Option Unit                                      | R88A-NCW152-DRT |
| External I/O Connector                                     | R88A-CNU01R     |
| Cable for Setup Tool (IBM PC/AT or compatible; 2 m length) | R88A-CCW002P4   |

## MECHATROLINK-II Interface Unit for WT-Series Drives

| Description                          | Cable length | Model        |
|--------------------------------------|--------------|--------------|
| MECHATROLINK-II Interface Unit       | —            | FNY-NS115    |
| MECHATROLINK-II cable                | 0.5 m        | FNY-W6003-A5 |
|                                      | 1 m          | FNY-W6003-01 |
|                                      | 3 m          | FNY-W6003-03 |
|                                      | 5 m          | FNY-W6003-05 |
|                                      | 10 m         | FNY-W6003-10 |
|                                      | 20 m         | FNY-W6003-20 |
|                                      | 30 m         | FNY-W6003-30 |
| MECHATROLINK-II terminating resistor | —            | FNY-W6022    |

# Servos SmartStep



## Cost-Effective Servo Capability with Stepper Simplicity

Easily migrate from steppers to the higher precision of servos in minutes with Omron's SmartStep servo drivers and ultra-compact 3-phase servo motors. They accept pulse-train input that can be configured quickly via simple DIP switches and have an on-line auto-tuning function. SmartStep offers all the simplicity and cost-effectiveness of a stepper with the added advantages of the servo drive capability.

### Motor Features

- Sizes 30 W to 750 W, rated speed 3,000 rpm
- Accepts incremental encoder input at 2,000 p/r
- Cylindrical and flat type servo motors available
- Peak torque up to three times continuous torque during 3 seconds
- Easy to install with pre-built cables
- Motors with brake are available

### Driver Features

- Output range from 30 W to 750 W
- 300% peak current over nominal
- Control via pulse train (speed and position)



- Four position resolution settings:
  - 500 pulses/rotation (0.72°/step)
  - 1,000 pulses/rotation (0.36°/step)
  - 5,000 pulses/rotation (0.072°/step)
  - 10,000 pulses/rotation (0.036°/step)
- SmartStep does not require the use of PC configuration software, making setup as easy as using a stepper motor for basic capabilities
- To optimize performance, use PC software for on-line auto-tuning of values and monitoring

## Ordering Information

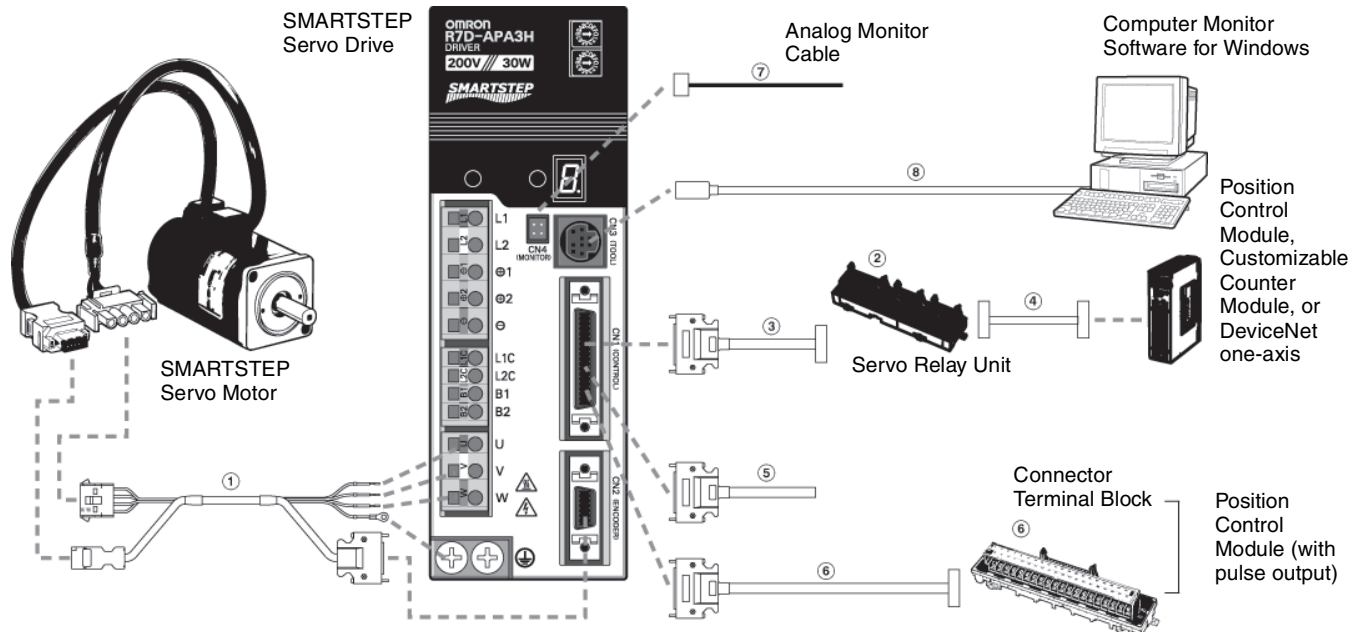

Add cable length to the part number in place of □□□: 003 for 3 m cable, 005 for 5 m, 010 for 10 m, 015 for 15 m and 020 for 20 m.

Note: Circled numbers refer to the configuration diagram on page I-8.

## SmartStep Servos

| Wattage   | Servo motor model | Servo drive model | ① Power cable/Encoder cable model<br>(Add cable length for □□□) |
|---|-------------------|-------------------|---|
| <b>Cylindrical Servo Motors 100 VAC Without Brake, Shaft Without Keyway</b> |                   |                   |   |
| 30 W  | R7M-A03030-S1     | R7D-APA3L         | R7A-CEA□□□S   |
| 50 W  | R7M-A05030-S1     | R7D-APA5L         | R7A-CEA□□□S   |
| 100 W   | R7M-A10030-S1     | R7D-AP01L         | R7A-CEA□□□S   |
| 200 W   | R7M-A20030-S1     | R7D-AP02L         | R7A-CEA□□□S   |
| 400 W   | R7M-A40030-S1     | R7D-AP04L         | R7A-CEA□□□S   |
| <b>Cylindrical Servo Motors 100 VAC With Brake, Shaft With Keyway</b>       |                   |                   |   |
| 30 W  | R7M-A03030-BS1    | R7D-APA3L         | R7A-CEA□□□B   |
| 50 W  | R7M-A05030-BS1    | R7D-APA5L         | R7A-CEA□□□B   |
| 100 W   | R7M-A10030-BS1    | R7D-AP01L         | R7A-CEA□□□B   |
| 200 W   | R7M-A20030-BS1    | R7D-AP02L         | R7A-CEA□□□B   |
| 400 W   | R7M-A40030-BS1    | R7D-AP04L         | R7A-CEA□□□B   |
| <b>Cylindrical Servo Motors 200 VAC Without Brake, Shaft With Keyway</b>    |                   |                   |   |
| 30 W  | R7M-A03030-S1     | R7D-APA3H         | R7A-CEA□□□S   |
| 50 W  | R7M-A05030-S1     | R7D-APA5H         | R7A-CEA□□□S   |
| 100 W   | R7M-A10030-S1     | R7D-AP01H         | R7A-CEA□□□S   |
| 200 W   | R7M-A20030-S1     | R7D-AP02H         | R7A-CEA□□□S   |
| 400 W   | R7M-A40030-S1     | R7D-AP04H         | R7A-CEA□□□S   |
| 750 W   | R7M-A75030-S1     | R7D-AP08H         | R7A-CEA□□□S   |
| <b>Cylindrical Servo Motors 200 VAC With Brake, Shaft With Keyway</b>       |                   |                   |   |
| 30 W  | R7M-A03030-BS1    | R7D-APA3H         | R7A-CEA□□□B   |
| 50 W  | R7M-A05030-BS1    | R7D-APA5H         | R7A-CEA□□□B   |
| 100 W   | R7M-A10030-BS1    | R7D-AP01H         | R7A-CEA□□□B   |
| 200 W   | R7M-A20030-BS1    | R7D-AP02H         | R7A-CEA□□□B   |
| 400 W   | R7M-A40030-BS1    | R7D-AP04H         | R7A-CEA□□□B   |
| 750 W   | R7M-A75030-BS1    | R7D-AP08H         | R7A-CEA□□□B   |
| <b>Flat Servo Motors 100 VAC Without Brake, Shaft With Keyway</b>           |                   |                   |   |
| 100 W   | R7M-AP10030-S1    | R7D-AP01L         | R7A-CEA□□□S   |
| 200 W   | R7M-AP20030-S1    | R7D-AP02L         | R7A-CEA□□□S   |
| 400 W   | R7M-AP40030-S1    | R7D-AP04L         | R7A-CEA□□□S   |
| <b>Flat Servo Motors 100 VAC With Brake, Shaft With Keyway</b>              |                   |                   |   |
| 100 W   | R7M-AP10030-BS1   | R7D-AP01L         | R7A-CEA□□□B   |
| 200 W   | R7M-AP20030-BS1   | R7D-AP02L         | R7A-CEA□□□B   |
| 400 W   | R7M-AP40030-BS1   | R7D-AP04L         | R7A-CEA□□□B   |
| <b>Flat Servo Motors 200 VAC Without Brake, Shaft With Keyway</b>           |                   |                   |   |
| 100 W   | R7M-AP10030-S1    | R7D-AP01H         | R7A-CEA□□□S   |
| 200 W   | R7M-AP20030-S1    | R7D-AP02H         | R7A-CEA□□□S   |
| 400 W   | R7M-AP40030-S1    | R7D-AP04H         | R7A-CEA□□□S   |
| 750 W   | R7M-AP75030-S1    | R7D-AP08H         | R7A-CEA□□□S   |
| <b>Flat Servo Motors 200 VAC With Brake, Shaft With Keyway</b>              |                   |                   |   |
| 100 W   | R7M-AP10030-BS1   | R7D-AP01H         | R7A-CEA□□□B   |
| 200 W   | R7M-AP20030-BS1   | R7D-AP02H         | R7A-CEA□□□B   |
| 400 W   | R7M-AP40030-BS1   | R7D-AP04H         | R7A-CEA□□□B   |
| 750 W   | R7M-AP75030-BS1   | R7D-AP08H         | R7A-CEA□□□B   |



## Cables and Accessories

| Description   | Devices connected  | Specification              | Model         |
|---|--|----------------------------|---------------|
| ② Servo relay units connect cables from PLC position controller and servo drive | CS1W-NC113/133, CJ1W-NC113/133; 1 axis; does not support communications functions                  | —                          | XW2B-20J6-1B  |
|   | CS1W-NC213/233/413/433, CJ1W-NC213/233/413/433; 2 axes; does not support communications functions  | —                          | XW2B-40J6-2B  |
|   | CQM1H-PLB21 and CQM1-CPU43-V1; 1 axis; does not support communications functions                   | —                          | XW2B-20J6-3B  |
|   | CS1W-NC213/233/413/433, CJ1W-NC213/233/413/433; 2 axes; supports communications functions          | —                          | XW2B-40J6-4A  |
|   | CJ1M-CPU22/23; 1 axis; does not support communications functions                                   | —                          | XW2B-20J6-8A  |
|   | CJ1M-CPU22/23; 2 axes; does not support communications functions                                   | —                          | XW2B-40J6-9A  |
| ③ Universal terminal block cable to servo drive                                 | Doesn't support communications functions.<br>(For the XW2B-□□J6-□B)                                | 1 m length                 | XW2Z-100J-B5  |
|   |  | 2 m length                 | XW2Z-200J-B5  |
| ④ Position controller PLC module cable  | CQM1H-PLB21 and CQM1-CPU43-V1 to XW2B-20J6-3B servo relay unit                                     | 1 m length                 | XW2Z-100J-A3  |
|   | CJ1W-NC113 to XW2B-20J6-1B servo relay unit  | 1 m length                 | XW2Z-100J-A16 |
|   | CJ1W-NC213 or CJ1W-NC413 to XW2B-20J6-2B servo relay unit  | 1 m length                 | XW2Z-100J-A17 |
|   | CJ1W-NC133 to XW2B-20J6-1B servo relay unit  | 1 m length                 | XW2Z-100J-A20 |
|   | CJ1W-NC233 or CJ1W-NC433 to XW2B-40J6-2B servo relay unit  | 1 m length                 | XW2Z-100J-A21 |
|   | CJ1M-CPU22 or CJ1M-CPU23 to XW2B-20J6-8A (1 axis) or XW2B-40J6-9A (2 axes) servo relay unit        | 1 m length                 | XW2Z-100J-A26 |
|   | CS1W-NC113 to XW2B-20J6-1B servo relay unit  | 1 m length                 | XW2Z-100J-A8  |
|   | CS1W-NC213 or CS1W-NC413 to XW2B-40J6-2B servo relay unit  | 1 m length                 | XW2Z-100J-A9  |
|   | CS1W-NC133 to XW2B-20J6-B1 servo relay unit  | 1 m length                 | XW2Z-100J-A12 |
|   | CS1W-NC233 or CS1W-NC433 to XW2B-40J6-2B servo relay unit  | 1 m length                 | XW2Z-100J-A13 |
| ⑤ Control cable   | For general-purpose Controllers (mating connector for CJ1 on one end, open ended on the other end) | 1 m length                 | R88A-CPU001S  |
|   |  | 2 m length                 | R88A-CPU002S  |
| ⑥ Universal terminal block  | For position control modules with pulse output and general-purpose controllers                     | —                          | XW2B-40F5-P   |
|   | Connector cable between terminal block and servo driver  | 1 m length                 | R88A-CTU001N  |
|   |  | 2 m length                 | R88A-CTU002N  |
| ⑦ Analog monitor cable (port CN4)   | Servo drive to PC  | 1 m length                 | R88A-CMW001S  |
| ⑧ Computer monitor cable (port CN3)   | Servo drive to PC  | 2 m length                 | R7A-CCA002P2  |
| Filters   | For servo drive R7D-APA3H, APA5H, AP01H, AP02H; R7D-APA3L, APA5L, AP01L, AP02L                     | 4 A, 250 VAC single phase  | R88A-FIW104-E |
|   | For servo drive R7D-AP04H, AP04L   | 7 A, 250 VAC single phase  | R88A-FIW107-E |
|   | For servo drive R7D-AP08H  | 15 A, 250 VAC single phase | R88A-FIW115-E |
| Control I/O connector (CN1)   | —  | —                          | R88A-CNU01C   |
| SmartStep encoder connector (CN2)   | —  | —                          | R7A-CNA01R    |
| External regeneration resistor  | —  | 200 W, 47 Ω                | R88A-RR22047S |
| Parameter copy unit with cable  | —  | —                          | R7A-PR02A     |
| Configuration and monitoring software   | For servo drives and inverters   | Version 1.11 or higher     | CX-DRIVE      |
| Complete OMRON software suite   | Includes CX-Drive  | —                          | CX-ONE        |

## Specifications

### Servo Drives General Specifications

| Item                         | Specification   |
|------------------------------|---|
| Operating ambient            | 0° to 55° C (32° F to 131° F), 90% RH max. (with no condensation)   |
| Storage ambient              | -20° to 85° C (-4° F to 185° F), 90% RH max. (with no condensation)   |
| Storage/operating atmosphere | No corrosive gases.   |
| Vibration resistance         | 10 to 55 Hz in X, Y, and Z directions with 0.1-mm double amplitude or acceleration of 4.9 m/s <sup>2</sup> max., whichever is smaller |
| Impact resistance            | Acceleration 19.6 m/s <sup>2</sup> max., in X, Y, and Z directions, three times   |
| Insulation resistance        | Between power line terminals and case: 0.5 MΩ min. (at 500 VDC)   |
| Dielectric strength          | Between power line terminals and case: 1,500 VAC for 1 min. at 50/60 Hz between each control signal and case: 500 VAC for 1 min.      |
| Protective structure         | Built into panel (IP10).  |
| International standards      | Approval obtained for UL, cUL, and EN (EMC directive and low-voltage directive)   |

### Servo Drives Performance Specifications

#### 100 VAC Input Models

| Item                                   | Specification  |            |            |            |            |
|--|--|------------|------------|------------|------------|
| Model                                  | R7D-APA3L  | R7D-APA5L  | R7D-AP01L  | R7D-AP02L  | R7D-AP04L  |
| Rated output                           | 30 W   | 50 W       | 100 W      | 200 W      | 400 W      |
| Continuous output current (rms)        | 0.42   | 0.6        | 0.89       | 2.0        | 2.6        |
| Momentary maximum output current (rms) | 1.3  | 1.9        | 2.8        | 6.0        | 8.0        |
| Control power supply                   | Single-phase 100/115 VAC (85 to 127 V) 50/60 Hz                          |            |            |            |            |
| Main-circuit power supply              | Single-phase 100/115 VAC (85 to 127 V) 50/60 Hz (Voltage doubler method) |            |            |            |            |
| Control method                         | All-digital servo  |            |            |            |            |
| Speed feedback                         | 2,000 pulses/revolution Incremental Encoder                              |            |            |            |            |
| Inverter method                        | PWM method based on IGBT   |            |            |            |            |
| PWM frequency                          | 11.7 kHz   |            |            |            |            |
| Weight [kg (lb)]                       | 0.8 (1.76)   | 0.8 (1.76) | 0.8 (1.76) | 0.8 (1.76) | 1.1 (2.43) |
| Compatible motor voltage               | 200 V  |            |            |            |            |
| Compatible motor capacity              | 30 W   | 50 W       | 100 W      | 200 W      | 400 W      |
| Command pulse response                 | 250 kHz  |            |            |            |            |
| Applicable servo motor (R7M-)          | A03030_  | A05030_    | A10030_    | A20030_    | A40030_    |
|  | —  | —          | AP10030_   | AP20030_   | AP40030_   |

#### 200 VAC Input Models

| Item                                   | Specification  |            |            |            |            |            |
|--|--|------------|------------|------------|------------|------------|
| Model                                  | R7D-APA3H  | R7D-APA5H  | R7D-AP01H  | R7D-AP02H  | R7D-AP04H  | R7D-AP08H  |
| Rated output                           | 30 W   | 50 W       | 100 W      | 200 W      | 400 W      | 750 W      |
| Continuous output current (rms)        | 0.42   | 0.6        | 0.89       | 2.0        | 2.6        | 4.4        |
| Momentary maximum output current (rms) | 1.3  | 1.9        | 2.8        | 6.0        | 8.0        | 13.9       |
| Control power supply                   | Single-phase 200/230 VAC (170 to 253 V) 50/60 Hz   |            |            |            |            |            |
| Main-circuit power supply              | Single-phase 200/230 VAC (170 to 253 V) 50/60 Hz<br>(Three-phase 200/230 VAC can be used with the 750 W model) |            |            |            |            |            |
| Control method                         | All-digital servo  |            |            |            |            |            |
| Speed feedback                         | 2,000 pulses/revolution incremental encoder  |            |            |            |            |            |
| Inverter method                        | PWM method based on IGBT   |            |            |            |            |            |
| PWM frequency                          | 11.7 kHz   |            |            |            |            |            |
| Weight [kg (lb)]                       | 0.8 (1.76)   | 0.8 (1.76) | 0.8 (1.76) | 0.8 (1.76) | 1.1 (2.43) | 1.7 (3.75) |
| Servo motor voltage                    | 200 V  |            |            |            |            |            |
| Servo motor capacity                   | 30 W   | 50 W       | 100 W      | 200 W      | 400 W      | 750 W      |
| Command pulse response                 | 250 kHz  |            |            |            |            |            |
| Applicable servo motor (R7M-)          | A03030   | A05030     | A10030     | A20030     | A40030     | A75030     |
|  | —  | —          | AP10030    | AP20030    | AP40030    | AP75030    |



## Servo Motor General Specifications

| Item                         | Specification   |
|------------------------------|---|
| Operating ambient            | 0°C to 40°C (32°F to 104°F), 20% to 80% RH (with no condensation)   |
| Storage ambient              | -20°C to 60°C (-4°F to 140°F), 20% to 80% RH (with no condensation)   |
| Storage/operating atmosphere | No corrosive gases  |
| Vibration resistance         | 10 to 2,500 Hz in X, Y, and Z directions with 0.2 mm double amplitude or acceleration of 24.5 m/s <sup>2</sup> max., whichever is smaller |
| Impact resistance            | Acceleration 98 m/s <sup>2</sup> max., in a vertical direction, two times   |
| Insulation resistance        | Between power line terminals and FG: 10 MΩ min. (at 500 VDC)  |
| Dielectric strength          | Between power line terminals and FG: 1,500 V AC for 1 min at 50/60 Hz   |
| Run position                 | Any direction   |
| Insulation grade             | Type B  |
| Structure                    | Totally-enclosed self-cooling   |
| Protective structure         | IP55 for both the cylindrical and flat servo motors   |
| Vibration grade              | V-15  |
| Mounting method              | Flange-mounting   |
| International standards      | Approval obtained for UL, cUL, and EN (EMC directive and low-voltage directive)   |

## Servo Motor Performance Specifications

### Flat Servo Motors without Brakes

| Item                             | R7M-AP10030-S1  | R7M-AP20030-S1                            | R7M-AP40030-S1                            | R7M-AP75030-S1                            |
|----------------------------------|---|---|---|---|
| Rated output                     | 100 W   | 200 W                                     | 400 W                                     | 750 W                                     |
| Rated torque                     | 0.318 N•m   | 0.637 N•m                                 | 1.27 N•m                                  | 2.39 N•m                                  |
| Rated rotation speed             | 3,000 r/min.  | 3,000 r/min.                              | 3,000 r/min.                              | 3,000 r/min.                              |
| Momentary maximum rotation speed | 4,500 r/min.  | 4,500 r/min.                              | 4,500 r/min.                              | 4,500 r/min.                              |
| Momentary maximum torque         | 0.96 N•m  | 1.91 N•m                                  | 3.82 N•m                                  | 7.1 N•m                                   |
| Rated current                    | 0.89 A (rms)  | 2.0 A (rms)                               | 2.6 A (rms)                               | 4.1 A (rms)                               |
| Momentary maximum current        | 2.8 A (rms)   | 6.0 A (rms)                               | 8.0 A (rms)                               | 13.9 A (rms)                              |
| Rotor inertia                    | 6.5 × 10 <sup>-6</sup> kg•m <sup>2</sup>  | 2.09 × 10 <sup>-5</sup> kg•m <sup>2</sup> | 3.47 × 10 <sup>-5</sup> kg•m <sup>2</sup> | 2.11 × 10 <sup>-4</sup> kg•m <sup>2</sup> |
| Power rate                       | 15.7 kW/s   | 19.4 kW/s                                 | 46.8 kW/s                                 | 26.9 kW/s                                 |
| Allowable radial load            | 78 N  | 245 N                                     | 245 N                                     | 392 N                                     |
| Allowable thrust load            | 49 N  | 68 N                                      | 68 N                                      | 147 N                                     |
| Weight (without brake -S1)       | 0.7 kg  | 1.4 kg                                    | 2.1 kg                                    | 4.2 kg                                    |
| Applicable servo driver          | R7D-AP01H/L   | R7D-AP02H/L                               | R7D-AP04H/L                               | R7D-AP08H                                 |
| Encoder resolution               | 2,000 pulses/revolution for phase-A and phase-B, 1 pulse/revolution for phase-Z |   |   |   |
| Radiation shield dimensions      | t6 x250 mm square   |   |   | t12 x300 mm square                        |

### Flat Servo Motors with Brakes

| Item                             | R7M-AP10030-BS1   | R7M-AP20030-BS1                           | R7M-AP40030-BS1                           | R7M-AP75030-BS1                           |   |
|----------------------------------|---|---|---|---|---|
| Rated output                     | 100 W   | 200 W                                     | 400 W                                     | 750 W                                     |   |
| Rated torque                     | 0.318 N•m   | 0.637 N•m                                 | 1.27 N•m                                  | 2.39 N•m                                  |   |
| Rated rotation speed             | 3,000 r/min.  | 3,000 r/min.                              | 3,000 r/min.                              | 3,000 r/min.                              |   |
| Momentary maximum rotation speed | 4,500 r/min.  | 4,500 r/min.                              | 4,500 r/min.                              | 4,500 r/min.                              |   |
| Momentary maximum torque         | 0.96 N•m  | 1.91 N•m                                  | 3.82 N•m                                  | 7.1 N•m                                   |   |
| Rated current                    | 0.89 A (rms)  | 2.0 A (rms)                               | 2.6 A (rms)                               | 4.1 A (rms)                               |   |
| Momentary maximum current        | 2.8 A (rms)   | 6.0 A (rms)                               | 8.0 A (rms)                               | 13.9 A (rms)                              |   |
| Rotor inertia                    | 6.5 × 10 <sup>-6</sup> kg•m <sup>2</sup>  | 2.09 × 10 <sup>-5</sup> kg•m <sup>2</sup> | 3.47 × 10 <sup>-5</sup> kg•m <sup>2</sup> | 2.11 × 10 <sup>-4</sup> kg•m <sup>2</sup> |   |
| Power rate                       | 15.7 kW/s   | 19.4 kW/s                                 | 46.8 kW/s                                 | 26.9 kW/s                                 |   |
| Allowable radial load            | 78 N  | 245 N                                     | 245 N                                     | 392 N                                     |   |
| Allowable thrust load            | 49 N  | 68 N                                      | 68 N                                      | 147 N                                     |   |
| Weight (with brake -BS1)         | 0.9 kg  | 1.9 kg                                    | 2.6 kg                                    | 5.7 kg                                    |   |
| Applicable servo driver          | R7D-AP01H/L   | R7D-AP02H/L                               | R7D-AP04H/L                               | R7D-AP08H                                 |   |
| Encoder resolution               | 2,000 pulses/revolution for phase-A and phase-B, 1 pulse/revolution for phase-Z |   |   |   |   |
| Radiation shield dimensions      | t6 x250 mm square   |   |   | t12 x300 mm square                        |   |
| Brake specifications             | Brake inertia   | 3.1 × 10 <sup>-6</sup> kg•m <sup>2</sup>  | 1.52 × 10 <sup>-5</sup> kg•m <sup>2</sup> | 1.52 × 10 <sup>-5</sup> kg•m <sup>2</sup> | 8.75 × 10 <sup>-5</sup> kg•m <sup>2</sup> |
|                                  | Excitation voltage  | 24 V DC ±10%                              |   |   |   |
|                                  | Power consumption (at 20°C)   | 6 W                                       | 5 W                                       | 7.6 W                                     | 7.5 W                                     |
|                                  | Current consumption (at 20°C)   | 0.25 A                                    | 0.21 A                                    | 0.32 A                                    | 0.31 A                                    |
|                                  | Static friction torque  | 0.4 N•m min.                              | 0.9 N•m min.                              | 1.9 N•m min.                              | 3.5 N•m min.                              |
|                                  | Attraction time   | 40 ms max.                                | 40 ms max.                                | 40 ms max.                                | 40 ms max.                                |
|                                  | Release time  | 20 ms max.                                | 20 ms max.                                | 20 ms max.                                | 20 ms max.                                |
|                                  | Backlash  | 1°  |   |   |   |
| Rating                           | Continuous  |   |   |   |   |
| Insulation grade                 | Type F  |   |   |   |   |

Cylindrical Servo Motors without Brakes

| Item                             | R7M-A03030-S1   | R7M-A05030-S1                                  | R7M-A10030-S1                                  | R7M-A20030-S1                                   | R7M-A40030-S1                                   | R7M-A75030-S1                                   |
|----------------------------------|---|--|--|---|---|---|
| Rated output                     | 30 W  | 50 W   | 100 W  | 200 W   | 400 W   | 750 W   |
| Rated torque                     | 0.095 N•m   | 0.159 N•m                                      | 0.318 N•m                                      | 0.637 N•m                                       | 1.27 N•m  | 2.39 N•m  |
| Rated rotation speed             | 3,000 r/min.  | 3,000 r/min.                                   | 3,000 r/min.                                   | 3,000 r/min.                                    | 3,000 r/min.                                    | 3,000 r/min.                                    |
| Momentary maximum rotation speed | 4,500 r/min.  | 4,500 r/min.                                   | 4,500 r/min.                                   | 4,500 r/min.                                    | 4,500 r/min.                                    | 4,500 r/min.                                    |
| Momentary maximum torque         | 0.29 N•m  | 0.48 N•m                                       | 0.96 N•m                                       | 1.91 N•m  | 3.82 N•m  | 7.1 N•m   |
| Rated current (rms)              | 0.42 A  | 0.6 A  | 0.87 A   | 2.0 A   | 2.6 A   | 4.4 A   |
| Momentary maximum current (rms)  | 1.3 A   | 1.9 A  | 2.8 A  | 6.0 A   | 8.0 A   | 13.9 A  |
| Rotor inertia                    | $1.7 \times 10^{-6} \text{ kg}\cdot\text{m}^2$                                  | $2.2 \times 10^{-6} \text{ kg}\cdot\text{m}^2$ | $3.6 \times 10^{-6} \text{ kg}\cdot\text{m}^2$ | $1.19 \times 10^{-5} \text{ kg}\cdot\text{m}^2$ | $1.87 \times 10^{-5} \text{ kg}\cdot\text{m}^2$ | $6.67 \times 10^{-5} \text{ kg}\cdot\text{m}^2$ |
| Power rate                       | 5.31 kW/s   | 11.5 kW/s                                      | 28.1 kW/s                                      | 34.1 kW/s                                       | 86.3 kW/s                                       | 85.6 kW/s                                       |
| Allowable radial load            | 68 N  | 68 N   | 78 N   | 245 N   | 245 N   | 392 N   |
| Allowable thrust load            | 54 N  | 54 N   | 54 N   | 74 N  | 74 N  | 147 N   |
| Weight without brake             | 0.3 kg  | 0.4 kg   | 0.5 kg   | 1.1 kg  | 1.7 kg  | 3.4 kg  |
| Applicable servo driver          | R7D-APA3H   | R7D-APA5H                                      | R7D-AP01H                                      | R7D-AP02H                                       | R7D-AP04H                                       | R7D-AP08H                                       |
| Encoder resolution               | 2,000 pulses/revolution for phase-A and phase-B, 1 pulse/revolution for phase-Z |  |  |   |   |   |
| Radiation shield dimensions      | t6× 250 mm square   |  |  |   |   |   |

Cylindrical Servo Motors with Brakes

| Item                             | R7M-A03030-BS1  | R7M-A05030-BS1                                  | R7M-A10030-BS1                                  | R7M-A20030-BS1                                  | R7M-A40030-BS1                                  | R7M-A75030-BS1                                  |  |
|----------------------------------|---|---|---|---|---|---|--|
| Rated output                     | 30 W  | 50 W  | 100 W   | 200 W   | 400 W   | 750 W   |  |
| Rated torque                     | 0.095 N•m   | 0.159 N•m                                       | 0.318 N•m                                       | 0.637 N•m                                       | 1.27 N•m  | 2.39 N•m  |  |
| Rated rotation speed             | 3,000 r/min.  | 3,000 r/min.                                    | 3,000 r/min.                                    | 3,000 r/min.                                    | 3,000 r/min.                                    | 3,000 r/min.                                    |  |
| Momentary maximum rotation speed | 4,500 r/min.  | 4,500 r/min.                                    | 4,500 r/min.                                    | 4,500 r/min.                                    | 4,500 r/min.                                    | 4,500 r/min.                                    |  |
| Momentary maximum torque         | 0.29 N•m  | 0.48 N•m  | 0.96 N•m  | 1.91 N•m  | 3.82 N•m  | 7.1 N•m   |  |
| Rated current (rms)              | 0.42 A  | 0.6 A   | 0.87 A  | 2.0 A   | 2.6 A   | 4.4 A   |  |
| Momentary maximum current (rms)  | 1.3 A   | 1.9 A   | 2.8 A   | 6.0 A   | 8.0 A   | 13.9 A  |  |
| Rotor inertia                    | $1.7 \times 10^{-6} \text{ kg}\cdot\text{m}^2$                                  | $2.2 \times 10^{-6} \text{ kg}\cdot\text{m}^2$  | $3.6 \times 10^{-6} \text{ kg}\cdot\text{m}^2$  | $1.19 \times 10^{-5} \text{ kg}\cdot\text{m}^2$ | $1.87 \times 10^{-5} \text{ kg}\cdot\text{m}^2$ | $6.67 \times 10^{-5} \text{ kg}\cdot\text{m}^2$ |  |
| Power rate                       | 5.31 kW/s   | 11.5 kW/s                                       | 28.1 kW/s                                       | 34.1 kW/s                                       | 86.3 kW/s                                       | 85.6 kW/s                                       |  |
| Allowable radial load            | 68 N  | 68 N  | 78 N  | 245 N   | 245 N   | 392 N   |  |
| Allowable thrust load            | 54 N  | 54 N  | 54 N  | 74 N  | 74 N  | 147 N   |  |
| Weight with brake                | 0.6 kg  | 0.7 kg  | 0.8 kg  | 1.6 kg  | 2.2 kg  | 4.3 kg  |  |
| Applicable servo driver          | R7D-APA3H   | R7D-APA5H                                       | R7D-AP01H                                       | R7D-AP02H                                       | R7D-AP04H                                       | R7D-AP08H                                       |  |
| Encoder resolution               | 2,000 pulses/revolution for phase-A and phase-B, 1 pulse/revolution for phase-Z |   |   |   |   |   |  |
| Radiation shield dimensions      | t6× 250 mm square   |   |   |   |   |   |  |
| Brake specifications             | Brake inertia   | $0.85 \times 10^{-6} \text{ kg}\cdot\text{m}^2$ | $0.85 \times 10^{-6} \text{ kg}\cdot\text{m}^2$ | $0.85 \times 10^{-6} \text{ kg}\cdot\text{m}^2$ | $6.4 \times 10^{-6} \text{ kg}\cdot\text{m}^2$  | $6.4 \times 10^{-6} \text{ kg}\cdot\text{m}^2$  | $1.7 \times 10^{-5} \text{ kg}\cdot\text{m}^2$ |
|                                  | Excitation voltage  | 24 V DC ±10% V                                  |   |   |   |   |  |
|                                  | Power consumption (at 20° C)  | 6 W   | 6 W   | 6 W   | 7 W   | 7 W   | 7.7 W  |
|                                  | Current consumption (at 20° C)  | 0.25 A  | 0.25 A  | 0.25 A  | 0.29 A  | 0.29 A  | 0.32 A   |
|                                  | Static friction torque  | 0.2 N•m min.                                    | 0.2 N•m min.                                    | 0.34 N•m min.                                   | 1.47 N•m min.                                   | 1.47 N•m min.                                   | 2.45 N•m min.                                  |
|                                  | Attraction time   | 30 ms max.                                      | 30 ms max.                                      | 30 ms max.                                      | 60 ms max.                                      | 60 ms max.                                      | 60 ms max.                                     |
|                                  | Release time  | 60 ms max.                                      | 60 ms max.                                      | 60 ms max.                                      | 20 ms max.                                      | 20 ms max.                                      | 20 ms max.                                     |
|                                  | Backlash  | 1°  |   |   |   |   |  |
|                                  | Rating  | Continuous                                      |   |   |   |   |  |
| Insulation grade                 | Type F  |   |   |   |   |   |  |

## Dimensions

### Servo Drives Dimensions (mm)

| Input voltage                | Rating | Drive model | H   | W  | D   |
|------------------------------|--------|-------------|-----|----|-----|
| 1-phase, 100 VAC and 200 VAC | 30 W   | R7D-APA3H/L | 160 | 55 | 130 |
|                              | 50 W   | R7D-APA5H/L | 160 | 55 | 130 |
|                              | 100 W  | R7D-AP01H/L | 160 | 55 | 130 |
|                              | 200 W  | R7D-AP02H/L | 160 | 55 | 130 |
|                              | 400 W  | R7D-AP04H/L | 160 | 75 | 130 |
| 1-phase, 200 VAC             | 750 W  | R7D-AP08H   | 160 | 90 | 180 |

### Cylindrical Servo Motors (3,000 r/min) Dimensions (mm)

#### 200 VAC: 30 W/50 W/100 W/200 W/400 W/750 W

Without brake: R7M-A03030-S1-D/A05030-S1-D/A10030-S1-D/A20030-S1-D/A40030-S1-D/A75030-S1-D

With brake: R7M-A03030-BS1-D/A05030-BS1-D/A10030-BS1-D/A20030-BS1-D/A40030-BS1-D/A75030-BS1-D

R7M-A□□□30(-S1) (Without Brake)

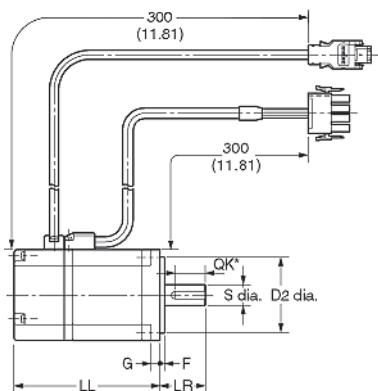

R7M-A□□□30(-S1) (With Brake)

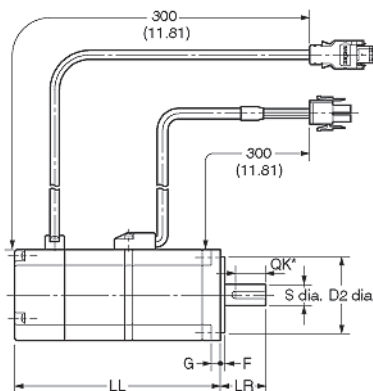

\*Axis End Dimensions

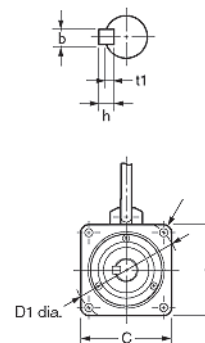

| Model          | Overall length |    | Flange surface |    |      | Axis end |   |                |      |    |   |   |     |
|----------------|----------------|----|----------------|----|------|----------|---|----------------|------|----|---|---|-----|
|                | LL             | LR | C              | D1 | D2   | F        | G | Z              | S    | QK | b | h | t1  |
| R7M-A03030-S1  | 69.5           | 25 | 40             | 46 | 30h7 | 2.5      | 5 | Two, 4.3 dia.  | 6h6  | 14 | 2 | 2 | 1.2 |
| R7M-A03030-BS1 | 101            | 25 | 40             | 46 | 30h7 | 2.5      | 5 | Two, 4.3 dia.  | 6h6  | 14 | 2 | 2 | 1.2 |
| R7M-A05030-S1  | 77             | 25 | 40             | 46 | 30h7 | 2.5      | 5 | Two, 4.3 dia.  | 6h6  | 14 | 2 | 2 | 1.2 |
| R7M-A05030-BS1 | 108.5          | 25 | 40             | 46 | 30h7 | 2.5      | 5 | Two, 4.3 dia.  | 6h6  | 14 | 2 | 2 | 1.2 |
| R7M-A10030-S1  | 94.5           | 25 | 40             | 46 | 30h7 | 2.5      | 5 | Two, 4.3 dia.  | 8h6  | 14 | 3 | 3 | 1.8 |
| R7M-A10030-BS1 | 135            | 25 | 40             | 46 | 30h7 | 2.5      | 5 | Two, 4.3 dia.  | 8h6  | 14 | 3 | 3 | 1.8 |
| R7M-A20030-S1  | 96.5           | 30 | 60             | 70 | 50h7 | 3        | 6 | Four, 5.5 dia. | 14h6 | 20 | 5 | 5 | 3   |
| R7M-A20030-BS1 | 136            | 30 | 60             | 70 | 50h7 | 3        | 6 | Four, 5.5 dia. | 14h6 | 20 | 5 | 5 | 3   |
| R7M-A40030-S1  | 124.5          | 30 | 60             | 70 | 50h7 | 3        | 6 | Four, 5.5 dia. | 14h6 | 20 | 5 | 5 | 3   |
| R7M-A40030-BS1 | 164            | 30 | 60             | 70 | 50h7 | 3        | 6 | Four, 5.5 dia. | 14h6 | 20 | 5 | 5 | 3   |
| R7M-A75030-S1  | 145            | 40 | 80             | 90 | 70h7 | 3        | 8 | Four, 7 dia.   | 16h6 | 30 | 5 | 5 | 3   |
| R7M-A75030-BS1 | 189.5          | 40 | 80             | 90 | 70h7 | 3        | 8 | Four, 7 dia.   | 16h6 | 30 | 5 | 5 | 3   |

# Flat Servo Motors (3,000 r/min) Dimensions (mm)

## 200 VAC: 100 W/200 W/400 W/750 W

Without brake: R7M-AP10030-S1-D/AP20030-S1-D/AP40030-S1-D/AP75030-S1-D

With brake: R7M-AP10030-BS1-D/AP20030-BS1-D/AP40030-BS1-D/AP75030-BS1-D

R7M-AP□□□30(-S1) (Without Brake)

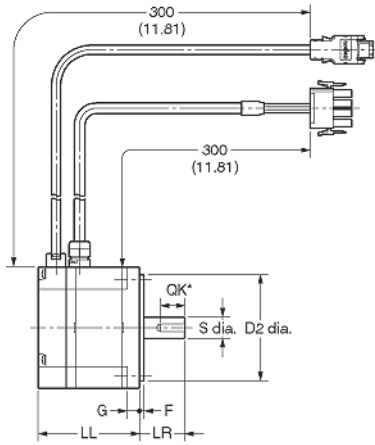

R7M-AP□□□30(-S1) (With Brake)

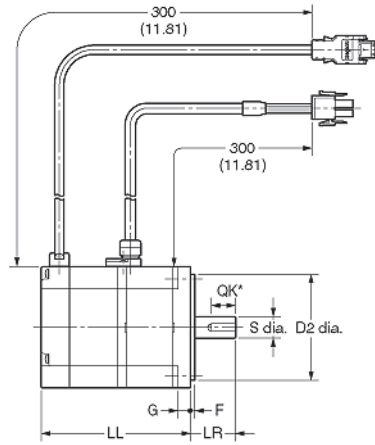

\*Axis End Dimensions

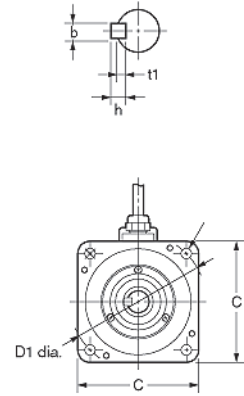

| Model           | Overall length |    | Flange surface |     |       | Axis end |    |          |      |    |   |   |     |
|-----------------|----------------|----|----------------|-----|-------|----------|----|----------|------|----|---|---|-----|
|                 | LL             | LR | C              | D1  | D2    | F        | G  | Z        | S    | QK | b | h | t1  |
| R7M-AP10030-S1  | 62             | 25 | 60             | 70  | 50h7  | 2.5      | 6  | 5.5 dia. | 8h6  | 14 | 3 | 3 | 1.8 |
| R7M-AP10030-BS1 | 91             | 25 | 60             | 70  | 50h7  | 2.5      | 6  | 5.5 dia. | 8h6  | 14 | 3 | 3 | 1.8 |
| R7M-AP20030-S1  | 67             | 30 | 80             | 90  | 70h7  | 3        | 8  | 7 dia.   | 14h6 | 16 | 5 | 5 | 3   |
| R7M-AP20030-BS1 | 98.5           | 30 | 80             | 90  | 70h7  | 3        | 8  | 7 dia.   | 14h6 | 16 | 5 | 5 | 3   |
| R7M-AP40030-S1  | 87             | 30 | 80             | 90  | 70h7  | 3        | 8  | 7 dia.   | 14h6 | 16 | 5 | 5 | 3   |
| R7M-AP40030-BS1 | 118.5          | 30 | 80             | 90  | 70h7  | 3        | 8  | 7 dia.   | 14h6 | 16 | 5 | 5 | 3   |
| R7M-AP75030-S1  | 86.5           | 40 | 120            | 145 | 110h7 | 3.5      | 10 | 10 dia.  | 16h6 | 22 | 5 | 5 | 3   |
| R7M-AP75030-BS1 | 120            | 40 | 120            | 145 | 110h7 | 3.5      | 10 | 10 dia.  | 16h6 | 22 | 5 | 5 | 3   |

# Inverters

# 3G3JV

Quick Link

A031

## Compact AC Inverter for Simple Motor Control

- Easy-to-use digital operator controls all parameter selections and settings
- Quick Start LEDs for quick setup and troubleshooting
- Fine-tune speed using the potentiometer on the digital operator
- Ideal for simple, small motor control applications — uses V/Hz control method
- Programmable output frequency, 400 Hz maximum
- Modbus serial communications
- Compact size: 5.04 H x 5.04 W x 6.34 D inches max. (230 VAC)
  - 5.04 H x 5.51 W x 6.34 D inches max. (460 VAC)



## Specifications

| Power supply                            |  |  |
|---|--|--|
| Rated input voltage & frequency         | 3-phase, 200 to 230 V, 50/60 Hz<br>Single-phase, 200 to 240 V, 50/60 Hz  | 3-phase, 380 to 460 V, 50/60 Hz                          |
| Allowable voltage fluctuation           | -15% to +10%   |  |
| Allowable frequency fluctuation         | ±5%  |  |
| Control characteristics                 |  |  |
| Control method                          | Sine Wave PWM (V/f control), possible to program any V/f pattern   |  |
| Frequency control range                 | 0.1 to 400 Hz  |  |
| Frequency accuracy (temperature change) | Digital reference: ±0.01%, 14 to 122°F (-10 to +50°C)<br>Analog reference: ±0.5%, 59 to 95°F (25±10°C)   |  |
| Frequency setting resolution            | Digital reference: 0.1 Hz (less than 100 Hz)/1 Hz (100 Hz or more)<br>Analog reference: (0:06/60 Hz) equivalent to 1/1000 of max. output frequency             |  |
| Output frequency resolution             | 0.01 Hz  |  |
| Overload capacity                       | 150% rated output current for one minute   |  |
| Frequency setting signal                | 0 to 10 VDC (20 kΩ), 4 to 20 mA (250 Ω), 0 to 20 mA (250 Ω) frequency setting volume (selectable)  |  |
| Accel/Decel                             | 0.1 to 999 sec. (accel./decel. time are independently programmed)  |  |
| Braking torque                          | Short-term average deceleration torque<br>0.13 HP, 0.25 HP: 150%; 0.5 HP, 1 HP: 100%; 2 HP: 50%; 3 HP or more: 20% Continuous regenerative torque: Approx. 20% |  |
| Protective functions                    |  |  |
| Motor overload protection               | UL-recognized electronic thermal overload relay  |  |
| Instantaneous overcurrent               | Motor coasts to a stop at approximately 250% rated output current  |  |
| Overload                                | Motor coasts to a stop after one minute at 150% rated output current<br>Motor coasts to a stop at approximately 200% rated output current                      |  |
| Overvoltage                             | Motor coasts to a stop if DC bus voltage exceed 410 V  | Motor coasts to a stop if DC bus voltage exceeds 820 V   |
| Undervoltage                            | Stops when DC bus voltage is approximately 200 V or less (approx. 160 V or less for single-phase series)   | Stops when DC bus voltage is approximately 400 V or less |
| Momentary power loss                    | Stops if power loss is 15 ms or more. By setting inverter, operation can be continued if power is restored within approximately 0.5 s                          |  |
| Cooling method                          | Cooling fan is provided for: 230 V, 1 HP or larger inverters (3-phase); 460 V, 2 HP or larger inverters (single-phase); other models are self-cooling          |  |
| Cooling fin overheat                    | Protected by electronic circuit  |  |

## Specifications (Continued)

|                                 |   |
|---------------------------------|---|
| Cooling fan fault               | Protected by electronic circuit (fan-stalling detection)  |
| Stall prevention                | Individual levels during acceleration/running, enable/disable provided during deceleration  |
| Ground fault                    | Protected by electronic circuit (rated output current level)  |
| Power charge indication         | RUN lamp stays ON or digital operator LED stays ON. (Charge LED is provided for 460 V) ON until the DC bus voltage becomes 50 V or less   |
| <b>Environmental conditions</b> |   |
| Enclosure rating                | Open chassis: IP20  |
| Location                        | Indoor (free from corrosive gases and dust)   |
| Ambient temperature             | Open chassis: 14 to 122°F (-10 to +50°C), not frozen  |
| Storage temperature             | -4 to 140°F (-20 to 60°C)   |
| Humidity                        | 95% RH (Non-condensing)   |
| Elevation                       | 1,000 m (3,281 feet) or below   |
| Wiring distance                 | 328 ft (100 m) or less between inverter and motor   |
| Vibration                       | 9.8 m/s <sup>2</sup> (1G) less than 20 Hz, up to 1.96 m/s <sup>2</sup> (0.2G) at 20 to 50 Hz  |
| <b>Other functions</b>          |   |
| Multi-function inputs           | Four of the following input signals are selectable: Reverse run (3-wire sequence), fault reset, external fault (NO/NC contact input), multi-step speed operation, Jog command, accel/decel time select, external baseblock (NO/NC contact input), speed search command, accel/decel hold command, LOCAL/REMOTE selection, communication/control circuit terminal selection, emergency stop fault, emergency stop alarm. |
| Multi-function outputs          | Following output signals are selectable (1 NO/NC contact output): Fault, running, zero speed, at frequency, frequency detection (output frequency = or = set value), during overtorque detection, minor error, during baseblock, operation mode, inverter run ready, during fault retry, during under-voltage, during speed search, data output through communication.  |
| Standard functions              | Full-range automatic torque boost, slip compensation, DC injection braking current/time at start/stop frequency reference bias/gain, frequency reference with built-in potentiometer, MEMOBUS communications (RS-485/422, max. 19.2 K bps) capable with optional unit.  |

## 3G3JV Inverter Ordering Information

| Description                        | Enclosure    | Rating |               |       | Model         |
|------------------------------------|--------------|--------|---------------|-------|---------------|
|                                    |              | HP     | Voltage       | Phase |               |
| Compact inverter with V/Hz control | NEMA 1       | 1/8    | 240           | 1     | 3G3JV-AB001-A |
|                                    |              | 1/4    | 240           | 1     | 3G3JV-AB002-A |
|                                    |              | 3/4    | 240           | 1     | 3G3JV-AB004-A |
|                                    |              | 1      | 240           | 1     | 3G3JV-AB007-A |
|                                    |              | 2      | 240           | 1     | 3G3JV-AB015-A |
|                                    |              | 1/8    | 230           | 3     | 3G3JV-A2001-A |
|                                    |              | 1/4    | 230           | 3     | 3G3JV-A2002-A |
|                                    |              | 3/4    | 230           | 3     | 3G3JV-A2004-A |
|                                    |              | 1      | 230           | 3     | 3G3JV-A2007-A |
|                                    |              | 2      | 230           | 3     | 3G3JV-A2015-A |
|                                    | Open chassis | 3      | 230           | 3     | 3G3JV-A2022-A |
|                                    |              | 5      | 230           | 3     | 3G3JV-A2037-A |
|                                    |              | 1/2    | 460           | 3     | 3G3JV-A4002-A |
|                                    |              | 1      | 460           | 3     | 3G3JV-A4004-A |
|                                    |              | 2      | 460           | 3     | 3G3JV-A4007-A |
|                                    |              | 3      | 460           | 3     | 3G3JV-A4015-A |
|                                    |              | 3      | 460           | 3     | 3G3JV-A4022-A |
| 5                                  | 460          | 3      | 3G3JV-A4037-A |       |               |

## Manuals

| Item          | Description         | Model     |
|---------------|---------------------|-----------|
| User's manual | 3G3JV User's manual | I528-E3-1 |

# Inverters

# 3G3MV

Quick Link  
A032

## Versatile Compact Inverter Offers Loop Vector and V/Hz Control

- Intuitive digital operator controls all parameter selections and settings
- Quick Start LEDs for fast setup and troubleshooting
- Standard PID control
- Modbus serial communications standard
- DeviceNet communications unit (optional) allows remote monitoring of Run/Stop status and operating conditions, and making changes to set values
- Fine-tune speed using the potentiometer on the digital operator
- User-selectable open loop vector and V/Hz control methods
- NEMA 4X models meet requirements for tough washdown and dust-tight environments
- NEMA 1 models available
- Compact size: Single phase, 230 VAC: 148 H x 170 W x 180 D mm max.
  - Three-phase, 230 VAC: 260 H x 180 W x 170 D mm max.
  - Three-phase, 460 VAC: 260 H x 180 W x 170 D mm max.
- Integrate a full-featured PLC into 3G3MV inverters with 6 input/4 output points, encoder input, interrupt inputs and pulse outputs; dual port RAM for 200 transfers per second; eliminates point-to-point wiring



## Specifications

### General Specifications

| Power supply                            |  |                                 |
|---|--|---------------------------------|
| Rated input voltage & frequency         | 3-phase, 200 to 230 V, 50/60 Hz<br>Single-phase, 200 to 240 V, 50/60 Hz  | 3-phase, 380 to 460 V, 50/60 Hz |
| Allowable voltage fluctuation           | -15% to +10%   |                                 |
| Allowable frequency fluctuation         | ±5%  |                                 |
| Control characteristics                 |  |                                 |
| Control method                          | Sine wave PWM (V/f control or voltage vector control, selectable); possible to program any V/f pattern   |                                 |
| Frequency control range                 | 0.1 to 400 Hz  |                                 |
| Frequency accuracy (temperature change) | Digital reference: ±0.01%, 14 to 122°F (-10 to +50°C)<br>Analog reference: ±0.5%, 59 to 95°F (25±10°C)   |                                 |
| Frequency setting resolution            | Digital reference: 0.1 Hz (less than 100 Hz)/0.1 Hz (100 Hz or more)<br>Analog reference: (0:06/60 Hz) equivalent to 1/1000 of max. output frequency   |                                 |
| Output frequency resolution             | 0.01 Hz  |                                 |
| Overload capacity                       | 150% rated output current for one minute   |                                 |
| Frequency setting signal                | 0 to 10 VDC (20 kΩ), 4 to 20 mA (250 Ω), 0 to 20 mA (250 Ω) pulse train input, frequency setting potentiometer (Selectable)  |                                 |
| Accel/Decel                             | 0.01 to 6000 seconds (accel/decel time are independently programmed 2 types)   |                                 |
| Braking torque                          | Short-term average deceleration torque:<br>0.1, 0.25 kW (0.13 HP, 0.25 HP): 150%; 0.55, 1.1 kW): (0.5 HP, 1 HP): 100% 1.5 kW (2 HP): 50%; 2.2 kW (3 HP) or more: 20%<br>Continuous regenerative torque: Approx. 20% (150% with optional braking resistor, braking transistor built-in) |                                 |



## General Specifications (Continued)

| Protective functions      |   |
|---------------------------|---|
| Motor overload protection | UL-recognized electronic thermal overload relay   |
| Instantaneous overcurrent | Motor coasts to a stop at approximately 250% inverter rated current   |
| Overload                  | Motor coasts to a stop after one minute at 150% rated output current  |
| Overvoltage               | Motor coasts to a stop if DC bus voltage exceeds 410 V   Motor coasts to a stop if DC bus voltage exceeds 820 V   |
| Undervoltage              | Stops when DC bus voltage is approximately 200 V or less (approx. 160 V or less for single-phase series)   Stops when DC bus voltage is approximately 400 V or less   |
| Momentary power loss      | Stops if power loss is 15 ms or more. By setting inverter, operation can be continued if power is restored within approximately 0.5 s   |
| Cooling method            | Cooling fan is provided for the following models:<br>200 V, 0.75 kW or larger inverters (3-phase)<br>200 V, 1.5 kW or larger inverters (single-phase)<br>Others models are self-cooling   |
| Cooling fin overheat      | Protected by electronic circuit   |
| Cooling fan fault         | Protected by electronic circuit (fan lock detection)  |
| Stall prevention          | Individual levels during acceleration/running, enable/disable provided during coast to a stop   |
| Ground fault              | Protected by electronic circuit (overcurrent level)   |
| Power charge indication   | ON until the DC bus voltage becomes 50 V or less. RUN lamp stays ON or digital operator LED stays ON.   |
| Environmental conditions  |   |
| Enclosure rating          | Enclosed wall mounted NEMA 1  |
| Location                  | Indoor (free from corrosive gases and dust)   |
| Ambient temperature       | Enclosed wall mounted NEMA 1: 14 to 105° F (-10 to +40°C), not frozen   |
| Storage temperature       | -4 to 140°F (-20 to 60°C)   |
| Humidity                  | 95% RH or less (Non-condensing)   |
| Elevation                 | 1,000 m (3,281 feet) or below   |
| Wiring distance           | 328 ft (100 m) or less between inverter and motor   |
| Vibration                 | 9.8 m/s <sup>2</sup> (1G) less than 20 Hz, up to 2 m/s <sup>2</sup> (0.2G) at 20 to 50 Hz   |
| Other functions           |   |
| Multi-function inputs     | Seven of the following input signals are selectable: Forward/reverse run (3-wire sequence), fault reset, external fault (NO/NC contact input), multi-step speed operation, Jog command, accel/decel time select, external base block (NO/NC contact input), speed search command, UP/DOWN command, accel/decel hold command, LOCAL/REMOTE selection, communication/control circuit terminal selection, emergency stop fault, emergency stop alarm, self test, PID control cancel, PID integral reset/hold |
| Multi-function outputs    | Following output signals are selectable (1 NO/NC contact output, 2 photo-coupler outputs): Fault, running, zero speed, at frequency, frequency detection (output frequency = or = set value), during overtorque detection, during undervoltage detection, minor error, during baseblock, operation mode, inverter run ready, during fault retry, during UV, during speed search, data output through communication, PID feedback loss detection   |
| Standard functions        | Voltage vector control, full-range automatic torque boost, slip compensation, DC injection braking current/time at start/stop frequency reference bias/gain, MEMOBUS communications (RS-485/422, max. 19.2 K bps), PID control, energy-saving control, parameter copy, frequency reference with built-in potentiometer  |

## Inverter PLC Specifications

| Model             | 3G3MV-P10CDT3-E   | 3G3MV-P10CDT-E  |
|-------------------|---|---|
| Type              | Full feature PLC installs on face of 3G3MV inverters with 1/4 to 10 HP rating   |   |
| I/O points        | 6 input points (bi-directional input at 5 kHz; unidirectional input at 20 kHz)<br>4 output points (1 relay, 3 NPN transistor);<br>I/O can be set for interrupt inputs (50 μs response) or pulse outputs |   |
| Clock/calendar    | Yes   | No  |
| Encoder interface | Yes   | Yes   |
| Connectivity      | Direct HMI connection<br>Peripheral port<br>Serial ports: RS-232C, RS-422/485   | Direct HMI connection<br>Peripheral port<br>RS-232C serial port |
| Memory backup     | Flash memory and battery  | Flash memory and capacitor                                      |
| Dimensions        | 128 H x 68 W x 38.1 D mm  |   |
| Software          | CX-Programmer included in CX-One  |   |



## Ordering Information

### MV Inverter

| Description   | Enclosure                           | Rating |             |              | Model            |                   |
|---|-------------------------------------|--------|-------------|--------------|------------------|-------------------|
|   |                                     | HP     | Voltage     | Phase        | NEMA 1 enclosure | NEMA 4X enclosure |
| Compact inverter with open loop vector and V/Hz control methods | NEMA 1 and NEMA 4X models available | 1/8    | 230         | 1            | 3G3MV-CB001      | —                 |
|   |                                     | 1/4    | 230         | 1            | 3G3MV-CB002      | —                 |
|   |                                     | 3/4    | 230         | 1            | 3G3MV-CB004      | —                 |
|   |                                     | 1      | 230         | 1            | 3G3MV-CB007      | —                 |
|   |                                     | 2      | 230         | 1            | 3G3MV-CB015      | —                 |
|   |                                     | 3      | 230         | 1            | 3G3MV-CB022      | —                 |
|   |                                     | 5      | 230         | 1            | 3G3MV-CB037      | —                 |
|   |                                     | 1/8    | 230         | 3            | 3G3MV-C2001      | —                 |
|   |                                     | 1/4    | 230         | 3            | 3G3MV-C2002      | V7CU-20P2-N4      |
|   |                                     | 3/4    | 230         | 3            | 3G3MV-C2004      | V7CU-20P4-N4      |
|   |                                     | 1      | 230         | 3            | 3G3MV-C2007      | V7CU-20P7-N4      |
|   |                                     | 2      | 230         | 3            | 3G3MV-C2015      | V7CU-21P5-N4      |
|   |                                     | 3      | 230         | 3            | 3G3MV-C2022      | V7CU-22P2-N4      |
|   |                                     | 5      | 230         | 3            | 3G3MV-C2037      | V7CU-23P7-N4      |
|   |                                     | 7 1/2  | 230         | 3            | 3G3MV-C2055      | V7CU-25P5-N4      |
|   |                                     | 10     | 230         | 3            | 3G3MV-C2075      | V7CU-27P5-N4      |
|   |                                     | 1/2    | 460         | 3            | 3G3MV-C4002      | V7CU-40P2-N4      |
|   |                                     | 1      | 460         | 3            | 3G3MV-C4004      | V7CU-40P4-N4      |
|   |                                     | 2      | 460         | 3            | 3G3MV-C4007      | V7CU-40P7-N4      |
|   |                                     | 3      | 460         | 3            | 3G3MV-C4015      | V7CU-41P5-N4      |
| 3 1/2   | 460                                 | 3      | 3G3MV-C4022 | V7CU-42P2-N4 |                  |                   |
| 5   | 460                                 | 3      | 3G3MV-C4037 | V7CU-43P7-N4 |                  |                   |
| 10  | 460                                 | 3      | 3G3MV-C4055 | V7CU-45P5-N4 |                  |                   |
| 12 1/2  | 460                                 | 3      | 3G3MV-C4075 | V7CU-47P5-N4 |                  |                   |

### Accessories

| Item                      | Description   | Model                                   |                  |
|---------------------------|---|---|------------------|
| Inverter PLC              | Advanced PLC with 6 inputs/4 outputs; built-in real-time clock/calendar and encoder interface; RS-422/485 and RS-232C serial communications   | 3G3MV-P10CDT3-E                         |                  |
|                           | Standard PLC with 6 inputs/4 outputs, encoder interface and RS-232C serial communications   | 3G3MV-P10CDT-E                          |                  |
| DeviceNet unit            | DeviceNet slave unit; permits a PLC to monitor Run/Stop and operating conditions and make changes in set values. Remote I/O and message communications can be used simultaneously between the PLC and 3G3MV inverter. | 3G3MV-PDRT2                             |                  |
| DIN rail mounting bracket | Single-phase, 230 VAC   | 3G3MV-□B001/-□B002/-□B004               | 3G3IV-PEZZ08122A |
|                           |   | 3G3MV-□B007/-□B015                      | 3G3IV-PEZZ08122B |
|                           |   | 3G3MV-□B022                             | 3G3IV-PEZZ08122C |
|                           |   | 3G3MV-□B037                             | 3G3IV-PEZZ08122D |
|                           | 3-phase, 230 VAC  | 3G3MV-□2001/-□2002/-□2004/-□2007        | 3G3IV-PEZZ08122A |
|                           |   | 3G3MV-□2015/-□2022                      | 3G3IV-PEZZ08122B |
|                           |   | 3G3MV-□2037                             | 3G3IV-PEZZ08122C |
|                           | 3-phase, 460 VAC  | 3G3MV-□4002/-□4004/-□4007/-□4015/-□4022 | 3G3IV-PEZZ08122B |
|                           |   | 3G3MV-□4037                             | 3G3IV-PEZZ08122C |

### Support Software and Programming Devices

| Item          | Description  | Model              |
|---------------|--|--------------------|
| CX-Drive      | Windows®-based programming software for setup; uploads and downloads parameters and monitoring | Included in CX-ONE |
| CX-Programmer | Sets up and monitors PLC operations  | Included in CX-ONE |

### Manuals

| Item           | Description  | Model     |
|----------------|--|-----------|
| User's manual  | 3G3MV Series Multi-function Compact Inverter User Manual   | I527-E3-2 |
| DeviceNet unit | 3G3MV-PDRT2 DeviceNet Communications Unit Operation Manual | I539-E1-2 |

# Inverters G5+

Quick Link  
G089

## Flux Vector Inverter 600V Constant Torque for Machine Automation

The G5+ Inverter offers ultra-fast processing. All systems are controlled by a 32-bit, 20 MHz RISC processor, which executes basic instructions in one clock cycle. The processor uses an innovative "5 stage pipeline architecture" which allows the processor to perform 5 instructions at one time. This results in a rating of 16 MIPS (Million Instructions Per Second).

- The control board is common to all chassis inverter sizes
- Field upgradeable Flash ROM
- Four programmable control modes to suit any specific application.
- Built-in motor auto-tuning for easy start-up
- 2 sets of motor constants — very useful in machine tools applications
- 2 Line x 16 characters alphanumeric operator makes programming easier to understand
- Dedicated Serial Communication Port allows to network the G5+ with other devices
- PID function with feedback loop
- Energy savings software helps reduce power consumption
- Customized CASE software for specific applications



Canada Only



## Specifications

| Power supply                    |   |
|---------------------------------|---|
| Rated input voltage & frequency | 3-phase, 500/575/600 VAC, 50/60Hz   |
| Allowable voltage fluctuation   | -15% of 500 VAC; +10% of 600 VAC  |
| Allowable frequency fluctuation | ±5%   |
| Control characteristics         |   |
| Control method                  | Sine coded PWM (digital flux vector)  |
| Starting torque                 | 150% below 1 Hz (150% at 0 RPM with PG)   |
| Speed control range             | 100:1 (1000:1 with PG)  |
| Speed control accuracy          | ±0.2% (±0.02% with PG)  |
| Speed response                  | 5 Hz (30 Hz with PG)  |
| Torque limit                    | Can be set by parameter: 4 steps available  |
| Torque accuracy                 | ±5%   |
| Torque response                 | 20 Hz (40 Hz with PG)   |
| Frequency control range         | 0.1 to 400 Hz   |
| Frequency accuracy              | Digital Command: ±0.01%, +14° to 104°F (-10° to 40°C)<br>Analog Command: ±0.1%, 77±18°F (25±10°C)   |
| Frequency setting resolution    | Digital Operator Reference: 0.01 Hz (12 bits)<br>Analog Reference: 0.03 Hz/60 Hz (14 bits)  |
| Output frequency resolution     | 0.01 Hz   |
| Overload capacity               | 150% rated output current for one minute  |
| Frequency setting signal        | -10 to +10 V, 0 to +10 V, 4 to 20 mA  |
| Accel/Decel                     | 0.01 to 6000.0 seconds (Accel/Decel time setting independently; 4 steps available)  |
| Braking torque                  | Approximately 20% (Approximately 125% when using braking resistor*) *Set I3-04=0 (Stall Prevention selection during decel is disabled) when connecting braking transistors or braking resistor. |
| Protective functions            |   |
| Motor overload protection       | UL-recognized electronic thermal overload relay   |

## Specifications (Continued)

|                                 |  |
|---------------------------------|--|
| Instantaneous overcurrent       | Motor coasts to a stop at approximately 200% rated output current  |
| Fuse protection                 | Motor coasts to a stop at blown fuse   |
| Overload                        | Motor coasts to a stop after one minute at 150% rated output current   |
| Overvoltage                     | Motor coasts to a stop if converter output voltage exceeds 1,050 VDC at 600 V input  |
| Undervoltage                    | Motor coasts to a stop if converter output voltage drops to 546 VDC or below at 600 V input  |
| Momentary power loss            | Immediate stop after 15ms or longer power loss (setting mode before shipment)  |
| Fin overheat                    | Thermostat   |
| Stall prevention                | Stall prevention during accel/decel and constant speed operation   |
| Ground fault                    | Provided by electronic circuit (overcurrent level)   |
| Power charge indication         | Charge led stays ON until bus voltage drops below 50 VDC   |
| <b>Environmental conditions</b> |  |
| Location                        | Indoor (Protected from corrosive gases and dust)   |
| Ambient temperature             | +14 to 104°F (-10 to 40°C) for NEMA 1 type<br>+14 to 113°F (-10 to 45°C) for Open Chassis Type   |
| Storage temperature             | -4 to 140°F (-20 to 60°C)  |
| Humidity                        | 95% RH (Non-condensing)  |
| Elevation                       | 1,000 m (3,281 feet) or below  |
| Wiring distance                 | 328 ft (100 m) or less between inverter and motor  |
| Vibration                       | 9.8 m/s <sup>2</sup> (1G) less than 20 Hz, up to 1.96 m/s <sup>2</sup> (0.2G) at 20 to 50 Hz   |
| <b>Other functions</b>          |  |
| Input signals                   | 3 Analog Inputs available (0 to 10 V, -10 to +10 V, 4 to 20 mA)  |
| Multi-function inputs           | 8 Digital Inputs with 6 programmable for functions such as: 3 wire sequencing (2 wire is standard), multi-step speed operation, fault reset, external fault (NO or NC), jog, accel/decel time select, MOP function, speed search command, Local/Remote selection, motor 1 or 2 selection, PID disable, PID reset, trim increase or decrease, fast stop, analog signal selection, and many others |
| Output signals                  | 2 Analog Outputs (0 to 10 V) with 25 different settable functions  |
| Multi-function outputs          | 4 Digital Outputs (Form C fault contacts plus 3 programmable outputs [1 form A, 2 open collector]). Programmable Output functions available are: run signal, zero speed, frequency agree (2), frequency detection (4), torque level detection (2), timer output, at current/torque limit, regenerating, minor or major fault, DB overheat, loss of reference, and many others.                   |
| Standard functions              | Settable for V/Hz, open loop vector, or closed loop vector, DC injection braking, PID control, zero servo mode, energy saving mode, 4 accel/decel times with S-curve, 8 preset speeds, slip and torque compensation, 3 jump frequencies, stall prevention, auto restart, and many other standard features.   |

## Ordering Information

### G5+ Inverter

| Description                                       | Enclosure    | Rating                 | Model       |
|---|--------------|------------------------|-------------|
| Flux vector inverter with constant torque control | NEMA 1       | 2 HP, 3.5 A, 575 VAC   | G5M-51P5-N1 |
|   |              | 3 HP, 4.1 A, 575 VAC   | G5M-52P2-N1 |
|   |              | 5 HP, 6.3 A, 575 VAC   | G5M-53P7-N1 |
|   |              | 7.5 HP, 9.8A, 575 VAC  | G5M-55P5-N1 |
|   |              | 10 HP, 12.5 A, 575 VAC | G5M-57P5-N1 |
|   |              | 15 HP, 17.0 A, 575 VAC | G5M-5011-N1 |
|   |              | 20 HP, 22.0 A, 575 VAC | G5M-5015-N1 |
|   |              | 25 HP, 27.0 A, 575 VAC | G5M-5018-N1 |
|   |              | 30 HP, 32.0 A, 575 VAC | G5M-5022-N1 |
|   |              | 40 HP, 41.0 A, 575 VAC | G5M-5030-N1 |
|   |              | 50 HP, 52.0 A, 575 VAC | G5M-5037-N1 |
|   |              | 60 HP, 62.0 A, 575 VAC | G5M-5045-N1 |
|   |              | 75 HP, 77 A, 575 VAC   | G5M-5055-N1 |
|   |              | 100 HP, 99 A, 575 VAC  | G5M-5075-N1 |
|   | Open chassis | 120 HP, 130 A, 575 VAC | G5M-5090-N0 |
|   |              | 150 HP, 172 A, 575 VAC | G5M-5110-N0 |
|   |              | 200 HP, 200 A, 575 VAC | G5M-5160-N0 |

## Support Software and Programming Devices

| Item     | Description   | Model              |
|----------|---|--------------------|
| CX-Drive | Windows®-based programming software for sets up Uploads and downloads parameters and monitoring | Included in CX-ONE |

## Manuals

| Item          | Description       | Model |
|---------------|-------------------|-------|
| User's manual | G5+ User's manual | IM-G5 |

# Inverters P5+



## Powerful 600V Variable Torque Inverter for Building Automation

- Energy savings software helps reduce power consumption
- Built-in PID function allows feedback loop
- Highly programmable with 116 parameters
- UL listed electronic thermal overload that eliminates external devices
- Speed search function restarts a coasting motor without stopping it, after a power loss
- Multi-function Inputs (5) & Outputs (3) for increased flexibility
- 5 preset speeds (4 speeds + jog) allows multi-step operation
- Stall prevention/Current limit prevent overcurrent trips and motor stall
- Momentary power loss ride-through Continue the operation, after recovery from a momentary power loss
- Critical frequency lockouts (2) to avoid mechanical resonance (as in cooling towers)
- Alphanumeric digital operator makes programming easier to understand
- Communications cards for MetaSys N2, Apogee, and Echelon LONworks building automation protocols. Use optional communication card Modbus RTU to control up to 31 Drives
- Common control board across all models
- 3rd generation IGBT output section
- Terminals for optional DC link reactor (from 2HP / 600V up to 20 HP / 600V)
- Built-in braking IGBT (from 2HP / 600V up to 30 HP / 600V)
- Built-in RS-232C port for direct connection to programming tools



Canada Only



## Specifications

| Power Supply                         |   |
|--------------------------------------|---|
| 600V rated input voltage & frequency | 3-phase, 500/575/600 VAC, 50/60 Hz  |
| Allowable voltage fluctuation        | -15% of 500 VAC, +10% of 600 VAC  |
| Allowable frequency fluctuation      | ±5%   |
| Control Characteristics              |   |
| Control method                       | Sine Wave PWM   |
| Frequency control range              | 0.1 to 400 Hz   |
| Frequency accuracy                   | Digital Operator Reference: 0.01%<br>Analog Reference: 0.1%                 |
| Frequency setting resolution         | Digital Operator Reference: 0.01 Hz<br>Analog Reference: 0.06 Hz/60 Hz      |
| Output frequency resolution          | 0.01 Hz   |
| Overload capacity                    | 120% rated output current for one minute (150% for constant torque rating)  |
| Frequency setting signal             | 0 to +10 V (20 kΩ), 4 to 20 mA (250 Ω)                                      |
| Accel/Decel                          | 0.01 to 3600.0 sec (Accel/Decel time setting independently; 0.1sec)         |
| Braking torque                       | Approximately 20%   |
| Protective Functions                 |   |
| Motor overload protection            | UL recognized internal electronic thermal overload relay (I <sup>2</sup> t) |

## Specifications (Continued)

|                                 |  |
|---------------------------------|--|
| Instantaneous overcurrent       | Motor coasts to a stop at approximately 180% rated output current  |
| Fuse protection                 | Motor coasts to a stop at blown fuse   |
| Overload                        | Motor coasts to a stop after one minute at 120% rated output current (150% for constant torque)  |
| Overvoltage                     | Motor coasts to a stop if converter output exceeds 1,050 VDC at 600 VAC input  |
| Undervoltage                    | Motor coasts to a stop if converter output voltage drops below 546 VDC   |
| Momentary power loss            | Immediate stop after 15 ms or longer power loss<br>(Continuous system operation during power loss less than 2 seconds is equipped as standard)   |
| Fin overheat                    | Thermistor – OH1, OH2  |
| Stall prevention                | Stall prevention during accel/decel and constant speed operation   |
| Ground fault                    | Provided by electronic circuit   |
| Power charge indication         | Charge LED stays on until bus voltage drops below 50 VDC   |
| <b>Environmental Conditions</b> |  |
| Location                        | Indoor (Protected from corrosive gases and dust)   |
| Ambient temperature             | +14 to 104°F (-10 to 40°C) for NEMA 1 type (not frozen)<br>+14 to 113° F (-10 to 45° C) for Open Chassis type  |
| Storage temperature             | -4 to 140°F (-20 to 60°C)  |
| Humidity                        | 95% RH (non-condensing)  |
| Elevation                       | 1000 m (3281 feet) or below  |
| Vibration                       | 9.8 m/s <sup>2</sup> (1G) less than 20 Hz, up to 1.96 m/s <sup>2</sup> (0.2G) at 20 to 50 Hz   |
| Wiring distance                 | 328 ft (100 m) or less between inverter and motor  |
| <b>Other Functions</b>          |  |
| Analog inputs                   | 2 analog inputs available (0-10 V, 4-20 mA)  |
| Multi-function digital inputs   | 6 Digital Inputs with 5 programmable for functions such as: 3 wire sequencing (2 wire is standard), multi-step speed operation, fault reset, external fault (NO or NC), jog, accel/decel time select, speed search command, Local/Remote selection, PID disable, PID reset, fast stop, serial communication select, timer start, parameter lockout, and many others. |
| Analog outputs                  | 1 Analog Output (0-10 V) settable as output frequency, output current, output KW, or DC bus voltage.   |
| Multi-function digital outputs  | 2 Programmable Digital Outputs (1 form C and 1 form A), Programmable functions available are: run signal, fault, at speed, frequency detection (2), overtorque detection (NO or NC), timer output, loss of reference or PID feedback, and many others.   |
| Standard functions              | DC injection braking, PID control, Energy Saving mode, 2 accel/decel times with S-curve, 4 preset speeds, selectable for constant or variable torque, 2 jump frequencies, stall prevention, auto restart, power-loss ride through, and many other standard features.   |

## Ordering Information

### P5+ Inverter

| Description              | Enclosure | Rating                    | Model                      |
|--------------------------|-----------|---------------------------|----------------------------|
| Variable torque inverter | NEMA 1    | 2 to 3 HP, 3.9 A, 600 VAC | P5M-51P5-N1                |
|                          |           | 5.0 HP, 7.0 A, 600 VAC    | P5M-53P7-N1                |
|                          |           | 7.5/10 HP, 11 A, 600 VAC  | P5M-55P5-N1                |
|                          |           | 15 HP, 19 A, 600 VAC      | P5M-5011-N1                |
|                          |           | 20 HP, 25 A, 600 VAC      | P5M-5015-N1                |
|                          |           | 25 HP, 30 A, 600 VAC      | P5M-5018-N1                |
|                          |           | 30 HP, 36 A, 600 VAC      | P5M-5022-N1                |
|                          |           | 40 HP, 46 A, 600 VAC      | P5M-5030-N1                |
|                          |           | 50 HP, 58 A, 600 VAC      | P5M-5037-N1                |
|                          |           | 60 HP, 69 A, 600 VAC      | P5M-5045-N1                |
|                          |           | 75 HP, 86 A, 600 VAC      | P5M-5055-N1                |
|                          |           | 100 HP, 111 A, 600 VAC    | P5M-5075-N1                |
|                          |           | Open chassis              | 125/150 HP, 145 A, 600 VAC |
|                          |           | 200 HP, 192 A, 600 VAC    | P5M-5110-N0                |

## Manuals

| Item          | Description   | Model |
|---------------|---------------|-------|
| User's manual | User's manual | IM-P5 |

# Inverters

# RV

Quick Link

A036

## Flux Vector Inverter for General-Purpose & High-End Applications

- Wide range of sizes available in 230 VAC and 460 VAC, from ½ to 150 HP in 230 VAC and ¼ to 500 HP in 460 VAC. It is UL, cUL and CE compliant
- Volts/Hertz setting for simple applications and open or closed loop vector control for advanced applications satisfy most motor control needs
- Built-in functions like PID parameter calculation, Energy savings, Configurable digital and analog I/O, Over-current tripping protection ensures uninterrupted operation, DC Bus choke above 30 HP, and 12 pulse rectification standard above 50 HP (100 HP at 460 V)
- New static auto-tune function that eliminates the need for motor rotation to determine and set parameters
- High-slip braking function for intermittent braking applications shortens motor stopping time by one-third without using braking resistors
- Broad Network Communications available like a built-in RS-485/422 Modbus communications protocol and made available optional cards for DeviceNet (3G3RV-PDRT2), Modbus Plus (CM071), Ethernet Modbus TCP/IP (CM090), LONWorks (CM048) and Profibus-DP (CM061)



### Canada Only

- High reliability with an MTBF of 28 years
- Easy to maintain and inspect the cooling fan with detachable fan design and life-prolonging automatic fan shutoff; split cover panel allows safe access to control terminals
- Quick inverter setup simplified through a quick program mode and the standard keypad doubles as a copy unit to set multiple drives
- Removable terminal strip eliminates the need to re-wire the drive
- Integrate a PLC into 3G3RV inverters with 6 input/4 output points, clock/calendar and encoder interface built in
- All RV models have a unique, low-carrier PWM control to suppress audible noise

## Specifications

### Inverters

| Control characteristics                          |   |
|--|---|
| Control method                                   | Sine wave PWM; Closed loop flux vector, Open loop vector control, V/f control, V/f with PG control (switched by parameter setting)  |
| Speed control range                              | 100:1 (1000:1 with PG)  |
| Speed control accuracy                           | ±0.2% (25°C ±10°C) (±0.02% with PG)   |
| Speed control response                           | 5 Hz (30 Hz with PG)  |
| Torque characteristics                           | Heavy duty/CT selected (low carrier, fixed torque applications): 150% /0.5 Hz (Open or closed loop vector control)<br>Normal duty/VT selected (high carrier, variable torque applications): 120%/0.5 Hz   |
| Frequency control range                          | 0.01 to 300 Hz (CT selected.), 0.01 to 400 Hz (VT selected.)  |
| Frequency accuracy (temperature characteristics) | Digital references: ±0.01% (-10°C to +40°C)<br>Analog references: ±0.1% (25°C ±10°C)  |
| Frequency setting resolution                     | Digital references: 0.01 Hz<br>Analog references: 0.03 Hz/60 Hz (10 bit with sign)  |
| Output frequency resolution                      | 0.001 Hz  |
| Overload capacity and maximum current            | Heavy duty/CT selected: 150% of rated output current per minute<br>Normal duty/VT selected: Approximately 110% of rated output current per minute   |
| Frequency setting signal                         | Voltage input of 0 to ±10 or 0 to 10 (20 kΩ) VDC or current input of 4 to 20 mA   |
| Acceleration/deceleration time                   | 0.01 to 6000.0 s (4 selectable combinations of independent acceleration and deceleration settings)  |
| Braking torque                                   | Approximately 20% (Approximately 125% with Braking Resistor option) (100% + with High Slip Braking)   |
| Main control functions                           | Auto restart after momentary power loss, speed searches, overtorque detection, torque limits, 16-speed control (maximum), acceleration/deceleration time changes, S-curve acceleration/deceleration, 2-wire or 3-wire sequence, auto-tuning (rotational or stationary), dwell functions, cooling fan ON/OFF control, slip compensation, torque compensation, jump frequencies, upper and lower frequency limits, DC injection braking for starting and stopping, high-slip braking, PID control (with sleep function), energy saving control, RS-485/422A communications (Conforms to Modbus, 19.2 kbps maximum), fault reset, and function copying |



| Protective functions              |  |
|-----------------------------------|--|
| Motor protection                  | UL recognized protection by electronic thermal overload relay ( <sup>2</sup> t).   |
| Overcurrent protection            | Instantaneous protection. Stops at approximately 200% of rated output current.   |
| Overload protection               | Heavy duty/CT selected (low carrier, fixed torque applications): 150% of rated output current per minute (not for 110 kW)<br>Normal duty/VT selected (high carrier, variable torque applications): Approximately 110% of rated output current per minute |
| Overvoltage protection            | 200 Class Inverter: Stops when main-circuit DC voltage is above 410 VDC.<br>400 Class Inverter: Stops when main-circuit DC voltage is above 820 VDC.   |
| Undervoltage protection           | 200 Class Inverter: Stops when main-circuit DC voltage is below 190 VDC.<br>400 Class Inverter: Stops when main-circuit DC voltage is below 380 VDC.   |
| Momentary power loss ride-through | Stops for 15 ms or more. By selecting the momentary power loss method, operation can be continued if power is restored within 2 s.   |
| Cooling fin overheating           | Protection by thermistor   |
| Grounding protection              | Protection by electronic circuits. (Overcurrent level)   |
| Charge indicator                  | Lit when the main circuit DC voltage is approximately 50 V or more.  |
| Environmental conditions          |  |
| Application site                  | Indoor (no corrosive gas, dust, etc.)  |
| Ambient operating temperature     | -10°C to 40°C (Closed wall-mounted type) / 10°C to 45°C (Open chassis type)  |
| Storage temperature               | -20°C to + 60°C (short-term temperature during transportation)   |
| Ambient operating humidity        | 95% max. (with no condensation)  |
| Altitude                          | 3300 ft (1000 m) max.  |
| Vibration                         | 10 to 20 Hz, 9.8 m/s <sup>2</sup> max.; 20 to 50 Hz, 2 m/s <sup>2</sup> max, oscillation vibration of 20 Hz  |
| Protective enclosure              | Enclosed, wall-mounting (NEMA1: Equivalent to IP20) or Mounted in a panel (equivalent to IP00)   |

## Inverter PLC

|                   |   |
|-------------------|---|
| <b>Model</b>      | <b>3G3RV-P10ST8-E</b>   |
| Type              | Embedded board PLC, installs inside 3G3RV inverters   |
| I/O points        | 6 input points, 4 output points on the PLC board<br>256 I/O by using CompoBus/S distributed network |
| Clock/calendar    | Yes   |
| Encoder interface | Yes   |
| Connectivity      | Peripheral port<br>Serial ports: RS-232C, RS-422/485<br>CompoBus/S master<br>DeviceNet slave        |
| Software          | CX-Programmer included in CX-One  |

## Ordering Information

### RV Inverter

| Description  | Enclosure             | Rating                | Model                |
|--|-----------------------|-----------------------|----------------------|
| Flux vector inverter with selectable constant torque and variable torque | NEMA 1                | 0.5 HP 3.2 A, 230 VAC | RV-A2004             |
|  |                       | 1.0 HP 4.1 A, 230 VAC | RV-A2007             |
|  |                       | 2 HP 7 A, 230 VAC     | RV-A2015             |
|  |                       | 3 HP 9.6 A, 230 VAC   | RV-A2022             |
|  |                       | 5 HP 15 A, 230 VAC    | RV-A2037             |
|  |                       | 7.5 HP 23 A, 230 VAC  | RV-A2055             |
|  |                       | 10 HP 31 A, 230 VAC   | RV-A2075             |
|  |                       | 15 HP 45 A, 230 VAC   | RV-A2110             |
|  |                       | 20 HP 58 A, 230 VAC   | RV-A2150             |
|  |                       | 25 HP 71 A, 230 VAC   | RV-A2185             |
|  |                       | 30 HP 85 A, 230 VAC   | RV-A2220             |
|  |                       | 40 HP 115 A, 230 VAC  | RV-A2300             |
|  |                       | Open chassis          | 50 HP 145 A, 230 VAC |
|  | 60 HP 180 A, 230 VAC  |                       | RV-B2450             |
|  | 75 HP 215 A, 230 VAC  |                       | RV-B2550             |
|  | 100 HP 283 A, 230 VAC |                       | RV-B2750             |
|  | 125 HP 346 A, 230 VAC |                       | RV-B2900             |
|  | 150 HP 415 A, 230 VAC |                       | RV-B211K             |



## RV Inverter (Continued)

| Description   | Enclosure            | Rating                 | Model    |
|---|----------------------|------------------------|----------|
| Flux vector inverter with selectable constant torque and variable torque (cont'd) | NEMA 1               | ¾ HP 1.8 A, 460 VAC    | RV-A4004 |
|   |                      | 1 HP 2.1 A, 460 VAC    | RV-A4007 |
|   |                      | 2 HP 3.7 A, 460 VAC    | RV-A4015 |
|   |                      | 3 HP 5.3 A, 460 VAC    | RV-A4022 |
|   |                      | 5 HP 7.6 A, 460 VAC    | RV-A4037 |
|   |                      | 7.5 HP 12.5 A, 460 VAC | RV-A4055 |
|   |                      | 10 HP 17 A, 460 VAC    | RV-A4075 |
|   |                      | 15 HP 24 A, 460 VAC    | RV-A4110 |
|   |                      | 20 HP 31 A, 460 VAC    | RV-A4150 |
|   |                      | 25 HP 39 A, 460 VAC    | RV-A4185 |
|   |                      | 30 HP 45 A, 460 VAC    | RV-A4220 |
|   |                      | 40 HP 60 A, 460 VAC    | RV-A4300 |
|   |                      | 50 HP 75 A, 460 VAC    | RV-A4370 |
|   |                      | 60 HP 91 A, 460 VAC    | RV-A4450 |
|   | 75 HP 112 A, 460 VAC | RV-A4550               |          |
|   | Open chassis         | 100 HP 150 A, 460 VAC  | RV-B4750 |
|   |                      | 150 HP 180 A, 460 VAC  | RV-B4900 |
|   |                      | 200 HP 260 A, 460 VAC  | RV-B413K |
|   |                      | 250 HP 304 A, 460 VAC  | RV-B416K |
|   |                      | 300 HP 370 A, 460 VAC  | RV-B418K |
| 400 HP 506 A, 460 VAC   |                      | RV-B422K               |          |
|   |                      | 500 HP 675 A, 460 VAC  | RV-B430K |

## Accessories

| Item           | Description  | Model          |
|----------------|--|----------------|
| Inverter PLC   | Embedded PLC board with 6 inputs/4 outputs; built-in clock/calendar and encoder interface; CompoBus/S master and DeviceNet slave network capabilities  | 3G3RV-P10ST8-E |
| DeviceNet unit | DeviceNet slave unit; permits a PLC to monitor Run/Stop and operating conditions and make changes in set values. Remote I/O and message communications can be used simultaneously between the PLC and 3G3RV inverter | 3G3RV-PDRT2    |

## Support Software and Programming Devices

| Item     | Description   | Model              |
|----------|---|--------------------|
| CX-Drive | Windows®-based programming software for sets up Uploads and downloads parameters and monitoring | Included in CX-ONE |

## Manuals

| Item           | Description  | Model      |
|----------------|--|------------|
| User's manual  | 3G3RV Series Multi-function Compact Inverter User Manual   | I540-E3-02 |
| DeviceNet unit | 3G3□V-PDRT2 DeviceNet Communications Unit Operation Manual | I539-E1-02 |

## Position Controllers

## CJ1/CS1-NC/-CT/-HC

## PLC-Based Accurate Positioning Control

From simple position measurement to multi-axis synchronized control, Omron offers a full range of PLC-based solutions:

- High-Speed Counter modules gather position information from SSI or incremental encoders. Actual positions are compared with internally stored target values.
- Position Control modules are used for point-to-point positioning with servo drives or stepper motors. Target data and acceleration/deceleration curves can be adjusted on-the-fly.
- Position control modules equipped with MECHATROLINK-II interface can control multiple drives through a single, high-speed data link. Message routing through multiple communication layers allows the attached drives to be configured from any point in the control network.

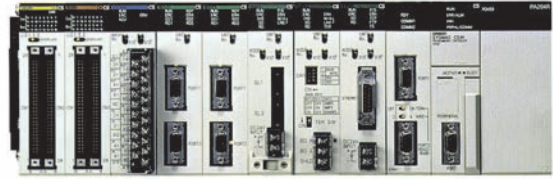

MECHATROLINK-II is a registered trademark of Yaskawa Corporation.

## Ordering Information

## CS1 Series

Modules are counted as Special I/O and occupy one rack slot.

| Channels /axes | Type                                | Signal type                 | Current consumption | Remarks  | Servo series                       | Connection type     | Model      |
|----------------|-------------------------------------|-----------------------------|---------------------|--|------------------------------------|---------------------|------------|
| 2              | SSI inputs (absolute position data) | Synchronous Serial Protocol | 320 mA              | Baud rate, encoding type, data length, etc. can be set per channel                                     | —                                  | M3 screw            | CS1W-CTS21 |
| 2              | 500 kHz counter                     | Line driver, 24 V           | 360 mA              | Configurable digital inputs + outputs; target values trigger interrupt to CPU                          | —                                  | 1 x 40 pt (Fujitsu) | CS1W-CT021 |
| 4              |                                     |                             | 450 mA              |  | —                                  | 2 x 40 (MIL-spec)   | CS1W-CT041 |
| 1              | Position controller                 | Open collector, 24 V        | 250 mA              | 500 kpps pulse outputs; inputs for origin, limit switches, stop, interrupt<br>Use CX-Position software | WT-Series<br>U-Series<br>SmartStep | 1 x 40 pt (Fujitsu) | CS1W-NC113 |
| 2              |                                     |                             | 250 mA              |  | WT-Series<br>U-Series<br>SmartStep | 1 x 40 pt (Fujitsu) | CS1W-NC213 |
| 4              |                                     |                             | 360 mA              |  | WT-Series<br>U-Series<br>SmartStep | 2 x 40 pt (Fujitsu) | CS1W-NC413 |
| 1              | Position controller                 | Line driver                 | 250 mA              |  | WT-Series<br>U-Series<br>SmartStep | 1 x 40 pt (Fujitsu) | CS1W-NC133 |
| 2              |                                     |                             | 250 mA              |  | WT-Series<br>U-Series<br>SmartStep | 1 x 40 pt (Fujitsu) | CS1W-NC233 |
| 4              |                                     |                             | 360 mA              |  | WT-Series<br>U-Series<br>SmartStep | 2 x 40 pt (Fujitsu) | CS1W-NC433 |
| 16             | Position controller                 | MECHATROLINK-II             | 360 mA              | Position, speed and torque control; access to all drive parameters<br>Use CX-Motion NCF                | WN-Series<br>ML2                   | Mechatro-Link-II    | CS1W-NCF71 |

## Servo Relay Unit Connection Compatibility with CS1 Position Control Modules

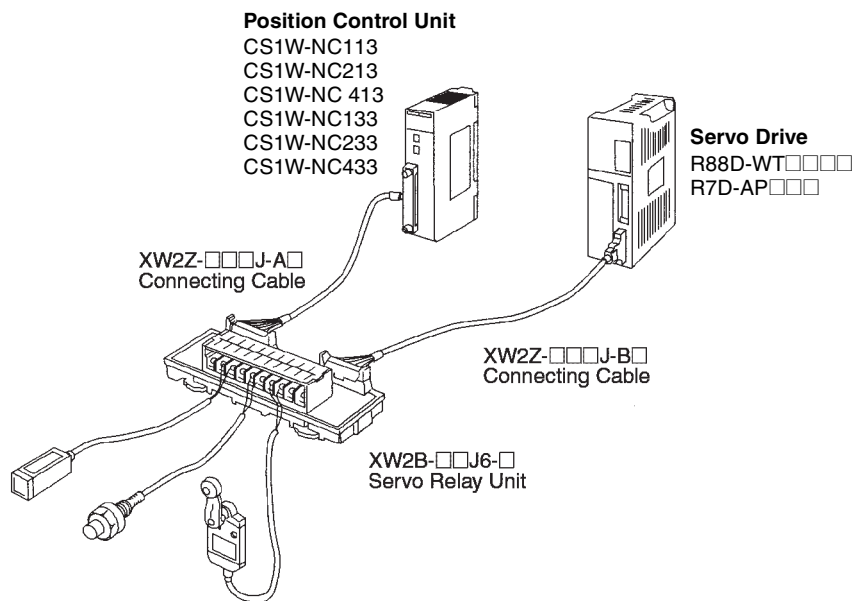

| Position control unit (PCU) | Cable between PCU and servo relay unit   | Servo relay unit | Cable between servo relay unit and servo driver | Servo driver                     |
|-----------------------------|--|------------------|---|----------------------------------|
| CS1W-NC113                  | XW2Z-050J-A6 (0.5 m)<br>XW2Z-100J-A6 (1 m)   | XW2B-20J6-1B     | XW2Z-100J-B4 (1 m)<br>XW2Z-200J-B4 (2 m)        | R88D-WT□□□□                      |
|                             | XW2Z-050J-A8 (0.5 m)<br>XW2Z-100J-A8 (1 m)   | XW2B-20J6-1B     | XW2Z-100J-B5 (1 m)<br>XW2Z-200J-B5 (2 m)        | R7D-AP□□□□                       |
| CS1W-NC213<br>CS1W-NC413    | XW2Z-050J-A7 (0.5 m)<br>XW2Z-100J-A7 (1 m)   | XW2B-40J6-2B     | XW2Z-100J-B4 (1 m)<br>XW2Z-200J-B4 (2 m)        | R88D-WT□□□□                      |
|                             |  | XW2B-40J6-4A     | XW2Z-100J-B8 (1 m)<br>XW2Z-200J-B8 (2 m)        | R88D-WT□□□□<br>when using RS-422 |
|                             | XW2Z-050J-A9 (0.5 m)<br>XW2Z-100J-A9 (1 m)   | XW2B-40J6-2B     | XW2Z-100J-B5 (1 m)<br>XW2Z-200J-B5 (2 m)        | R7D-AP□□□□                       |
|                             |  | XW2B-40J6-4A     | XW2Z-100J-B7 (1 m)<br>XW2Z-200J-B7 (2 m)        | R7D-AP□□□□<br>when using RS-422  |
| CS1W-NC133                  | XW2Z-050J-A10 (0.5 m)<br>XW2Z-100J-A10 (1 m)<br>XW2Z-050J-A12 (0.5 m)<br>XW2Z-100J-A12 (1 m) | XW2B-20J6-1B     | XW2Z-100J-B4 (1 m)<br>XW2Z-200J-B4 (2 m)        | R88D-WT□□□□                      |
|                             |  | XW2B-20J6-1B     | XW2Z-100J-B5 (1 m)<br>XW2Z-200J-B5 (2 m)        | R7D-AP□□□□                       |
| CS1W-NC233<br>CS1W-NC433    | XW2Z-050J-A11 (0.5 m)<br>XW2Z-100J-A11 (1 m)   | XW2B-40J6-2B     | XW2Z-100J-B4 (1 m)<br>XW2Z-200J-B4 (2 m)        | R88D-WT□□□□                      |
|                             |  | XW2B-40J6-4A     | XW2Z-100J-B8 (1 m)<br>XW2Z-200J-B8 (2 m)        | R88D-WT□□□□<br>when using RS-422 |
|                             | XW2Z-050J-A13 (0.5 m)<br>XW2Z-100J-A13 (1 m)   | XW2B-40J6-2B     | XW2Z-100J-B5 (1 m)<br>XW2Z-200J-B5 (2 m)        | R7D-AP□□□□                       |
|                             |  | XW2B-40J6-4A     | XW2Z-100J-B7 (1 m)<br>XW2Z-200J-B7 (2 m)        | R7D-AP□□□□<br>when using RS-422  |
| CS1W-HCP22-V1               | XW2Z-050J-A29 (0.5 m)<br>XW2Z-050J-A32 (0.5 m)<br>XW2Z-100J-A29 (1 m)<br>XW2Z-100J-A32 (1 m) | XW2B-80J7-1A     | XW2Z-100J-B11 (1 m)<br>XW2Z-200J-B11 (2 m)      | R88D-WT□□□□                      |
|                             |  |                  | XW2Z-100J-B12 (1 m)<br>XW2Z-200J-B12 (2 m)      | R7D-AP□□□□                       |

## CJ1 Series

Modules are counted as Special I/O, except 16-point CJ1W-NCF71, which is a CPU bus module.

| Channels/axes | Type                                | Signal type                          | Current consumption | Remarks  | Servo series                       | Connection type     | Model        |
|---------------|-------------------------------------|--------------------------------------|---------------------|--|------------------------------------|---------------------|--------------|
| 2             | SSI inputs (absolute position data) | Synchronous Serial Protocol          | 300 mA              | Baud rate, encoding type, data length, etc. can be set per channel                                     | —                                  | M3 screw            | CJ1W-CTS21-E |
| 2             | 500 kHz counter                     | Line driver, 24 V                    | 280 mA              | Configurable digital inputs + outputs;   | —                                  | 1 x 40 pt (Fujitsu) | CJ1W-CT021   |
| 4             | 100 kHz counter                     | Line driver, 24 V via terminal block | 320 mA              | Target values trigger interrupt to CPU   | —                                  | 1 x 40 (MIL-spec)   | CJ1W-CTL41-E |
| 1             | Position controller                 | Open collector, 24 V                 | 250 mA              | 500 kpps pulse outputs; inputs for origin, limit switches, stop, interrupt<br>Use CX-Position software | WT-Series<br>U-Series<br>SmartStep | 1 x 40 pt (Fujitsu) | CJ1W-NC113   |
| 2             |                                     |                                      | 250 mA              |  | WT-Series<br>U-Series<br>SmartStep | 1 x 40 pt (Fujitsu) | CJ1W-NC213   |
| 4             |                                     |                                      | 360 mA              |  | WT-Series<br>U-Series<br>SmartStep | 2 x 40 pt (Fujitsu) | CJ1W-NC413   |
| 1             | Position controller                 | Line driver                          | 250 mA              | 500 kpps pulse outputs; inputs for origin, limit switches, stop, interrupt<br>Use CX-Position software | WT-Series<br>U-Series<br>SmartStep | 1 x 40 pt (Fujitsu) | CJ1W-NC133   |
| 2             |                                     |                                      | 250 mA              |  | WT-Series<br>U-Series<br>SmartStep | 1 x 40 pt (Fujitsu) | CJ1W-NC233   |
| 4             |                                     |                                      | 360 mA              |  | WT-Series<br>U-Series<br>SmartStep | 2 x 40 pt (Fujitsu) | CJ1W-NC433   |
| 16            | Position controller                 | Mechatro-Link-II                     | 360 mA              | Position, speed and torque control; access to all drive parameters<br>Use CX-Motion NCF                | WN-Series<br>ML2                   | Mechatro-Link-II    | CJ1W-NCF71   |

## Servo Relay Unit Connection Compatibility with CJ1 Position Control Modules

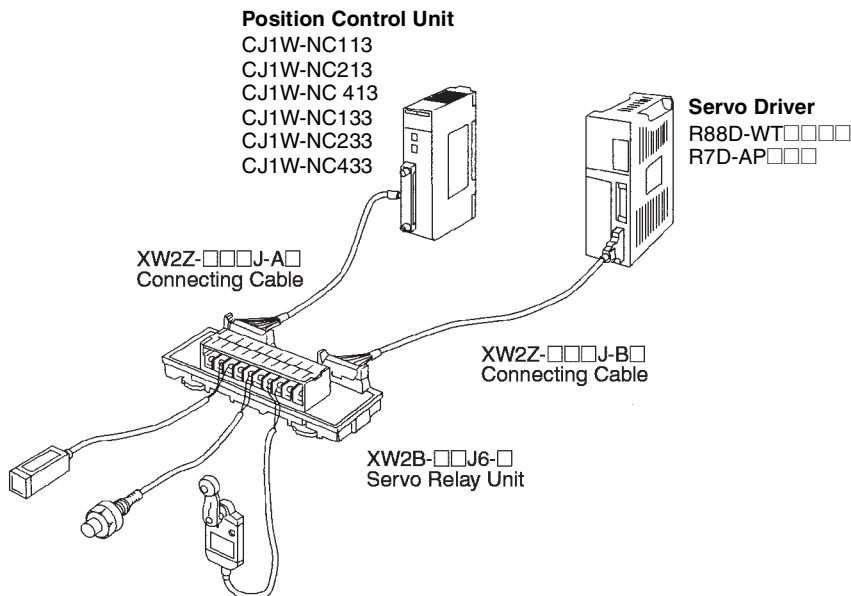

| Position control unit (PCU) | Cable between PCU and servo relay unit       | Servo relay unit | Cable between servo relay unit and servo driver | Servo driver                     |
|-----------------------------|--|------------------|---|----------------------------------|
| CJ1W-NC113                  | XW2Z-050J-A14 (0.5 m)<br>XW2Z-100J-A14 (1 m) | XW2B-20J6-1B     | XW2Z-100J-B4 (1 m)<br>XW2Z-200J-B4 (2 m)        | R88D-WT□□□□                      |
|                             | XW2Z-050J-A16 (0.5 m)<br>XW2Z-100J-A16 (1 m) | XW2B-20J6-1B     | XW2Z-100J-B5 (1 m)<br>XW2Z-200J-B5 (2 m)        | R7D-AP□□□                        |
| CJ1W-NC213<br>CJ1W-NC413    | XW2Z-050J-A15 (0.5 m)<br>XW2Z-100J-A15 (1 m) | XW2B-40J6-2B     | XW2Z-100J-B4 (1 m)<br>XW2Z-200J-B4 (2 m)        | R88D-WT□□□□                      |
|                             |  | XW2B-40J6-4A     | XW2Z-100J-B8 (1 m)<br>XW2Z-200J-B8 (2 m)        | R88D-WT□□□□<br>when using RS-422 |
|                             | XW2Z-050J-A17 (0.5 m)<br>XW2Z-100J-A17 (1 m) | XW2B-40J6-2B     | XW2Z-100J-B5 (1 m)<br>XW2Z-200J-B5 (2 m)        | R7D-AP□□□                        |
|                             |  | XW2B-40J6-4A     | XW2Z-100J-B7 (1 m)<br>XW2Z-200J-B7 (2 m)        | R7D-AP□□□<br>when using RS-422   |
| CJ1W-NC133                  | XW2Z-050J-A18 (0.5 m)<br>XW2Z-100J-A18 (1 m) | XW2B-20J6-1B     | XW2Z-100J-B4 (1 m)<br>XW2Z-200J-B4 (2 m)        | R88D-WT□□□□                      |
|                             |  | XW2B-20J6-1B     | XW2Z-100J-B5 (1 m)<br>XW2Z-200J-B5 (2 m)        | R7D-AP□□□                        |
| CJ1W-NC233<br>CJ1W-NC433    | XW2Z-050J-A19 (0.5 m)<br>XW2Z-100J-A19 (1 m) | XW2B-40J6-2B     | XW2Z-100J-B4 (1 m)<br>XW2Z-200J-B4 (2 m)        | R88D-WT□□□□                      |
|                             |  | XW2B-40J6-4A     | XW2Z-100J-B8 (1 m)<br>XW2Z-200J-B8 (2 m)        | R88D-WT□□□□<br>when using RS-422 |
|                             | XW2Z-050J-A21 (0.5 m)<br>XW2Z-100J-A21 (1 m) | XW2B-40J6-2B     | XW2Z-100J-B5 (1 m)<br>XW2Z-200J-B5 (2 m)        | R7D-AP□□□                        |
|                             |  | XW2B-40J6-4A     | XW2Z-100J-B7 (1 m)<br>XW2Z-200J-B7 (2 m)        | R7D-AP□□□<br>when using RS-422   |

## Software Documentation

| Description                    | Specification      | Model              |
|--------------------------------|--------------------|--------------------|
| CX-Position support software   | Included in CX-ONE | <b>Manual W433</b> |
| CX-Motion NCF support software | Included in CX-ONE | <b>Manual W436</b> |

# Motion Controllers

# CJ1/CS1-MC

## High-Speed PLC-Based Motion Controllers

Motion control modules for CJ1 and CS1 PLC series are equipped with MECHATROLINK-II interface that can control multiple drives through a single, high-speed data link. Message routing through multiple communication layers allows the attached drives to be configured from any point in the control network.

- PLC-based motion controller eliminates integration of motion controllers from other suppliers
- Complete digital control of drives via MECHATROLINK-II replaces SERCOS programming
- Controls a total of 32 axes (30 physical max.)
- Simplified wiring saves design time and installation and maintenance costs
- Real multi-tasking and parallel programming
- Simple to develop and modify motion programs using BASIC
- Access to the complete system from one point allows quick troubleshooting and effective time management
- Linear, circular, and helical interpolation for accurate positioning
- Electronic axes synchronization produces smooth motion
- Electronic cam profiles simulates popular mechanical ones to shorten setup
- Dedicated inputs/outputs on the controller
- All features of the W-Series servos are available

MECHATROLINK-II is a registered trademark of Yaskawa Corporation.



## MECHATROLINK-II High-Speed Motion Link

This high-speed interface replaces the costly discrete wiring required with traditional systems. Just one MECHATROLINK-II cable eliminates the need for about 15 to 18 wires for each axis, simplifying wiring, and reducing installation costs and time. It also means that maintenance and troubleshooting are minimized. With a baud rate of up to 10 MHz, the MECHATROLINK-II link provides communication cycle times of 0.5 ms for 4 axes, to 4 ms for 30 axes, ensuring fast, precise motion control.

## Ordering Information

### CJ1/CS1 Motion Controllers

| Type                  | Axes    | Output type     | Rating   | Servo series          | PLC series     | Current consumption                   | Model                |
|-----------------------|---------|-----------------|--|-----------------------|----------------|---------------------------------------|----------------------|
| Motion control module | 2 axes  | Analog          | Uses G language<br>Uses CX-Motion software   | WT-Series<br>U-Series | CS1            | 0.60 A (w/ Teaching Box: 0.80)        | <b>CS1W-MC221-V1</b> |
|                       | 4 axes  | Analog          | Uses G language<br>Uses CX-Motion software   | WT-Series<br>U-Series | CS1            | 0.70 A (w/ Teaching Box: 1.00)        | <b>CS1W-MC421-V1</b> |
|                       | 30 axes | MECHATROLINK-II | Uses CX-Motion MCH software; MECHATROLINK-II high-speed bus provides instant communications between the motion controller and Omron's W-Series servo drives<br>Functions: Electronic cam profiles and axis synchronization; Registration inputs; accesses all drive parameters; gear functions | WN-Series<br>ML2      | CS1            | 0.8 A, 5 VDC (counts as CPU bus unit) | <b>CS1W-MCH71</b>    |
|                       |         |                 |  | WN-Series<br>ML2      | CJ1-H/<br>CJ1M | 0.6 A, 5 VDC (counts as CPU bus unit) | <b>CJ1W-MCH71</b>    |

## Servo Driver Connection Cables to Motion Control Modules

| Motion Control Unit (MCU) | Control axes | Terminal block model | I/O Cable model<br>(between Terminal Block and MCU) | Servo driver |
|---------------------------|--------------|----------------------|---|--------------|
| CS1W-MC221                | 2            | XW2B-20J6-6          | XW2Z-100J-F1 (1 m)                                  | R88D-W       |
| CS1W-MC421                | 4            | XW2B-40J6-7          | XW2Z-100J-F1 (1 m)                                  |              |

## Cables Between Motion Control Unit and Servo Driver

| Servo driver | Cable length | Cable between MCU and Servo Driver |               |
|--------------|--------------|------------------------------------|---------------|
|              |              | 1 axis model                       | 2-axis model  |
| R88D-W       | 1 m          | R88A-CPW001M1                      | R88A-CPW001M2 |
|              | 2 m          | R88A-CPW002M1                      | R88A-CPW002M2 |
|              | 3 m          | R88A-CPW003M1                      | R88A-CPW003M2 |
|              | 5 m          | R88A-CPW005M1                      | R88A-CPW005M2 |

## MECHATROLINK-II Accessories and Cables

| Motion Control Unit            | Description   | Specification                | Model              |              |
|--------------------------------|---|------------------------------|--------------------|--------------|
| CJ1W-MCH71<br>CS1W-MCH71       | MECHATROLINK-II Interface Unit                        | For W-Series servo drivers   | FNY-NS115          |              |
|                                | 24 VDC I/O Module                                     | 64 inputs/64 outputs         | FNY-IO2310         |              |
|                                | Counter Module  | 2-channel reversible counter | FNY-PL2900         |              |
|                                | Pulse Output Module                                   | For pulse positioning        | FNY-PL2910         |              |
|                                | Cables for W-Series with USB connectors and ring core | 0.5 m                        |                    | FNY-W6003-A5 |
|                                |   | 1 m                          |                    | FNY-W6003-01 |
|                                |   | 3 m                          |                    | FNY-W6003-03 |
|                                |   | 5 m                          |                    | FNY-W6003-05 |
|                                |   | 10 m                         |                    | FNY-W6003-10 |
|                                |   | 20 m                         |                    | FNY-W6003-20 |
|                                |   | 30 m                         |                    | FNY-W6003-30 |
|                                | Terminating resistor for MECHATROLINK-II              | —                            |                    | FNY-W6022    |
|                                | Repeater for MECHATROLINK-II                          | —                            |                    | FNY-REP2000  |
| CX-Motion MCH support software |   |                              | Included in CX-ONE |              |
| CX-Motion support software     |   |                              | Included in CX-ONE |              |



# Soft Starters

# G3JA

Quick Link  
R002

## 3-Phase Hybrid Soft Starters Extend Motor Life

- G3JA-D Current Limit Starter for 3-phase, 6-lead motors provides internal Star-delta control and simplifies wiring. Star-delta and protective functions are included in this single unit
- G3JA-C Soft Start, Kick Start, Current Limit Start, and Soft Stop functions for 3-phase inductive motors satisfy motor performance needs for a wide range of applications. Internal protections include protection against overload and phase loss
- Smooth motor starts and stops can reduce mechanical shock, leading to longer motor life, less frequent servicing and lower maintenance costs
- Reduced power loss through hybrid control: Power supplied through a thyristor during starting or stopping and through a bypass relay during stable operation
- Slim 45-mm body saves installation space; all models have the same shape



- Electronic Thermal Overload Relay built in protects the motor from problems such as burning due to motor overload or locking. The overload class can be set to OFF, 10, 15, or 20
- Optional Auxiliary Contact Block enhances operation monitoring by providing an output of operating status
- Meets UL508; cULus listed; complies with IEC standards, etc.

## Soft Starters Ordering Information

### Current Limit Starters

| Supply voltage           | Main circuit operating current (A) |                  | Lamp load (kW)   |               |                       | HP            |               |               | Model                   |
|--------------------------|------------------------------------|------------------|------------------|---------------|-----------------------|---------------|---------------|---------------|-------------------------|
|                          | Current rating                     | Adjustable range | 200 VAC 50/60 Hz | 230 VAC 50 Hz | 380/400/415 VAC 50 Hz | 200 VAC 60 Hz | 230 VAC 60 Hz | 460 VAC 60 Hz |                         |
| 100 to 240 VAC, 50/60 Hz | 3                                  | 1 to 3           | 0.2 to 0.4       | 0.55          | 1.1                   | 0.5           | 0.5           | 0.5 to 1.5    | G3JA-D403B<br>AC100-240 |
|                          | 9                                  | 3 to 9           | 0.55 to 1.5      | 2.2           | 4                     | 0.75 to 2     | 0.75 to 2     | 1.5 to 5      | G3JA-D409B<br>AC100-240 |
|                          | 16                                 | 5.3 to 16        | 1.1 to 2.2       | 4             | 7.5                   | 1.5 to 3      | 1.5 to 5      | 5 to 10       | G3JA-D416B<br>AC100-240 |
|                          | 20                                 | 6.7 to 20        | 1.5 to 3.7       | 5.5           | 7.5                   | 2 to 5        | 2 to 5        | 5 to 10       | G3JA-D420B<br>AC100-240 |
|                          | 25                                 | 9.2 to 27.7      | 2.2 to 5.5       | 5.5           | 11                    | 3 to 7.5      | 3 to 7.5      | 7.5 to 15     | G3JA-D425B<br>AC100-240 |
|                          | 32                                 | 10.9 to 32.9     | 3.7 to 7.5       | 7.5           | 15                    | 3 to 10       | 5 to 10       | 7.5 to 20     | G3JA-D432B<br>AC100-240 |
|                          | 51                                 | 17.3 to 51.9     | 5.5 to 11        | 15            | 22                    | 5 to 15       | 7.5 to 15     | 15 to 30      | G3JA-D451B<br>AC100-240 |
|                          | 64                                 | 21.3 to 64       | 5.5 to 15        | 18.5          | 30                    | 7.5 to 20     | 7.5 to 20     | 20 to 40      | G3JA-D464B<br>AC100-240 |

## Current Limit Starters (Continued)

| Supply voltage | Main circuit operating current (A) |                  | Lamp load (kW)   |               |                       | HP            |               |               | Model                 |
|----------------|------------------------------------|------------------|------------------|---------------|-----------------------|---------------|---------------|---------------|-----------------------|
|                | Current rating                     | Adjustable range | 200 VAC 50/60 Hz | 230 VAC 50 Hz | 380/400/415 VAC 50 Hz | 200 VAC 60 Hz | 230 VAC 60 Hz | 460 VAC 60 Hz |                       |
| 24 VAC/<br>VDC | 3                                  | 1 to 3           | 0.2 to 0.4       | 0.55          | 1.1                   | 0.5           | 0.5           | 0.5 to 1.5    | G3JA-D403B<br>AC/DC24 |
|                | 9                                  | 3 to 9           | 0.55 to 1.5      | 2.2           | 4                     | 0.75 to 2     | 0.75 to 2     | 1.5 to 5      | G3JA-D409B<br>AC/DC24 |
|                | 16                                 | 5.3 to 16        | 1.1 to 2.2       | 4             | 7.5                   | 1.5 to 3      | 1.5 to 5      | 5 to 10       | G3JA-D416B<br>AC/DC24 |
|                | 20                                 | 6.7 to 20        | 1.5 to 3.7       | 5.5           | 7.5                   | 2 to 5        | 2 to 5        | 5 to 10       | G3JA-D420B<br>AC/DC24 |
|                | 25                                 | 9.2 to 27.7      | 2.2 to 5.5       | 5.5           | 11                    | 3 to 7.5      | 3 to 7.5      | 7.5 to 15     | G3JA-D425B<br>AC/DC24 |
|                | 32                                 | 10.9 to 32.9     | 3.7 to 7.5       | 7.5           | 15                    | 3 to 10       | 5 to 10       | 7.5 to 20     | G3JA-D432B<br>AC/DC24 |
|                | 51                                 | 17.3 to 51.9     | 5.5 to 11        | 15            | 22                    | 5 to 15       | 7.5 to 15     | 15 to 30      | G3JA-D451B<br>AC/DC24 |
|                | 64                                 | 21.3 to 64       | 5.5 to 15        | 18.5          | 30                    | 7.5 to 20     | 7.5 to 20     | 20 to 40      | G3JA-D464B<br>AC/DC24 |

## Multi-function Soft Starters

| Supply voltage              | Main Circuit Operating Current (A) |                  | KW at 350% of load |               |                       | HP at 350% of load |               |               | Model                   |
|-----------------------------|------------------------------------|------------------|--------------------|---------------|-----------------------|--------------------|---------------|---------------|-------------------------|
|                             | Current rating                     | Adjustable range | 200 VAC 50/60 Hz   | 230 VAC 50 Hz | 380/400/415 VAC 50 Hz | 200 VAC 60 Hz      | 230 VAC 60 Hz | 460 VAC 60 Hz |                         |
| 100 to 240 VAC,<br>50/60 Hz | 3                                  | 1 to 3           | 0.2 to 0.4         | 0.55          | 1.1                   | 0.5                | 0.5           | 0.5 to 1.5    | G3JA-C403B<br>AC100-240 |
|                             | 9                                  | 3 to 9           | 0.55 to 1.5        | 2.2           | 4                     | 0.75 to 2          | 0.75 to 2     | 1.5 to 5      | G3JA-C409B<br>AC100-240 |
|                             | 16                                 | 5.3 to 16        | 1.1 to 2.2         | 4             | 7.5                   | 1.5 to 3           | 1.5 to 5      | 5 to 10       | G3JA-C416B<br>AC100-240 |
|                             | 19                                 | 6.3 to 19        | 1.5 to 3.7         | 4             | 7.5                   | 1.5 to 5           | 2 to 5        | 5 to 10       | G3JA-C419B<br>AC100-240 |
|                             | 25                                 | 8.3 to 25        | 2.2 to 5.5         | 5.5           | 11                    | 3 to 7.5           | 3 to 7.5      | 7.5 to 15     | G3JA-C425B<br>AC100-240 |
|                             | 30                                 | 10 to 30         | 2.2 to 5.5         | 7.5           | 15                    | 3 to 7.5           | 5 to 10       | 7.5 to 20     | G3JA-C430B<br>AC100-240 |
|                             | 37                                 | 12.3 to 37       | 3.7 to 7.5         | 7.5           | 18.5                  | 5 to 10            | 5 to 10       | 10 to 25      | G3JA-C437B<br>AC100-240 |
| 24 VAC/<br>VDC              | 3                                  | 1 to 3           | 0.2 to 0.4         | 0.55          | 1.1                   | 0.5                | 0.5           | 0.5 to 1.5    | G3JA-C403B<br>AC/DC24   |
|                             | 9                                  | 3 to 9           | 0.55 to 1.5        | 2.2           | 4                     | 0.75 to 2          | 0.75 to 2     | 1.5 to 5      | G3JA-C409B<br>AC/DC24   |
|                             | 16                                 | 5.3 to 16        | 1.1 to 2.2         | 4             | 7.5                   | 1.5 to 3           | 1.5 to 5      | 5 to 10       | G3JA-C416B<br>AC/DC24   |
|                             | 19                                 | 6.3 to 19        | 1.5 to 3.7         | 4             | 7.5                   | 1.5 to 5           | 2 to 5        | 5 to 10       | G3JA-C419B<br>AC/DC24   |
|                             | 25                                 | 8.3 to 25        | 2.2 to 5.5         | 5.5           | 11                    | 3 to 7.5           | 3 to 7.5      | 7.5 to 15     | G3JA-C425B<br>AC/DC24   |
|                             | 30                                 | 10 to 30         | 2.2 to 5.5         | 7.5           | 15                    | 3 to 7.5           | 5 to 10       | 7.5 to 20     | G3JA-C430B<br>AC/DC24   |
|                             | 37                                 | 12.3 to 37       | 3.7 to 7.5         | 7.5           | 18.5                  | 5 to 10            | 5 to 10       | 10 to 25      | G3JA-C437B<br>AC/DC24   |

## Accessories

| Description             | Specification   | Model     |
|-------------------------|---|-----------|
| Fan                     | Allows increased switching frequency from 4/hr to 10/hr | G32J-CF64 |
| Auxiliary contact       | 1 NO contact  | G32J-CA10 |
| Auxiliary contacts      | 2 NO contacts   | G32J-CA20 |
| Auxiliary contact       | 1 NC contact  | G32J-CA01 |
| Auxiliary contacts      | 1 NO + 1 NC contacts                                    | G32J-CA11 |
| Terminal block adapters | Set of 2  | G32J-TA10 |

# Cam Positioner H8PS

Quick Link  
I081

## Easy-to-Use Standalone Cam Positioner Uses Encoder Input

- High-speed operation at 1600 r/min and high precision settings to 0.5°
- Advanced angle compensation function compensates for output delays
- Highly visible display with reverse-lit LCD for long-distance legibility
- Fits a 1/4 DIN panel cutout
- Front panel and surface/DIN rail mounting models (track mounting adapter optional)
- 8, 16 and 32 outputs models
- Bank function for multi-product production (8 banks)
- Use Omron absolute encoders for cam input; available with easy-to-install connector
  - E6CP-AG5C-C 256 2M for 256 pulse/rev resolution
  - E6C3-AG5C-C 360 2M for 360 pulse/rev resolution
  - E6F-AG5C-C 720 2M for 720 pulse/rev resolution
- IP40 front panel rating; waterproof and protective covers available



## Specifications

- Supply voltage: 24 VDC
- Inputs: Encoder input: Connection to a dedicated absolute encoder
  - External inputs: bank inputs 1/2/4, origin input, start input (16-/32-output models)
- Control output:
  - 8-output Models: 8 cam outputs, 1 RUN output, 1 pulse output
  - 16-output Models: 16 cam outputs, 1 RUN output, 1 pulse output
  - 32-output Models: 32 cam outputs, 1 RUN output, 1 pulse output
- Output ratings:
  - Cam outputs, RUN output: NPN or PNP open collector, 100 mA at 30 VDC
  - Pulse outputs: NPN or PNP open collector, 30 mA at 30 VDC
- Dimensions: 96 H x 96 W x 65 D mm

## Ordering Information

### Cam Positioners

| Number of outputs | Mounting method              | Dimensions<br>L x W x H mm | Output type        | Bank function | Model      |
|-------------------|------------------------------|----------------------------|--------------------|---------------|------------|
| 8 outputs         | Panel mounting               | 96 x 96 x 67.5             | NPN open collector | None          | H8PS-8B    |
|                   |                              |                            | PNP open collector | None          | H8PS-8BP   |
| 8 outputs         | DIN rail or surface mounting | 96 x 96 x 60.6             | NPN open collector | None          | H8PS-8BF   |
|                   |                              |                            | PNP open collector | None          | H8PS-8BFP  |
| 16 outputs        | Panel mounting               | 96 x 96 x 67.5             | NPN open collector | None          | H8PS-16B   |
|                   |                              |                            | PNP open collector | None          | H8PS-16BP  |
| 16 outputs        | DIN rail or surface mounting | 96 x 96 x 60.6             | NPN open collector | None          | H8PS-16BF  |
|                   |                              |                            | PNP open collector | None          | H8PS-16BFP |
| 32 outputs        | Panel mounting               | 96 x 96 x 67.5             | NPN open collector | None          | H8PS-32B   |
|                   |                              |                            | PNP open collector | None          | H8PS-32BP  |
| 32 outputs        | DIN rail or surface mounting | 96 x 96 x 60.6             | NPN open collector | None          | H8PS-32BF  |
|                   |                              |                            | PNP open collector | None          | H8PS-32BFP |

## Absolute Encoders and Couplers

Full descriptions are listed under Rotary Encoders elsewhere in this catalog.

| Type     | Resolution | Shaft diameter | Cable length | Encoder Model      |
|----------|------------|----------------|--------------|--------------------|
| Economy  | 256        | 6 mm           | 2 m          | E6CP-AG5C-C 256 2M |
| Standard | 256        | 8 mm           | 1 m          | E6C3-AG5C-C 256 1M |
|          | 256        | 8 mm           | 2 m          | E6C3-AG5C-C 256 2M |
|          | 360        | 8 mm           | 2 m          | E6C3-AG5C-C 360 2M |
|          | 720        | 8 mm           | 2 m          | E6C3-AG5C-C 720 2M |
|          | Rugged     | 256            | 10 mm        | 2 m                |
| Rugged   | 360        | 10 mm          | 2 m          | E6F-AG5C-C 360 2M  |
|          | 720        | 10 mm          | 2 m          | E6F-AG5C-C 720 2M  |

## Accessories

| Description                 | Specification                          | Model        |
|-----------------------------|--|--------------|
| Discrete wire output cable  | 2 m length                             | Y92S-41-200  |
| Connector type output cable | 2 m length                             | E5ZE-CBL200  |
| Support software            | CD-ROM                                 | H8PS-SOFT-V1 |
| Parallel input adapter      | Two units can operate in parallel      | Y92C-30      |
| Protective cover            | Hard plastic, fits H8PS                | Y92A-96B     |
| Watertight cover            | NEMA 4 protection for H8PS front panel | Y92A-96N     |
| DIN-rail mounting adapter   | Use with H8PS-□BF□ models              | Y92F-91      |
| Encoder extension cable     | 5 m length (for E5CP, E6C3-A, E6F-A)   | E69-DF5      |

# Cam Positioner C200H-CP114



## PLC-Based Cam Positioner Uses Resolver Input

- Simulates mechanical cam switches, integrates control into Omron's CS1 Series PLC
- Fast operation at 800 r/min and accurate settings to 1°
- Front panel origin adjustment from 1° to 359°
- Setting/display unit panels mounts for easy setup and monitoring
- Bank function for multi-product production (8 banks each hold 48 data points)
- EPROM memory backs up bank and data settings
- CW/CCW direction, cam data protection and setting protection set by rear mounted DIP switches

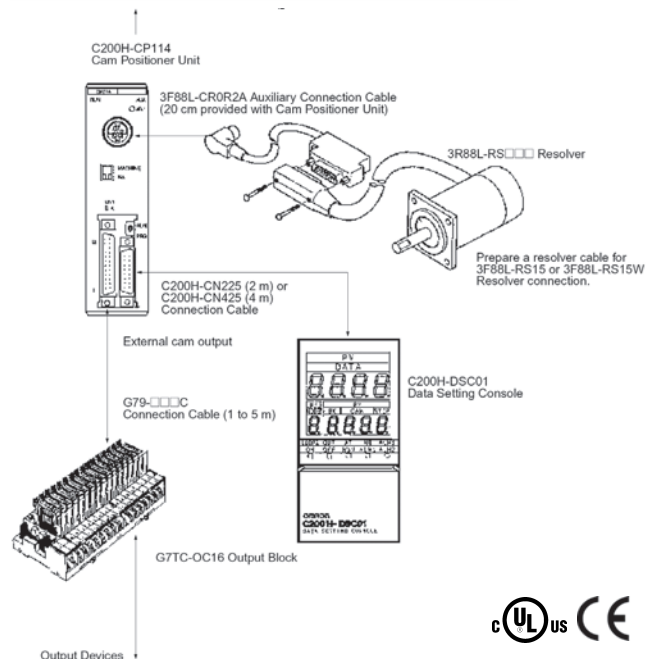
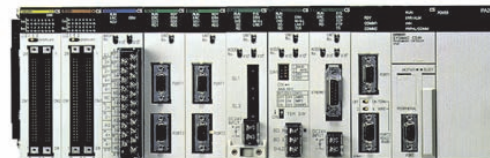

## Specifications

- Supply voltage: 5 VDC from PLC
- Inputs: Resolver: 800 rpm resolution
- Angle detection cycle: 200 μs at 5 kHz sampling frequency
- Control output: 16 external NPN transistor outputs; can be assigned to internal outputs
  - 32 internal only outputs
- Number of ON/OFF control operations: 7 outputs per cam max.
- Bank function: 8 banks, each stores 48 points of cam output data

## Cam Positioner

| Number of inputs | Number of outputs                                       | Mounting method  | Dimensions H x W x D mm | Output type/rating  | Bank function | Model       |
|------------------|---|------------------|-------------------------|---|---------------|-------------|
| 1 resolver input | 48 outputs:<br>16 internal/external<br>32 internal only | CS1 PLC mounting | 130 x 34.5 x 101        | NPN open collector/<br>100 mA at 24 VDC;<br>8 points max. ON simultaneously | 8 banks       | C200H-CP114 |

## Resolvers

Use Omron's 3F88L-RS17 or 3F88L-RS15 series resolvers or commercially available models.

# Rotary Encoders—Absolute

## E6C3-A

Quick Link

P060A

### Water Resistant Encoder for Tough Environments

- IP65f drip-proof, oil-proof construction with sealed bearing
- 8 mm stainless steel shaft provides superior shaft loading performance: Radial: 8 kg-f; Axial: 5.1 kg-f
- NPN, or PNP open collector or voltage outputs
- Optimum angle control when combined with cam positioner (stand-alone H8PS or PLC-based) or encoder-input PLC position control modules
- Response frequency: 20 kHz max., 5,000 rpm max.
- Pre-wired with 1 meter cable; 2 meter cable available, connector version available for direct connection to an H8PS Cam Positioning unit



### Absolute Rotary Encoders

When ordering, specify the resolution in addition to the model number (example: E6C3-AG5C 360P/R 1M).

| Size              | Shaft                             | Supply voltage | Output configuration      | Output code | Resolution (pulses/rotation) | Connection method                     | Model                |
|-------------------|-----------------------------------|----------------|---------------------------|-------------|------------------------------|---------------------------------------|----------------------|
| 50 dia. x 43 D mm | 8 dia. x 15 L mm, stainless steel | 12 to 24 VDC   | NPN open-collector output | Gray        | 256, 360, 720                | 2 m connector for H8PS Cam Positioner | <b>E6C3-AG5C-C</b>   |
|                   |                                   |                |                           |             | 256, 360, 720, 1,024         |                                       | Pre-wired, 1 m cable |
|                   |                                   |                |                           | Binary      | 32, 40                       | <b>E6C3-AN5C</b>                      |                      |
|                   |                                   |                | BCD                       | 6, 8, 12    | <b>E6C3-AB5C</b>             |                                       |                      |
|                   |                                   |                | PNP open-collector output | Gray        | 256, 360, 720, 1,024         | <b>E6C3-AG5B</b>                      |                      |
|                   |                                   |                |                           | Binary      | 32, 40                       | <b>E6C3-AN5B</b>                      |                      |
|                   |                                   | BCD            |                           | 6, 8, 12    | <b>E6C3-AB5B</b>             |                                       |                      |
|                   |                                   | 5 VDC          | Voltage output            | Binary      | 256                          | <b>E6C3-AN1E</b>                      |                      |
|                   |                                   |                |                           |             |                              | 12 VDC                                | <b>E6C3-AN2E</b>     |

# Rotary Encoders—Absolute E6CP



## Low-Cost Absolute Encoder, 50 mm Diameter

- High-precision detection of automatic machine timing, also ideal for robot limit signals
- Absolute encoder performance at the cost of an incremental encoder
- Gray code output eliminates reading mistakes
- Lightweight, plastic body construction, IP50 enclosure rating
- Shaft loading: Radial: 3 kg-f; Axial: 2 kg-f
- Open collector output
- Response frequency: 5 kHz max., 1,000 rpm max.
- Pre-wired with 2-meter cable, connector version available for direct connection to an H8PS Cam Positioning unit



## Absolute Rotary Encoders

| Size              | Shaft            | Power supply voltage | Output configuration  | Output code | Resolution (pulses/rotation) | Connection method                                | Model       |
|-------------------|------------------|----------------------|-----------------------|-------------|------------------------------|--|-------------|
| 50 dia. x 55 D mm | 6 dia. x 10 L mm | 5 to 12 VDC          | Open-collector output | Gray        | 256 (8-bit)                  | Pre-wired, 2 m cable                             | E6CP-AG3C   |
|                   |                  | 12 to 24 VDC         |                       |             |                              |  | E6CP-AG5C   |
|                   |                  |                      |                       |             |                              | 2 m cable with connector for H8PS Cam Positioner | E6CP-AG5C-C |



## Rotary Encoders—Absolute

# E6F-A

Quick Link

F031

### Rugged Encoder for High-Precision Detection

- 10 mm stainless steel shaft and rugged construction provide the highest shaft loading among Omron encoders: Radial: 12 kg-f, Thrust: 5 kg-f
- IP65f water and oil-proof construction
- High response speed for faster control: Gray code: 20 kHz; BCD: 10 kHz, 5,000 rpm max.
- Combine with H8PS Cam Positioner or PLC encoder input module for optimum angle control
- Pre-wired with 2-meter cable, connector version available for direct connection to an H8PS Cam Positioning unit



## Absolute Rotary Encoders

When ordering, specify the resolution in addition to the model number (example: E6F-AG5C 256 P/R).

| Size                 | Shaft             | Power supply voltage | Output configuration | Output code | Resolution (pulses/ rotation) | Connection method                                | Model             |
|----------------------|-------------------|----------------------|----------------------|-------------|-------------------------------|--|-------------------|
| 60 mm dia. x 65 D mm | 10 dia. x 20 L mm | 5 to 12 VDC          | NPN open collector   | BCD         | 360                           | Pre-wired 2 m cable                              | <b>E6F-AB3C</b>   |
|                      |                   |                      | NPN open collector   | BCD         | 360                           | Pre-wired 2 m cable                              | <b>E6F-AB5C</b>   |
|                      |                   | 12 to 24 VDC         | PNP open collector   | BCD         | 360                           | Pre-wired 2 m cable                              | <b>E6F-AB5B</b>   |
|                      |                   |                      | NPN open collector   | Gray code   | 256, 360, 720                 | 2 m cable with connector for H8PS Cam Positioner | <b>E6F-AG5C-C</b> |
|                      |                   |                      | NPN open collector   |             | 256, 360, 720,                | Pre-wired 2 m cable                              | <b>E6F-AG5C</b>   |
|                      |                   |                      | PNP open collector   |             | 1,024                         |  | <b>E6F-AG5B</b>   |

# Rotary Encoders—Incremental

## E6A2-C

Quick Link  
F020

### Miniature Positioning Solution for Tight Spaces

- High response frequency and noise immunity make encoders ideal for factory automation applications with 10 to 500 pulses/revolution
- Space saving enclosure: 25 mm dia.
- 4 mm shaft with load rating of: Radial: 1 kg-f; Axial: 0.5 kg-f
- Open collector output, other output types available
- Output phases: A/A, B and A, B, Z (reversible) are available
- Response frequency: 20 kHz max., 5,000 rpm max.
- Enclosure rating: IP50
- Pre-wired with 0.5 meter cable



## Incremental Rotary Encoders

| Size              | Shaft            | Supply voltage | Output configuration           | Resolution (pulses/ revolution) | Model                |
|-------------------|------------------|----------------|--------------------------------|---------------------------------|----------------------|
| 25 dia. x 31 D mm | 4 dia. x 10 L mm | 12 to 24 VDC   | NPN open collector, 30 mA max. | 100                             | E6A2-CW5C 100P/R 05M |
|                   |                  |                |                                | 200                             | E6A2-CW5C 200P/R 05M |

# Rotary Encoders—Incremental

## E6B2-C

Quick Link

F022

### General-Purpose Compact Encoders

- High resolution models (up to 2000 pulses per revolution available) substantially improve measuring accuracy
- Rugged construction: 6 mm shaft with load rating of: Radial: 3 kg-f; Axial: 2 kg-f
- Output phases: A, B, Z (reversible)
- Response frequency: up to 100 kHz max., 6,000 rpm max.
- Protected against short-circuit and reversed connections for highly reliable operation
- Available with NPN and PNP open collector, voltage and line driver outputs
- Enclosure rating: IP50
- Pre-wired with 0.5- or 2-meter cables



### Incremental Rotary Encoders

| Size                 | Shaft            | Supply voltage | Output configuration  | Resolution (pulses/ revolution) | Cable length | Model                  |
|----------------------|------------------|----------------|---|---------------------------------|--------------|------------------------|
| 40 mm dia. x 44 D mm | 6 dia. x 15 L mm | 12 to 24 VDC   | NPN open collector, 35 mA max.  | 100                             | 2 m          | E6B2-CWZ6C 100P/R 2M   |
|                      |                  |                |   | 200                             | 2 m          | E6B2-CWZ6C 200P/R 2M   |
|                      |                  |                |   | 360                             | 0.5 m        | E6B2-CWZ6C 360P/R 05M  |
|                      |                  |                |   | 360                             | 2 m          | E6B2-CWZ6C 360P/R 2M   |
|                      |                  |                |   | 500                             | 2 m          | E6B2-CWZ6C 500P/R 2M   |
|                      |                  |                |   | 600                             | 2 m          | E6B2-CWZ6C 600P/R 2M   |
|                      |                  |                |   | 1000                            | 0.5 m        | E6B2-CWZ6C 1000P/R 05M |
|                      |                  |                |   | 1000                            | 2 m          | E6B2-CWZ6C 1000P/R 2M  |
|                      |                  | 5 VDC          | Line driver:<br>High: -20 mA or 2.5 V min.<br>Low: +20 mA or 0.5 V max. | 1000                            | 0.5 m        | E6B2-CWZ1X 1000P/R 05M |

# Rotary Encoders—Incremental E6C3-C



## Water Resistant Incremental Encoder for Tough Environments

- High resolution solutions from 100 to 3600 pulses/revolution
- IP65f drip-proof, oil-proof construction with sealed bearing
- 8 mm stainless steel shaft provides a load rating of: Radial: 88 kg-f; Axial: 5 kg-f
- Complementary outputs simplify interfacing to NPN or PNP input devices
- Output phases: A, B and Z (reversible)
- Response frequency: 125 kHz max. (65 kHz for Z-phase), 5,000 rpm max.
- Surge protection built in
- Voltage and line driver output versions available
- Pre-wired with 1 meter cable, 2 meter cable is available



## Incremental Rotary Encoders-Complementary NPN and PNP Outputs

| Size              | Shaft                             | Supply voltage | Output configuration                                  | Resolution (pulses/ revolution) | Model                  |
|-------------------|-----------------------------------|----------------|---|---------------------------------|------------------------|
| 50 dia. x 43 D mm | 8 dia. x 15 L mm, stainless steel | 12 to 24 VDC   | <p>Complementary output (NPN and PNP), 35 mA max.</p> | 100                             | E6C3-CWZ5GH 100P/R 1M  |
|                   |                                   |                |   | 200                             | E6C3-CWZ5GH 200P/R 1M  |
|                   |                                   |                |   | 360                             | E6C3-CWZ5GH 360P/R 1M  |
|                   |                                   |                |   | 500                             | E6C3-CWZ5GH 500P/R 1M  |
|                   |                                   |                |   | 720                             | E6C3-CWZ5GH 720P/R 1M  |
|                   |                                   |                |   | 800                             | E6C3-CWZ5GH 800P/R 1M  |
|                   |                                   |                |   | 1000                            | E6C3-CWZ5GH 1000P/R 1M |
|                   |                                   |                |   | 2048                            | E6C3-CWZ5GH 2048P/R 1M |
|                   |                                   |                |   | 2500                            | E6C3-CWZ5GH 2500P/R 1M |
|                   |                                   |                |   | 3600                            | E6C3-CWZ5GH 3600P/R 1M |

## Rotary Encoders—Incremental

# E6D

Quick Link

F030

### Rugged, High-Resolution Encoder

- Resolution as high as 6,000 pulses/revolution in a rugged construction
- Outputs: A, B (reversible) and Z (zero)
- 55 mm diameter housing
- Superb reliability and accuracy: phase error as small as 1/4T ±0.07T
- High response frequency of 200 kHz, 12,000 rpm max.
- 6 mm shaft with load rating of: radial: 5 kg-f; axial: 3 kg-f



## Incremental Rotary Encoders

Add resolution (pulses/revolution) before P/R in the model number.

| Size                 | Shaft            | Supply voltage | Output configuration           | Resolution (pulses/ revolution)  | Cable length | Model                |
|----------------------|------------------|----------------|--------------------------------|--|--------------|----------------------|
| 40 mm dia. x 44 D mm | 6 dia. x 15 L mm | 12 VDC         | NPN open collector, 35 mA max. | 720, 800, 1000, 1024, 1200, 1500, 1800, 2000, 2048, 2500, 3000, 3200, 3600, 4096, 5000, 6000 | 0.5 m        | E6D-CWZ2C□□□□P/R 05M |
|                      |                  | 5 VDC          |                                |  | 0.5 m        | E6D-CWZ1E□□□□P/R 05M |

## Rotary Encoders—Incremental

# E6F-C

Quick Link

Q037

### Rugged Encoder with Strongest Shaft

- 10 mm stainless steel shaft and rugged construction provides the highest shaft loading among Omron encoders: Radial: 12 kg-f, Thrust: 5 kg-f
- IP65f water- and oil-proof construction
- 60 mm diameter housing
- Complementary output for longer cable length extension
- High response frequency of 83 kHz, 5,000 rpm max.
- Output load short-circuit protection to reduce risks from incorrect wiring
- Pre-wired 2 meter cable



## Incremental Rotary Encoders

Add resolution (pulses/revolution) before P/R in the model number.

| Size                 | Shaft             | Supply voltage | Output configuration              | Resolution (pulses/ revolution) | Cable length | Model           |
|----------------------|-------------------|----------------|-----------------------------------|---------------------------------|--------------|-----------------|
| 60 mm dia. x 65 D mm | 10 dia. x 20 L mm | 12 to 24 VDC   | Complementary NPN and PNP, ±30 mA | 100, 200, 360, 500, 600, 1000   | 2 m          | E6F-CWZ5GP/R 2M |

# Terms and Conditions of Sale

- Offer; Acceptance.** These terms and conditions (these "Terms") are deemed part of all quotes, agreements, purchase orders, acknowledgments, price lists, catalogs, manuals, brochures and other documents, whether electronic or in writing, relating to the sale of products or services (collectively, the "Products") by Omron Electronics LLC and its subsidiary companies ("Omron"). Omron objects to any terms or conditions proposed in Buyer's purchase order or other documents which are inconsistent with, or in addition to, these Terms.
- Prices; Payment Terms.** All prices stated are current, subject to change without notice by Omron. Omron reserves the right to increase or decrease prices on any unshipped portions of outstanding orders. Payments for Products are due net 30 days unless otherwise stated in the invoice.
- Discounts.** Cash discounts, if any, will apply only on the net amount of invoices sent to Buyer after deducting transportation charges, taxes and duties, and will be allowed only if (i) the invoice is paid according to Omron's payment terms and (ii) Buyer has no past due amounts.
- Interest.** Omron, at its option, may charge Buyer 1-1/2% interest per month or the maximum legal rate, whichever is less, on any balance not paid within the stated terms.
- Orders.** Omron will accept no order less than \$200 net billing.
- Governmental Approvals.** Buyer shall be responsible for, and shall bear all costs involved in, obtaining any government approvals required for the importation or sale of the Products.
- Taxes.** All taxes, duties and other governmental charges (other than general real property and income taxes), including any interest or penalties thereon, imposed directly or indirectly on Omron or required to be collected directly or indirectly by Omron for the manufacture, production, sale, delivery, importation, consumption or use of the Products sold hereunder (including customs duties and sales, excise, use, turnover and license taxes) shall be charged to and remitted by Buyer to Omron.
- Financial.** If the financial position of Buyer at any time becomes unsatisfactory to Omron, Omron reserves the right to stop shipments or require satisfactory security or payment in advance. If Buyer fails to make payment or otherwise comply with these Terms or any related agreement, Omron may (without liability and in addition to other remedies) cancel any unshipped portion of Products sold hereunder and stop any Products in transit until Buyer pays all amounts, including amounts payable hereunder, whether or not then due, which are owing to it by Buyer. Buyer shall in any event remain liable for all unpaid accounts.
- Cancellation; Etc.** Orders are not subject to rescheduling or cancellation unless Buyer indemnifies Omron against all related costs or expenses.
- Force Majeure.** Omron shall not be liable for any delay or failure in delivery resulting from causes beyond its control, including earthquakes, fires, floods, strikes or other labor disputes, shortage of labor or materials, accidents to machinery, acts of sabotage, riots, delay in or lack of transportation or the requirements of any government authority.
- Shipping; Delivery.** Unless otherwise expressly agreed in writing by Omron:
  - Shipments shall be by a carrier selected by Omron; Omron will not drop ship except in "break down" situations.
  - Such carrier shall act as the agent of Buyer and delivery to such carrier shall constitute delivery to Buyer;
  - All sales and shipments of Products shall be FOB shipping point (unless otherwise stated in writing by Omron), at which point title and risk of loss shall pass from Omron to Buyer; provided that Omron shall retain a security interest in the Products until the full purchase price is paid;
  - Delivery and shipping dates are estimates only; and
  - Omron will package Products as it deems proper for protection against normal handling and extra charges apply to special conditions.
- Claims.** Any claim by Buyer against Omron for shortage or damage to the Products occurring before delivery to the carrier must be presented in writing to Omron within 30 days of receipt of shipment and include the original transportation bill signed by the carrier noting that the carrier received the Products from Omron in the condition claimed.
- Warranties.** (a) **Exclusive Warranty.** Omron's exclusive warranty is that the Products will be free from defects in materials and workmanship for a period of twelve months from the date of sale by Omron (or such other period expressed in writing by Omron). Omron disclaims all other warranties, express or implied. (b) **Limitations.** OMRON MAKES NO WARRANTY OR REPRESENTATION, EXPRESS OR IMPLIED, ABOUT NON-INFRINGEMENT, MERCHANTABILITY OR FITNESS FOR A PARTICULAR PURPOSE OF THE PRODUCTS. BUYER ACKNOWLEDGES THAT IT ALONE HAS DETERMINED THAT THE PRODUCTS WILL SUITABLY MEET THE REQUIREMENTS OF THEIR INTENDED USE. Omron further disclaims all warranties and responsibility of any type for claims or expenses based on infringement by the Products or otherwise of any intellectual property right. (c) **Buyer Remedy.** Omron's sole obligation hereunder shall be, at Omron's election, to (i) replace (in the form originally shipped with Buyer responsible for labor charges for removal or replacement thereof) the non-complying Product, (ii) repair the non-complying Product, or (iii) repay or credit Buyer an amount equal to the purchase price of the non-complying Product; provided that in no event shall Omron be responsible for warranty, repair, indemnity or any other claims or expenses regarding the Products unless Omron's analysis confirms that the Products were properly handled, stored, installed and maintained and not subject to contamination, abuse, misuse or inappropriate modification. Return of any Products by Buyer must be approved in writing by Omron before shipment. Omron Companies shall not be liable for the suitability or unsuitability or the results from the use of Products in combination with any electrical or electronic components, circuits, system assemblies or any other materials or substances or environments. Any advice, recommendations or information given orally or in writing, are not to be construed as an amendment or addition to the above warranty. See <http://www.omron247.com> or contact your Omron representative for published information.
- Limitation on Liability; Etc.** OMRON COMPANIES SHALL NOT BE LIABLE FOR SPECIAL, INDIRECT, INCIDENTAL, OR CONSEQUENTIAL DAMAGES, LOSS OF PROFITS OR PRODUCTION OR COMMERCIAL LOSS IN ANY WAY CONNECTED WITH THE PRODUCTS, WHETHER SUCH CLAIM IS BASED IN CONTRACT, WARRANTY, NEGLIGENCE OR STRICT LIABILITY. Further, in no event shall liability of Omron Companies exceed the individual price of the Product on which liability is asserted.
- Indemnities.** Buyer shall indemnify and hold harmless Omron Companies and their employees from and against all liabilities, losses, claims, costs and expenses (including attorney's fees and expenses) related to any claim, investigation, litigation or proceeding (whether or not Omron is a party) which arises or is alleged to arise from Buyer's acts or omissions under these Terms or in any way with respect to the Products. Without limiting the foregoing, Buyer (at its own expense) shall indemnify and hold harmless Omron and defend or settle any action brought against such Companies to the extent based on a claim that any Product made to Buyer specifications infringed intellectual property rights of another party.
- Property; Confidentiality.** Any intellectual property in the Products is the exclusive property of Omron Companies and Buyer shall not attempt to duplicate it in any way without the written permission of Omron. Notwithstanding any charges to Buyer for engineering or tooling, all engineering and tooling shall remain the exclusive property of Omron. All information and materials supplied by Omron to Buyer relating to the Products are confidential and proprietary, and Buyer shall limit distribution thereof to its trusted employees and strictly prevent disclosure to any third party.
- Export Controls.** Buyer shall comply with all applicable laws, regulations and licenses regarding (i) export of products or information; (ii) sale of products to "forbidden" or other proscribed persons; and (iii) disclosure to non-citizens of regulated technology or information.
- Miscellaneous.** (a) **Waiver.** No failure or delay by Omron in exercising any right and no course of dealing between Buyer and Omron shall operate as a waiver of rights by Omron. (b) **Assignment.** Buyer may not assign its rights hereunder without Omron's written consent. (c) **Law.** These Terms are governed by the law of the jurisdiction of the home office of the Omron company from which Buyer is purchasing the Products (without regard to conflict of law principles). (d) **Amendment.** These Terms constitute the entire agreement between Buyer and Omron relating to the Products, and no provision may be changed or waived unless in writing signed by the parties. (e) **Severability.** If any provision hereof is rendered ineffective or invalid, such provision shall not invalidate any other provision. (f) **Setoff.** Buyer shall have no right to set off any amounts against the amount owing in respect of this invoice. (g) **Definitions.** As used herein, "including" means "including without limitation"; and "Omron Companies" (or similar words) mean Omron Corporation and any direct or indirect subsidiary or affiliate thereof.

## Certain Precautions on Specifications and Use

- Suitability of Use.** Omron Companies shall not be responsible for conformity with any standards, codes or regulations which apply to the combination of the Product in the Buyer's application or use of the Product. At Buyer's request, Omron will provide applicable third party certification documents identifying ratings and limitations of use which apply to the Product. This information by itself is not sufficient for a complete determination of the suitability of the Product in combination with the end product, machine, system, or other application or use. Buyer shall be solely responsible for determining appropriateness of the particular Product with respect to Buyer's application, product or system. Buyer shall take application responsibility in all cases but the following is a non-exhaustive list of applications for which particular attention must be given:
  - Outdoor use, uses involving potential chemical contamination or electrical interference, or conditions or uses not described in this document.
  - Use in consumer products or any use in significant quantities.
  - Energy control systems, combustion systems, railroad systems, aviation systems, medical equipment, amusement machines, vehicles, safety equipment, and installations subject to separate industry or government regulations.
  - Systems, machines and equipment that could present a risk to life or property. Please know and observe all prohibitions of use applicable to this Product.

NEVER USE THE PRODUCT FOR AN APPLICATION INVOLVING SERIOUS RISK TO LIFE OR PROPERTY OR IN LARGE QUANTITIES WITHOUT ENSURING THAT THE SYSTEM AS A WHOLE HAS BEEN DESIGNED TO ADDRESS THE RISKS, AND THAT THE OMRON'S PRODUCT IS PROPERLY RATED AND INSTALLED FOR THE INTENDED USE WITHIN THE OVERALL EQUIPMENT OR SYSTEM.
- Programmable Products.** Omron Companies shall not be responsible for the user's programming of a programmable Product, or any consequence thereof.
- Performance Data.** Data presented in Omron Company websites, catalogs and other materials is provided as a guide for the user in determining suitability and does not constitute a warranty. It may represent the result of Omron's test conditions, and the user must correlate it to actual application requirements. Actual performance is subject to the Omron's Warranty and Limitations of Liability.
- Change in Specifications.** Product specifications and accessories may be changed at any time based on improvements and other reasons. It is our practice to change part numbers when published ratings or features are changed, or when significant construction changes are made. However, some specifications of the Product may be changed without any notice. When in doubt, special part numbers may be assigned to fix or establish key specifications for your application. Please consult with your Omron's representative at any time to confirm actual specifications of purchased Product.
- Errors and Omissions.** Information presented by Omron Companies has been checked and is believed to be accurate; however, no responsibility is assumed for clerical, typographical or proofreading errors or omissions.

Complete "Terms and Conditions of Sale" for product purchase and use are on Omron's website at [www.omron.com/oei](http://www.omron.com/oei) – under the "About Us" tab, in the Legal Matters section.

**ALL DIMENSIONS SHOWN ARE IN MILLIMETERS.**

To convert millimeters into inches, multiply by 0.03937. To convert grams into ounces, multiply by 0.03527.

---

**OMRON**<sup>®</sup>**OMRON ELECTRONICS LLC**

1 Commerce Drive  
Schaumburg, IL 60173  
Tel: 847.843.7900

For U.S. technical support or other  
inquiries: 800.556.6766

**OMRON CANADA, INC.**

885 Milner Avenue  
Toronto, Ontario M1B 5V8  
Tel: 416.286.6465

**MEXICO SALES OFFICES**

Mexico, D.F. (52) 555 660 31 44  
Ciudad Juárez (52) 656 623 70 83  
Monterrey, N.L. (52) 818 377 42 81  
Mexicali, B.C. (52) 686 838 01 15

**BRAZIL SALES OFFICES**

Sao Paulo (55) 11 2101 6300

**ARGENTINA SALES OFFICES**

Cono Sur (54) 11 4787 1129

**CHILE SALES OFFICES**

Santiago (56) 2206 4592

**OTHER LATIN AMERICAN SALES**

[mela@omron.com](mailto:mela@omron.com)

**OMRON ON-LINE**

**Global –**  
[www.omron.com](http://www.omron.com)

**USA –**  
[www.omron247.com](http://www.omron247.com)

**Canada –**  
[www.omron.ca](http://www.omron.ca)

**Brazil –**  
[www.omron.com.br](http://www.omron.com.br)