

阅读申明

- 1.本站收集的数据手册和产品资料都来自互联网，版权归原作者所有。如读者和版权方有任何异议请及时告之，我们将妥善解决。
- 2.本站提供的中文数据手册是英文数据手册的中文翻译，其目的是协助用户阅读，该译文无法自动跟随原稿更新，同时也可能存在翻译上的不当。建议读者以英文原稿为参考以便获得更精准的信息。
- 3.本站提供的产品资料，来自厂商的技术支持或者使用者的心得体会等，其内容可能存在描述上的差异，建议读者做出适当判断。
- 4.如需与我们联系，请发邮件到marketing@iczoom.com，主题请标有“数据手册”字样。

Read Statement

1. The datasheets and other product information on the site are all from network reference or other public materials, and the copyright belongs to the original author and original published source. If readers and copyright owners have any objections, please contact us and we will deal with it in a timely manner.
2. The Chinese datasheets provided on the website is a Chinese translation of the English datasheets. Its purpose is for reader's learning exchange only and do not involve commercial purposes. The translation cannot be automatically updated with the original manuscript, and there may also be improper translations. Readers are advised to use the English manuscript as a reference for more accurate information.
3. All product information provided on the website refer to solutions from manufacturers' technical support or users the contents may have differences in description, and readers are advised to take the original article as the standard.
4. If you have any questions, please contact us at marketing@iczoom.com and mark the subject with "Datasheets" .

Motion and Motor Control Solutions



Reliable, accurate positioning and motion control for seamless industrial automation

- » Stand-alone open platform motion controller
- » Servo drives and motors
 - » Energy-saving AC inverters
- » PLC-based motion and position controllers
 - » Cam positioners and rotary encoders

Contents

Selection guide		I-ii
TJ1- Servo drives and motors	Trajexia Motion Controller,	I-1
W-Series	Full-featured servo system; advanced setup tools, diagnostics, and comm.	I-5
SmartStep	Economical, easy-to-use servo system ideal for stepper upgrades	I-12
Inverters		
3G3JV	Compact AC inverter for simple motor control	I-20
3G3MV	Compact inverter offers Loop Vector and V/Hz control	I-22
G5+	Flux vector inverter, 600V, constant torque (Canada only)	I-25
P5+	Powerful 600V variable torque inverter (Canada only)	I-28
RV	Flux vector inverter, general-purpose and high-end applications (Canada only)	I-30
Position controllers/high-speed counters		
CJ1/CS1- NC/-CT/ -HC	PLC-based accurate positioning control	I-33
Motion controllers		
CJ1/CS1 -MC	High-speed PLC-based motion controllers	I-37
Soft starters		
G3JA	3-phase hybrid soft starters extend motor life	I-39
Cam positioners		
H8PS	Stand-alone cam positioner uses encoder input	I-41
C200H- CP114	PLC-based cam positioner uses resolver input	I-43

Rotary encoders		
Absolute encoders		
E6C3-A	Water resistant encoder for tough environments	I-44
E6CP	Low-cost absolute encoder, 50 mm diameter	I-45
E6F-A	Rugged encoder for high-precision detections	I-46
Incremental encoders		
E6A2-C	Miniature positioning solution for tight spaces	I-47
E6B2-C	General-purpose compact encoders	I-48
E6C3-C	Water resistant encoder for tough environments	I-49
E6D	Rugged, high-resolution encoder	I-50
E6F-C	Rugged encoder with strong shaft	I-50

Selection Guide

Servo Drives and Motors

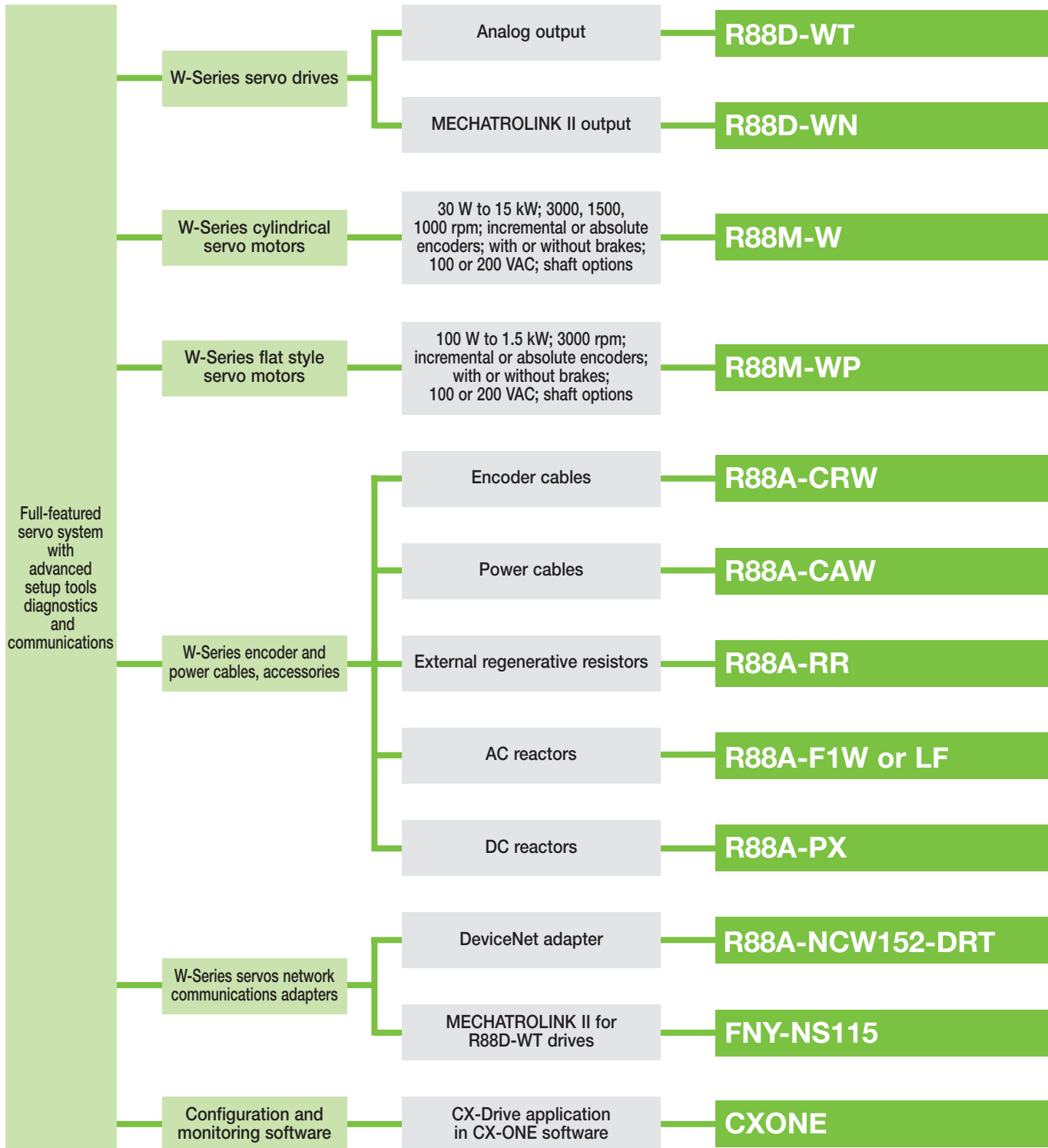

Selection Guide

Servo Drives and Motors

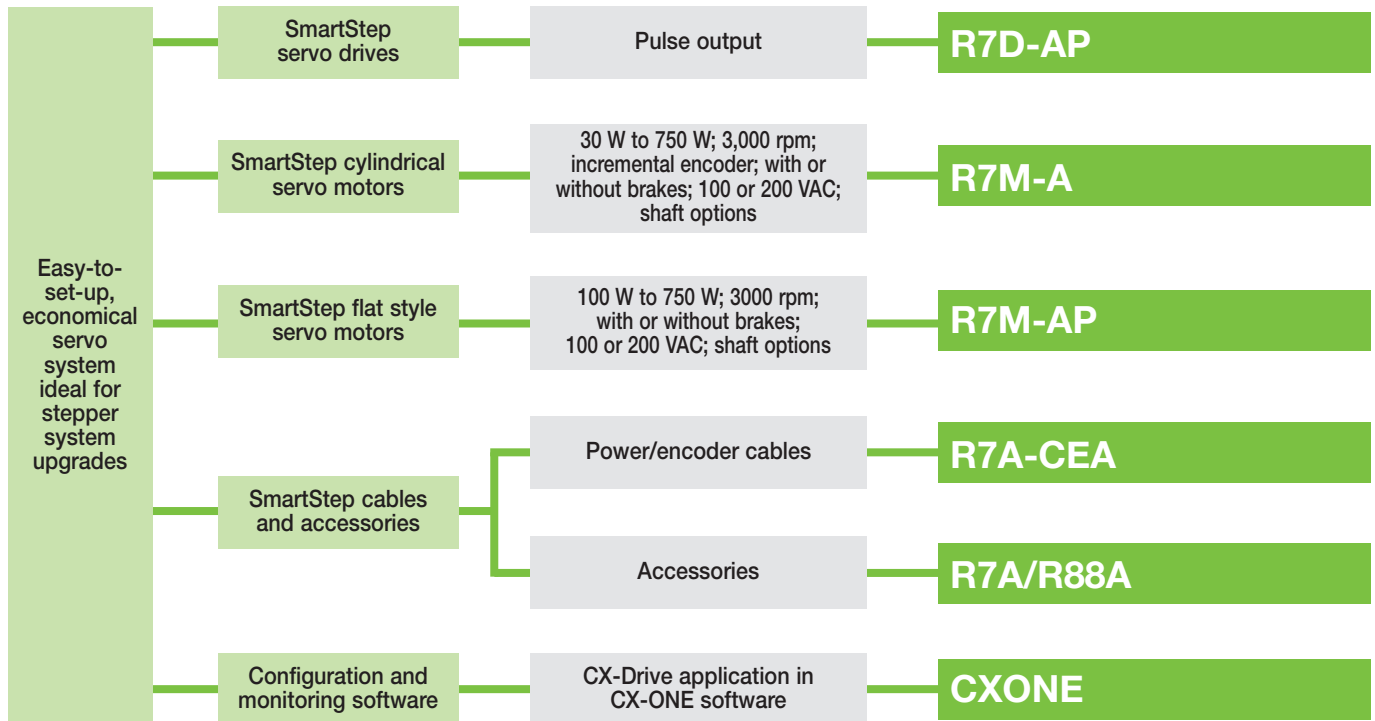

Inverters

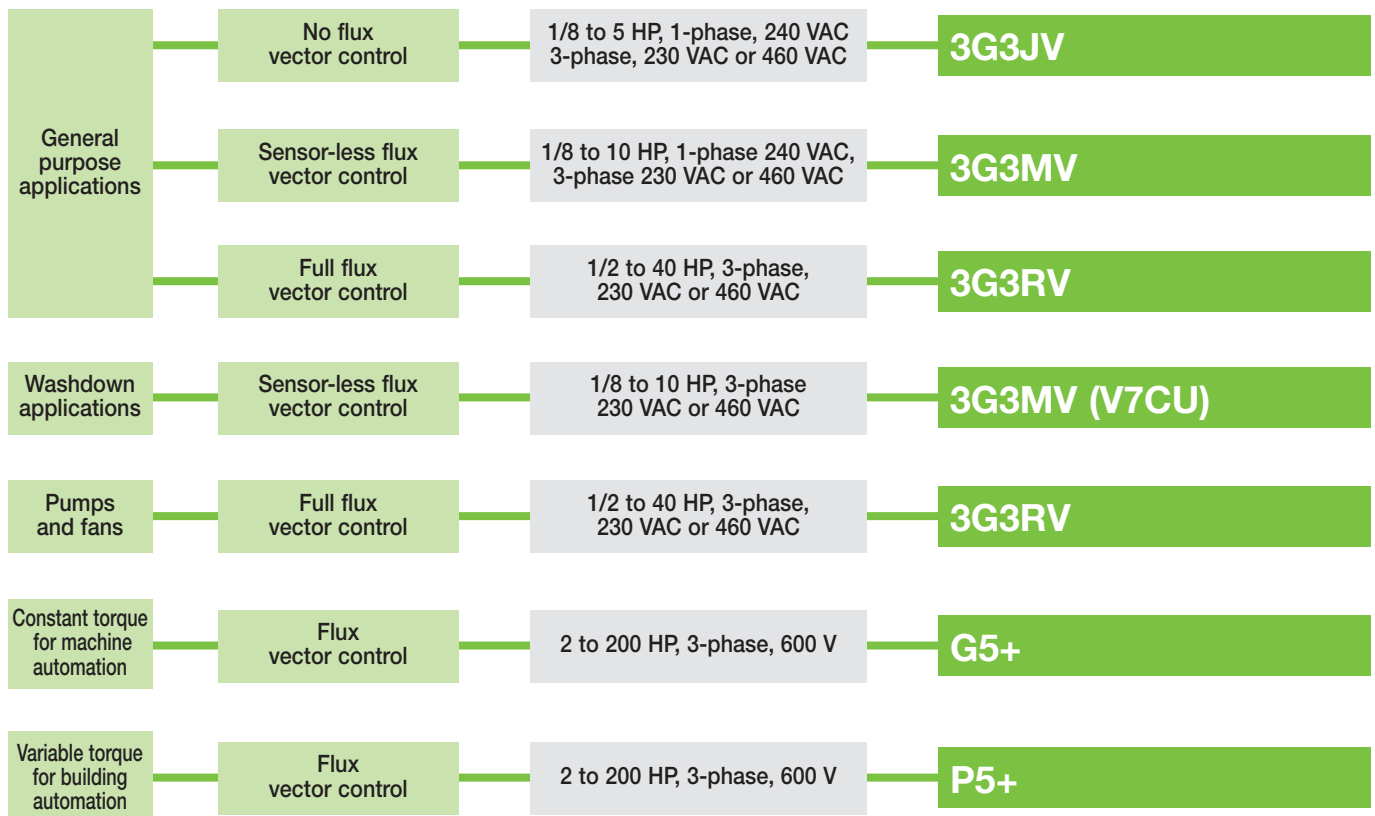

Selection Guide

Inverters

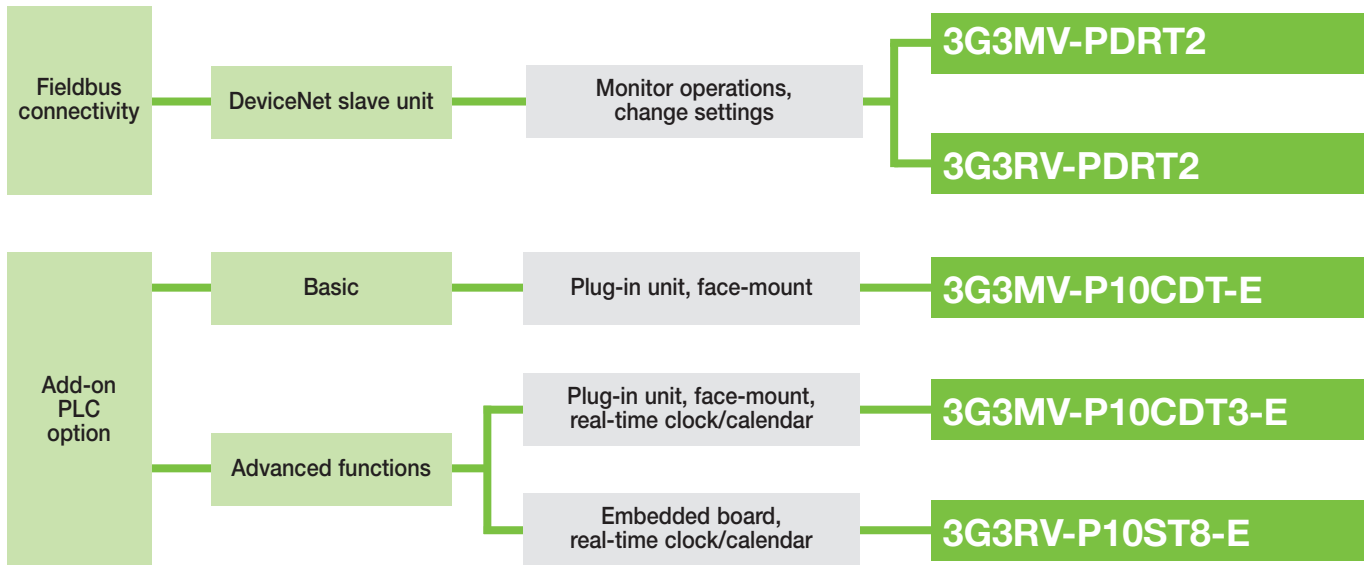

Position Controllers

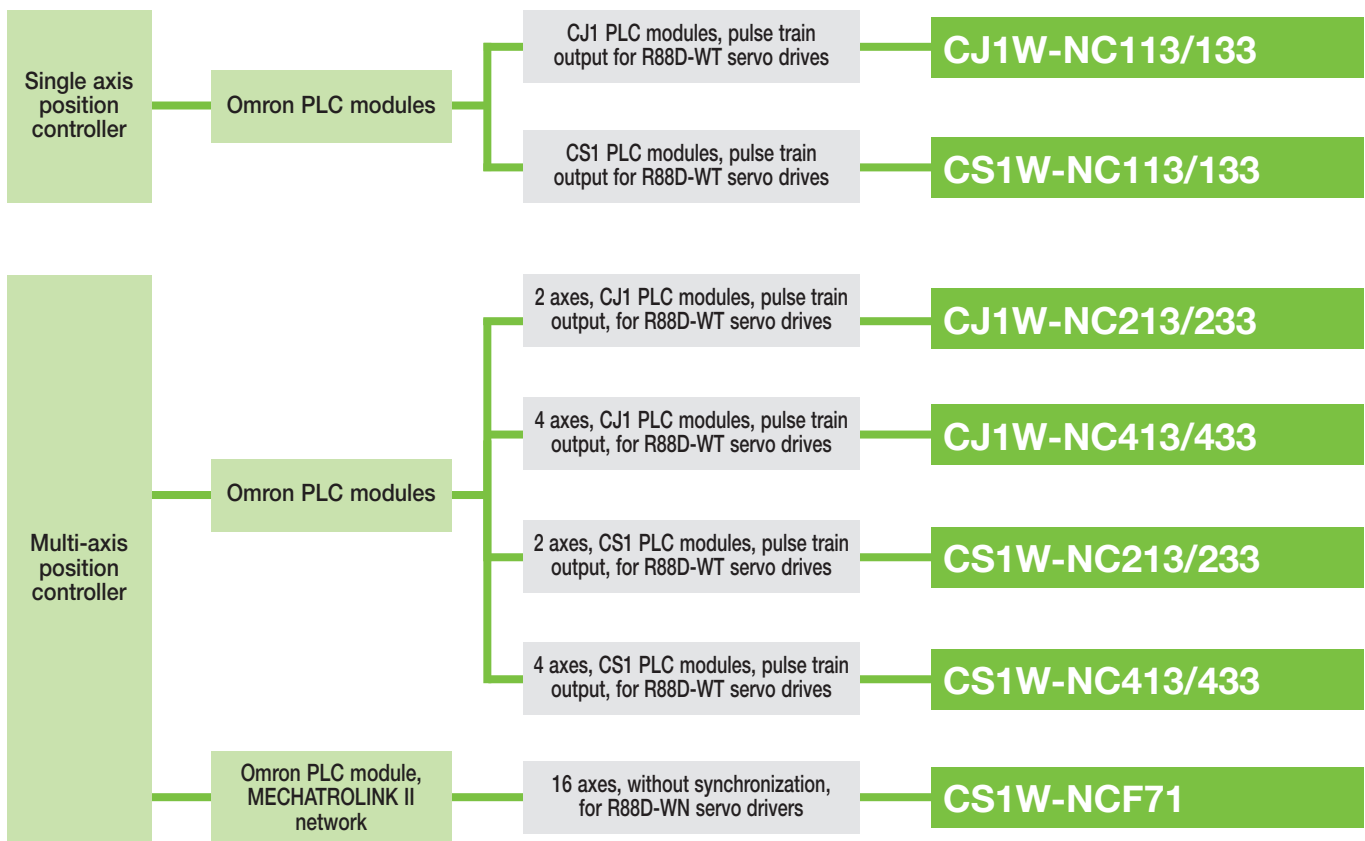

Selection Guide

Motion Controllers

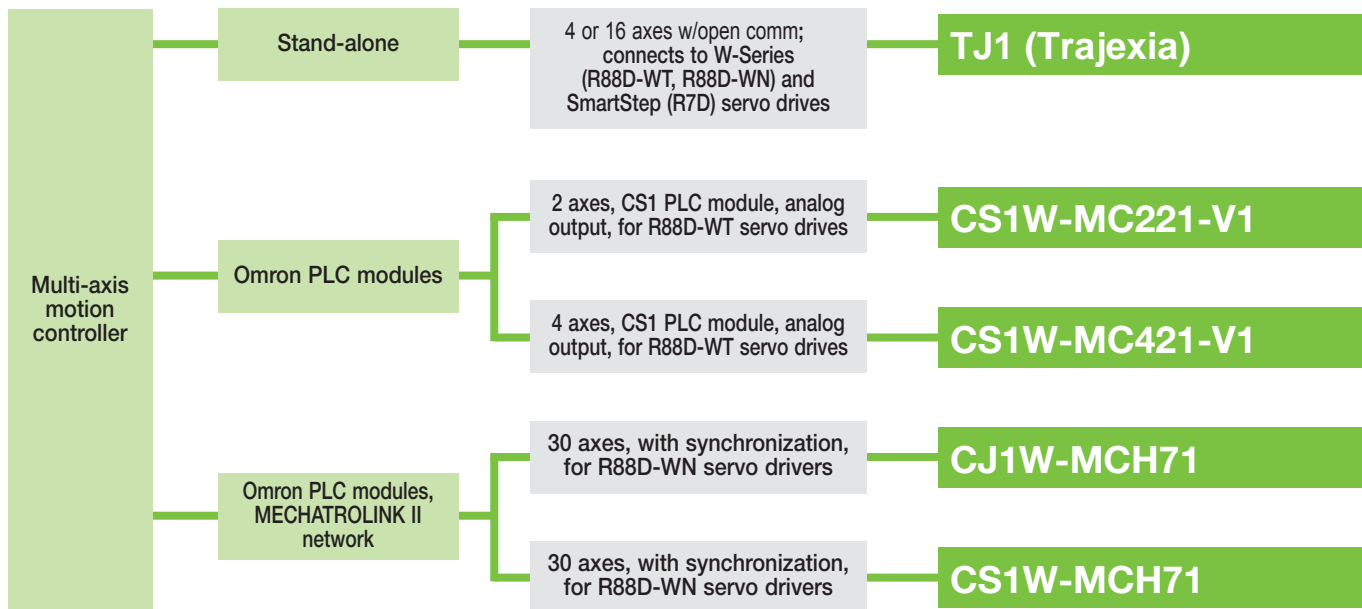

Motion Controllers Used with Servos and Inverters

Type	Controller	Servo	Inverter
Stand-alone	TJ1 (Trajexia)	W-Series: R88D-WT servo drives	3G3MV/3G3RV
PLC module	“-NC” modules or other controller with pulse train	W-Series: R88D-WT servo drives SmartStep: R7D servo drives	—
	“-MC” modules or other controller with analog output	W-Series: R88D-WT servo drives	3G3MV/3G3RV
PLC module with control over MECHATROLINK II	CJ1W-NCF71 module	W-Series: R88D-WN servo drives	—
	“-MCH71” modules	W-Series: R88D-WN servo drives	3G3MV/3G3RV

Selection Guide

High-Speed Counter PLC Modules

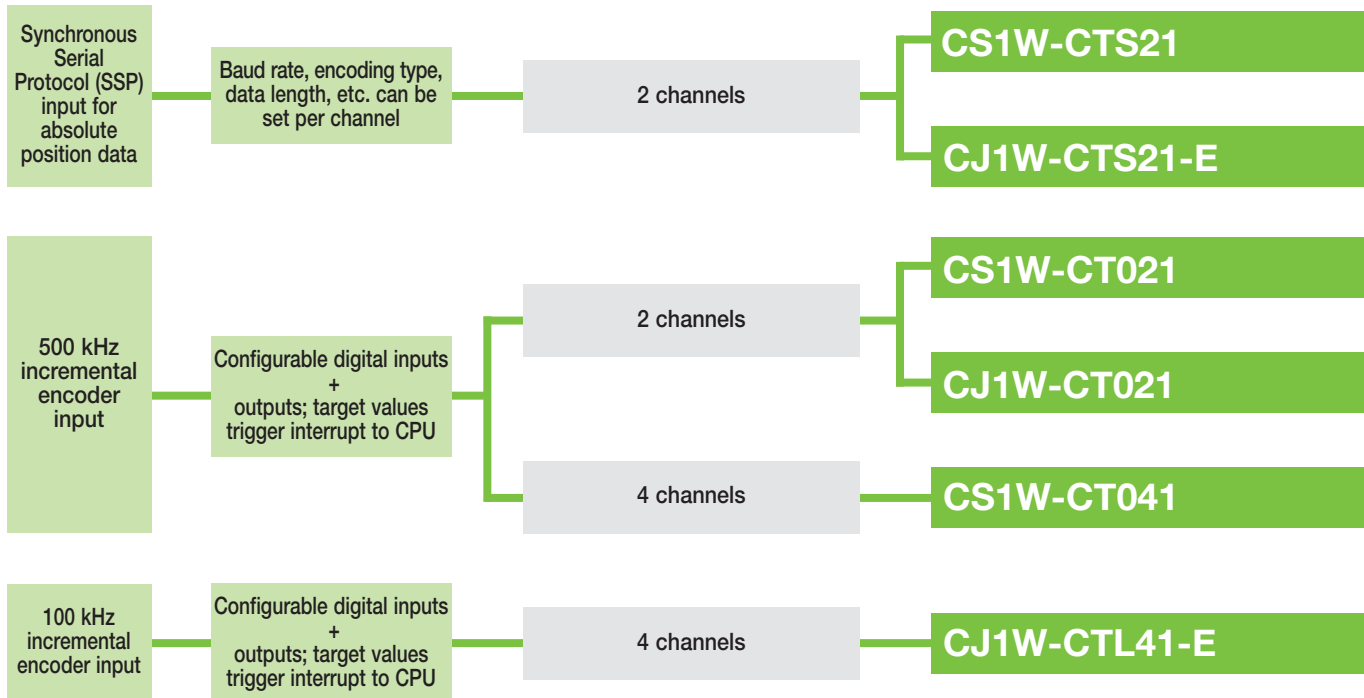

Cam Positioners Emulate Mechanical Cam Switches

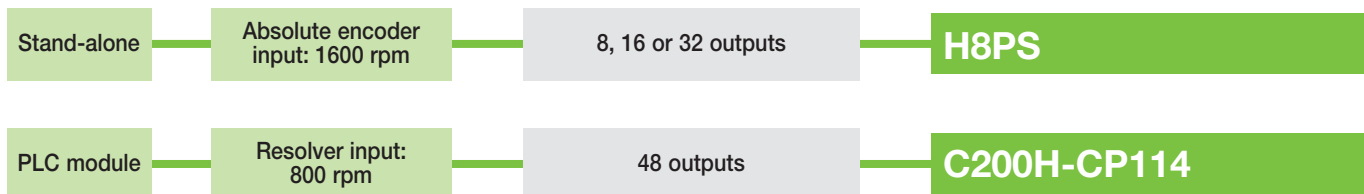

Soft Starters

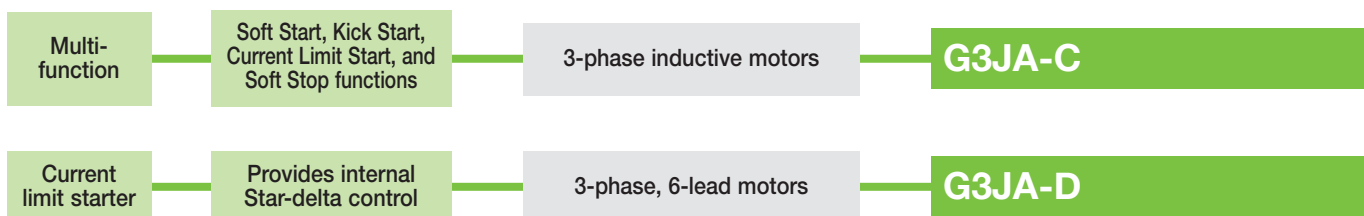

Selection Guide

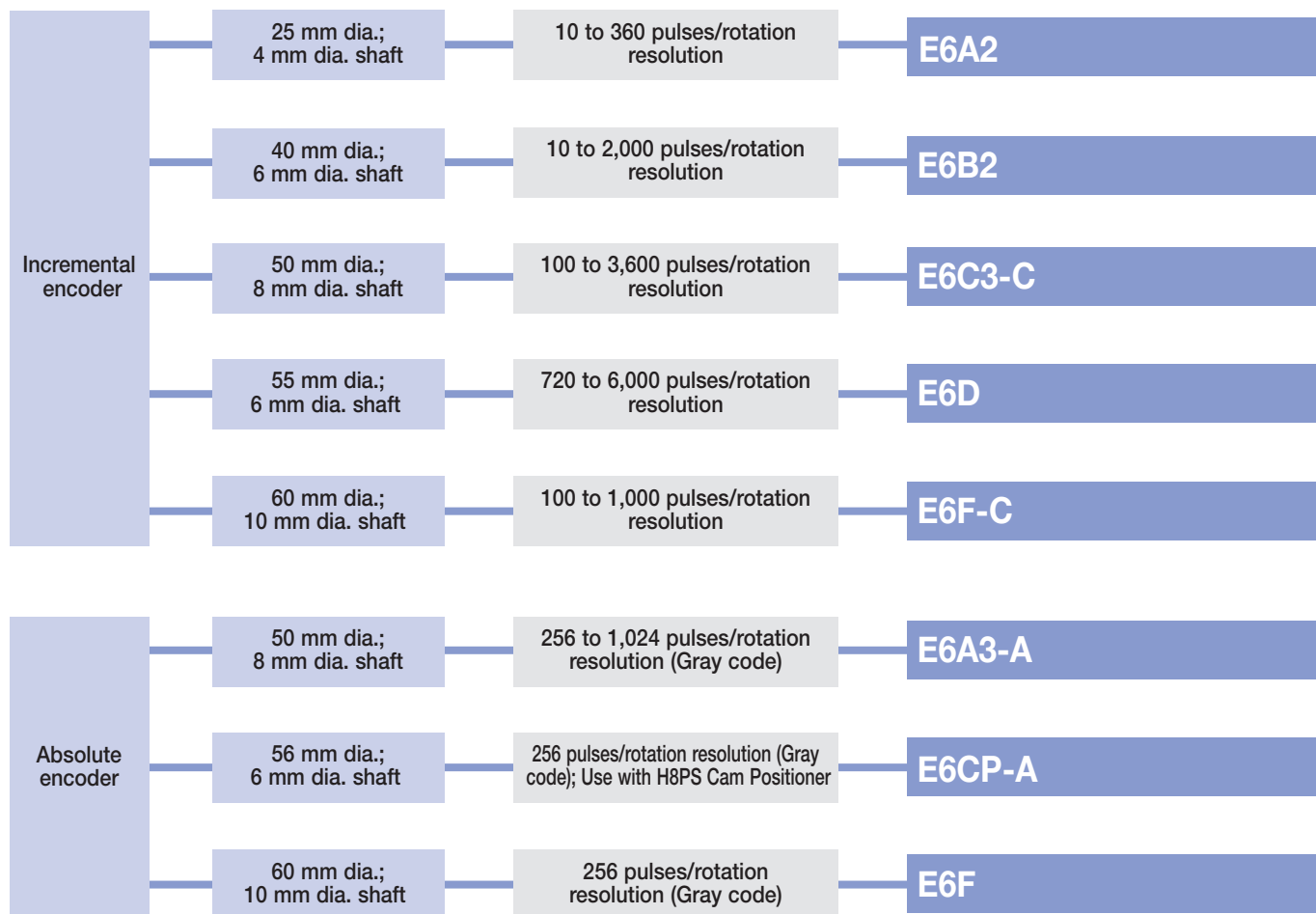

Trajexia Motion Controller TJ1-□



Stand-Alone Advanced Motion Controller Using Mechatrolink-II Motion Bus

- 16 axes advanced motion coordination over a robust and fast motion link MECHATROLINK-II
- Supports position, speed and torque control
- Each axis can run complex interpolation moves, e-cams and e-gearboxes
- Advanced debugging tools including trace and oscilloscope functions
- Hardware registration input for each servo axis
- Control of servos, inverters and I/Os over a single motion network
- Multi-tasking controller capable of running up to 14 tasks simultaneously
- Open communication - Ethernet built-in, PROFIBUS-DP and DeviceNet as options



System Configuration

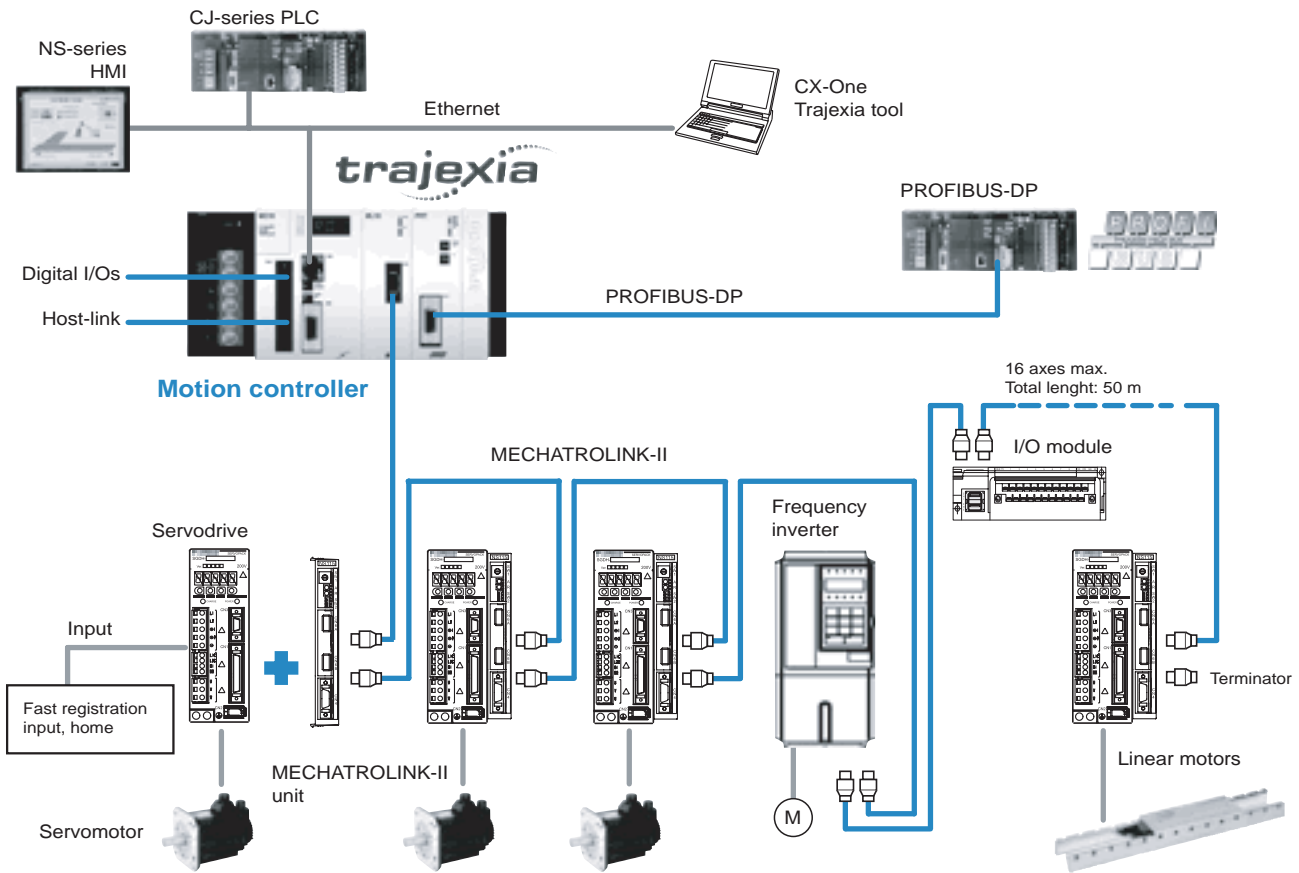

Specifications

General Specifications

Item	Details
Model	TJ1-□
Ambient operating temperature	0 to 55°C
Ambient operating humidity	10 to 90% RH
Ambient storage temperature	-20 to 70°C
Ambient storage humidity	90% max. (with no condensation)
Atmosphere	No corrosive gases
Vibration resistance	10 to 57 Hz: (0.075 mm amplitude) 57 to 100 Hz Acceleration: 9.8 m/s ² , in X, Y and Z directions for 80 minutes
Shock resistance	143 m/s ² , 3 times each X, Y and Z directions
Insulation resistance	20 MOhm
Dielectric strength	500 Volt
Protective structure	IP20
International standards	cULus, CE, EN 61131-2 and RoHS

Motion Control Unit

Item	Details		
Model	TJ1-MC16		
Number of axes	16		
Number of inverters and I/O modules	8 maximum		
Number of Mechatrolink-II master units	Up to 4 Mechatrolink-II master units (TJ1-ML16, see below) can be connected		
Cycle time	Selectable 0.5 ms, 1 ms or 2 ms		
Programming language	BASIC-like Motion language		
Multi-tasking	Up to 14 tasks running simultaneously		
Digital I/O	16 Inputs and 8 Outputs freely configurable		
Measurement units	User definable		
Available memory for user programs	500 kb		
Data storage capacity	Up to 2 MB flash data storage		
Saving program data, motion controller	SRAM with battery backup and Flash-ROM		
Saving program data, personal computer	Trajexia Motion Perfect software manages a backup on the hard disk of the personal computer		
Communication ports	1 Ethernet port and 2 serial ports		
Firmware update	Via Trajexia software tool		
Ethernet port	Electrical characteristics	Conform to IEEE 802.3 (100BaseT)	
	Connector	RJ45 Ethernet connector	
Serial port	Electrical characteristics	Conform 1 port to RS-232C and 1 port to RS-485/RS-422A (selectable by switch)	
	Connector	SUB-D9 connector (Counterpart included in the package)	
	Synchronization	Start-stop synchronization (asynchronous)	
	Baud rate	1200 / 2400 / 4800 / 9600 / 19200 / 38400 bps	
	Transmission format	Databit Length	7 or 8 bit
		Stop bit	1 or 3 bit
		Parity Bit	Even/Odd/None
	Transmission mode	Point-to-multipoint (1:N)	
	Transmission protocol	RS-232C (1:1)	Host Link master protocol, Host Link slave protocol, ASCII general-purpose
		RS-422A (1:N)	Host Link master protocol, Host Link slave protocol, ASCII general-purpose
		RS-485 (1:N)	ASCII general-purpose
Galvanic isolation	RS-422A port		
Communication buffers	254 bytes		
Flow control	None		
Terminator	Yes, selectable by switch		
Cable length	15 m for RS-232 and 500 m for RS-422/RS-485		

Mechatrolink-II Master Unit

Item	Specifications
Model	TJ1-ML16
Controlled devices with Mechatrolink-II interface	Servo drives, various I/O units and Frequency inverters
Electrical characteristics	Conform to MECHATROLINK standard
Communication ports	1 MECHATROLINK-II master
Transmission speed	10 Mbps
Communication cycle	0.5 ms, 1 ms or 2 ms
Stations slave types	Axes or Servo drives Frequency inverters I/O Modules
Number of stations per master / Cycle time	Max. 16 Stations / 2 ms Max. 8 Stations / 1 ms Max. 4 Stations / 0.5 ms
Transmission distance	Max. 50 meters without using repeater

Profibus Slave Unit

Items	Specifications
Model	TJ1-PRT
PROFIBUS standard	Conform to PROFIBUS-DP standard EN50170 (DP-V0)
Communication ports	1 PROFIBUS-DP slave
Transmission speed	9.6, 19.2, 45.45, 93.75, 187.5, 500, 1500, 3000, 6000 and 12000 kbits/s
Node numbers	0 to 99
I/O size	For both directions a configurable size of 0 to 122 words (16-bit)
Galvanic isolation	Yes

DeviceNet Slave Unit

Items	Specifications
Model	TJ1-DRT
DeviceNet standard	Conforms to DeviceNet standard of CIP edition 1
Communication ports	1 DeviceNet slave connector
Transmission speed	125, 250 and 500 Kbps, auto-detected
Node numbers	0 to 63
I/O size	0 to 32 words (16-bit), configurable, for both directions
Galvanic isolation	Yes

Flexible Axis Unit

Items	Specifications	
Model	TJ1-FL02	
Number of axes	2	
Control method	±10 V Analog Output in closed loop or pulse train output in open loop	
Encoder	Position/speed feedback	2 Incremental and Absolute encoders
	Absolute encoder standards supported	SSI, EnDat and Tamagawa
	Encoder Input maximum frequency	6 MHz
	Encoder/Pulse Output max. frequency	2 MHz
Auxiliary I/Os	2 Fast registration inputs, 2 definable inputs, 2 Enable output, 4 position switch outputs or axes reset	
Galvanic isolation	Yes	

Ordering Information

Trajexia Motion Controller

Name	Model
Trajexia Motion Controller Unit, 16 axes (Trajexia end cover unit TJ1-TER is included)	TJ1-MC16
Trajexia Motion Controller Unit, 4 axes (Trajexia end cover unit TJ1-TER is included)	TJ1-MC04
Power Supply for Trajexia system, 100-240V AC	CJ1W-PA202
Power Supply for Trajexia system, 24V DC	CJ1W-PD022

Trajexia — Axes Control Modules

Name	Model
Trajexia MECHATROLINK-II Master Unit (up to 16 axes)	TJ1-ML16
Trajexia MECHATROLINK-II Master Unit (up to 4 axes)	TJ1-ML04
Trajexia Flexible Axis Unit (for 2 axes)	TJ1-FL02

Trajexia — Communication Modules

Name	Model
Trajexia DeviceNet Slave Unit	TJ1-PRT
Trajexia PROFIBUS-DP Slave Unit	TJ1-PRT

Mechatrolink-II — Related Devices

Name	Remarks	Model
Distributed I/O modules	64-point digital input and 64-point digital output (24 VDC)	FNY-IO2310
	Analog input: -10 V to +10 V, 4 channels	FNY-AN2900
	Analog output: -10 V to +10 V, 2 channels	FNY-AN2910
Mechatrolink-II cables	0.5 meter	FNY-W6003-A5
	1 meter	FNY-W6003-01
	3 meters	FNY-W6003-03
	5 meters	FNY-W6003-05
	10 meters	FNY-W6003-10
	20 meters	FNY-W6003-20
	30 meters	FNY-W6003-30
Mechatrolink-II terminator	Terminating resistor	FNY-W6022
Mechatrolink-II interface unit	For W-series Servo drives (Firmware version 39 or later)	FNY-NS115
	For Inverter (For Inverter's version supported contact your Omron sales office)	SI-TV7
	For Inverter (For Inverter's version supported contact your Omron sales office)	SI-T

I/O Cables

Name	Remarks	Length	Model
I/O Cable for FNY-IO2310	With connector on the Distributed I/O module side (FNY-IO2310)	0.5 m	FNY-W5410-05
		1.0 m	FNY-W5410-10
		3.0 m	FNY-W5410-30

Servo System and Inverters

Note: Contact your Omron sales office for detailed specs and ordering information

Software

Specifications	Model
Trajexia Motion Perfect and CX-Drive V1.2 or higher	TJ1-Tools

Servos W-Series

Quick Link
L100

High-Precision Positioning with Advanced Communications

Omron's compact W-Series servos were designed with zero compromise on quality, reliability or performance. The servo amplifiers are ultra-compact with pulse and analog inputs as standard, plus an auto-tuning function. Plug-in option cards offer enhanced functionality such as indexing and complex motions such as cams, gears and linked axes.

MECHATROLINK-II high-speed bus provides instant communications between Omron's W-Series servo drives and PLC-based motion controllers and simplifies coordination of up to 30 axes.

Servo Driver Features

- 300% peak current for 3 seconds
- Automatic motor recognition with auto-tuning function
- Analog and pulse inputs for speed, torque and position control
- MECHATROLINK-II communications bus available built-in (WN-drives) or as an option unit (WT-drives)
- Field bus option units include DeviceNet and Profibus
- Special function option units available for motion controller and indexer
- Trace function allows oscilloscope function for monitoring

Servo Motor Features

- 6 different designs provide a complete range of servo motors to meet the power, speed and performance required for each application
- Peak torque 300% of nominal during 3 seconds
- Slim profile and standard cylindrical motor types
- High resolution incremental encoders standard, absolute encoders available
- Built-in 24V brake available
- Shaft options include straight, with keyway, and with keyway and tap
- IP67 and shaft oil seal available

MECHATROLINK-II is a registered trademark of Yaskawa Corporation.



Servo Motor and Servo Drive Combinations

Servo motors with absolute encoders are available but not shown below.

Servo Motor (R88M-W□□□□□□-□□□)				Servo drive model with MECHATROLINK-II communications (R88D-WN□□□-ML2)			Servo drive model (R88D-WT□□□□)		
Description	Capacity	Model (-W□□□□□□)	Brake and Shaft end options (-□□□)	100 V	200 V, 1-phase	200 V, 3-phase	100 V	200 V, 1-phase	200 V, 2-phase
Cylindrical 3000 rpm, incremental encoder, IP55 (excluding shaft opening)	30 W	03030H	Without brake (blank)	—	—	—	A3HL	A3H	—
	50 W	05030H	With brake (-B)	A5L	A5H	—	A5HL	A5H	—
	100 W	10030H	Straight shaft (blank)	01L	01H	—	01HL	01H	—
	200 W	20030H	Shaft with key (-S1)	02L	02H	—	02HL	02H	—
	400 W	40030H	Shaft with key and tap (-S2)	04L	04H	—	—	04H	—
	750 W	75030H		—	08H	—	—	08H	08H
Cylindrical 3000 rpm, incremental encoder, IP67 (excluding shaft opening)	1 KW	1K030H	Without brake (blank)	—	—	10H	—	—	10H
	1.5 KW	1K530H	With brake (-B)	—	—	15H	—	—	15H
	2 KW	2K030H	Straight shaft (blank)	—	—	20H	—	—	20H
	3 KW	3K030H	Shaft with key and tap (-S2)	—	—	30H	—	—	30H
	4 KW	4K030H		—	—	—	—	—	50H
	5 KW	5K030H		—	—	—	—	—	50H
—	—	—		—	—	—	—	—	
Cylindrical 1500 rpm, incremental encoder, IP67 (excluding shaft opening)	450 W	45015H	Without brake (blank)	—	—	05H	—	—	05H
	850 W	85015H	With brake (-B)	—	—	10H	—	—	10H
	1.3 KW	1K315H	Straight shaft (blank)	—	—	15H	—	—	15H
	1.8 KW	1K815H	Shaft with key and tap (-S2)	—	—	20H	—	—	20H
	2.9 KW	2K915H		—	—	—	—	—	30H
	4.4 KW	4K415H		—	—	—	—	—	50H
	5.5 KW	5K515H		—	—	—	—	—	60H*
	7.5 KW	7K515H		—	—	—	—	—	75H*
	11 KW	11K015H		—	—	—	—	—	150H*
	15 KW	15K015H		—	—	—	—	—	150H*
—	—	—		—	—	—	—	—	
Cylindrical 1000 rpm, incremental encoder, IP67 (excluding shaft opening)	300 W	30010H	Without brake (blank)	—	—	05H	—	—	05H
	600 W	60010H	With brake (-B)	—	—	10H	—	—	08H
	900 W	90010H	Straight shaft (blank)	—	—	10H	—	—	10H
	1.2 KW	1K210H	Shaft with key and tap (-S2)	—	—	15H	—	—	15H
	2 KW	2K010H		—	—	20H	—	—	20H
	3 KW	3K010H		—	—	—	—	—	30H
	4 KW	4K010H		—	—	—	—	—	50H
	5 KW	5K010H		—	—	—	—	—	60H*
—	—	—		—	—	—	—	—	
Flat style, 3000 rpm, incremental encoder, IP55 (excluding shaft opening) or IP67 (including shaft opening)	100 W	P10030H	Without brake (blank)	01L	01H	—	01HL	01H	—
	200 W	P20030H	With brake (-B)	02L	02H	—	02HL	02H	—
	400 W	P40030H	Straight shaft (blank)	04L	04H	—	—	04H	—
	750 W	P75030H	Shaft with key (-S1)	—	08H	—	—	08H	08H
	1.5 KW	P1K530H	Shaft with key and tap (-S2)	—	—	15H	—	—	15H
	—	—		—	—	—	—	—	—

Note: *A regenerative resistor (model R88A-RR8806) must be ordered with these servo drivers.

Ordering Information

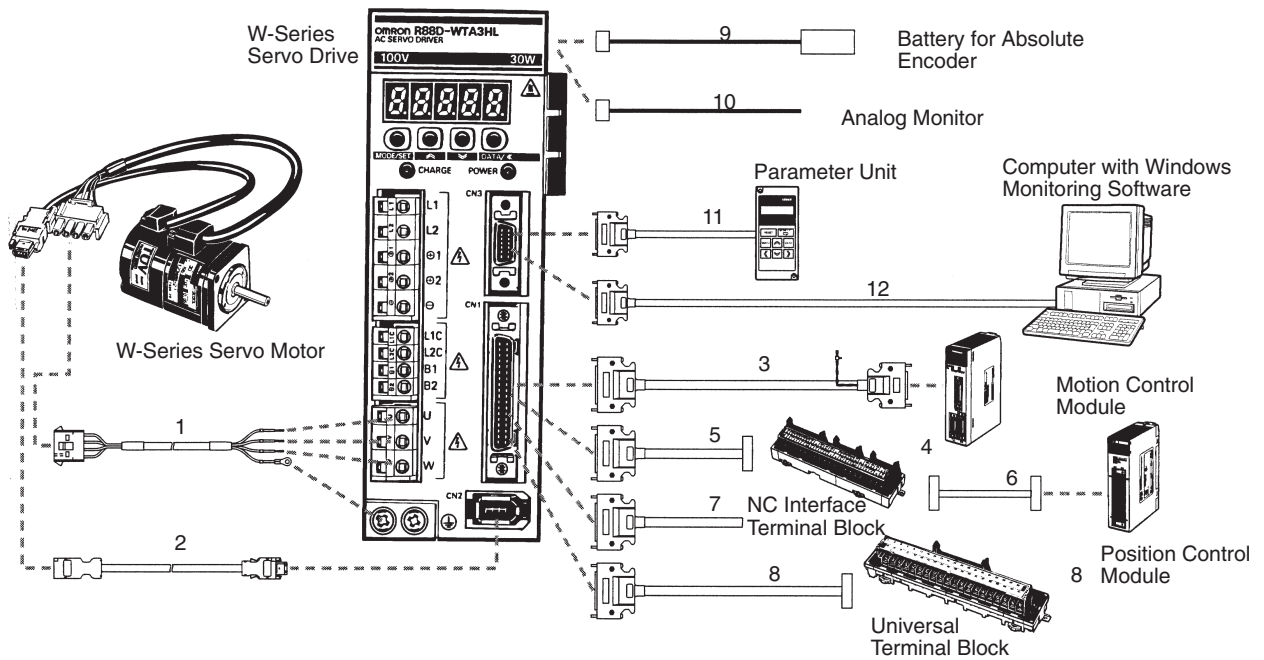

Servo Drives (R88D)

Watts	Voltage	Phase	Model	
			Standard	With MECHATROLINK-II
30	100	1	R88D-WTA3HL	—
50	100	1	R88D-WTA5HL	R88D-WNA5L-ML2
100	100	1	R88D-WT01HL	R88D-WN01L-ML2
200	100	1	R88D-WT02HL	R88D-WN02L-ML2
400	100	1	—	R88D-WN04L-ML2
30	200	1	R88D-WTA3H	—
50	200	1	R88D-WTA5H	R88D-WNA5H-ML2
100	200	1	R88D-WT01H	R88D-WN01H-ML2
200	200	1	R88D-WT02H	R88D-WN02H-ML2
400	200	1	R88D-WT04H	R88D-WN04H-ML2
750	200	1	—	R88D-WN08H-ML2
500	200	3	R88D-WT05H	R88D-WN05H-ML2
750	200	3	R88D-WT08H	—
1000	200	3	R88D-WT10H	R88D-WN10H-ML2
1500	200	3	R88D-WT15H	R88D-WN15H-ML2
2000	200	3	R88D-WT20H	R88D-WN20H-ML2
3000	200	3	R88D-WT30H	R88D-WN30H-ML2
4000	200	3	R88D-WT50H	—
5000	200	3	R88D-WT50H	—
5500	200	3	R88D-WT60H	—
7500	200	3	R88D-WT75H	—
15,000	200	3	R88D-WT150H	—

Cylindrical Style Servo Motors

R88M-W□□□ □□ □- □ □ □□
4 5 6 7 8 9

Build a part number as follows:

R88M-W75030T-BS2 = 750 W, 3000 RPM, 200 VAC motor with absolute encoder, brakes, and shaft with key and tap

4	5	Basic model	6				7		8			9			
Capacity	Rotation speed	Cylindrical style	Motor power supply and encoder type H = 200 VAC, incremental L = 100 VAC, incremental T = 200 VAC, absolute S = 100 VAC absolute				With/without brakes		Oil seal options Blank = none O = oil seal			Shaft shape Blank: straight S1 = with key S2 = with key and tap S3 = straight with tap			
W	RPM	R88M-W	H	L	T	S	Blank	B	Blank	O	W	Blank	S1	S2	S3
30	3,000	R88M-W03030	Yes	Yes	Yes	Yes	Yes	Yes	Yes	Yes	—	Yes	Yes	Yes	Yes
50		R88M-W05030	Yes	Yes	Yes	Yes	Yes	Yes	Yes	Yes	—	Yes	Yes	Yes	Yes
100		R88M-W10030	Yes	Yes	Yes	Yes	Yes	Yes	Yes	Yes	—	Yes	Yes	Yes	Yes
200		R88M-W20030	Yes	Yes	Yes	Yes	Yes	Yes	Yes	Yes	—	Yes	Yes	Yes	Yes
400		R88M-W40030	Yes	—	Yes	—	Yes	Yes	Yes	Yes	—	Yes	Yes	Yes	Yes
750		R88M-W75030	Yes	—	Yes	—	Yes	Yes	Yes	Yes	—	Yes	Yes	Yes	Yes
1 kW		R88M-W1K030	Yes	—	Yes	—	Yes	Yes	Yes	Yes	—	Yes	—	Yes	—
1.5 kW		R88M-W1K530	Yes	—	Yes	—	Yes	Yes	Yes	Yes	—	Yes	—	Yes	—
2 kW		R88M-W2K030	Yes	—	Yes	—	Yes	Yes	Yes	Yes	—	Yes	—	Yes	—
3 kW		R88M-W3K030	Yes	—	Yes	—	Yes	Yes	Yes	Yes	—	Yes	—	Yes	—
4 kW	R88M-W4K030	Yes	—	Yes	—	Yes	Yes	Yes	Yes	—	Yes	—	Yes	—	
5 kW	R88M-W5K030	Yes	—	Yes	—	Yes	Yes	Yes	Yes	—	Yes	—	Yes	—	
450	1,500	R88M-W45015	—	—	Yes	—	Yes	Yes	Yes	Yes	—	Yes	—	Yes	—
850		R88M-W85015	—	—	Yes	—	Yes	Yes	Yes	Yes	—	Yes	—	Yes	—
1.3 kW		R88M-W1K315	—	—	Yes	—	Yes	Yes	Yes	Yes	—	Yes	—	Yes	—
1.8 kW		R88M-W1K815	—	—	Yes	—	Yes	Yes	Yes	Yes	—	Yes	—	Yes	—
2.9 kW		R88M-W2K915	—	—	Yes	—	Yes	Yes	Yes	Yes	—	Yes	—	Yes	—
4.4 kW		R88M-W4K415	—	—	Yes	—	Yes	Yes	Yes	Yes	—	Yes	—	Yes	—
5.5 kW		R88M-W5K515	—	—	Yes	—	Yes	Yes	Yes	Yes	—	Yes	—	Yes	—
7.5 kW		R88M-W7K515	—	—	Yes	—	Yes	Yes	Yes	Yes	—	Yes	—	Yes	—
11 kW		R88M-W11K015	—	—	Yes	—	Yes	Yes	Yes	Yes	—	Yes	—	Yes	—
15 kW		R88M-W15K015	—	—	Yes	—	Yes	Yes	Yes	Yes	—	Yes	—	Yes	—
300	1,000	R88M-W30010	Yes	—	Yes	—	Yes	Yes	Yes	Yes	—	Yes	—	Yes	—
600		R88M-W60010	Yes	—	Yes	—	Yes	Yes	Yes	Yes	—	Yes	—	Yes	—
900		R88M-W90010	Yes	—	Yes	—	Yes	Yes	Yes	Yes	—	Yes	—	Yes	—
1.2 kW		R88M-W1K210	Yes	—	Yes	—	Yes	Yes	Yes	Yes	—	Yes	—	Yes	—
2 kW		R88M-W2K010	Yes	—	Yes	—	Yes	Yes	Yes	Yes	—	Yes	—	Yes	—
3 kW		R88M-W3K010	Yes	—	Yes	—	Yes	Yes	Yes	Yes	—	Yes	—	Yes	—
4 kW		R88M-W4K010	Yes	—	Yes	—	Yes	Yes	Yes	Yes	—	Yes	—	Yes	—
5.5 kW		R88M-W5K510	Yes	—	Yes	—	Yes	Yes	Yes	Yes	—	Yes	—	Yes	—

Flat Style Servo Motors

R88M-WP□□□ □□ □- □ □ □□
4 5 6 7 8 9

Build a part number as follows:

R88M-WP20030H-BWS1 = 200 W, 3000 RPM, 200 VAC motor with absolute encoder, brakes, waterproof seal (IP67), and shaft with key

4	5	Basic model	6				7		8			9			
Capacity	Rotation speed	Flat style	Motor power supply and encoder type H = 200 VAC, incremental L = 100 VAC, incremental T = 200 VAC, absolute S = 100 VAC absolute				With/without brakes		Waterproof (IP67) /oil seal options Blank = none O = oil seal W = waterproof			Shaft shape Blank: straight S1 = with key S2 = with key and tap S3 = straight with tap			
W	RPM	R88M-WP	H	L	T	S	Blank	B	Blank	O	W	Blank	S1	S2	S3
100 W	3,000	R88M-WP10030	Yes	Yes	Yes	Yes	Yes	Yes	Yes	Yes	Yes	Yes	Yes	Yes	Yes
200 W		R88M-WP20030	Yes	Yes	Yes	Yes	Yes	Yes	Yes	Yes	Yes	Yes	Yes	Yes	Yes
400 W		R88M-WP40030	Yes	—	Yes	—	Yes	Yes	Yes	Yes	Yes	Yes	Yes	Yes	Yes
750 W		R88M-WP75030	Yes	—	Yes	—	Yes	Yes	Yes	Yes	Yes	Yes	Yes	Yes	Yes
1.5 kW		R88M-WP1K530	Yes	—	Yes	—	Yes	Yes	Yes	Yes	Yes	Yes	Yes	Yes	Yes

Note: Circled numbers refer to the configuration diagram on page I-3.

① Servo Motor Power Cables

Applicable servo motors	Length	Model	
		For motors without brakes	For motors with brakes
30-W to 750-W Cylindrical style motors (3,000 RPM) 100-W to 750-W Flat style motors (3,000 RPM)	3 m	R88A-CAWA003S	R88A-CAWA003B
	5 m	R88A-CAWA005S	R88A-CAWA005B
	10 m	R88A-CAWA010S	R88A-CAWA010B
	15 m	R88A-CAWA015S	R88A-CAWA015B
	20 m	R88A-CAWA020S	R88A-CAWA020B
	30 m	R88A-CAWA030S	R88A-CAWA030B
	40 m	R88A-CAWA040S	R88A-CAWA040B
	50 m	R88A-CAWA050S	R88A-CAWA050B
1.5-kW Flat style motors	3 m	R88A-CAWB003S	R88A-CAWB003B
	5 m	R88A-CAWB005S	R88A-CAWB005B
	10 m	R88A-CAWB010S	R88A-CAWB010B
	15 m	R88A-CAWB015S	R88A-CAWB015B
	20 m	R88A-CAWB020S	R88A-CAWB020B
	30 m	R88A-CAWB030S	R88A-CAWB030B
	40 m	R88A-CAWB040S	R88A-CAWB040B
	50 m	R88A-CAWB050S	R88A-CAWB050B
300-W to 900-W Cylindrical style motors (1,000 RPM) 1-kW to 2-kW Cylindrical style motors (3,000 RPM)	3 m	R88A-CAWC003S	R88A-CAWC003B
	5 m	R88A-CAWC005S	R88A-CAWC005B
	10 m	R88A-CAWC010S	R88A-CAWC010B
	15 m	R88A-CAWC015S	R88A-CAWC015B
	20 m	R88A-CAWC020S	R88A-CAWC020B
	30 m	R88A-CAWC030S	R88A-CAWC030B
	40 m	R88A-CAWC040S	R88A-CAWC040B
	50 m	R88A-CAWC050S	R88A-CAWC050B
1.2-kW to 3-kW Cylindrical style servo motors (1,000 RPM) 3-kW to 5-kW Cylindrical style servo motors (3,000 RPM) 1.8 kW to 4.4 kW Cylindrical style servo motors (1,500 RPM)	3 m	R88A-CAWD003S	R88A-CAWD003B
	5 m	R88A-CAWD005S	R88A-CAWD005B
	10 m	R88A-CAWD010S	R88A-CAWD010B
	15 m	R88A-CAWD015S	R88A-CAWD015B
	20 m	R88A-CAWD020S	R88A-CAWD020B
	30 m	R88A-CAWD030S	R88A-CAWD030B
	40 m	R88A-CAWD040S	R88A-CAWD040B
	50 m	R88A-CAWD050S	R88A-CAWD050B
5.5 kW Cylindrical style servo motors (1,500 RPM) 4 kW Cylindrical style servo motors (1,000 RPM)	3 m	R88A-CAWE003S	R88A-CAWE003B §
	5 m	R88A-CAWE005S	R88A-CAWE005B §
	10 m	R88A-CAWE010S	R88A-CAWE010B §
	15 m	R88A-CAWE015S	R88A-CAWE015B §
	20 m	R88A-CAWE020S	R88A-CAWE020B §
	30 m	R88A-CAWE030S	R88A-CAWE030B §
	40 m	R88A-CAWE040S	R88A-CAWE040B §
	50 m	R88A-CAWE050S	R88A-CAWE050B §
7.5 to 11 kW Cylindrical style servo motors (1,500 RPM) 5.5 kW Cylindrical style servo motors (1,000RPM)	3 m	R88A-CAWF003S	R88A-CAWF003B §
	5 m	R88A-CAWF005S	R88A-CAWF005B §
	10 m	R88A-CAWF010S	R88A-CAWF010B §
	15 m	R88A-CAWF015S	R88A-CAWF015B §
	20 m	R88A-CAWF020S	R88A-CAWF020B §
	30 m	R88A-CAWF030S	R88A-CAWF030B §
	40 m	R88A-CAWF040S	R88A-CAWF040B §
	50 m	R88A-CAWF050S	R88A-CAWF050B §

§ For these motors with brake, a cable for power is required in addition to the brake cable. (Example, for servo motor model R88M-W5K515T-BS2, order both R88A-CAWE015S power cable and R88A-CAWE015B brake cable.)

Note: For 15kW Cylindrical style servomotors (1,500 RPM) use cable AWG4 x 4C UL62, with max. length 50 m and connectors plug MS3108B32-17S with cable plug MS3102A32-17P.

② Encoder Cables

Applicable servo motors	Length	Model
30-W to 750-W Cylindrical-style motors (3,000 RPM) 100-W to 1.5-kW Flat style Motors (3,000 RPM)	3 m	R88A-CRWA003C
	5 m	R88A-CRWA005C
	10 m	R88A-CRWA010C
	15 m	R88A-CRWA015C
	20 m	R88A-CRWA020C
	30 m	R88A-CRWA030C
	40 m	R88A-CRWA040C
	50 m	R88A-CRWA050C
1-kW to 5-kW Cylindrical-style motors (3,000 RPM) 300-W to 5.5-kW Cylindrical-style motors (1,000 RPM) 450-W to 15.0-kW Cylindrical-style motors (1,500 RPM)	3 m	R88A-CRWB003N
	5 m	R88A-CRWB005N
	10 m	R88A-CRWB010N
	15 m	R88A-CRWB015N
	20 m	R88A-CRWB020N
	30 m	R88A-CRWB030N
	40 m	R88A-CRWB040N
	50 m	R88A-CRWB050N

Cables and Accessories

Application	Description	Length	Model
③ Cables for Motion Control modules	Control cables for 1 axis (common to CS1, C200H, and CV-Series Controllers)	1 m	R88A-CPW001M1
		2 m	R88A-CPW002M1
		3 m	R88A-CPW003M1
		5 m	R88A-CPW005M1
	Control cables for 2 axes (common to SYSMAC CS1, C200H, and CV-Series controllers)	1 m	R88A-CPW001M2
		2 m	R88A-CPW002M2
		3 m	R88A-CPW003M2
		5 m	R88A-CPW005M2
④ Servo relay units connect cables from PLC position controller and servo drive	1-axis Position Control Unit (CS1W-NC113/133, CJ1W-NC113/133); does not support communications functions	—	XW2B-20J6-1B
	2-axis Position Control Unit (CS1W-NC213/233/413/433, CJ1W-NC213/233/413/433); does not support communications functions	—	XW2B-40J6-2B
	1-axis CQM1H-PLB21 and CQM1-CPU43-V1; does not support communications functions	—	XW2B-20J6-3B
	1-axis CJ1M-CPU22/23; does not support communications functions	—	XW2B-20J6-8A
	2-axis CJ1M-CPU22/23; does not support communications functions	—	XW2B-40J6-9A
⑤ Servo drive connecting cable	Connects Servo Relay Units XW2B-20J6-1B, XW2B-40J6-2B, XW2B-20J6-3B, XW2B-20J6-8A, or XW2B-40J6-9A	1 m	XW2Z-100J-B4
		2 m	XW2Z-200J-B4
	Connects Servo Relay Unit XW2B-40J6-4A	1 m	XW2Z-100J-B8
		2 m	XW2Z-200J-B8
⑥ Position controller PLC module cable	CQM1H-PLB21 and CQM1-CPU43-V1 to XW2B-20J6-3B servo relay unit	1 m	XW2Z-100J-A3
	CJ1W-NC113 to XW2B-20J6-1B servo relay unit	1 m	XW2Z-100J-A16
	CJ1W-NC213 or CJ1W-NC413 to XW2B-20J6-2B servo relay unit	1 m	XW2Z-100J-A17
	CJ1W-NC133 to XW2B-20J6-1B servo relay unit	1 m	XW2Z-100J-A20
	CJ1W-NC233 or CJ1W-NC433 to XW2B-40J6-2B servo relay unit	1 m	XW2Z-100J-A21
	CJ1M-CPU22 or CJ1M-CPU23 to XW2B-20J6-8A (1 axis) or XW2B-40J6-9A (2 axes) servo relay unit	1 m	XW2Z-100J-A26
	CS1W-NC113 to XW2B-20J6-1B servo relay unit	1 m	XW2Z-100J-A8
	CS1W-NC213 or CS1W-NC413 to XW2B-40J6-2B servo relay unit	1 m	XW2Z-100J-A9
	CS1W-NC133 to XW2B-20J6-B1 servo relay unit	1 m	XW2Z-100J-A12
CS1W-NC233 or CS1W-NC433 to XW2B-40J6-2B servo relay unit	1 m	XW2Z-100J-A13	
⑦ General purpose controller cables	Control cables with connector at one end	1 m	R88A-CPW001S
		2 m	R88A-CPW002S

Cables and Accessories (Continued)

Application	Description	Length	Model
⑧ Universal terminal block cable	Cables for universal terminal block XW2B-50G5	1 m	R88A-CTW001N
		2 m	R88A-CTW002N
	Control I/O connector; fits port CN1 (WT-series only)	—	R88A-CNU11C
	Control I/O connector; fits port CN1 (WN-series only)	—	R88A-CNW01C
	Universal terminal block	—	XW2B-50G5
	Cable from relay terminal block XW2B-20G4/XW2B-20G5/XW2D-20G6 to WN-series servo drive CN1	1 m	XW2Z-100J-B16
		2 m	XW2Z-200J-B16
	Cable from relay terminal block XW2B-20G4/XW2B-20G5/XW2D-20G6 to WT-series servo drive CN1	1 m	XW2Z-100J-B15
	2 m	XW2Z-200J-B15	
⑨ Battery backup	Servo drives R88D-WT50H or less	—	R88A-BAT01W
	Servo drives R88D-WT60H/75H/150H	—	R88A-BAT02W
	Servo drives R88D-WN, all models (connected in series with encoder cables in ②)	0.3 m	R88A-CRWC0R3C
⑩ Analog monitor cable	Peripheral cable for analog monitoring; servo drive to PC; connects to port CN4	1 m	R88A-CMW001S
⑪ Parameter unit	Panel mount unit sets and displays servo drive parameters; includes cable	1 m	R88A-PR02W
⑫ Personal computer cable	Connects a personal computer for monitoring; servo drive to PC; connects to port CN3	2 m	R88A-CCW002P2

External Regenerative Resistors

Rating	Model
220 W 47 Ω	R88A-RR22047S
880 W 6.25 Ω	R88A-RR88006*

* Resistor required for use with Servo Driver models R88D-WT60H/WT75H/WT150H.

DC Reactors

Applicable servo drive	Model
For R88D-WT30H	R88A-PX5059
For R88D-WT15H/WT20H	R88A-PX5060
For R88D-WT05H/WT08H/WT10H	R88A-PX5061
For R88D-WT02HL	R88A-PX5062
For R88D-WTA3HL/WTA5HL/WT01HL	R88A-PX5063
For R88D-WT50H	R88A-PX5068
For R88D-WT04H	R88A-PX5069
For R88D-WT02H	R88A-PX5070
For R88D-WTA3H/WTA5H/WT01H	R88A-PX5071

AC Reactors

Applicable servo drive	Model
For R88D-WTA3HL to WT01HL/WD30H to WD02H	R88A-F1W104-E
For R88D-WT02HL/WT04H	R88A-F1W107-E
For R88D-WT05H/WT08H	R88A-F1W115-E
For R88D-WT10H	R88A-F1W125-E
For R88D-WT15H/WT20H	LF-315K
For R88D-WT30H	LF-325K
For R88D-WT50H	LF-335K
For R88D-WT60H	LF-380K

Network Communication Adapters

DeviceNet Option Unit mounts to a W-Series AC Servo drives and performs both DeviceNet communications functions and Position Control Unit functions. Parameters can be set, the operating status can be monitored, and faults can be predicted from a PLC up to 500 m away.

- **Trace Function:** When trigger conditions are satisfied, up to two analog elements and two ON/OFF elements can be recorded in the DeviceNet Option Unit and read from the PLC.
- **Monitor Item Reading Function:** The contents of AC Servo drive monitor display can be read from the PLC.
- **Batch Handling of Operating Information** for Servo Systems Information that can be displayed at W-series AC Servo Drivers using monitor functions (e.g., speed commands and speed feedback) can be read by a PLC using remote I/O functions.

Description	Model
DeviceNet Option Unit	R88A-NCW152-DRT
External I/O Connector	R88A-CNU01R
Cable for Setup Tool (IBM PC/AT or compatible; 2 m length)	R88A-CCW002P4

MECHATROLINK-II Interface Unit for WT-Series Drives

Description	Cable length	Model
MECHATROLINK-II Interface Unit	—	FNY-NS115
MECHATROLINK-II cable	0.5 m	FNY-W6003-A5
	1 m	FNY-W6003-01
	3 m	FNY-W6003-03
	5 m	FNY-W6003-05
	10 m	FNY-W6003-10
	20 m	FNY-W6003-20
	30 m	FNY-W6003-30
MECHATROLINK-II terminating resistor	—	FNY-W6022

Servos SmartStep

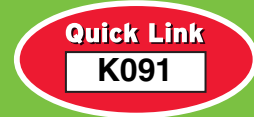

Cost-Effective Servo Capability with Stepper Simplicity

Easily migrate from steppers to the higher precision of servos in minutes with Omron's SmartStep servo drivers and ultra-compact 3-phase servo motors. They accept pulse-train input that can be configured quickly via simple DIP switches and have an on-line auto-tuning function. SmartStep offers all the simplicity and cost-effectiveness of a stepper with the added advantages of the servo drive capability.



Motor Features

- Sizes 30 W to 750 W, rated speed 3,000 rpm
- Accepts incremental encoder input at 2,000 p/r
- Cylindrical and flat type servo motors available
- Peak torque up to three times continuous torque during 3 seconds
- Easy to install with pre-built cables
- Motors with brake are available

Driver Features

- Output range from 30 W to 750 W
- 300% peak current over nominal
- Control via pulse train (speed and position)

- Four position resolution settings:
 - 500 pulses/rotation (0.72°/step)
 - 1,000 pulses/rotation (0.36°/step)
 - 5,000 pulses/rotation (0.072°/step)
 - 10,000 pulses/rotation (0.036°/step)
- SmartStep does not require the use of PC configuration software, making setup as easy as using a stepper motor for basic capabilities
- To optimize performance, use PC software for on-line auto-tuning of values and monitoring

Ordering Information

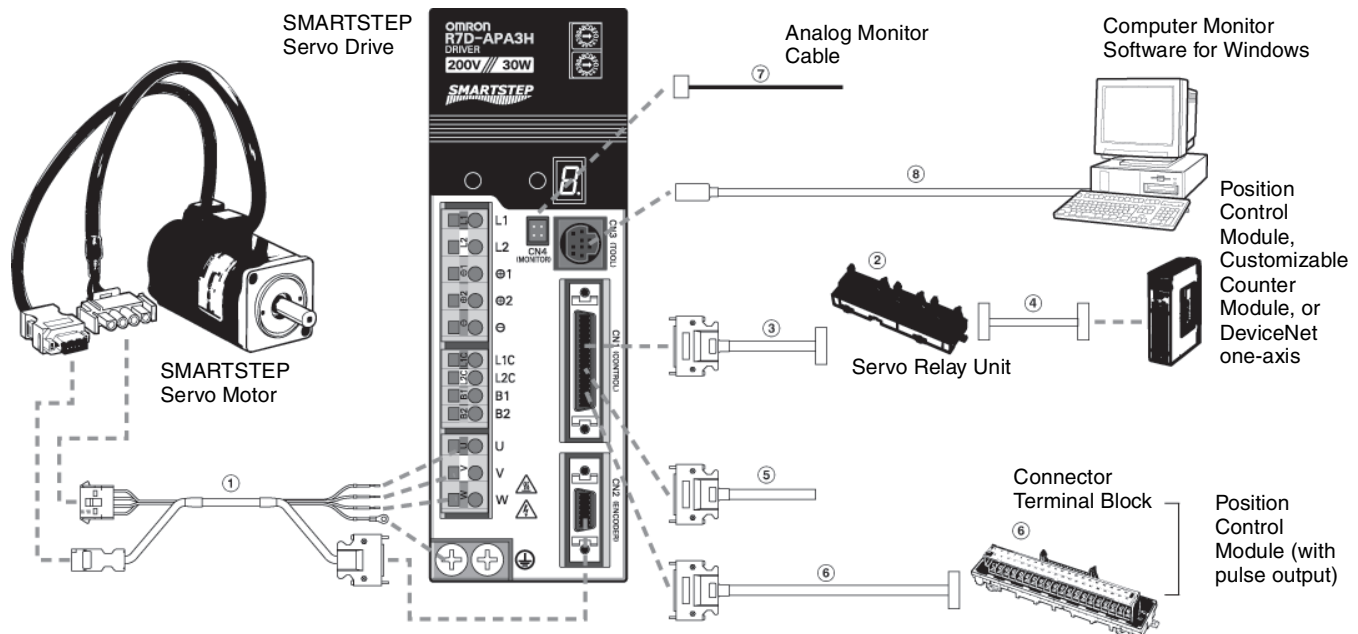

Add cable length to the part number in place of □□□: 003 for 3 m cable, 005 for 5 m, 010 for 10 m, 015 for 15 m and 020 for 20 m.

Note: Circled numbers refer to the configuration diagram on page I-8.

SmartStep Servos

Wattage	Servo motor model	Servo drive model	① Power cable/Encoder cable model (Add cable length for □□□)
Cylindrical Servo Motors 100 VAC Without Brake, Shaft Without Keyway			
30 W	R7M-A03030-S1	R7D-APA3L	R7A-CEA□□□S
50 W	R7M-A05030-S1	R7D-APA5L	R7A-CEA□□□S
100 W	R7M-A10030-S1	R7D-AP01L	R7A-CEA□□□S
200 W	R7M-A20030-S1	R7D-AP02L	R7A-CEA□□□S
400 W	R7M-A40030-S1	R7D-AP04L	R7A-CEA□□□S
Cylindrical Servo Motors 100 VAC With Brake, Shaft With Keyway			
30 W	R7M-A03030-BS1	R7D-APA3L	R7A-CEA□□□B
50 W	R7M-A05030-BS1	R7D-APA5L	R7A-CEA□□□B
100 W	R7M-A10030-BS1	R7D-AP01L	R7A-CEA□□□B
200 W	R7M-A20030-BS1	R7D-AP02L	R7A-CEA□□□B
400 W	R7M-A40030-BS1	R7D-AP04L	R7A-CEA□□□B
Cylindrical Servo Motors 200 VAC Without Brake, Shaft With Keyway			
30 W	R7M-A03030-S1	R7D-APA3H	R7A-CEA□□□S
50 W	R7M-A05030-S1	R7D-APA5H	R7A-CEA□□□S
100 W	R7M-A10030-S1	R7D-AP01H	R7A-CEA□□□S
200 W	R7M-A20030-S1	R7D-AP02H	R7A-CEA□□□S
400 W	R7M-A40030-S1	R7D-AP04H	R7A-CEA□□□S
750 W	R7M-A75030-S1	R7D-AP08H	R7A-CEA□□□S
Cylindrical Servo Motors 200 VAC With Brake, Shaft With Keyway			
30 W	R7M-A03030-BS1	R7D-APA3H	R7A-CEA□□□B
50 W	R7M-A05030-BS1	R7D-APA5H	R7A-CEA□□□B
100 W	R7M-A10030-BS1	R7D-AP01H	R7A-CEA□□□B
200 W	R7M-A20030-BS1	R7D-AP02H	R7A-CEA□□□B
400 W	R7M-A40030-BS1	R7D-AP04H	R7A-CEA□□□B
750 W	R7M-A75030-BS1	R7D-AP08H	R7A-CEA□□□B
Flat Servo Motors 100 VAC Without Brake, Shaft With Keyway			
100 W	R7M-AP10030-S1	R7D-AP01L	R7A-CEA□□□S
200 W	R7M-AP20030-S1	R7D-AP02L	R7A-CEA□□□S
400 W	R7M-AP40030-S1	R7D-AP04L	R7A-CEA□□□S
Flat Servo Motors 100 VAC With Brake, Shaft With Keyway			
100 W	R7M-AP10030-BS1	R7D-AP01L	R7A-CEA□□□B
200 W	R7M-AP20030-BS1	R7D-AP02L	R7A-CEA□□□B
400 W	R7M-AP40030-BS1	R7D-AP04L	R7A-CEA□□□B
Flat Servo Motors 200 VAC Without Brake, Shaft With Keyway			
100 W	R7M-AP10030-S1	R7D-AP01H	R7A-CEA□□□S
200 W	R7M-AP20030-S1	R7D-AP02H	R7A-CEA□□□S
400 W	R7M-AP40030-S1	R7D-AP04H	R7A-CEA□□□S
750 W	R7M-AP75030-S1	R7D-AP08H	R7A-CEA□□□S
Flat Servo Motors 200 VAC With Brake, Shaft With Keyway			
100 W	R7M-AP10030-BS1	R7D-AP01H	R7A-CEA□□□B
200 W	R7M-AP20030-BS1	R7D-AP02H	R7A-CEA□□□B
400 W	R7M-AP40030-BS1	R7D-AP04H	R7A-CEA□□□B
750 W	R7M-AP75030-BS1	R7D-AP08H	R7A-CEA□□□B

Cables and Accessories

Description	Devices connected	Specification	Model
② Servo relay units connect cables from PLC position controller and servo drive	CS1W-NC113/133, CJ1W-NC113/133; 1 axis; does not support communications functions	—	XW2B-20J6-1B
	CS1W-NC213/233/413/433, CJ1W-NC213/233/413/433; 2 axes; does not support communications functions	—	XW2B-40J6-2B
	CQM1H-PLB21 and CQM1-CPU43-V1; 1 axis; does not support communications functions	—	XW2B-20J6-3B
	CS1W-NC213/233/413/433, CJ1W-NC213/233/413/433; 2 axes; supports communications functions	—	XW2B-40J6-4A
	CJ1M-CPU22/23; 1 axis; does not support communications functions	—	XW2B-20J6-8A
	CJ1M-CPU22/23; 2 axes; does not support communications functions	—	XW2B-40J6-9A
③ Universal terminal block cable to servo drive	Doesn't support communications functions. (For the XW2B-□□J6-□B)	1 m length	XW2Z-100J-B5
		2 m length	XW2Z-200J-B5
④ Position controller PLC module cable	CQM1H-PLB21 and CQM1-CPU43-V1 to XW2B-20J6-3B servo relay unit	1 m length	XW2Z-100J-A3
	CJ1W-NC113 to XW2B-20J6-1B servo relay unit	1 m length	XW2Z-100J-A16
	CJ1W-NC213 or CJ1W-NC413 to XW2B-20J6-2B servo relay unit	1 m length	XW2Z-100J-A17
	CJ1W-NC133 to XW2B-20J6-1B servo relay unit	1 m length	XW2Z-100J-A20
	CJ1W-NC233 or CJ1W-NC433 to XW2B-40J6-2B servo relay unit	1 m length	XW2Z-100J-A21
	CJ1M-CPU22 or CJ1M-CPU23 to XW2B-20J6-8A (1 axis) or XW2B-40J6-9A (2 axes) servo relay unit	1 m length	XW2Z-100J-A26
	CS1W-NC113 to XW2B-20J6-1B servo relay unit	1 m length	XW2Z-100J-A8
	CS1W-NC213 or CS1W-NC413 to XW2B-40J6-2B servo relay unit	1 m length	XW2Z-100J-A9
	CS1W-NC133 to XW2B-20J6-B1 servo relay unit	1 m length	XW2Z-100J-A12
	CS1W-NC233 or CS1W-NC433 to XW2B-40J6-2B servo relay unit	1 m length	XW2Z-100J-A13
⑤ Control cable	For general-purpose Controllers (mating connector for CJ1 on one end, open ended on the other end)	1 m length	R88A-CPU001S
		2 m length	R88A-CPU002S
⑥ Universal terminal block	For position control modules with pulse output and general-purpose controllers	—	XW2B-40F5-P
	Connector cable between terminal block and servo driver	1 m length	R88A-CTU001N
		2 m length	R88A-CTU002N
⑦ Analog monitor cable (port CN4)	Servo drive to PC	1 m length	R88A-CMW001S
⑧ Computer monitor cable (port CN3)	Servo drive to PC	2 m length	R7A-CCA002P2
Filters	For servo drive R7D-APA3H, APA5H, AP01H, AP02H; R7D-APA3L, APA5L, AP01L, AP02L	4 A, 250 VAC single phase	R88A-FIW104-E
	For servo drive R7D-AP04H, AP04L	7 A, 250 VAC single phase	R88A-FIW107-E
	For servo drive R7D-AP08H	15 A, 250 VAC single phase	R88A-FIW115-E
Control I/O connector (CN1)	—	—	R88A-CNU01C
SmartStep encoder connector (CN2)	—	—	R7A-CNA01R
External regeneration resistor	—	200 W, 47 Ω	R88A-RR22047S
Parameter copy unit with cable	—	—	R7A-PR02A
Configuration and monitoring software	For servo drives and inverters	Version 1.11 or higher	CX-DRIVE
Complete OMRON software suite	Includes CX-Drive	—	CX-ONE

Specifications

Servo Drives General Specifications

Item	Specification
Operating ambient	0° to 55° C (32° F to 131° F), 90% RH max. (with no condensation)
Storage ambient	-20° to 85° C (-4° F to 185° F), 90% RH max. (with no condensation)
Storage/operating atmosphere	No corrosive gases.
Vibration resistance	10 to 55 Hz in X, Y, and Z directions with 0.1-mm double amplitude or acceleration of 4.9 m/s ² max., whichever is smaller
Impact resistance	Acceleration 19.6 m/s ² max., in X, Y, and Z directions, three times
Insulation resistance	Between power line terminals and case: 0.5 MΩ min. (at 500 VDC)
Dielectric strength	Between power line terminals and case: 1,500 VAC for 1 min. at 50/60 Hz between each control signal and case: 500 VAC for 1 min.
Protective structure	Built into panel (IP10).
International standards	Approval obtained for UL, cUL, and EN (EMC directive and low-voltage directive)

Servo Drives Performance Specifications

100 VAC Input Models

Item	Specification				
Model	R7D-APA3L	R7D-APA5L	R7D-AP01L	R7D-AP02L	R7D-AP04L
Rated output	30 W	50 W	100 W	200 W	400 W
Continuous output current (rms)	0.42	0.6	0.89	2.0	2.6
Momentary maximum output current (rms)	1.3	1.9	2.8	6.0	8.0
Control power supply	Single-phase 100/115 VAC (85 to 127 V) 50/60 Hz				
Main-circuit power supply	Single-phase 100/115 VAC (85 to 127 V) 50/60 Hz (Voltage doubler method)				
Control method	All-digital servo				
Speed feedback	2,000 pulses/revolution Incremental Encoder				
Inverter method	PWM method based on IGBT				
PWM frequency	11.7 kHz				
Weight [kg (lb)]	0.8 (1.76)	0.8 (1.76)	0.8 (1.76)	0.8 (1.76)	1.1 (2.43)
Compatible motor voltage	200 V				
Compatible motor capacity	30 W	50 W	100 W	200 W	400 W
Command pulse response	250 kHz				
Applicable servo motor (R7M-)	A03030_	A05030_	A10030_	A20030_	A40030_
	—	—	AP10030_	AP20030_	AP40030_

200 VAC Input Models

Item	Specification					
Model	R7D-APA3H	R7D-APA5H	R7D-AP01H	R7D-AP02H	R7D-AP04H	R7D-AP08H
Rated output	30 W	50 W	100 W	200 W	400 W	750 W
Continuous output current (rms)	0.42	0.6	0.89	2.0	2.6	4.4
Momentary maximum output current (rms)	1.3	1.9	2.8	6.0	8.0	13.9
Control power supply	Single-phase 200/230 VAC (170 to 253 V) 50/60 Hz					
Main-circuit power supply	Single-phase 200/230 VAC (170 to 253 V) 50/60 Hz (Three-phase 200/230 VAC can be used with the 750 W model)					
Control method	All-digital servo					
Speed feedback	2,000 pulses/revolution incremental encoder					
Inverter method	PWM method based on IGBT					
PWM frequency	11.7 kHz					
Weight [kg (lb)]	0.8 (1.76)	0.8 (1.76)	0.8 (1.76)	0.8 (1.76)	1.1 (2.43)	1.7 (3.75)
Servo motor voltage	200 V					
Servo motor capacity	30 W	50 W	100 W	200 W	400 W	750 W
Command pulse response	250 kHz					
Applicable servo motor (R7M-)	A03030	A05030	A10030	A20030	A40030	A75030
	—	—	AP10030	AP20030	AP40030	AP75030

Servo Motor General Specifications

Item	Specification
Operating ambient	0°C to 40°C (32°F to 104°F), 20% to 80% RH (with no condensation)
Storage ambient	-20°C to 60°C (-4°F to 140°F), 20% to 80% RH (with no condensation)
Storage/operating atmosphere	No corrosive gases
Vibration resistance	10 to 2,500 Hz in X, Y, and Z directions with 0.2 mm double amplitude or acceleration of 24.5 m/s ² max., whichever is smaller
Impact resistance	Acceleration 98 m/s ² max., in a vertical direction, two times
Insulation resistance	Between power line terminals and FG: 10 MΩ min. (at 500 VDC)
Dielectric strength	Between power line terminals and FG: 1,500 V AC for 1 min at 50/60 Hz
Run position	Any direction
Insulation grade	Type B
Structure	Totally-enclosed self-cooling
Protective structure	IP55 for both the cylindrical and flat servo motors
Vibration grade	V-15
Mounting method	Flange-mounting
International standards	Approval obtained for UL, cUL, and EN (EMC directive and low-voltage directive)

Servo Motor Performance Specifications

Flat Servo Motors without Brakes

Item	R7M-AP10030-S1	R7M-AP20030-S1	R7M-AP40030-S1	R7M-AP75030-S1
Rated output	100 W	200 W	400 W	750 W
Rated torque	0.318 N•m	0.637 N•m	1.27 N•m	2.39 N•m
Rated rotation speed	3,000 r/min.	3,000 r/min.	3,000 r/min.	3,000 r/min.
Momentary maximum rotation speed	4,500 r/min.	4,500 r/min.	4,500 r/min.	4,500 r/min.
Momentary maximum torque	0.96 N•m	1.91 N•m	3.82 N•m	7.1 N•m
Rated current	0.89 A (rms)	2.0 A (rms)	2.6 A (rms)	4.1 A (rms)
Momentary maximum current	2.8 A (rms)	6.0 A (rms)	8.0 A (rms)	13.9 A (rms)
Rotor inertia	6.5 × 10 ⁻⁶ kg•m ²	2.09 × 10 ⁻⁵ kg•m ²	3.47 × 10 ⁻⁵ kg•m ²	2.11 × 10 ⁻⁴ kg•m ²
Power rate	15.7 kW/s	19.4 kW/s	46.8 kW/s	26.9 kW/s
Allowable radial load	78 N	245 N	245 N	392 N
Allowable thrust load	49 N	68 N	68 N	147 N
Weight (without brake -S1)	0.7 kg	1.4 kg	2.1 kg	4.2 kg
Applicable servo driver	R7D-AP01H/L	R7D-AP02H/L	R7D-AP04H/L	R7D-AP08H
Encoder resolution	2,000 pulses/revolution for phase-A and phase-B, 1 pulse/revolution for phase-Z			
Radiation shield dimensions	t6 x250 mm square			t12 x300 mm square

Flat Servo Motors with Brakes

Item	R7M-AP10030-BS1	R7M-AP20030-BS1	R7M-AP40030-BS1	R7M-AP75030-BS1	
Rated output	100 W	200 W	400 W	750 W	
Rated torque	0.318 N•m	0.637 N•m	1.27 N•m	2.39 N•m	
Rated rotation speed	3,000 r/min.	3,000 r/min.	3,000 r/min.	3,000 r/min.	
Momentary maximum rotation speed	4,500 r/min.	4,500 r/min.	4,500 r/min.	4,500 r/min.	
Momentary maximum torque	0.96 N•m	1.91 N•m	3.82 N•m	7.1 N•m	
Rated current	0.89 A (rms)	2.0 A (rms)	2.6 A (rms)	4.1 A (rms)	
Momentary maximum current	2.8 A (rms)	6.0 A (rms)	8.0 A (rms)	13.9 A (rms)	
Rotor inertia	6.5 × 10 ⁻⁶ kg•m ²	2.09 × 10 ⁻⁵ kg•m ²	3.47 × 10 ⁻⁵ kg•m ²	2.11 × 10 ⁻⁴ kg•m ²	
Power rate	15.7 kW/s	19.4 kW/s	46.8 kW/s	26.9 kW/s	
Allowable radial load	78 N	245 N	245 N	392 N	
Allowable thrust load	49 N	68 N	68 N	147 N	
Weight (with brake -BS1)	0.9 kg	1.9 kg	2.6 kg	5.7 kg	
Applicable servo driver	R7D-AP01H/L	R7D-AP02H/L	R7D-AP04H/L	R7D-AP08H	
Encoder resolution	2,000 pulses/revolution for phase-A and phase-B, 1 pulse/revolution for phase-Z				
Radiation shield dimensions	t6 x250 mm square			t12 x300 mm square	
Brake specifications	Brake inertia	3.1 × 10 ⁻⁶ kg•m ²	1.52 × 10 ⁻⁵ kg•m ²	1.52 × 10 ⁻⁵ kg•m ²	8.75 × 10 ⁻⁵ kg•m ²
	Excitation voltage	24 V DC ±10%			
	Power consumption (at 20°C)	6 W	5 W	7.6 W	7.5 W
	Current consumption (at 20°C)	0.25 A	0.21 A	0.32 A	0.31 A
	Static friction torque	0.4 N•m min.	0.9 N•m min.	1.9 N•m min.	3.5 N•m min.
	Attraction time	40 ms max.	40 ms max.	40 ms max.	40 ms max.
	Release time	20 ms max.	20 ms max.	20 ms max.	20 ms max.
	Backlash	1°	1°	1°	1°
	Rating	Continuous			
Insulation grade	Type F				

Cylindrical Servo Motors without Brakes

Item	R7M-A03030-S1	R7M-A05030-S1	R7M-A10030-S1	R7M-A20030-S1	R7M-A40030-S1	R7M-A75030-S1
Rated output	30 W	50 W	100 W	200 W	400 W	750 W
Rated torque	0.095 N•m	0.159 N•m	0.318 N•m	0.637 N•m	1.27 N•m	2.39 N•m
Rated rotation speed	3,000 r/min.	3,000 r/min.	3,000 r/min.	3,000 r/min.	3,000 r/min.	3,000 r/min.
Momentary maximum rotation speed	4,500 r/min.	4,500 r/min.	4,500 r/min.	4,500 r/min.	4,500 r/min.	4,500 r/min.
Momentary maximum torque	0.29 N•m	0.48 N•m	0.96 N•m	1.91 N•m	3.82 N•m	7.1 N•m
Rated current (rms)	0.42 A	0.6 A	0.87 A	2.0 A	2.6 A	4.4 A
Momentary maximum current (rms)	1.3 A	1.9 A	2.8 A	6.0 A	8.0 A	13.9 A
Rotor inertia	$1.7 \times 10^{-6} \text{ kg}\cdot\text{m}^2$	$2.2 \times 10^{-6} \text{ kg}\cdot\text{m}^2$	$3.6 \times 10^{-6} \text{ kg}\cdot\text{m}^2$	$1.19 \times 10^{-5} \text{ kg}\cdot\text{m}^2$	$1.87 \times 10^{-5} \text{ kg}\cdot\text{m}^2$	$6.67 \times 10^{-5} \text{ kg}\cdot\text{m}^2$
Power rate	5.31 kW/s	11.5 kW/s	28.1 kW/s	34.1 kW/s	86.3 kW/s	85.6 kW/s
Allowable radial load	68 N	68 N	78 N	245 N	245 N	392 N
Allowable thrust load	54 N	54 N	54 N	74 N	74 N	147 N
Weight without brake	0.3 kg	0.4 kg	0.5 kg	1.1 kg	1.7 kg	3.4 kg
Applicable servo driver	R7D-APA3H	R7D-APA5H	R7D-AP01H	R7D-AP02H	R7D-AP04H	R7D-AP08H
Encoder resolution	2,000 pulses/revolution for phase-A and phase-B, 1 pulse/revolution for phase-Z					
Radiation shield dimensions	t6× 250 mm square					

Cylindrical Servo Motors with Brakes

Item	R7M-A03030-BS1	R7M-A05030-BS1	R7M-A10030-BS1	R7M-A20030-BS1	R7M-A40030-BS1	R7M-A75030-BS1	
Rated output	30 W	50 W	100 W	200 W	400 W	750 W	
Rated torque	0.095 N•m	0.159 N•m	0.318 N•m	0.637 N•m	1.27 N•m	2.39 N•m	
Rated rotation speed	3,000 r/min.	3,000 r/min.	3,000 r/min.	3,000 r/min.	3,000 r/min.	3,000 r/min.	
Momentary maximum rotation speed	4,500 r/min.	4,500 r/min.	4,500 r/min.	4,500 r/min.	4,500 r/min.	4,500 r/min.	
Momentary maximum torque	0.29 N•m	0.48 N•m	0.96 N•m	1.91 N•m	3.82 N•m	7.1 N•m	
Rated current (rms)	0.42 A	0.6 A	0.87 A	2.0 A	2.6 A	4.4 A	
Momentary maximum current (rms)	1.3 A	1.9 A	2.8 A	6.0 A	8.0 A	13.9 A	
Rotor inertia	$1.7 \times 10^{-6} \text{ kg}\cdot\text{m}^2$	$2.2 \times 10^{-6} \text{ kg}\cdot\text{m}^2$	$3.6 \times 10^{-6} \text{ kg}\cdot\text{m}^2$	$1.19 \times 10^{-5} \text{ kg}\cdot\text{m}^2$	$1.87 \times 10^{-5} \text{ kg}\cdot\text{m}^2$	$6.67 \times 10^{-5} \text{ kg}\cdot\text{m}^2$	
Power rate	5.31 kW/s	11.5 kW/s	28.1 kW/s	34.1 kW/s	86.3 kW/s	85.6 kW/s	
Allowable radial load	68 N	68 N	78 N	245 N	245 N	392 N	
Allowable thrust load	54 N	54 N	54 N	74 N	74 N	147 N	
Weight with brake	0.6 kg	0.7 kg	0.8 kg	1.6 kg	2.2 kg	4.3 kg	
Applicable servo driver	R7D-APA3H	R7D-APA5H	R7D-AP01H	R7D-AP02H	R7D-AP04H	R7D-AP08H	
Encoder resolution	2,000 pulses/revolution for phase-A and phase-B, 1 pulse/revolution for phase-Z						
Radiation shield dimensions	t6× 250 mm square						
Brake specifications	Brake inertia	$0.85 \times 10^{-6} \text{ kg}\cdot\text{m}^2$	$0.85 \times 10^{-6} \text{ kg}\cdot\text{m}^2$	$0.85 \times 10^{-6} \text{ kg}\cdot\text{m}^2$	$6.4 \times 10^{-6} \text{ kg}\cdot\text{m}^2$	$6.4 \times 10^{-6} \text{ kg}\cdot\text{m}^2$	$1.7 \times 10^{-5} \text{ kg}\cdot\text{m}^2$
	Excitation voltage	24 V DC ±10% V					
	Power consumption (at 20° C)	6 W	6 W	6 W	7 W	7 W	7.7 W
	Current consumption (at 20° C)	0.25 A	0.25 A	0.25 A	0.29 A	0.29 A	0.32 A
	Static friction torque	0.2 N•m min.	0.2 N•m min.	0.34 N•m min.	1.47 N•m min.	1.47 N•m min.	2.45 N•m min.
	Attraction time	30 ms max.	30 ms max.	30 ms max.	60 ms max.	60 ms max.	60 ms max.
	Release time	60 ms max.	60 ms max.	60 ms max.	20 ms max.	20 ms max.	20 ms max.
	Backlash	1°	1°	1°	1°	1°	1°
	Rating	Continuous	Continuous	Continuous	Continuous	Continuous	Continuous
Insulation grade	Type F	Type F	Type F	Type F	Type F	Type F	

Dimensions

Servo Drives Dimensions (mm)

Input voltage	Rating	Drive model	H	W	D
1-phase, 100 VAC and 200 VAC	30 W	R7D-APA3H/L	160	55	130
	50 W	R7D-APA5H/L	160	55	130
	100 W	R7D-AP01H/L	160	55	130
	200 W	R7D-AP02H/L	160	55	130
	400 W	R7D-AP04H/L	160	75	130
1-phase, 200 VAC	750 W	R7D-AP08H	160	90	180

Cylindrical Servo Motors (3,000 r/min) Dimensions (mm)

200 VAC: 30 W/50 W/100 W/200 W/400 W/750 W

Without brake: R7M-A03030-S1-D/A05030-S1-D/A10030-S1-D/A20030-S1-D/A40030-S1-D/A75030-S1-D

With brake: R7M-A03030-BS1-D/A05030-BS1-D/A10030-BS1-D/A20030-BS1-D/A40030-BS1-D/A75030-BS1-D

R7M-A□□□30(-S1) (Without Brake)

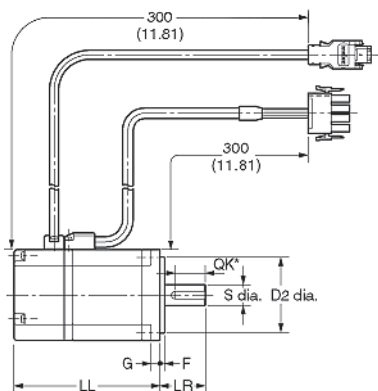

R7M-A□□□30(-S1) (With Brake)

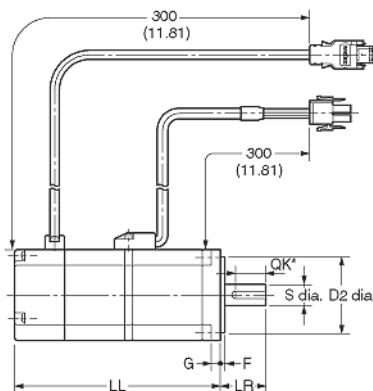

*Axis End Dimensions

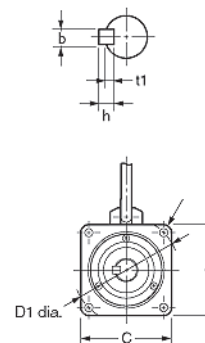

Model	Overall length		Flange surface			Axis end							
	LL	LR	C	D1	D2	F	G	Z	S	QK	b	h	t1
R7M-A03030-S1	69.5	25	40	46	30h7	2.5	5	Two, 4.3 dia.	6h6	14	2	2	1.2
R7M-A03030-BS1	101	25	40	46	30h7	2.5	5	Two, 4.3 dia.	6h6	14	2	2	1.2
R7M-A05030-S1	77	25	40	46	30h7	2.5	5	Two, 4.3 dia.	6h6	14	2	2	1.2
R7M-A05030-BS1	108.5	25	40	46	30h7	2.5	5	Two, 4.3 dia.	6h6	14	2	2	1.2
R7M-A10030-S1	94.5	25	40	46	30h7	2.5	5	Two, 4.3 dia.	8h6	14	3	3	1.8
R7M-A10030-BS1	135	25	40	46	30h7	2.5	5	Two, 4.3 dia.	8h6	14	3	3	1.8
R7M-A20030-S1	96.5	30	60	70	50h7	3	6	Four, 5.5 dia.	14h6	20	5	5	3
R7M-A20030-BS1	136	30	60	70	50h7	3	6	Four, 5.5 dia.	14h6	20	5	5	3
R7M-A40030-S1	124.5	30	60	70	50h7	3	6	Four, 5.5 dia.	14h6	20	5	5	3
R7M-A40030-BS1	164	30	60	70	50h7	3	6	Four, 5.5 dia.	14h6	20	5	5	3
R7M-A75030-S1	145	40	80	90	70h7	3	8	Four, 7 dia.	16h6	30	5	5	3
R7M-A75030-BS1	189.5	40	80	90	70h7	3	8	Four, 7 dia.	16h6	30	5	5	3

Flat Servo Motors (3,000 r/min) Dimensions (mm)

200 VAC: 100 W/200 W/400 W/750 W

Without brake: R7M-AP10030-S1-D/AP20030-S1-D/AP40030-S1-D/AP75030-S1-D

With brake: R7M-AP10030-BS1-D/AP20030-BS1-D/AP40030-BS1-D/AP75030-BS1-D

R7M-AP□□□30(-S1) (Without Brake)

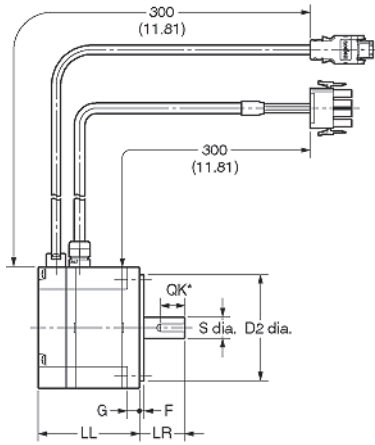

R7M-AP□□□30(-S1) (With Brake)

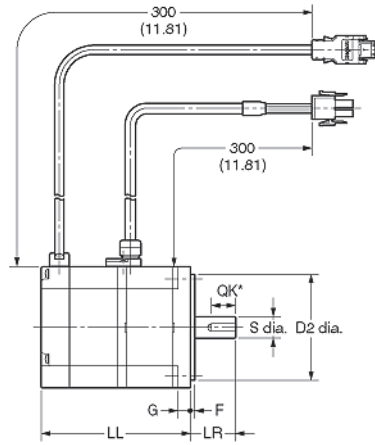

*Axis End Dimensions

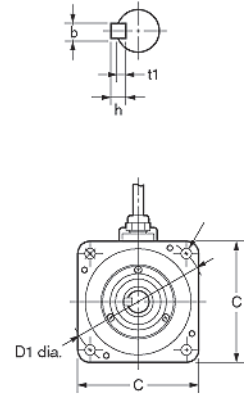

Model	Overall length		Flange surface			Axis end							
	LL	LR	C	D1	D2	F	G	Z	S	QK	b	h	t1
R7M-AP10030-S1	62	25	60	70	50h7	2.5	6	5.5 dia.	8h6	14	3	3	1.8
R7M-AP10030-BS1	91	25	60	70	50h7	2.5	6	5.5 dia.	8h6	14	3	3	1.8
R7M-AP20030-S1	67	30	80	90	70h7	3	8	7 dia.	14h6	16	5	5	3
R7M-AP20030-BS1	98.5	30	80	90	70h7	3	8	7 dia.	14h6	16	5	5	3
R7M-AP40030-S1	87	30	80	90	70h7	3	8	7 dia.	14h6	16	5	5	3
R7M-AP40030-BS1	118.5	30	80	90	70h7	3	8	7 dia.	14h6	16	5	5	3
R7M-AP75030-S1	86.5	40	120	145	110h7	3.5	10	10 dia.	16h6	22	5	5	3
R7M-AP75030-BS1	120	40	120	145	110h7	3.5	10	10 dia.	16h6	22	5	5	3

Inverters

3G3JV

Quick Link

A031

Compact AC Inverter for Simple Motor Control

- Easy-to-use digital operator controls all parameter selections and settings
- Quick Start LEDs for quick setup and troubleshooting
- Fine-tune speed using the potentiometer on the digital operator
- Ideal for simple, small motor control applications — uses V/Hz control method
- Programmable output frequency, 400 Hz maximum
- Modbus serial communications
- Compact size: 5.04 H x 5.04 W x 6.34 D inches max. (230 VAC)
 - 5.04 H x 5.51 W x 6.34 D inches max. (460 VAC)



Specifications

Power supply		
Rated input voltage & frequency	3-phase, 200 to 230 V, 50/60 Hz Single-phase, 200 to 240 V, 50/60 Hz	3-phase, 380 to 460 V, 50/60 Hz
Allowable voltage fluctuation	-15% to +10%	
Allowable frequency fluctuation	±5%	
Control characteristics		
Control method	Sine Wave PWM (V/f control), possible to program any V/f pattern	
Frequency control range	0.1 to 400 Hz	
Frequency accuracy (temperature change)	Digital reference: ±0.01%, 14 to 122°F (-10 to +50°C) Analog reference: ±0.5%, 59 to 95°F (25±10°C)	
Frequency setting resolution	Digital reference: 0.1 Hz (less than 100 Hz)/1 Hz (100 Hz or more) Analog reference: (0:06/60 Hz) equivalent to 1/1000 of max. output frequency	
Output frequency resolution	0.01 Hz	
Overload capacity	150% rated output current for one minute	
Frequency setting signal	0 to 10 VDC (20 kΩ), 4 to 20 mA (250 Ω), 0 to 20 mA (250 Ω) frequency setting volume (selectable)	
Accel/Decel	0.1 to 999 sec. (accel./decel. time are independently programmed)	
Braking torque	Short-term average deceleration torque 0.13 HP, 0.25 HP: 150%; 0.5 HP, 1 HP: 100%; 2 HP: 50%; 3 HP or more: 20% Continuous regenerative torque: Approx. 20%	
Protective functions		
Motor overload protection	UL-recognized electronic thermal overload relay	
Instantaneous overcurrent	Motor coasts to a stop at approximately 250% rated output current	
Overload	Motor coasts to a stop after one minute at 150% rated output current Motor coasts to a stop at approximately 200% rated output current	
Overvoltage	Motor coasts to a stop if DC bus voltage exceed 410 V	Motor coasts to a stop if DC bus voltage exceeds 820 V
Undervoltage	Stops when DC bus voltage is approximately 200 V or less (approx. 160 V or less for single-phase series)	Stops when DC bus voltage is approximately 400 V or less
Momentary power loss	Stops if power loss is 15 ms or more. By setting inverter, operation can be continued if power is restored within approximately 0.5 s	
Cooling method	Cooling fan is provided for: 230 V, 1 HP or larger inverters (3-phase); 460 V, 2 HP or larger inverters (single-phase); other models are self-cooling	
Cooling fin overheat	Protected by electronic circuit	

Specifications (Continued)

Cooling fan fault	Protected by electronic circuit (fan-stalling detection)
Stall prevention	Individual levels during acceleration/running, enable/disable provided during deceleration
Ground fault	Protected by electronic circuit (rated output current level)
Power charge indication	RUN lamp stays ON or digital operator LED stays ON. (Charge LED is provided for 460 V) ON until the DC bus voltage becomes 50 V or less
Environmental conditions	
Enclosure rating	Open chassis: IP20
Location	Indoor (free from corrosive gases and dust)
Ambient temperature	Open chassis: 14 to 122°F (-10 to +50°C), not frozen
Storage temperature	-4 to 140°F (-20 to 60°C)
Humidity	95% RH (Non-condensing)
Elevation	1,000 m (3,281 feet) or below
Wiring distance	328 ft (100 m) or less between inverter and motor
Vibration	9.8 m/s ² (1G) less than 20 Hz, up to 1.96 m/s ² (0.2G) at 20 to 50 Hz
Other functions	
Multi-function inputs	Four of the following input signals are selectable: Reverse run (3-wire sequence), fault reset, external fault (NO/NC contact input), multi-step speed operation, Jog command, accel/decel time select, external baseblock (NO/NC contact input), speed search command, accel/decel hold command, LOCAL/REMOTE selection, communication/control circuit terminal selection, emergency stop fault, emergency stop alarm.
Multi-function outputs	Following output signals are selectable (1 NO/NC contact output): Fault, running, zero speed, at frequency, frequency detection (output frequency = or = set value), during overtorque detection, minor error, during baseblock, operation mode, inverter run ready, during fault retry, during under-voltage, during speed search, data output through communication.
Standard functions	Full-range automatic torque boost, slip compensation, DC injection braking current/time at start/stop frequency reference bias/gain, frequency reference with built-in potentiometer, MEMOBUS communications (RS-485/422, max. 19.2 K bps) capable with optional unit.

3G3JV Inverter Ordering Information

Description	Enclosure	Rating			Model
		HP	Voltage	Phase	
Compact inverter with V/Hz control	NEMA 1	1/8	240	1	3G3JV-AB001-A
		1/4	240	1	3G3JV-AB002-A
		3/4	240	1	3G3JV-AB004-A
		1	240	1	3G3JV-AB007-A
		2	240	1	3G3JV-AB015-A
		1/8	230	3	3G3JV-A2001-A
		1/4	230	3	3G3JV-A2002-A
		3/4	230	3	3G3JV-A2004-A
		1	230	3	3G3JV-A2007-A
		2	230	3	3G3JV-A2015-A
	3	230	3	3G3JV-A2022-A	
	5	230	3	3G3JV-A2037-A	
	Open chassis	1/2	460	3	3G3JV-A4002-A
		1	460	3	3G3JV-A4004-A
		2	460	3	3G3JV-A4007-A
		3	460	3	3G3JV-A4015-A
		3	460	3	3G3JV-A4022-A
	5	460	3	3G3JV-A4037-A	

Manuals

Item	Description	Model
User's manual	3G3JV User's manual	I528-E3-1

Inverters

3G3MV

Quick Link
A032

Versatile Compact Inverter Offers Loop Vector and V/Hz Control

- Intuitive digital operator controls all parameter selections and settings
- Quick Start LEDs for fast setup and troubleshooting
- Standard PID control
- Modbus serial communications standard
- DeviceNet communications unit (optional) allows remote monitoring of Run/Stop status and operating conditions, and making changes to set values
- Fine-tune speed using the potentiometer on the digital operator
- User-selectable open loop vector and V/Hz control methods
- NEMA 4X models meet requirements for tough washdown and dust-tight environments
- NEMA 1 models available
- Compact size: Single phase, 230 VAC: 148 H x 170 W x 180 D mm max.
 - Three-phase, 230 VAC: 260 H x 180 W x 170 D mm max.
 - Three-phase, 460 VAC: 260 H x 180 W x 170 D mm max.
- Integrate a full-featured PLC into 3G3MV inverters with 6 input/4 output points, encoder input, interrupt inputs and pulse outputs; dual port RAM for 200 transfers per second; eliminates point-to-point wiring



Specifications

General Specifications

Power supply		
Rated input voltage & frequency	3-phase, 200 to 230 V, 50/60 Hz Single-phase, 200 to 240 V, 50/60 Hz	3-phase, 380 to 460 V, 50/60 Hz
Allowable voltage fluctuation	-15% to +10%	
Allowable frequency fluctuation	±5%	
Control characteristics		
Control method	Sine wave PWM (V/f control or voltage vector control, selectable); possible to program any V/f pattern	
Frequency control range	0.1 to 400 Hz	
Frequency accuracy (temperature change)	Digital reference: ±0.01%, 14 to 122°F (-10 to +50°C) Analog reference: ±0.5%, 59 to 95°F (25±10°C)	
Frequency setting resolution	Digital reference: 0.1 Hz (less than 100 Hz)/0.1 Hz (100 Hz or more) Analog reference: (0:06/60 Hz) equivalent to 1/1000 of max. output frequency	
Output frequency resolution	0.01 Hz	
Overload capacity	150% rated output current for one minute	
Frequency setting signal	0 to 10 VDC (20 kΩ), 4 to 20 mA (250 Ω), 0 to 20 mA (250 Ω) pulse train input, frequency setting potentiometer (Selectable)	
Accel/Decel	0.01 to 6000 seconds (accel/decel time are independently programmed 2 types)	
Braking torque	Short-term average deceleration torque: 0.1, 0.25 kW (0.13 HP, 0.25 HP): 150%; 0.55, 1.1 kW): (0.5 HP, 1 HP): 100% 1.5 kW (2 HP): 50%; 2.2 kW (3 HP) or more: 20% Continuous regenerative torque: Approx. 20% (150% with optional braking resistor, braking transistor built-in)	

General Specifications (Continued)

Protective functions	
Motor overload protection	UL-recognized electronic thermal overload relay
Instantaneous overcurrent	Motor coasts to a stop at approximately 250% inverter rated current
Overload	Motor coasts to a stop after one minute at 150% rated output current
Overvoltage	Motor coasts to a stop if DC bus voltage exceeds 410 V Motor coasts to a stop if DC bus voltage exceeds 820 V
Undervoltage	Stops when DC bus voltage is approximately 200 V or less (approx. 160 V or less for single-phase series) Stops when DC bus voltage is approximately 400 V or less
Momentary power loss	Stops if power loss is 15 ms or more. By setting inverter, operation can be continued if power is restored within approximately 0.5 s
Cooling method	Cooling fan is provided for the following models: 200 V, 0.75 kW or larger inverters (3-phase) 200 V, 1.5 kW or larger inverters (single-phase) Others models are self-cooling
Cooling fin overheat	Protected by electronic circuit
Cooling fan fault	Protected by electronic circuit (fan lock detection)
Stall prevention	Individual levels during acceleration/running, enable/disable provided during coast to a stop
Ground fault	Protected by electronic circuit (overcurrent level)
Power charge indication	ON until the DC bus voltage becomes 50 V or less. RUN lamp stays ON or digital operator LED stays ON.
Environmental conditions	
Enclosure rating	Enclosed wall mounted NEMA 1
Location	Indoor (free from corrosive gases and dust)
Ambient temperature	Enclosed wall mounted NEMA 1: 14 to 105° F (-10 to +40°C), not frozen
Storage temperature	-4 to 140°F (-20 to 60°C)
Humidity	95% RH or less (Non-condensing)
Elevation	1,000 m (3,281 feet) or below
Wiring distance	328 ft (100 m) or less between inverter and motor
Vibration	9.8 m/s ² (1G) less than 20 Hz, up to 2 m/s ² (0.2G) at 20 to 50 Hz
Other functions	
Multi-function inputs	Seven of the following input signals are selectable: Forward/reverse run (3-wire sequence), fault reset, external fault (NO/NC contact input), multi-step speed operation, Jog command, accel/decel time select, external base block (NO/NC contact input), speed search command, UP/DOWN command, accel/decel hold command, LOCAL/REMOTE selection, communication/control circuit terminal selection, emergency stop fault, emergency stop alarm, self test, PID control cancel, PID integral reset/hold
Multi-function outputs	Following output signals are selectable (1 NO/NC contact output, 2 photo-coupler outputs): Fault, running, zero speed, at frequency, frequency detection (output frequency = or = set value), during overtorque detection, during undervoltage detection, minor error, during baseblock, operation mode, inverter run ready, during fault retry, during UV, during speed search, data output through communication, PID feedback loss detection
Standard functions	Voltage vector control, full-range automatic torque boost, slip compensation, DC injection braking current/time at start/stop frequency reference bias/gain, MEMOBUS communications (RS-485/422, max. 19.2 K bps), PID control, energy-saving control, parameter copy, frequency reference with built-in potentiometer

Inverter PLC Specifications

Model	3G3MV-P10CDT3-E	3G3MV-P10CDT-E
Type	Full feature PLC installs on face of 3G3MV inverters with 1/4 to 10 HP rating	
I/O points	6 input points (bi-directional input at 5 kHz; unidirectional input at 20 kHz) 4 output points (1 relay, 3 NPN transistor); I/O can be set for interrupt inputs (50 μs response) or pulse outputs	
Clock/calendar	Yes	No
Encoder interface	Yes	Yes
Connectivity	Direct HMI connection Peripheral port Serial ports: RS-232C, RS-422/485	Direct HMI connection Peripheral port RS-232C serial port
Memory backup	Flash memory and battery	Flash memory and capacitor
Dimensions	128 H x 68 W x 38.1 D mm	
Software	CX-Programmer included in CX-One	

Ordering Information

MV Inverter

Description	Enclosure	Rating			Model	
		HP	Voltage	Phase	NEMA 1 enclosure	NEMA 4X enclosure
Compact inverter with open loop vector and V/Hz control methods	NEMA 1 and NEMA 4X models available	1/8	230	1	3G3MV-CB001	—
		1/4	230	1	3G3MV-CB002	—
		3/4	230	1	3G3MV-CB004	—
		1	230	1	3G3MV-CB007	—
		2	230	1	3G3MV-CB015	—
		3	230	1	3G3MV-CB022	—
		5	230	1	3G3MV-CB037	—
		1/8	230	3	3G3MV-C2001	—
		1/4	230	3	3G3MV-C2002	V7CU-20P2-N4
		3/4	230	3	3G3MV-C2004	V7CU-20P4-N4
		1	230	3	3G3MV-C2007	V7CU-20P7-N4
		2	230	3	3G3MV-C2015	V7CU-21P5-N4
		3	230	3	3G3MV-C2022	V7CU-22P2-N4
		5	230	3	3G3MV-C2037	V7CU-23P7-N4
		7 1/2	230	3	3G3MV-C2055	V7CU-25P5-N4
		10	230	3	3G3MV-C2075	V7CU-27P5-N4
		1/2	460	3	3G3MV-C4002	V7CU-40P2-N4
		1	460	3	3G3MV-C4004	V7CU-40P4-N4
		2	460	3	3G3MV-C4007	V7CU-40P7-N4
		3	460	3	3G3MV-C4015	V7CU-41P5-N4
3 1/2	460	3	3G3MV-C4022	V7CU-42P2-N4		
5	460	3	3G3MV-C4037	V7CU-43P7-N4		
10	460	3	3G3MV-C4055	V7CU-45P5-N4		
12 1/2	460	3	3G3MV-C4075	V7CU-47P5-N4		

Accessories

Item	Description	Model	
Inverter PLC	Advanced PLC with 6 inputs/4 outputs; built-in real-time clock/calendar and encoder interface; RS-422/485 and RS-232C serial communications	3G3MV-P10CDT3-E	
	Standard PLC with 6 inputs/4 outputs, encoder interface and RS-232C serial communications	3G3MV-P10CDT-E	
DeviceNet unit	DeviceNet slave unit; permits a PLC to monitor Run/Stop and operating conditions and make changes in set values. Remote I/O and message communications can be used simultaneously between the PLC and 3G3MV inverter.	3G3MV-PDRT2	
DIN rail mounting bracket	Single-phase, 230 VAC	3G3MV-□B001/-□B002/-□B004	3G3IV-PEZZ08122A
		3G3MV-□B007/-□B015	3G3IV-PEZZ08122B
		3G3MV-□B022	3G3IV-PEZZ08122C
		3G3MV-□B037	3G3IV-PEZZ08122D
	3-phase, 230 VAC	3G3MV-□2001/-□2002/-□2004/-□2007	3G3IV-PEZZ08122A
		3G3MV-□2015/-□2022	3G3IV-PEZZ08122B
		3G3MV-□2037	3G3IV-PEZZ08122C
	3-phase, 460 VAC	3G3MV-□4002/-□4004/-□4007/-□4015/-□4022	3G3IV-PEZZ08122B
		3G3MV-□4037	3G3IV-PEZZ08122C

Support Software and Programming Devices

Item	Description	Model
CX-Drive	Windows®-based programming software for setup; uploads and downloads parameters and monitoring	Included in CX-ONE
CX-Programmer	Sets up and monitors PLC operations	Included in CX-ONE

Manuals

Item	Description	Model
User's manual	3G3MV Series Multi-function Compact Inverter User Manual	I527-E3-2
DeviceNet unit	3G3MV-PDRT2 DeviceNet Communications Unit Operation Manual	I539-E1-2

Inverters G5+

Quick Link
G089

Flux Vector Inverter 600V Constant Torque for Machine Automation

The G5+ Inverter offers ultra-fast processing. All systems are controlled by a 32-bit, 20 MHz RISC processor, which executes basic instructions in one clock cycle. The processor uses an innovative "5 stage pipeline architecture" which allows the processor to perform 5 instructions at one time. This results in a rating of 16 MIPS (Million Instructions Per Second).

- The control board is common to all chassis inverter sizes
- Field upgradeable Flash ROM
- Four programmable control modes to suit any specific application.
- Built-in motor auto-tuning for easy start-up
- 2 sets of motor constants — very useful in machine tools applications
- 2 Line x 16 characters alphanumeric operator makes programming easier to understand
- Dedicated Serial Communication Port allows to network the G5+ with other devices
- PID function with feedback loop
- Energy savings software helps reduce power consumption
- Customized CASE software for specific applications



Canada Only



Specifications

Power supply	
Rated input voltage & frequency	3-phase, 500/575/600 VAC, 50/60Hz
Allowable voltage fluctuation	-15% of 500 VAC; +10% of 600 VAC
Allowable frequency fluctuation	±5%
Control characteristics	
Control method	Sine coded PWM (digital flux vector)
Starting torque	150% below 1 Hz (150% at 0 RPM with PG)
Speed control range	100:1 (1000:1 with PG)
Speed control accuracy	±0.2% (±0.02% with PG)
Speed response	5 Hz (30 Hz with PG)
Torque limit	Can be set by parameter: 4 steps available
Torque accuracy	±5%
Torque response	20 Hz (40 Hz with PG)
Frequency control range	0.1 to 400 Hz
Frequency accuracy	Digital Command: ±0.01%, +14° to 104°F (-10° to 40°C) Analog Command: ±0.1%, 77±18°F (25±10°C)
Frequency setting resolution	Digital Operator Reference: 0.01 Hz (12 bits) Analog Reference: 0.03 Hz/60 Hz (14 bits)
Output frequency resolution	0.01 Hz
Overload capacity	150% rated output current for one minute
Frequency setting signal	-10 to +10 V, 0 to +10 V, 4 to 20 mA
Accel/Decel	0.01 to 6000.0 seconds (Accel/Decel time setting independently; 4 steps available)
Braking torque	Approximately 20% (Approximately 125% when using braking resistor*) *Set I3-04=0 (Stall Prevention selection during decel is disabled) when connecting braking transistors or braking resistor.
Protective functions	
Motor overload protection	UL-recognized electronic thermal overload relay

Specifications (Continued)

Instantaneous overcurrent	Motor coasts to a stop at approximately 200% rated output current
Fuse protection	Motor coasts to a stop at blown fuse
Overload	Motor coasts to a stop after one minute at 150% rated output current
Overvoltage	Motor coasts to a stop if converter output voltage exceeds 1,050 VDC at 600 V input
Undervoltage	Motor coasts to a stop if converter output voltage drops to 546 VDC or below at 600 V input
Momentary power loss	Immediate stop after 15ms or longer power loss (setting mode before shipment)
Fin overheat	Thermostat
Stall prevention	Stall prevention during accel/decel and constant speed operation
Ground fault	Provided by electronic circuit (overcurrent level)
Power charge indication	Charge led stays ON until bus voltage drops below 50 VDC
Environmental conditions	
Location	Indoor (Protected from corrosive gases and dust)
Ambient temperature	+14 to 104°F (-10 to 40°C) for NEMA 1 type +14 to 113°F (-10 to 45°C) for Open Chassis Type
Storage temperature	-4 to 140°F (-20 to 60°C)
Humidity	95% RH (Non-condensing)
Elevation	1,000 m (3,281 feet) or below
Wiring distance	328 ft (100 m) or less between inverter and motor
Vibration	9.8 m/s ² (1G) less than 20 Hz, up to 1.96 m/s ² (0.2G) at 20 to 50 Hz
Other functions	
Input signals	3 Analog Inputs available (0 to 10 V, -10 to +10 V, 4 to 20 mA)
Multi-function inputs	8 Digital Inputs with 6 programmable for functions such as: 3 wire sequencing (2 wire is standard), multi-step speed operation, fault reset, external fault (NO or NC), jog, accel/decel time select, MOP function, speed search command, Local/Remote selection, motor 1 or 2 selection, PID disable, PID reset, trim increase or decrease, fast stop, analog signal selection, and many others
Output signals	2 Analog Outputs (0 to 10 V) with 25 different settable functions
Multi-function outputs	4 Digital Outputs (Form C fault contacts plus 3 programmable outputs [1 form A, 2 open collector]). Programmable Output functions available are: run signal, zero speed, frequency agree (2), frequency detection (4), torque level detection (2), timer output, at current/torque limit, regenerating, minor or major fault, DB overheat, loss of reference, and many others.
Standard functions	Settable for V/Hz, open loop vector, or closed loop vector, DC injection braking, PID control, zero servo mode, energy saving mode, 4 accel/decel times with S-curve, 8 preset speeds, slip and torque compensation, 3 jump frequencies, stall prevention, auto restart, and many other standard features.

Ordering Information

G5+ Inverter

Description	Enclosure	Rating	Model
Flux vector inverter with constant torque control	NEMA 1	2 HP, 3.5 A, 575 VAC	G5M-51P5-N1
		3 HP, 4.1 A, 575 VAC	G5M-52P2-N1
		5 HP, 6.3 A, 575 VAC	G5M-53P7-N1
		7.5 HP, 9.8A, 575 VAC	G5M-55P5-N1
		10 HP, 12.5 A, 575 VAC	G5M-57P5-N1
		15 HP, 17.0 A, 575 VAC	G5M-5011-N1
		20 HP, 22.0 A, 575 VAC	G5M-5015-N1
		25 HP, 27.0 A, 575 VAC	G5M-5018-N1
		30 HP, 32.0 A, 575 VAC	G5M-5022-N1
		40 HP, 41.0 A, 575 VAC	G5M-5030-N1
		50 HP, 52.0 A, 575 VAC	G5M-5037-N1
		60 HP, 62.0 A, 575 VAC	G5M-5045-N1
		75 HP, 77 A, 575 VAC	G5M-5055-N1
		100 HP, 99 A, 575 VAC	G5M-5075-N1
	Open chassis	120 HP, 130 A, 575 VAC	G5M-5090-N0
		150 HP, 172 A, 575 VAC	G5M-5110-N0
		200 HP, 200 A, 575 VAC	G5M-5160-N0

Support Software and Programming Devices

Item	Description	Model
CX-Drive	Windows®-based programming software for sets up Uploads and downloads parameters and monitoring	Included in CX-ONE

Manuals

Item	Description	Model
User's manual	G5+ User's manual	IM-G5

Inverters P5+

Quick Link
G089A

Powerful 600V Variable Torque Inverter for Building Automation

- Energy savings software helps reduce power consumption
- Built-in PID function allows feedback loop
- Highly programmable with 116 parameters
- UL listed electronic thermal overload that eliminates external devices
- Speed search function restarts a coasting motor without stopping it, after a power loss
- Multi-function Inputs (5) & Outputs (3) for increased flexibility
- 5 preset speeds (4 speeds + jog) allows multi-step operation
- Stall prevention/Current limit prevent overcurrent trips and motor stall
- Momentary power loss ride-through Continue the operation, after recovery from a momentary power loss
- Critical frequency lockouts (2) to avoid mechanical resonance (as in cooling towers)
- Alphanumeric digital operator makes programming easier to understand
- Communications cards for MetaSys N2, Apogee, and Echelon LONworks building automation protocols. Use optional communication card Modbus RTU to control up to 31 Drives
- Common control board across all models
- 3rd generation IGBT output section
- Terminals for optional DC link reactor (from 2HP / 600V up to 20 HP / 600V)
- Built-in braking IGBT (from 2HP / 600V up to 30 HP / 600V)
- Built-in RS-232C port for direct connection to programming tools



Canada Only



Specifications

Power Supply	
600V rated input voltage & frequency	3-phase, 500/575/600 VAC, 50/60 Hz
Allowable voltage fluctuation	-15% of 500 VAC, +10% of 600 VAC
Allowable frequency fluctuation	±5%
Control Characteristics	
Control method	Sine Wave PWM
Frequency control range	0.1 to 400 Hz
Frequency accuracy	Digital Operator Reference: 0.01% Analog Reference: 0.1%
Frequency setting resolution	Digital Operator Reference: 0.01 Hz Analog Reference: 0.06 Hz/60 Hz
Output frequency resolution	0.01 Hz
Overload capacity	120% rated output current for one minute (150% for constant torque rating)
Frequency setting signal	0 to +10 V (20 kΩ), 4 to 20 mA (250 Ω)
Accel/Decel	0.01 to 3600.0 sec (Accel/Decel time setting independently; 0.1sec)
Braking torque	Approximately 20%
Protective Functions	
Motor overload protection	UL recognized internal electronic thermal overload relay (I ² t)

Specifications (Continued)

Instantaneous overcurrent	Motor coasts to a stop at approximately 180% rated output current
Fuse protection	Motor coasts to a stop at blown fuse
Overload	Motor coasts to a stop after one minute at 120% rated output current (150% for constant torque)
Overvoltage	Motor coasts to a stop if converter output exceeds 1,050 VDC at 600 VAC input
Undervoltage	Motor coasts to a stop if converter output voltage drops below 546 VDC
Momentary power loss	Immediate stop after 15 ms or longer power loss (Continuous system operation during power loss less than 2 seconds is equipped as standard)
Fin overheat	Thermistor – OH1, OH2
Stall prevention	Stall prevention during accel/decel and constant speed operation
Ground fault	Provided by electronic circuit
Power charge indication	Charge LED stays on until bus voltage drops below 50 VDC
Environmental Conditions	
Location	Indoor (Protected from corrosive gases and dust)
Ambient temperature	+14 to 104°F (-10 to 40°C) for NEMA 1 type (not frozen) +14 to 113° F (-10 to 45° C) for Open Chassis type
Storage temperature	-4 to 140°F (-20 to 60°C)
Humidity	95% RH (non-condensing)
Elevation	1000 m (3281 feet) or below
Vibration	9.8 m/s ² (1G) less than 20 Hz, up to 1.96 m/s ² (0.2G) at 20 to 50 Hz
Wiring distance	328 ft (100 m) or less between inverter and motor
Other Functions	
Analog inputs	2 analog inputs available (0-10 V, 4-20 mA)
Multi-function digital inputs	6 Digital Inputs with 5 programmable for functions such as: 3 wire sequencing (2 wire is standard), multi-step speed operation, fault reset, external fault (NO or NC), jog, accel/decel time select, speed search command, Local/Remote selection, PID disable, PID reset, fast stop, serial communication select, timer start, parameter lockout, and many others.
Analog outputs	1 Analog Output (0-10 V) settable as output frequency, output current, output KW, or DC bus voltage.
Multi-function digital outputs	2 Programmable Digital Outputs (1 form C and 1 form A), Programmable functions available are: run signal, fault, at speed, frequency detection (2), overtorque detection (NO or NC), timer output, loss of reference or PID feedback, and many others.
Standard functions	DC injection braking, PID control, Energy Saving mode, 2 accel/decel times with S-curve, 4 preset speeds, selectable for constant or variable torque, 2 jump frequencies, stall prevention, auto restart, power-loss ride through, and many other standard features.

Ordering Information

P5+ Inverter

Description	Enclosure	Rating	Model
Variable torque inverter	NEMA 1	2 to 3 HP, 3.9 A, 600 VAC	P5M-51P5-N1
		5.0 HP, 7.0 A, 600 VAC	P5M-53P7-N1
		7.5/10 HP, 11 A, 600 VAC	P5M-55P5-N1
		15 HP, 19 A, 600 VAC	P5M-5011-N1
		20 HP, 25 A, 600 VAC	P5M-5015-N1
		25 HP, 30 A, 600 VAC	P5M-5018-N1
		30 HP, 36 A, 600 VAC	P5M-5022-N1
		40 HP, 46 A, 600 VAC	P5M-5030-N1
		50 HP, 58 A, 600 VAC	P5M-5037-N1
		60 HP, 69 A, 600 VAC	P5M-5045-N1
		75 HP, 86 A, 600 VAC	P5M-5055-N1
		100 HP, 111 A, 600 VAC	P5M-5075-N1
		Open chassis	125/150 HP, 145 A, 600 VAC
		200 HP, 192 A, 600 VAC	P5M-5110-N0

Manuals

Item	Description	Model
User's manual	User's manual	IM-P5

Inverters

RV

Quick Link

A036

Flux Vector Inverter for General-Purpose & High-End Applications

- Wide range of sizes available in 230 VAC and 460 VAC, from ½ to 150 HP in 230 VAC and ¼ to 500 HP in 460 VAC. It is UL, cUL and CE compliant
- Volts/Hertz setting for simple applications and open or closed loop vector control for advanced applications satisfy most motor control needs
- Built-in functions like PID parameter calculation, Energy savings, Configurable digital and analog I/O, Over-current tripping protection ensures uninterrupted operation, DC Bus choke above 30 HP, and 12 pulse rectification standard above 50 HP (100 HP at 460 V)
- New static auto-tune function that eliminates the need for motor rotation to determine and set parameters
- High-slip braking function for intermittent braking applications shortens motor stopping time by one-third without using braking resistors
- Broad Network Communications available like a built-in RS-485/422 Modbus communications protocol and made available optional cards for DeviceNet (3G3RV-PDRT2), Modbus Plus (CM071), Ethernet Modbus TCP/IP (CM090), LONWorks (CM048) and Profibus-DP (CM061)



Canada Only

- High reliability with an MTBF of 28 years
- Easy to maintain and inspect the cooling fan with detachable fan design and life-prolonging automatic fan shutoff; split cover panel allows safe access to control terminals
- Quick inverter setup simplified through a quick program mode and the standard keypad doubles as a copy unit to set multiple drives
- Removable terminal strip eliminates the need to re-wire the drive
- Integrate a PLC into 3G3RV inverters with 6 input/4 output points, clock/calendar and encoder interface built in
- All RV models have a unique, low-carrier PWM control to suppress audible noise

Specifications

Inverters

Control characteristics	
Control method	Sine wave PWM; Closed loop flux vector, Open loop vector control, V/f control, V/f with PG control (switched by parameter setting)
Speed control range	100:1 (1000:1 with PG)
Speed control accuracy	±0.2% (25°C ±10°C) (±0.02% with PG)
Speed control response	5 Hz (30 Hz with PG)
Torque characteristics	Heavy duty/CT selected (low carrier, fixed torque applications): 150% /0.5 Hz (Open or closed loop vector control) Normal duty/VT selected (high carrier, variable torque applications): 120%/0.5 Hz
Frequency control range	0.01 to 300 Hz (CT selected.), 0.01 to 400 Hz (VT selected.)
Frequency accuracy (temperature characteristics)	Digital references: ±0.01% (-10°C to +40°C) Analog references: ±0.1% (25°C ±10°C)
Frequency setting resolution	Digital references: 0.01 Hz Analog references: 0.03 Hz/60 Hz (10 bit with sign)
Output frequency resolution	0.001 Hz
Overload capacity and maximum current	Heavy duty/CT selected: 150% of rated output current per minute Normal duty/VT selected: Approximately 110% of rated output current per minute
Frequency setting signal	Voltage input of 0 to ±10 or 0 to 10 (20 kΩ) VDC or current input of 4 to 20 mA
Acceleration/deceleration time	0.01 to 6000.0 s (4 selectable combinations of independent acceleration and deceleration settings)
Braking torque	Approximately 20% (Approximately 125% with Braking Resistor option) (100% + with High Slip Braking)
Main control functions	Auto restart after momentary power loss, speed searches, overtorque detection, torque limits, 16-speed control (maximum), acceleration/deceleration time changes, S-curve acceleration/deceleration, 2-wire or 3-wire sequence, auto-tuning (rotational or stationary), dwell functions, cooling fan ON/OFF control, slip compensation, torque compensation, jump frequencies, upper and lower frequency limits, DC injection braking for starting and stopping, high-slip braking, PID control (with sleep function), energy saving control, RS-485/422A communications (Conforms to Modbus, 19.2 kbps maximum), fault reset, and function copying

Protective functions	
Motor protection	UL recognized protection by electronic thermal overload relay (² t).
Overcurrent protection	Instantaneous protection. Stops at approximately 200% of rated output current.
Overload protection	Heavy duty/CT selected (low carrier, fixed torque applications): 150% of rated output current per minute (not for 110 kW) Normal duty/VT selected (high carrier, variable torque applications): Approximately 110% of rated output current per minute
Overvoltage protection	200 Class Inverter: Stops when main-circuit DC voltage is above 410 VDC. 400 Class Inverter: Stops when main-circuit DC voltage is above 820 VDC.
Undervoltage protection	200 Class Inverter: Stops when main-circuit DC voltage is below 190 VDC. 400 Class Inverter: Stops when main-circuit DC voltage is below 380 VDC.
Momentary power loss ride-through	Stops for 15 ms or more. By selecting the momentary power loss method, operation can be continued if power is restored within 2 s.
Cooling fin overheating	Protection by thermistor
Grounding protection	Protection by electronic circuits. (Overcurrent level)
Charge indicator	Lit when the main circuit DC voltage is approximately 50 V or more.
Environmental conditions	
Application site	Indoor (no corrosive gas, dust, etc.)
Ambient operating temperature	-10°C to 40°C (Closed wall-mounted type) / 10°C to 45°C (Open chassis type)
Storage temperature	-20°C to + 60°C (short-term temperature during transportation)
Ambient operating humidity	95% max. (with no condensation)
Altitude	3300 ft (1000 m) max.
Vibration	10 to 20 Hz, 9.8 m/s ² max.; 20 to 50 Hz, 2 m/s ² max, oscillation vibration of 20 Hz
Protective enclosure	Enclosed, wall-mounting (NEMA1: Equivalent to IP20) or Mounted in a panel (equivalent to IP00)

Inverter PLC

Model	3G3RV-P10ST8-E
Type	Embedded board PLC, installs inside 3G3RV inverters
I/O points	6 input points, 4 output points on the PLC board 256 I/O by using CompoBus/S distributed network
Clock/calendar	Yes
Encoder interface	Yes
Connectivity	Peripheral port Serial ports: RS-232C, RS-422/485 CompoBus/S master DeviceNet slave
Software	CX-Programmer included in CX-One

Ordering Information

RV Inverter

Description	Enclosure	Rating	Model	
Flux vector inverter with selectable constant torque and variable torque	NEMA 1	0.5 HP 3.2 A, 230 VAC	RV-A2004	
		1.0 HP 4.1 A, 230 VAC	RV-A2007	
		2 HP 7 A, 230 VAC	RV-A2015	
		3 HP 9.6 A, 230 VAC	RV-A2022	
		5 HP 15 A, 230 VAC	RV-A2037	
		7.5 HP 23 A, 230 VAC	RV-A2055	
		10 HP 31 A, 230 VAC	RV-A2075	
		15 HP 45 A, 230 VAC	RV-A2110	
		20 HP 58 A, 230 VAC	RV-A2150	
		25 HP 71 A, 230 VAC	RV-A2185	
		30 HP 85 A, 230 VAC	RV-A2220	
		40 HP 115 A, 230 VAC	RV-A2300	
		Open chassis	50 HP 145 A, 230 VAC	RV-B2370
			60 HP 180 A, 230 VAC	RV-B2450
	75 HP 215 A, 230 VAC		RV-B2550	
	100 HP 283 A, 230 VAC		RV-B2750	
	125 HP 346 A, 230 VAC		RV-B2900	
	150 HP 415 A, 230 VAC		RV-B211K	

RV Inverter (Continued)

Description	Enclosure	Rating	Model
Flux vector inverter with selectable constant torque and variable torque (cont'd)	NEMA 1	¾ HP 1.8 A, 460 VAC	RV-A4004
		1 HP 2.1 A, 460 VAC	RV-A4007
		2 HP 3.7 A, 460 VAC	RV-A4015
		3 HP 5.3 A, 460 VAC	RV-A4022
		5 HP 7.6 A, 460 VAC	RV-A4037
		7.5 HP 12.5 A, 460 VAC	RV-A4055
		10 HP 17 A, 460 VAC	RV-A4075
		15 HP 24 A, 460 VAC	RV-A4110
		20 HP 31 A, 460 VAC	RV-A4150
		25 HP 39 A, 460 VAC	RV-A4185
		30 HP 45 A, 460 VAC	RV-A4220
		40 HP 60 A, 460 VAC	RV-A4300
		50 HP 75 A, 460 VAC	RV-A4370
		60 HP 91 A, 460 VAC	RV-A4450
	75 HP 112 A, 460 VAC	RV-A4550	
	Open chassis	100 HP 150 A, 460 VAC	RV-B4750
		150 HP 180 A, 460 VAC	RV-B4900
		200 HP 260 A, 460 VAC	RV-B413K
		250 HP 304 A, 460 VAC	RV-B416K
		300 HP 370 A, 460 VAC	RV-B418K
		400 HP 506 A, 460 VAC	RV-B422K
			500 HP 675 A, 460 VAC

Accessories

Item	Description	Model
Inverter PLC	Embedded PLC board with 6 inputs/4 outputs; built-in clock/calendar and encoder interface; CompoBus/S master and DeviceNet slave network capabilities	3G3RV-P10ST8-E
DeviceNet unit	DeviceNet slave unit; permits a PLC to monitor Run/Stop and operating conditions and make changes in set values. Remote I/O and message communications can be used simultaneously between the PLC and 3G3RV inverter	3G3RV-PDRT2

Support Software and Programming Devices

Item	Description	Model
CX-Drive	Windows®-based programming software for sets up Uploads and downloads parameters and monitoring	Included in CX-ONE

Manuals

Item	Description	Model
User's manual	3G3RV Series Multi-function Compact Inverter User Manual	I540-E3-02
DeviceNet unit	3G3□V-PDRT2 DeviceNet Communications Unit Operation Manual	I539-E1-02

Position Controllers

CJ1/CS1-NC/-CT/-HC

PLC-Based Accurate Positioning Control

From simple position measurement to multi-axis synchronized control, Omron offers a full range of PLC-based solutions:

- High-Speed Counter modules gather position information from SSI or incremental encoders. Actual positions are compared with internally started target values.
- Position Control modules are used for point-to-point positioning with servo drives or stepper motors. Target data and acceleration/deceleration curves can be adjusted on-the-fly.
- Position control modules equipped with MECHATROLINK-II interface can control multiple drives through a single, high-speed data link. Message routing through multiple communication layers allows the attached drives to be configured from any point in the control network.

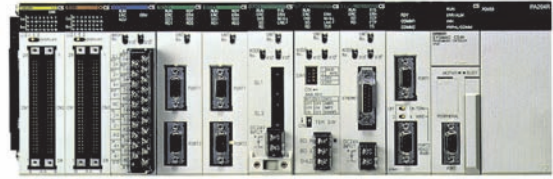

MECHATROLINK-II is a registered trademark of Yaskawa Corporation.

Ordering Information

CS1 Series

Modules are counted as Special I/O and occupy one rack slot.

Channels /axes	Type	Signal type	Current consumption	Remarks	Servo series	Connection type	Model
2	SSI inputs (absolute position data)	Synchronous Serial Protocol	320 mA	Baud rate, encoding type, data length, etc. can be set per channel	—	M3 screw	CS1W-CTS21
2	500 kHz counter	Line driver, 24 V	360 mA	Configurable digital inputs + outputs; target values trigger interrupt to CPU	—	1 x 40 pt (Fujitsu)	CS1W-CT021
4			450 mA		—	2 x 40 (MIL-spec)	CS1W-CT041
1	Position controller	Open collector, 24 V	250 mA	500 kpps pulse outputs; inputs for origin, limit switches, stop, interrupt Use CX-Position software	WT-Series U-Series SmartStep	1 x 40 pt (Fujitsu)	CS1W-NC113
2			250 mA		WT-Series U-Series SmartStep	1 x 40 pt (Fujitsu)	CS1W-NC213
4			360 mA		WT-Series U-Series SmartStep	2 x 40 pt (Fujitsu)	CS1W-NC413
1	Position controller	Line driver	250 mA		WT-Series U-Series SmartStep	1 x 40 pt (Fujitsu)	CS1W-NC133
2			250 mA		WT-Series U-Series SmartStep	1 x 40 pt (Fujitsu)	CS1W-NC233
4			360 mA		WT-Series U-Series SmartStep	2 x 40 pt (Fujitsu)	CS1W-NC433
16	Position controller	MECHATROLINK-II	360 mA	Position, speed and torque control; access to all drive parameters Use CX-Motion NCF	WN-Series ML2	Mechatro-Link-II	CS1W-NCF71

Servo Relay Unit Connection Compatibility with CS1 Position Control Modules

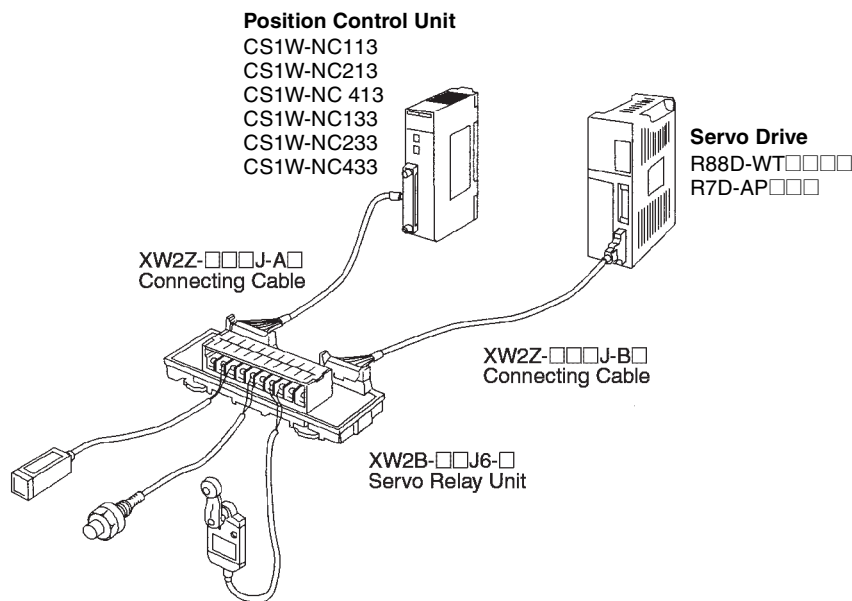

Position control unit (PCU)	Cable between PCU and servo relay unit	Servo relay unit	Cable between servo relay unit and servo driver	Servo driver
CS1W-NC113	XW2Z-050J-A6 (0.5 m) XW2Z-100J-A6 (1 m)	XW2B-20J6-1B	XW2Z-100J-B4 (1 m) XW2Z-200J-B4 (2 m)	R88D-WT□□□□
	XW2Z-050J-A8 (0.5 m) XW2Z-100J-A8 (1 m)	XW2B-20J6-1B	XW2Z-100J-B5 (1 m) XW2Z-200J-B5 (2 m)	R7D-AP□□□□
CS1W-NC213 CS1W-NC413	XW2Z-050J-A7 (0.5 m) XW2Z-100J-A7 (1 m)	XW2B-40J6-2B	XW2Z-100J-B4 (1 m) XW2Z-200J-B4 (2 m)	R88D-WT□□□□
		XW2B-40J6-4A	XW2Z-100J-B8 (1 m) XW2Z-200J-B8 (2 m)	R88D-WT□□□□ when using RS-422
	XW2Z-050J-A9 (0.5 m) XW2Z-100J-A9 (1 m)	XW2B-40J6-2B	XW2Z-100J-B5 (1 m) XW2Z-200J-B5 (2 m)	R7D-AP□□□□
		XW2B-40J6-4A	XW2Z-100J-B7 (1 m) XW2Z-200J-B7 (2 m)	R7D-AP□□□□ when using RS-422
CS1W-NC133	XW2Z-050J-A10 (0.5 m) XW2Z-100J-A10 (1 m) XW2Z-050J-A12 (0.5 m) XW2Z-100J-A12 (1 m)	XW2B-20J6-1B	XW2Z-100J-B4 (1 m) XW2Z-200J-B4 (2 m)	R88D-WT□□□□
		XW2B-20J6-1B	XW2Z-100J-B5 (1 m) XW2Z-200J-B5 (2 m)	R7D-AP□□□□
CS1W-NC233 CS1W-NC433	XW2Z-050J-A11 (0.5 m) XW2Z-100J-A11 (1 m)	XW2B-40J6-2B	XW2Z-100J-B4 (1 m) XW2Z-200J-B4 (2 m)	R88D-WT□□□□
		XW2B-40J6-4A	XW2Z-100J-B8 (1 m) XW2Z-200J-B8 (2 m)	R88D-WT□□□□ when using RS-422
	XW2Z-050J-A13 (0.5 m) XW2Z-100J-A13 (1 m)	XW2B-40J6-2B	XW2Z-100J-B5 (1 m) XW2Z-200J-B5 (2 m)	R7D-AP□□□□
		XW2B-40J6-4A	XW2Z-100J-B7 (1 m) XW2Z-200J-B7 (2 m)	R7D-AP□□□□ when using RS-422
CS1W-HCP22-V1	XW2Z-050J-A29 (0.5 m) XW2Z-050J-A32 (0.5 m) XW2Z-100J-A29 (1 m) XW2Z-100J-A32 (1 m)	XW2B-80J7-1A	XW2Z-100J-B11 (1 m) XW2Z-200J-B11 (2 m)	R88D-WT□□□□
			XW2Z-100J-B12 (1 m) XW2Z-200J-B12 (2 m)	R7D-AP□□□□

CJ1 Series

Modules are counted as Special I/O, except 16-point CJ1W-NCF71, which is a CPU bus module.

Channels/axes	Type	Signal type	Current consumption	Remarks	Servo series	Connection type	Model
2	SSI inputs (absolute position data)	Synchronous Serial Protocol	300 mA	Baud rate, encoding type, data length, etc. can be set per channel	—	M3 screw	CJ1W-CTS21-E
2	500 kHz counter	Line driver, 24 V	280 mA	Configurable digital inputs + outputs;	—	1 x 40 pt (Fujitsu)	CJ1W-CT021
4	100 kHz counter	Line driver, 24 V via terminal block	320 mA	Target values trigger interrupt to CPU	—	1 x 40 (MIL-spec)	CJ1W-CTL41-E
1	Position controller	Open collector, 24 V	250 mA	500 kpps pulse outputs; inputs for origin, limit switches, stop, interrupt Use CX-Position software	WT-Series U-Series SmartStep	1 x 40 pt (Fujitsu)	CJ1W-NC113
2			250 mA		WT-Series U-Series SmartStep	1 x 40 pt (Fujitsu)	CJ1W-NC213
4			360 mA		WT-Series U-Series SmartStep	2 x 40 pt (Fujitsu)	CJ1W-NC413
1	Position controller	Line driver	250 mA	500 kpps pulse outputs; inputs for origin, limit switches, stop, interrupt Use CX-Position software	WT-Series U-Series SmartStep	1 x 40 pt (Fujitsu)	CJ1W-NC133
2			250 mA		WT-Series U-Series SmartStep	1 x 40 pt (Fujitsu)	CJ1W-NC233
4			360 mA		WT-Series U-Series SmartStep	2 x 40 pt (Fujitsu)	CJ1W-NC433
16	Position controller	Mechatro-Link-II	360 mA	Position, speed and torque control; access to all drive parameters Use CX-Motion NCF	WN-Series ML2	Mechatro-Link-II	CJ1W-NCF71

Servo Relay Unit Connection Compatibility with CJ1 Position Control Modules

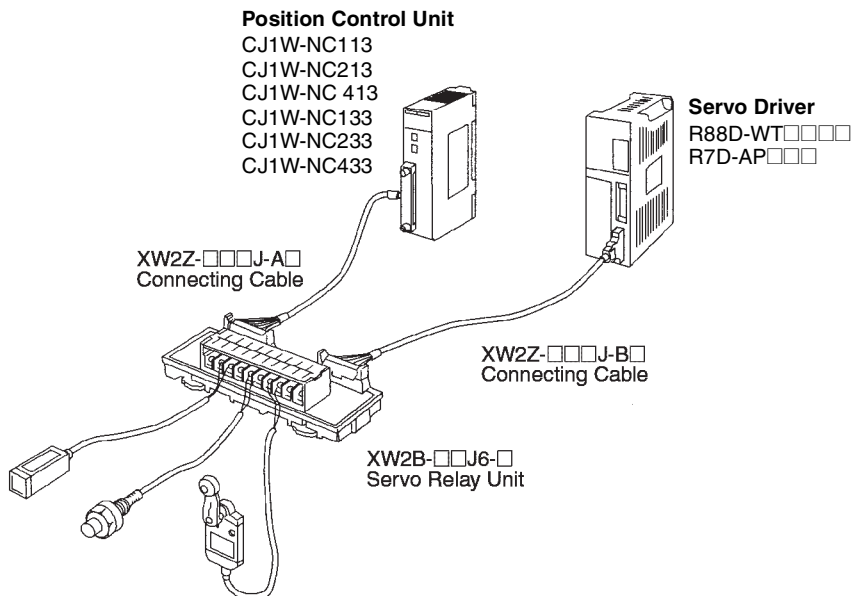

Position control unit (PCU)	Cable between PCU and servo relay unit	Servo relay unit	Cable between servo relay unit and servo driver	Servo driver
CJ1W-NC113	XW2Z-050J-A14 (0.5 m) XW2Z-100J-A14 (1 m)	XW2B-20J6-1B	XW2Z-100J-B4 (1 m) XW2Z-200J-B4 (2 m)	R88D-WT□□□□
	XW2Z-050J-A16 (0.5 m) XW2Z-100J-A16 (1 m)	XW2B-20J6-1B	XW2Z-100J-B5 (1 m) XW2Z-200J-B5 (2 m)	R7D-AP□□□
CJ1W-NC213 CJ1W-NC413	XW2Z-050J-A15 (0.5 m) XW2Z-100J-A15 (1 m)	XW2B-40J6-2B	XW2Z-100J-B4 (1 m) XW2Z-200J-B4 (2 m)	R88D-WT□□□□
		XW2B-40J6-4A	XW2Z-100J-B8 (1 m) XW2Z-200J-B8 (2 m)	R88D-WT□□□□ when using RS-422
	XW2Z-050J-A17 (0.5 m) XW2Z-100J-A17 (1 m)	XW2B-40J6-2B	XW2Z-100J-B5 (1 m) XW2Z-200J-B5 (2 m)	R7D-AP□□□
		XW2B-40J6-4A	XW2Z-100J-B7 (1 m) XW2Z-200J-B7 (2 m)	R7D-AP□□□ when using RS-422
CJ1W-NC133	XW2Z-050J-A18 (0.5 m) XW2Z-100J-A18 (1 m)	XW2B-20J6-1B	XW2Z-100J-B4 (1 m) XW2Z-200J-B4 (2 m)	R88D-WT□□□□
		XW2B-20J6-1B	XW2Z-100J-B5 (1 m) XW2Z-200J-B5 (2 m)	R7D-AP□□□
CJ1W-NC233 CJ1W-NC433	XW2Z-050J-A19 (0.5 m) XW2Z-100J-A19 (1 m)	XW2B-40J6-2B	XW2Z-100J-B4 (1 m) XW2Z-200J-B4 (2 m)	R88D-WT□□□□
		XW2B-40J6-4A	XW2Z-100J-B8 (1 m) XW2Z-200J-B8 (2 m)	R88D-WT□□□□ when using RS-422
	XW2Z-050J-A21 (0.5 m) XW2Z-100J-A21 (1 m)	XW2B-40J6-2B	XW2Z-100J-B5 (1 m) XW2Z-200J-B5 (2 m)	R7D-AP□□□
		XW2B-40J6-4A	XW2Z-100J-B7 (1 m) XW2Z-200J-B7 (2 m)	R7D-AP□□□ when using RS-422

Software Documentation

Description	Specification	Model
CX-Position support software	Included in CX-ONE	Manual W433
CX-Motion NCF support software	Included in CX-ONE	Manual W436

Motion Controllers CJ1/CS1-MC

High-Speed PLC-Based Motion Controllers

Motion control modules for CJ1 and CS1 PLC series are equipped with MECHATROLINK-II interface that can control multiple drives through a single, high-speed data link. Message routing through multiple communication layers allows the attached drives to be configured from any point in the control network.

- PLC-based motion controller eliminates integration of motion controllers from other suppliers
- Complete digital control of drives via MECHATROLINK-II replaces SERCOS programming
- Controls a total of 32 axes (30 physical max.)
- Simplified wiring saves design time and installation and maintenance costs
- Real multi-tasking and parallel programming
- Simple to develop and modify motion programs using BASIC
- Access to the complete system from one point allows quick troubleshooting and effective time management
- Linear, circular, and helical interpolation for accurate positioning
- Electronic axes synchronization produces smooth motion
- Electronic cam profiles simulates popular mechanical ones to shorten setup
- Dedicated inputs/outputs on the controller
- All features of the W-Series servos are available

MECHATROLINK-II is a registered trademark of Yaskawa Corporation.



MECHATROLINK-II High-Speed Motion Link

This high-speed interface replaces the costly discrete wiring required with traditional systems. Just one MECHATROLINK-II cable eliminates the need for about 15 to 18 wires for each axis, simplifying wiring, and reducing installation costs and time. It also means that maintenance and troubleshooting are minimized. With a baud rate of up to 10 MHz, the MECHATROLINK-II link provides communication cycle times of 0.5 ms for 4 axes, to 4 ms for 30 axes, ensuring fast, precise motion control.

Ordering Information

CJ1/CS1 Motion Controllers

Type	Axes	Output type	Rating	Servo series	PLC series	Current consumption	Model
Motion control module	2 axes	Analog	Uses G language Uses CX-Motion software	WT-Series U-Series	CS1	0.60 A (w/ Teaching Box: 0.80)	CS1W-MC221-V1
	4 axes	Analog	Uses G language Uses CX-Motion software	WT-Series U-Series	CS1	0.70 A (w/ Teaching Box: 1.00)	CS1W-MC421-V1
	30 axes	MECHATROLINK-II	Uses CX-Motion MCH software; MECHATROLINK-II high-speed bus provides instant communications between the motion controller and Omron's W-Series servo drives Functions: Electronic cam profiles and axis synchronization; Registration inputs; accesses all drive parameters; gear functions	WN-Series ML2	CS1	0.8 A, 5 VDC (counts as CPU bus unit)	CS1W-MCH71
				WN-Series ML2	CJ1-H/ CJ1M	0.6 A, 5 VDC (counts as CPU bus unit)	CJ1W-MCH71

Servo Driver Connection Cables to Motion Control Modules

Motion Control Unit (MCU)	Control axes	Terminal block model	I/O Cable model (between Terminal Block and MCU)	Servo driver
CS1W-MC221	2	XW2B-20J6-6	XW2Z-100J-F1 (1 m)	R88D-W
CS1W-MC421	4	XW2B-40J6-7	XW2Z-100J-F1 (1 m)	

Cables Between Motion Control Unit and Servo Driver

Servo driver	Cable length	Cable between MCU and Servo Driver	
		1 axis model	2-axis model
R88D-W	1 m	R88A-CPW001M1	R88A-CPW001M2
	2 m	R88A-CPW002M1	R88A-CPW002M2
	3 m	R88A-CPW003M1	R88A-CPW003M2
	5 m	R88A-CPW005M1	R88A-CPW005M2

MECHATROLINK-II Accessories and Cables

Motion Control Unit	Description	Specification	Model	
CJ1W-MCH71 CS1W-MCH71	MECHATROLINK-II Interface Unit	For W-Series servo drivers	FNY-NS115	
	24 VDC I/O Module	64 inputs/64 outputs	FNY-IO2310	
	Counter Module	2-channel reversible counter	FNY-PL2900	
	Pulse Output Module	For pulse positioning	FNY-PL2910	
	Cables for W-Series with USB connectors and ring core	0.5 m		FNY-W6003-A5
		1 m		FNY-W6003-01
		3 m		FNY-W6003-03
		5 m		FNY-W6003-05
		10 m		FNY-W6003-10
		20 m		FNY-W6003-20
		30 m		FNY-W6003-30
	Terminating resistor for MECHATROLINK-II	—		FNY-W6022
	Repeater for MECHATROLINK-II	—		FNY-REP2000
CX-Motion MCH support software			Included in CX-ONE	
CX-Motion support software			Included in CX-ONE	

Soft Starters

G3JA

Quick Link
R002

3-Phase Hybrid Soft Starters Extend Motor Life

- G3JA-D Current Limit Starter for 3-phase, 6-lead motors provides internal Star-delta control and simplifies wiring. Star-delta and protective functions are included in this single unit
- G3JA-C Soft Start, Kick Start, Current Limit Start, and Soft Stop functions for 3-phase inductive motors satisfy motor performance needs for a wide range of applications. Internal protections include protection against overload and phase loss
- Smooth motor starts and stops can reduce mechanical shock, leading to longer motor life, less frequent servicing and lower maintenance costs
- Reduced power loss through hybrid control: Power supplied through a thyristor during starting or stopping and through a bypass relay during stable operation
- Slim 45-mm body saves installation space; all models have the same shape



- Electronic Thermal Overload Relay built in protects the motor from problems such as burning due to motor overload or locking. The overload class can be set to OFF, 10, 15, or 20
- Optional Auxiliary Contact Block enhances operation monitoring by providing an output of operating status
- Meets UL508; cULus listed; complies with IEC standards, etc.

Soft Starters Ordering Information

Current Limit Starters

Supply voltage	Main circuit operating current (A)		Lamp load (kW)			HP			Model
	Current rating	Adjustable range	200 VAC 50/60 Hz	230 VAC 50 Hz	380/400/415 VAC 50 Hz	200 VAC 60 Hz	230 VAC 60 Hz	460 VAC 60 Hz	
100 to 240 VAC, 50/60 Hz	3	1 to 3	0.2 to 0.4	0.55	1.1	0.5	0.5	0.5 to 1.5	G3JA-D403B AC100-240
	9	3 to 9	0.55 to 1.5	2.2	4	0.75 to 2	0.75 to 2	1.5 to 5	G3JA-D409B AC100-240
	16	5.3 to 16	1.1 to 2.2	4	7.5	1.5 to 3	1.5 to 5	5 to 10	G3JA-D416B AC100-240
	20	6.7 to 20	1.5 to 3.7	5.5	7.5	2 to 5	2 to 5	5 to 10	G3JA-D420B AC100-240
	25	9.2 to 27.7	2.2 to 5.5	5.5	11	3 to 7.5	3 to 7.5	7.5 to 15	G3JA-D425B AC100-240
	32	10.9 to 32.9	3.7 to 7.5	7.5	15	3 to 10	5 to 10	7.5 to 20	G3JA-D432B AC100-240
	51	17.3 to 51.9	5.5 to 11	15	22	5 to 15	7.5 to 15	15 to 30	G3JA-D451B AC100-240
	64	21.3 to 64	5.5 to 15	18.5	30	7.5 to 20	7.5 to 20	20 to 40	G3JA-D464B AC100-240

Current Limit Starters (Continued)

Supply voltage	Main circuit operating current (A)		Lamp load (kW)			HP			Model
	Current rating	Adjustable range	200 VAC 50/60 Hz	230 VAC 50 Hz	380/400/415 VAC 50 Hz	200 VAC 60 Hz	230 VAC 60 Hz	460 VAC 60 Hz	
24 VAC/ VDC	3	1 to 3	0.2 to 0.4	0.55	1.1	0.5	0.5	0.5 to 1.5	G3JA-D403B AC/DC24
	9	3 to 9	0.55 to 1.5	2.2	4	0.75 to 2	0.75 to 2	1.5 to 5	G3JA-D409B AC/DC24
	16	5.3 to 16	1.1 to 2.2	4	7.5	1.5 to 3	1.5 to 5	5 to 10	G3JA-D416B AC/DC24
	20	6.7 to 20	1.5 to 3.7	5.5	7.5	2 to 5	2 to 5	5 to 10	G3JA-D420B AC/DC24
	25	9.2 to 27.7	2.2 to 5.5	5.5	11	3 to 7.5	3 to 7.5	7.5 to 15	G3JA-D425B AC/DC24
	32	10.9 to 32.9	3.7 to 7.5	7.5	15	3 to 10	5 to 10	7.5 to 20	G3JA-D432B AC/DC24
	51	17.3 to 51.9	5.5 to 11	15	22	5 to 15	7.5 to 15	15 to 30	G3JA-D451B AC/DC24
	64	21.3 to 64	5.5 to 15	18.5	30	7.5 to 20	7.5 to 20	20 to 40	G3JA-D464B AC/DC24

Multi-function Soft Starters

Supply voltage	Main Circuit Operating Current (A)		KW at 350% of load			HP at 350% of load			Model
	Current rating	Adjustable range	200 VAC 50/60 Hz	230 VAC 50 Hz	380/400/415 VAC 50 Hz	200 VAC 60 Hz	230 VAC 60 Hz	460 VAC 60 Hz	
100 to 240 VAC, 50/60 Hz	3	1 to 3	0.2 to 0.4	0.55	1.1	0.5	0.5	0.5 to 1.5	G3JA-C403B AC100-240
	9	3 to 9	0.55 to 1.5	2.2	4	0.75 to 2	0.75 to 2	1.5 to 5	G3JA-C409B AC100-240
	16	5.3 to 16	1.1 to 2.2	4	7.5	1.5 to 3	1.5 to 5	5 to 10	G3JA-C416B AC100-240
	19	6.3 to 19	1.5 to 3.7	4	7.5	1.5 to 5	2 to 5	5 to 10	G3JA-C419B AC100-240
	25	8.3 to 25	2.2 to 5.5	5.5	11	3 to 7.5	3 to 7.5	7.5 to 15	G3JA-C425B AC100-240
	30	10 to 30	2.2 to 5.5	7.5	15	3 to 7.5	5 to 10	7.5 to 20	G3JA-C430B AC100-240
	37	12.3 to 37	3.7 to 7.5	7.5	18.5	5 to 10	5 to 10	10 to 25	G3JA-C437B AC100-240
24 VAC/ VDC	3	1 to 3	0.2 to 0.4	0.55	1.1	0.5	0.5	0.5 to 1.5	G3JA-C403B AC/DC24
	9	3 to 9	0.55 to 1.5	2.2	4	0.75 to 2	0.75 to 2	1.5 to 5	G3JA-C409B AC/DC24
	16	5.3 to 16	1.1 to 2.2	4	7.5	1.5 to 3	1.5 to 5	5 to 10	G3JA-C416B AC/DC24
	19	6.3 to 19	1.5 to 3.7	4	7.5	1.5 to 5	2 to 5	5 to 10	G3JA-C419B AC/DC24
	25	8.3 to 25	2.2 to 5.5	5.5	11	3 to 7.5	3 to 7.5	7.5 to 15	G3JA-C425B AC/DC24
	30	10 to 30	2.2 to 5.5	7.5	15	3 to 7.5	5 to 10	7.5 to 20	G3JA-C430B AC/DC24
	37	12.3 to 37	3.7 to 7.5	7.5	18.5	5 to 10	5 to 10	10 to 25	G3JA-C437B AC/DC24

Accessories

Description	Specification	Model
Fan	Allows increased switching frequency from 4/hr to 10/hr	G32J-CF64
Auxiliary contact	1 NO contact	G32J-CA10
Auxiliary contacts	2 NO contacts	G32J-CA20
Auxiliary contact	1 NC contact	G32J-CA01
Auxiliary contacts	1 NO + 1 NC contacts	G32J-CA11
Terminal block adapters	Set of 2	G32J-TA10

Cam Positioner H8PS



Easy-to-Use Standalone Cam Positioner Uses Encoder Input

- High-speed operation at 1600 r/min and high precision settings to 0.5°
- Advanced angle compensation function compensates for output delays
- Highly visible display with reverse-lit LCD for long-distance legibility
- Fits a 1/4 DIN panel cutout
- Front panel and surface/DIN rail mounting models (track mounting adapter optional)
- 8, 16 and 32 outputs models
- Bank function for multi-product production (8 banks)
- Use Omron absolute encoders for cam input; available with easy-to-install connector
 - E6CP-AG5C-C 256 2M for 256 pulse/rev resolution
 - E6C3-AG5C-C 360 2M for 360 pulse/rev resolution
 - E6F-AG5C-C 720 2M for 720 pulse/rev resolution
- IP40 front panel rating; waterproof and protective covers available



Specifications

- Supply voltage: 24 VDC
- Inputs: Encoder input: Connection to a dedicated absolute encoder
 - External inputs: bank inputs 1/2/4, origin input, start input (16-/32-output models)
- Control output:
 - 8-output Models: 8 cam outputs, 1 RUN output, 1 pulse output
 - 16-output Models: 16 cam outputs, 1 RUN output, 1 pulse output
 - 32-output Models: 32 cam outputs, 1 RUN output, 1 pulse output
- Output ratings:
 - Cam outputs, RUN output: NPN or PNP open collector, 100 mA at 30 VDC
 - Pulse outputs: NPN or PNP open collector, 30 mA at 30 VDC
- Dimensions: 96 H x 96 W x 65 D mm

Ordering Information

Cam Positioners

Number of outputs	Mounting method	Dimensions L x W x H mm	Output type	Bank function	Model
8 outputs	Panel mounting	96 x 96 x 67.5	NPN open collector	None	H8PS-8B
			PNP open collector	None	H8PS-8BP
8 outputs	DIN rail or surface mounting	96 x 96 x 60.6	NPN open collector	None	H8PS-8BF
			PNP open collector	None	H8PS-8BFP
16 outputs	Panel mounting	96 x 96 x 67.5	NPN open collector	None	H8PS-16B
			PNP open collector	None	H8PS-16BP
16 outputs	DIN rail or surface mounting	96 x 96 x 60.6	NPN open collector	None	H8PS-16BF
			PNP open collector	None	H8PS-16BFP
32 outputs	Panel mounting	96 x 96 x 67.5	NPN open collector	None	H8PS-32B
			PNP open collector	None	H8PS-32BP
32 outputs	DIN rail or surface mounting	96 x 96 x 60.6	NPN open collector	None	H8PS-32BF
			PNP open collector	None	H8PS-32BFP

Absolute Encoders and Couplers

Full descriptions are listed under Rotary Encoders elsewhere in this catalog.

Type	Resolution	Shaft diameter	Cable length	Encoder Model
Economy	256	6 mm	2 m	E6CP-AG5C-C 256 2M
Standard	256	8 mm	1 m	E6C3-AG5C-C 256 1M
	256	8 mm	2 m	E6C3-AG5C-C 256 2M
	360	8 mm	2 m	E6C3-AG5C-C 360 2M
	720	8 mm	2 m	E6C3-AG5C-C 720 2M
	Rugged	256	10 mm	2 m
Rugged	360	10 mm	2 m	E6F-AG5C-C 360 2M
	720	10 mm	2 m	E6F-AG5C-C 720 2M

Accessories

Description	Specification	Model
Discrete wire output cable	2 m length	Y92S-41-200
Connector type output cable	2 m length	E5ZE-CBL200
Support software	CD-ROM	H8PS-SOFT-V1
Parallel input adapter	Two units can operate in parallel	Y92C-30
Protective cover	Hard plastic, fits H8PS	Y92A-96B
Watertight cover	NEMA 4 protection for H8PS front panel	Y92A-96N
DIN-rail mounting adapter	Use with H8PS-□BF□ models	Y92F-91
Encoder extension cable	5 m length (for E5CP, E6C3-A, E6F-A)	E69-DF5

Cam Positioner C200H-CP114



PLC-Based Cam Positioner Uses Resolver Input

- Simulates mechanical cam switches, integrates control into Omron's CS1 Series PLC
- Fast operation at 800 r/min and accurate settings to 1°
- Front panel origin adjustment from 1° to 359°
- Setting/display unit panels mounts for easy setup and monitoring
- Bank function for multi-product production (8 banks each hold 48 data points)
- EPROM memory backs up bank and data settings
- CW/CCW direction, cam data protection and setting protection set by rear mounted DIP switches

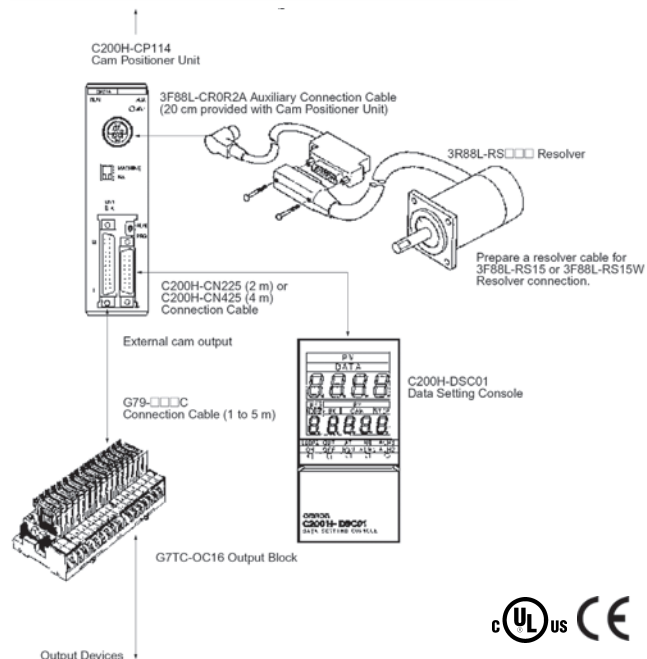
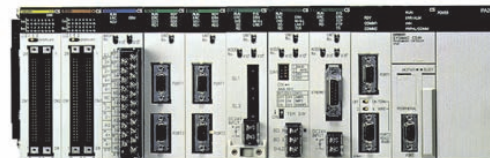

Specifications

- Supply voltage: 5 VDC from PLC
- Inputs: Resolver: 800 rpm resolution
- Angle detection cycle: 200 μs at 5 kHz sampling frequency
- Control output: 16 external NPN transistor outputs; can be assigned to internal outputs
 - 32 internal only outputs
- Number of ON/OFF control operations: 7 outputs per cam max.
- Bank function: 8 banks, each stores 48 points of cam output data

Cam Positioner

Number of inputs	Number of outputs	Mounting method	Dimensions H x W x D mm	Output type/rating	Bank function	Model
1 resolver input	48 outputs: 16 internal/external 32 internal only	CS1 PLC mounting	130 x 34.5 x 101	NPN open collector/ 100 mA at 24 VDC; 8 points max. ON simultaneously	8 banks	C200H-CP114

Resolvers

Use Omron's 3F88L-RS17 or 3F88L-RS15 series resolvers or commercially available models.

Rotary Encoders—Absolute

E6C3-A

Quick Link

P060A

Water Resistant Encoder for Tough Environments

- IP65f drip-proof, oil-proof construction with sealed bearing
- 8 mm stainless steel shaft provides superior shaft loading performance: Radial: 8 kg-f; Axial: 5.1 kg-f
- NPN, or PNP open collector or voltage outputs
- Optimum angle control when combined with cam positioner (stand-alone H8PS or PLC-based) or encoder-input PLC position control modules
- Response frequency: 20 kHz max., 5,000 rpm max.
- Pre-wired with 1 meter cable; 2 meter cable available, connector version available for direct connection to an H8PS Cam Positioning unit



Absolute Rotary Encoders

When ordering, specify the resolution in addition to the model number (example: E6C3-AG5C 360P/R 1M).

Size	Shaft	Supply voltage	Output configuration	Output code	Resolution (pulses/rotation)	Connection method	Model
50 dia. x 43 D mm	8 dia. x 15 L mm, stainless steel	12 to 24 VDC	NPN open-collector output	Gray	256, 360, 720	2 m connector for H8PS Cam Positioner	E6C3-AG5C-C
					256, 360, 720, 1,024	Pre-wired, 1 m cable	E6C3-AG5C
				Binary	32, 40		E6C3-AN5C
			BCD	6, 8, 12	E6C3-AB5C		
			PNP open-collector output	Gray	256, 360, 720, 1,024	E6C3-AG5B	
				Binary	32, 40	E6C3-AN5B	
		BCD		6, 8, 12	E6C3-AB5B		
		5 VDC 12 VDC	Voltage output	Binary	256	E6C3-AN1E	
						E6C3-AN2E	

Rotary Encoders—Absolute E6CP



Low-Cost Absolute Encoder, 50 mm Diameter

- High-precision detection of automatic machine timing, also ideal for robot limit signals
- Absolute encoder performance at the cost of an incremental encoder
- Gray code output eliminates reading mistakes
- Lightweight, plastic body construction, IP50 enclosure rating
- Shaft loading: Radial: 3 kg-f; Axial: 2 kg-f
- Open collector output
- Response frequency: 5 kHz max., 1,000 rpm max.
- Pre-wired with 2-meter cable, connector version available for direct connection to an H8PS Cam Positioning unit



Absolute Rotary Encoders

Size	Shaft	Power supply voltage	Output configuration	Output code	Resolution (pulses/rotation)	Connection method	Model
50 dia. x 55 D mm	6 dia. x 10 L mm	5 to 12 VDC	Open-collector output	Gray	256 (8-bit)	Pre-wired, 2 m cable	E6CP-AG3C
		12 to 24 VDC					E6CP-AG5C
						2 m cable with connector for H8PS Cam Positioner	E6CP-AG5C-C

Rotary Encoders—Absolute

E6F-A

Quick Link

F031

Rugged Encoder for High-Precision Detection

- 10 mm stainless steel shaft and rugged construction provide the highest shaft loading among Omron encoders: Radial: 12 kg-f, Thrust: 5 kg-f
- IP65f water and oil-proof construction
- High response speed for faster control: Gray code: 20 kHz; BCD: 10 kHz, 5,000 rpm max.
- Combine with H8PS Cam Positioner or PLC encoder input module for optimum angle control
- Pre-wired with 2-meter cable, connector version available for direct connection to an H8PS Cam Positioning unit



Absolute Rotary Encoders

When ordering, specify the resolution in addition to the model number (example: E6F-AG5C 256 P/R).

Size	Shaft	Power supply voltage	Output configuration	Output code	Resolution (pulses/ rotation)	Connection method	Model
60 mm dia. x 65 D mm	10 dia. x 20 L mm	5 to 12 VDC	NPN open collector	BCD	360	Pre-wired 2 m cable	E6F-AB3C
			NPN open collector	BCD	360	Pre-wired 2 m cable	E6F-AB5C
		12 to 24 VDC	PNP open collector	BCD	360	Pre-wired 2 m cable	E6F-AB5B
			NPN open collector	Gray code	256, 360, 720	2 m cable with connector for H8PS Cam Positioner	E6F-AG5C-C
			NPN open collector		256, 360, 720,	Pre-wired 2 m cable	E6F-AG5C
			PNP open collector		1,024		E6F-AG5B

Rotary Encoders—Incremental

E6A2-C

Quick Link

F020

Miniature Positioning Solution for Tight Spaces

- High response frequency and noise immunity make encoders ideal for factory automation applications with 10 to 500 pulses/revolution
- Space saving enclosure: 25 mm dia.
- 4 mm shaft with load rating of: Radial: 1 kg-f; Axial: 0.5 kg-f
- Open collector output, other output types available
- Output phases: A/A, B and A, B, Z (reversible) are available
- Response frequency: 20 kHz max., 5,000 rpm max.
- Enclosure rating: IP50
- Pre-wired with 0.5 meter cable



Incremental Rotary Encoders

Size	Shaft	Supply voltage	Output configuration	Resolution (pulses/ revolution)	Model
25 dia. x 31 D mm	4 dia. x 10 L mm	12 to 24 VDC	NPN open collector, 30 mA max.	100	E6A2-CW5C 100P/R 05M
				200	E6A2-CW5C 200P/R 05M

Rotary Encoders—Incremental

E6B2-C

Quick Link

F022

General-Purpose Compact Encoders

- High resolution models (up to 2000 pulses per revolution available) substantially improve measuring accuracy
- Rugged construction: 6 mm shaft with load rating of: Radial: 3 kg-f; Axial: 2 kg-f
- Output phases: A, B, Z (reversible)
- Response frequency: up to 100 kHz max., 6,000 rpm max.
- Protected against short-circuit and reversed connections for highly reliable operation
- Available with NPN and PNP open collector, voltage and line driver outputs
- Enclosure rating: IP50
- Pre-wired with 0.5- or 2-meter cables



Incremental Rotary Encoders

Size	Shaft	Supply voltage	Output configuration	Resolution (pulses/ revolution)	Cable length	Model
40 mm dia. x 44 D mm	6 dia. x 15 L mm	12 to 24 VDC	NPN open collector, 35 mA max.	100	2 m	E6B2-CWZ6C 100P/R 2M
				200	2 m	E6B2-CWZ6C 200P/R 2M
				360	0.5 m	E6B2-CWZ6C 360P/R 05M
				360	2 m	E6B2-CWZ6C 360P/R 2M
				500	2 m	E6B2-CWZ6C 500P/R 2M
				600	2 m	E6B2-CWZ6C 600P/R 2M
				1000	0.5 m	E6B2-CWZ6C 1000P/R 05M
				1000	2 m	E6B2-CWZ6C 1000P/R 2M
		5 VDC	Line driver: High: -20 mA or 2.5 V min. Low: +20 mA or 0.5 V max.	1000	0.5 m	E6B2-CWZ1X 1000P/R 05M

Rotary Encoders—Incremental E6C3-C



Water Resistant Incremental Encoder for Tough Environments

- High resolution solutions from 100 to 3600 pulses/revolution
- IP65f drip-proof, oil-proof construction with sealed bearing
- 8 mm stainless steel shaft provides a load rating of: Radial: 88 kg-f; Axial: 5 kg-f
- Complementary outputs simplify interfacing to NPN or PNP input devices
- Output phases: A, B and Z (reversible)
- Response frequency: 125 kHz max. (65 kHz for Z-phase), 5,000 rpm max.
- Surge protection built in
- Voltage and line driver output versions available
- Pre-wired with 1 meter cable, 2 meter cable is available



Incremental Rotary Encoders-Complementary NPN and PNP Outputs

Size	Shaft	Supply voltage	Output configuration	Resolution (pulses/ revolution)	Model
50 dia. x 43 D mm	8 dia. x 15 L mm, stainless steel	12 to 24 VDC	<p>Complementary output (NPN and PNP), 35 mA max.</p>	100	E6C3-CWZ5GH 100P/R 1M
				200	E6C3-CWZ5GH 200P/R 1M
				360	E6C3-CWZ5GH 360P/R 1M
				500	E6C3-CWZ5GH 500P/R 1M
				720	E6C3-CWZ5GH 720P/R 1M
				800	E6C3-CWZ5GH 800P/R 1M
				1000	E6C3-CWZ5GH 1000P/R 1M
				2048	E6C3-CWZ5GH 2048P/R 1M
				2500	E6C3-CWZ5GH 2500P/R 1M
				3600	E6C3-CWZ5GH 3600P/R 1M

Rotary Encoders—Incremental

E6D

Quick Link

F030

Rugged, High-Resolution Encoder

- Resolution as high as 6,000 pulses/revolution in a rugged construction
- Outputs: A, B (reversible) and Z (zero)
- 55 mm diameter housing
- Superb reliability and accuracy: phase error as small as 1/4T ±0.07T
- High response frequency of 200 kHz, 12,000 rpm max.
- 6 mm shaft with load rating of: radial: 5 kg-f; axial: 3 kg-f



Incremental Rotary Encoders

Add resolution (pulses/revolution) before P/R in the model number.

Size	Shaft	Supply voltage	Output configuration	Resolution (pulses/ revolution)	Cable length	Model
40 mm dia. x 44 D mm	6 dia. x 15 L mm	12 VDC	NPN open collector, 35 mA max.	720, 800, 1000, 1024, 1200, 1500, 1800, 2000, 2048, 2500, 3000, 3200, 3600, 4096, 5000, 6000	0.5 m	E6D-CWZ2C□□□□P/R 05M
		5 VDC			0.5 m	E6D-CWZ1E□□□□P/R 05M

Rotary Encoders—Incremental

E6F-C

Quick Link

Q037

Rugged Encoder with Strongest Shaft

- 10 mm stainless steel shaft and rugged construction provides the highest shaft loading among Omron encoders: Radial: 12 kg-f, Thrust: 5 kg-f
- IP65f water- and oil-proof construction
- 60 mm diameter housing
- Complementary output for longer cable length extension
- High response frequency of 83 kHz, 5,000 rpm max.
- Output load short-circuit protection to reduce risks from incorrect wiring
- Pre-wired 2 meter cable



Incremental Rotary Encoders

Add resolution (pulses/revolution) before P/R in the model number.

Size	Shaft	Supply voltage	Output configuration	Resolution (pulses/ revolution)	Cable length	Model
60 mm dia. x 65 D mm	10 dia. x 20 L mm	12 to 24 VDC	Complementary NPN and PNP, ±30 mA	100, 200, 360, 500, 600, 1000	2 m	E6F-CWZ5GP/R 2M

Terms and Conditions of Sale

- Offer; Acceptance.** These terms and conditions (these "Terms") are deemed part of all quotes, agreements, purchase orders, acknowledgments, price lists, catalogs, manuals, brochures and other documents, whether electronic or in writing, relating to the sale of products or services (collectively, the "Products") by Omron Electronics LLC and its subsidiary companies ("Omron"). Omron objects to any terms or conditions proposed in Buyer's purchase order or other documents which are inconsistent with, or in addition to, these Terms.
- Prices; Payment Terms.** All prices stated are current, subject to change without notice by Omron. Omron reserves the right to increase or decrease prices on any unshipped portions of outstanding orders. Payments for Products are due net 30 days unless otherwise stated in the invoice.
- Discounts.** Cash discounts, if any, will apply only on the net amount of invoices sent to Buyer after deducting transportation charges, taxes and duties, and will be allowed only if (i) the invoice is paid according to Omron's payment terms and (ii) Buyer has no past due amounts.
- Interest.** Omron, at its option, may charge Buyer 1-1/2% interest per month or the maximum legal rate, whichever is less, on any balance not paid within the stated terms.
- Orders.** Omron will accept no order less than \$200 net billing.
- Governmental Approvals.** Buyer shall be responsible for, and shall bear all costs involved in, obtaining any government approvals required for the importation or sale of the Products.
- Taxes.** All taxes, duties and other governmental charges (other than general real property and income taxes), including any interest or penalties thereon, imposed directly or indirectly on Omron or required to be collected directly or indirectly by Omron for the manufacture, production, sale, delivery, importation, consumption or use of the Products sold hereunder (including customs duties and sales, excise, use, turnover and license taxes) shall be charged to and remitted by Buyer to Omron.
- Financial.** If the financial position of Buyer at any time becomes unsatisfactory to Omron, Omron reserves the right to stop shipments or require satisfactory security or payment in advance. If Buyer fails to make payment or otherwise comply with these Terms or any related agreement, Omron may (without liability and in addition to other remedies) cancel any unshipped portion of Products sold hereunder and stop any Products in transit until Buyer pays all amounts, including amounts payable hereunder, whether or not then due, which are owing to it by Buyer. Buyer shall in any event remain liable for all unpaid accounts.
- Cancellation; Etc.** Orders are not subject to rescheduling or cancellation unless Buyer indemnifies Omron against all related costs or expenses.
- Force Majeure.** Omron shall not be liable for any delay or failure in delivery resulting from causes beyond its control, including earthquakes, fires, floods, strikes or other labor disputes, shortage of labor or materials, accidents to machinery, acts of sabotage, riots, delay in or lack of transportation or the requirements of any government authority.
- Shipping; Delivery.** Unless otherwise expressly agreed in writing by Omron:
 - Shipments shall be by a carrier selected by Omron; Omron will not drop ship except in "break down" situations.
 - Such carrier shall act as the agent of Buyer and delivery to such carrier shall constitute delivery to Buyer;
 - All sales and shipments of Products shall be FOB shipping point (unless otherwise stated in writing by Omron), at which point title and risk of loss shall pass from Omron to Buyer; provided that Omron shall retain a security interest in the Products until the full purchase price is paid;
 - Delivery and shipping dates are estimates only; and
 - Omron will package Products as it deems proper for protection against normal handling and extra charges apply to special conditions.
- Claims.** Any claim by Buyer against Omron for shortage or damage to the Products occurring before delivery to the carrier must be presented in writing to Omron within 30 days of receipt of shipment and include the original transportation bill signed by the carrier noting that the carrier received the Products from Omron in the condition claimed.
- Warranties.** (a) **Exclusive Warranty.** Omron's exclusive warranty is that the Products will be free from defects in materials and workmanship for a period of twelve months from the date of sale by Omron (or such other period expressed in writing by Omron). Omron disclaims all other warranties, express or implied. (b) **Limitations.** OMRON MAKES NO WARRANTY OR REPRESENTATION, EXPRESS OR IMPLIED, ABOUT NON-INFRINGEMENT, MERCHANTABILITY OR FITNESS FOR A PARTICULAR PURPOSE OF THE PRODUCTS. BUYER ACKNOWLEDGES THAT IT ALONE HAS DETERMINED THAT THE PRODUCTS WILL SUITABLY MEET THE REQUIREMENTS OF THEIR INTENDED USE. Omron further disclaims all warranties and responsibility of any type for claims or expenses based on infringement by the Products or otherwise of any intellectual property right. (c) **Buyer Remedy.** Omron's sole obligation hereunder shall be, at Omron's election, to (i) replace (in the form originally shipped with Buyer responsible for labor charges for removal or replacement thereof) the non-complying Product, (ii) repair the non-complying Product, or (iii) repay or credit Buyer an amount equal to the purchase price of the non-complying Product; provided that in no event shall Omron be responsible for warranty, repair, indemnity or any other claims or expenses regarding the Products unless Omron's analysis confirms that the Products were properly handled, stored, installed and maintained and not subject to contamination, abuse, misuse or inappropriate modification. Return of any Products by Buyer must be approved in writing by Omron before shipment. Omron Companies shall not be liable for the suitability or unsuitability or the results from the use of Products in combination with any electrical or electronic components, circuits, system assemblies or any other materials or substances or environments. Any advice, recommendations or information given orally or in writing, are not to be construed as an amendment or addition to the above warranty. See <http://www.omron247.com> or contact your Omron representative for published information.
- Limitation on Liability; Etc.** OMRON COMPANIES SHALL NOT BE LIABLE FOR SPECIAL, INDIRECT, INCIDENTAL, OR CONSEQUENTIAL DAMAGES, LOSS OF PROFITS OR PRODUCTION OR COMMERCIAL LOSS IN ANY WAY CONNECTED WITH THE PRODUCTS, WHETHER SUCH CLAIM IS BASED IN CONTRACT, WARRANTY, NEGLIGENCE OR STRICT LIABILITY. Further, in no event shall liability of Omron Companies exceed the individual price of the Product on which liability is asserted.
- Indemnities.** Buyer shall indemnify and hold harmless Omron Companies and their employees from and against all liabilities, losses, claims, costs and expenses (including attorney's fees and expenses) related to any claim, investigation, litigation or proceeding (whether or not Omron is a party) which arises or is alleged to arise from Buyer's acts or omissions under these Terms or in any way with respect to the Products. Without limiting the foregoing, Buyer (at its own expense) shall indemnify and hold harmless Omron and defend or settle any action brought against such Companies to the extent based on a claim that any Product made to Buyer specifications infringed intellectual property rights of another party.
- Property; Confidentiality.** Any intellectual property in the Products is the exclusive property of Omron Companies and Buyer shall not attempt to duplicate it in any way without the written permission of Omron. Notwithstanding any charges to Buyer for engineering or tooling, all engineering and tooling shall remain the exclusive property of Omron. All information and materials supplied by Omron to Buyer relating to the Products are confidential and proprietary, and Buyer shall limit distribution thereof to its trusted employees and strictly prevent disclosure to any third party.
- Export Controls.** Buyer shall comply with all applicable laws, regulations and licenses regarding (i) export of products or information; (ii) sale of products to "forbidden" or other proscribed persons; and (iii) disclosure to non-citizens of regulated technology or information.
- Miscellaneous.** (a) **Waiver.** No failure or delay by Omron in exercising any right and no course of dealing between Buyer and Omron shall operate as a waiver of rights by Omron. (b) **Assignment.** Buyer may not assign its rights hereunder without Omron's written consent. (c) **Law.** These Terms are governed by the law of the jurisdiction of the home office of the Omron company from which Buyer is purchasing the Products (without regard to conflict of law principles). (d) **Amendment.** These Terms constitute the entire agreement between Buyer and Omron relating to the Products, and no provision may be changed or waived unless in writing signed by the parties. (e) **Severability.** If any provision hereof is rendered ineffective or invalid, such provision shall not invalidate any other provision. (f) **Setoff.** Buyer shall have no right to set off any amounts against the amount owing in respect of this invoice. (g) **Definitions.** As used herein, "including" means "including without limitation"; and "Omron Companies" (or similar words) mean Omron Corporation and any direct or indirect subsidiary or affiliate thereof.

Certain Precautions on Specifications and Use

- Suitability of Use.** Omron Companies shall not be responsible for conformity with any standards, codes or regulations which apply to the combination of the Product in the Buyer's application or use of the Product. At Buyer's request, Omron will provide applicable third party certification documents identifying ratings and limitations of use which apply to the Product. This information by itself is not sufficient for a complete determination of the suitability of the Product in combination with the end product, machine, system, or other application or use. Buyer shall be solely responsible for determining appropriateness of the particular Product with respect to Buyer's application, product or system. Buyer shall take application responsibility in all cases but the following is a non-exhaustive list of applications for which particular attention must be given:
 - Outdoor use, uses involving potential chemical contamination or electrical interference, or conditions or uses not described in this document.
 - Use in consumer products or any use in significant quantities.
 - Energy control systems, combustion systems, railroad systems, aviation systems, medical equipment, amusement machines, vehicles, safety equipment, and installations subject to separate industry or government regulations.
 - Systems, machines and equipment that could present a risk to life or property. Please know and observe all prohibitions of use applicable to this Product.

NEVER USE THE PRODUCT FOR AN APPLICATION INVOLVING SERIOUS RISK TO LIFE OR PROPERTY OR IN LARGE QUANTITIES WITHOUT ENSURING THAT THE SYSTEM AS A WHOLE HAS BEEN DESIGNED TO ADDRESS THE RISKS, AND THAT THE OMRON'S PRODUCT IS PROPERLY RATED AND INSTALLED FOR THE INTENDED USE WITHIN THE OVERALL EQUIPMENT OR SYSTEM.
- Programmable Products.** Omron Companies shall not be responsible for the user's programming of a programmable Product, or any consequence thereof.
- Performance Data.** Data presented in Omron Company websites, catalogs and other materials is provided as a guide for the user in determining suitability and does not constitute a warranty. It may represent the result of Omron's test conditions, and the user must correlate it to actual application requirements. Actual performance is subject to the Omron's Warranty and Limitations of Liability.
- Change in Specifications.** Product specifications and accessories may be changed at any time based on improvements and other reasons. It is our practice to change part numbers when published ratings or features are changed, or when significant construction changes are made. However, some specifications of the Product may be changed without any notice. When in doubt, special part numbers may be assigned to fix or establish key specifications for your application. Please consult with your Omron's representative at any time to confirm actual specifications of purchased Product.
- Errors and Omissions.** Information presented by Omron Companies has been checked and is believed to be accurate; however, no responsibility is assumed for clerical, typographical or proofreading errors or omissions.

Complete "Terms and Conditions of Sale" for product purchase and use are on Omron's website at www.omron.com/oei – under the "About Us" tab, in the Legal Matters section.

ALL DIMENSIONS SHOWN ARE IN MILLIMETERS.

To convert millimeters into inches, multiply by 0.03937. To convert grams into ounces, multiply by 0.03527.

OMRON[®]**OMRON ELECTRONICS LLC**

1 Commerce Drive
Schaumburg, IL 60173
Tel: 847.843.7900

For U.S. technical support or other
inquiries: 800.556.6766

OMRON CANADA, INC.

885 Milner Avenue
Toronto, Ontario M1B 5V8
Tel: 416.286.6465

MEXICO SALES OFFICES

Mexico, D.F. (52) 555 660 31 44
Ciudad Juárez (52) 656 623 70 83
Monterrey, N.L. (52) 818 377 42 81
Mexicali, B.C. (52) 686 838 01 15

BRAZIL SALES OFFICES

Sao Paulo (55) 11 2101 6300

ARGENTINA SALES OFFICES

Cono Sur (54) 11 4787 1129

CHILE SALES OFFICES

Santiago (56) 2206 4592

OTHER LATIN AMERICAN SALES

mela@omron.com

OMRON ON-LINE

Global –
www.omron.com

USA –
www.omron247.com

Canada –
www.omron.ca

Brazil –
www.omron.com.br