

阅读申明

- 1.本站收集的数据手册和产品资料都来自互联网，版权归原作者所有。如读者和版权方有任何异议请及时告之，我们将妥善解决。
- 2.本站提供的中文数据手册是英文数据手册的中文翻译，其目的是协助用户阅读，该译文无法自动跟随原稿更新，同时也可能存在翻译上的不当。建议读者以英文原稿为参考以便获得更精准的信息。
- 3.本站提供的产品资料，来自厂商的技术支持或者使用者的心得体会等，其内容可能存在描述上的差异，建议读者做出适当判断。
- 4.如需与我们联系，请发邮件到marketing@iczoom.com，主题请标有“数据手册”字样。

Read Statement

1. The datasheets and other product information on the site are all from network reference or other public materials, and the copyright belongs to the original author and original published source. If readers and copyright owners have any objections, please contact us and we will deal with it in a timely manner.
2. The Chinese datasheets provided on the website is a Chinese translation of the English datasheets. Its purpose is for reader's learning exchange only and do not involve commercial purposes. The translation cannot be automatically updated with the original manuscript, and there may also be improper translations. Readers are advised to use the English manuscript as a reference for more accurate information.
3. All product information provided on the website refer to solutions from manufacturers' technical support or users the contents may have differences in description, and readers are advised to take the original article as the standard.
4. If you have any questions, please contact us at marketing@iczoom.com and mark the subject with "Datasheets" .

R7M-A□, R7M-AP□

SmartStep servo motors

The smart alternative to stepper motors

- SmartStep motors can be controlled by SmartStep drive and XtraDrive
- Cylindrical and flat servo motor types are available
- Easy to setup, easy to operate. SmartStep is as easy to use as a stepper motor
- Front-panel switches in the SmartStep drive make settings easy and eliminate the need for time-consuming parameter settings
- Extended features and embedded in drive control can be provided using intelligent XtraDrive
- Models with brake available
- Easy to connect to the drive using prebuilt cables



Ratings

- 230 VAC from 30 W to 750 W
(0.095 Nm to 2.39 Nm)

System configuration

(Refer to servo drive chapter)



Servo Drive controlled by pulses

SmartStep Servo Drive

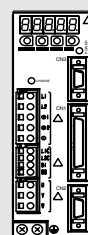

Intelligent Servo Drive

XtraDrive

Drive options

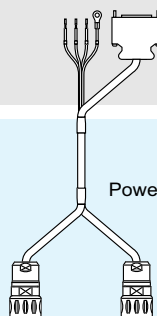

Power and encoder cables

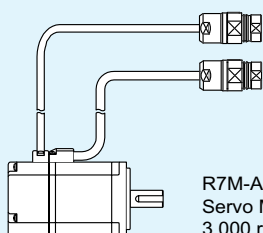

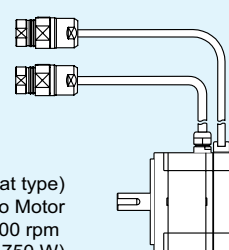

R7M-A (cylindrical type)
Servo Motor
3,000 rpm
(30-750 W)



R7M-AP (flat type)
Servo Motor
3,000 rpm
(100-750 W)

Servo motor / servo drive combination

SmarStep servo motor				SmartStep servo drive	XtraDrive servo drive
	Voltage	Rated torque	Capacity	Model	230 V (1-phase)
 R7M-A (3000 min ⁻¹)	230 V	0.095 Nm	30 W	R7M-A03030-□	R7D-APA3H
		0.159 Nm	50 W	R7M-A05030-□	R7D-APA5H
		0.318 Nm	100 W	R7M-A10030-□	R7D-AP01H
		0.637 Nm	200 W	R7M-A20030-□	R7D-AP02H
		1.27 Nm	400 W	R7M-A40030-□	R7D-AP04H
		2.39 Nm	750 W	R7M-A75030-□	R7D-AP08H
 R7M-AP(3000 min ⁻¹)	230 V	0.318 Nm	100 W	R7M-AP10030-□	R7D-AP01H
		0.637 Nm	200 W	R7M-AP20030-□	R7D-AP02H
		1.27 Nm	400 W	R7M-AP40030-□	R7D-AP04H
		2.39 Nm	750 W	R7M-AP75030-□	R7D-AP08H

Note: 1. For servo motor and cable part numbers, refer to ordering information at the end of this chapter.
 2. Refer to the servo drive chapter for drive options selection and detailed specifications.

Servo motor specifications

General specifications

Item	Specification
Ambient operating temperature	0 to 40 °C
Ambient operating humidity	20% to 80% (with no condensation)
Ambient storage temperature	-20 to 60 °C
Ambient storage humidity	20% to 80% (with no condensation)
Storage/operating atmosphere	No corrosive gases.
Vibration resistance	10 to 2,500 Hz in X, Y, and Z directions with 0.2 mm double amplitude or acceleration of 24.5 m/s ² max., whichever is smaller
Impact resistance	Acceleration 98 m/s ² max., in a vertical direction, two times
Insulation resistance	Between power line terminals and FG: 10 MΩ min. (at 500 VDC)
Dielectric strength	Between power line terminals and FG: 1,500 VAC for 1 min at 50/60 Hz
Run position	Any direction
Insulation grade	Type B
Structure	Totally-enclosed self-cooling
Protective structure	IP55 for both the cylindrical and flat servo motors
Vibration grade	V-15
Mounting method	Flange-mounting
International standards	Approval obtained for UL, cUL, and EN (EMC directive and low-voltage directive)

Performance specifications

Flat servo motors

Item	R7M-AP10030-□	R7M-AP20030-□	R7M-AP40030-□	R7M-AP75030-□	
Rated output	100 W	200 W	400 W	750 W	
Rated torque	0.318 N·m	0.637 N·m	1.27 N·m	2.39 N·m	
Rated rotation speed	3,000 r/min	3,000 r/min	3,000 r/min	3,000 r/min	
Momentary maximum rotation speed	4,500 r/min	4,500 r/min	4,500 r/min	4,500 r/min	
Momentary maximum torque	0.96 N·m	1.91 N·m	3.82 N·m	7.1 N·m	
Rated current	0.89 A (rms)	2.0 A (rms)	2.6 A (rms)	4.1 A (rms)	
Momentary maximum current	2.8 A (rms)	6.0 A (rms)	8.0 A (rms)	13.9 A (rms)	
Rotor inertia	6.5 × 10 ⁻⁶ kg·m ²	2.09 × 10 ⁻⁵ kg·m ²	3.47 × 10 ⁻⁵ kg·m ²	2.11 × 10 ⁻⁴ kg·m ²	
Power rate	15.7 kW/s	19.4 kW/s	46.8 kW/s	26.9 kW/s	
Allowable radial load	78 N	245 N	245 N	392 N	
Allowable thrust load	49 N	68 N	68 N	147 N	
Weight	Without brake	0.7 kg	1.4 kg	2.1 kg	
	With brake	0.9 kg	1.9 kg	2.6 kg	
Encoder resolution	2,000 pulses/revolution for phase-A and phase-B, 1 pulse/revolution for phase-Z				
Radiation shield dimensions	t6 × 250 mm square			t12 × 300 mm square	
Brake specifications	Brake inertia	3.1 × 10 ⁻⁶ kg·m ²	1.52 × 10 ⁻⁵ kg·m ²	1.52 × 10 ⁻⁵ kg·m ²	
	Excitation voltage	24 VDC ±10%			
	Power consumption (at 20 °C)	7.5 W	7.6 W	8.2 W	7.5 W
	Current consumption (at 20 °C)	0.31 A	0.32 A	0.34 A	0.31 A
	Static friction torque	0.4 N·m min.	0.9 N·m min.	1.9 N·m min.	3.5 N·m min.
	Attraction time	60 ms max.	40 ms max.	60 ms max.	20 ms max.
	Release time	20 ms max.	20 ms max.	20 ms max.	40 ms max.
	Backlash	1°	1°	1°	1°
	Rating	Continuous	Continuous	Continuous	Continuous
	Insulation grade	Type F	Type F	Type F	Type F
Applicable servo driver (R7D-)	AP01H	AP02H	AP04H	AP08H	

Cylindrical servo motors

Item	R7M-A03030-□	R7M-A05030-□	R7M-A10030-□	R7M-A20030-□	R7M-A40030-□	R7M-A75030-□	
Rated output	30 W	50 W	100 W	200 W	400 W	750 W	
Rated torque	0.095 N·m	0.159 N·m	0.318 N·m	0.637 N·m	1.27 N·m	2.39 N·m	
Rated rotation speed	3,000 r/min	3,000 r/min	3,000 r/min	3,000 r/min	3,000 r/min	3,000 r/min	
Momentary maximum rotation speed	4,500 r/min	4,500 r/min	4,500 r/min	4,500 r/min	4,500 r/min	4,500 r/min	
Momentary maximum torque	0.29 N·m	0.48 N·m	0.96 N·m	1.91 N·m	3.82 N·m	7.1 N·m	
Rated current	0.42 A (rms)	0.6 A (rms)	0.87 A (rms)	2.0 A (rms)	2.6 A (rms)	4.4 A (rms)	
Momentary maximum current	1.3 A (rms)	1.9 A (rms)	2.8 A (rms)	6.0 A (rms)	8.0 A (rms)	13.9 A (rms)	
Rotor inertia	1.7×10^{-6} kg·m ²	2.2×10^{-6} kg·m ²	3.6×10^{-6} kg·m ²	1.19×10^{-5} kg·m ²	1.87×10^{-5} kg·m ²	6.67×10^{-5} kg·m ²	
Power rate	5.31 kW/s	11.5 kW/s	28.1 kW/s	34.1 kW/s	86.3 kW/s	85.6 kW/s	
Allowable radial load	68 N	68 N	78 N	245 N	245 N	392 N	
Allowable thrust load	54 N	54 N	54 N	74 N	74 N	147 N	
Weight	Without brake	0.3 kg	0.4 kg	0.5 kg	1.1 kg	1.7 kg	3.4 kg
	With brake	0.6 kg	0.7 kg	0.8 kg	1.6 kg	2.2 kg	4.3 kg
Encoder resolution	2,000 pulses/revolution for phase-A and phase-B, 1 pulse/revolution for phase-Z						
Radiation shield dimensions	t6 × 250 mm square						
Brake specifications	Brake inertia	0.85×10^{-6} kg·m ²	0.85×10^{-6} kg·m ²	0.85×10^{-6} kg·m ²	6.4×10^{-6} kg·m ²	6.4×10^{-6} kg·m ²	1.7×10^{-5} kg·m ²
	Excitation voltage	24 VDC ±10% V					
	Power consumption (at 20 °C)	6 W	6 W	6 W	7 W	7 W	7.7 W
	Current consumption (at 20 °C)	0.25 A	0.25 A	0.25 A	0.29 A	0.29 A	0.32 A
	Static friction torque	0.2 N·m min.	0.2 N·m min.	0.34 N·m min.	1.47 N·m min.	1.47 N·m min.	2.45 N·m min.
	Attraction time	30 ms max.	30 ms max.	30 ms max.	60 ms max.	60 ms max.	60 ms max.
	Release time	60 ms max.	60 ms max.	60 ms max.	20 ms max.	20 ms max.	20 ms max.
	Backlash	1°	1°	1°	1°	1°	1°
	Rating	Continuous	Continuous	Continuous	Continuous	Continuous	Continuous
Insulation grade	Type F	Type F	Type F	Type F	Type F	Type F	
Applicable servo driver (R7D-)	APA3H	APA5H	AP01H	AP02H	AP04H	AP08H	

Torque and rotation speed characteristics

Flat servo motors

The following graphs show the characteristics with a 3 m standard cable and R7D-AP□H servo driver (200 VAC input)

R7M-AP10030 (100 W)

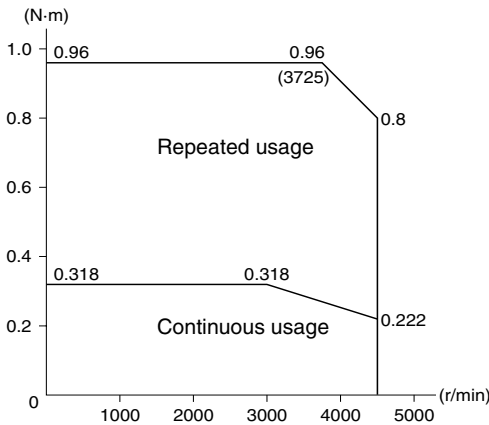

R7M-AP20030 (200 W)

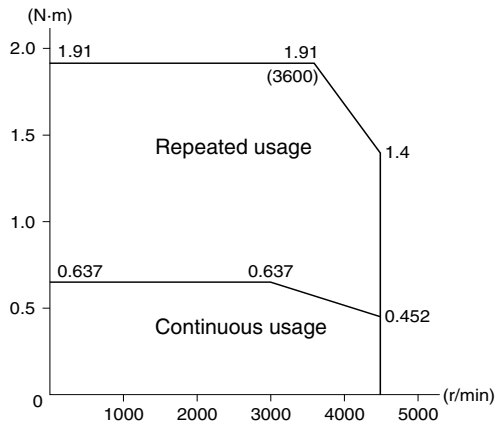

R7M-AP40030 (400 W)

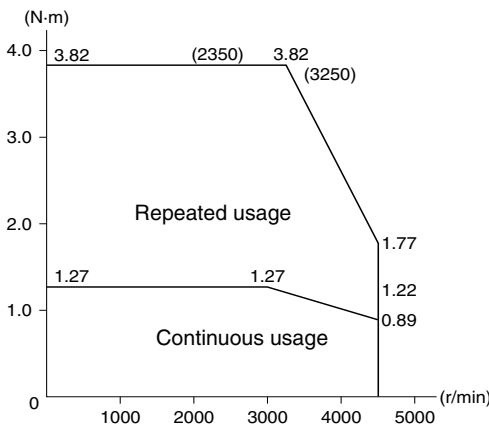

R7M-AP75030 (750 W)

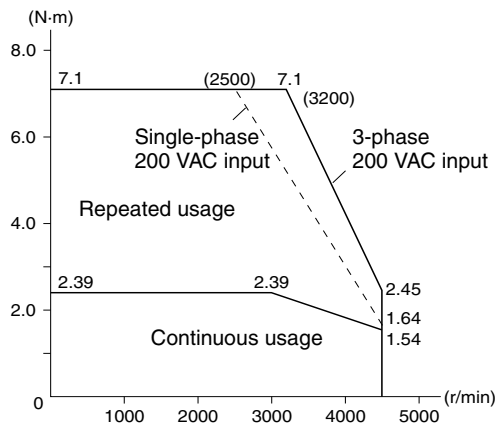

Torque and rotation speed characteristics

Cylindrical servo motors

The following graphs show the characteristics with a 3 m standard cable and an R7D-AP□H servo driver (200 VAC input.)

R7M-A03030 (30 W)

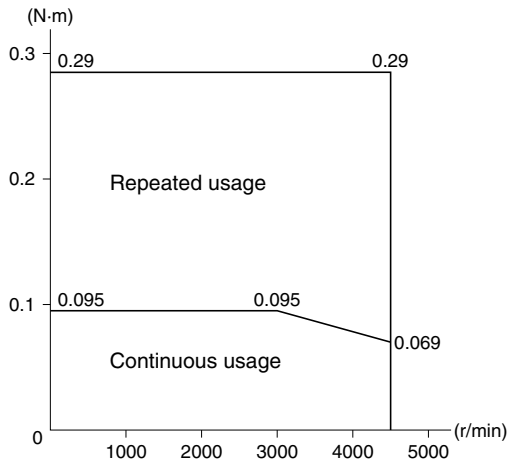

R7M-A05030 (50 W)

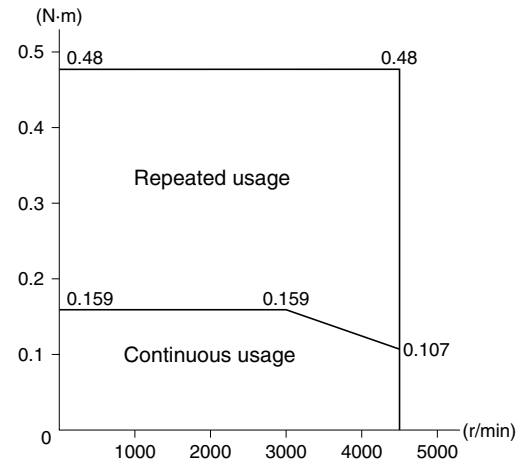

R7M-A10030 (100 W)

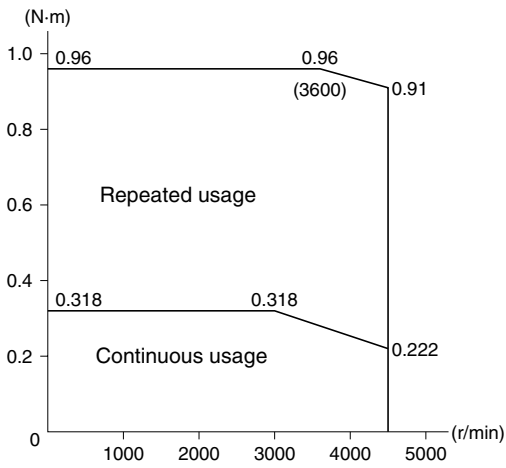

R7M-A20030 (200 W)

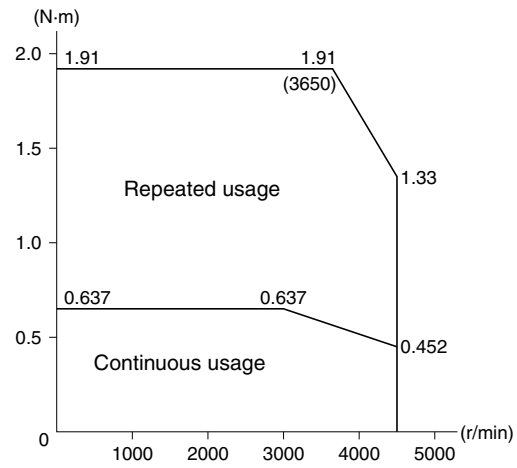

R7M-A40030 (400 W)

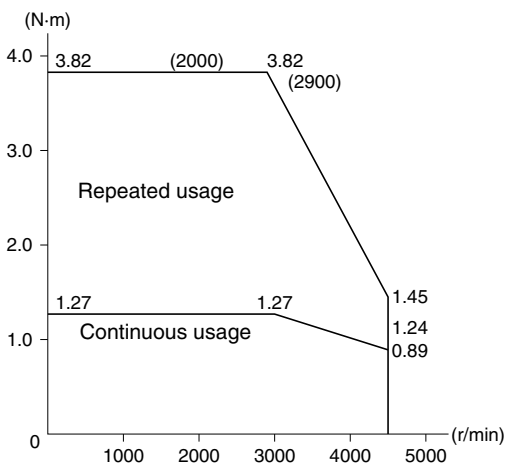

R7M-A75030 (750 W)

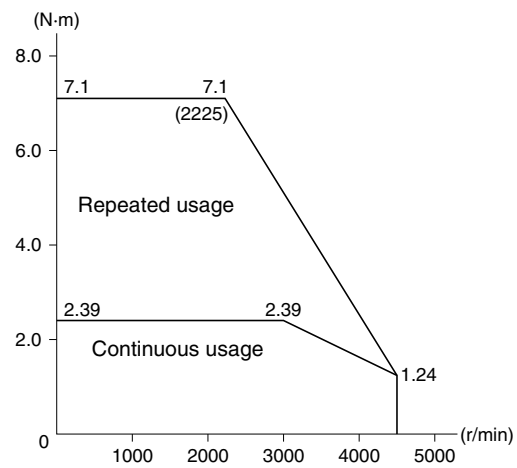

Dimensions

Cylindrical servo motors (3,000 r/min)
200 VAC: 30W/50W/100W/200W/400W/750W

Without brake: R7M-A03030-S1-D/A05030-S1-D/A10030-S1-D/A20030-S1-D/A40030-S1-D/A75030-S1-D
With brake: R7M-A03030-BS1-D/A05030-BS1-D/A10030-BS1-D/A20030-BS1-D/A40030-BS1-D/A75030-BS1-D

Model	Dimensions (mm)																							
	LL		LR	Flange surface						Axis end														
	Without brake	With brake		C	D1	D2	F	G	Z	S	QK	b	h	t1										
R7M-A03030□	69.5	101	25	40	46	30h7	2.5	5	Two, 4.3 dia.	6h6	14	2	2	1.2										
R7M-A05030□	77	108.5		30	60	70	50h7	3		6					8h6	20	3	3	1.8					
R7M-A10030□	94.5	135																		40	80	90	70h7	3
R7M-A20030□	96.5	136	30	60	70	50h7	3	6	14h6	20	5	5	3											
R7M-A40030□	124.5	164												30	60	70	50h7	3	6					
R7M-A75030□	145	189.5	40	80	90	70h7	3	8	Four, 7 dia.	16h6	30	5	5							3				

R7M-A□□□30-S1-D (Without brake)

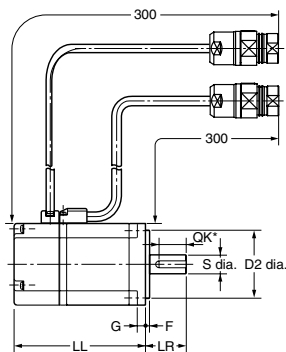

R7M-A□□□30-BS1-D (With brake)

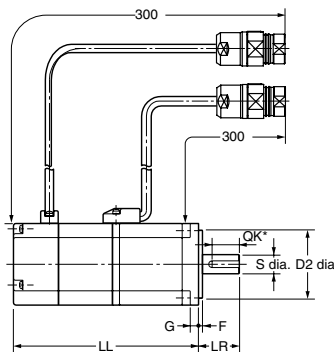

Axis end dimensions

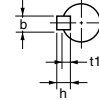

Hole with "Z" mark

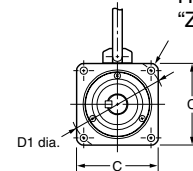

Flat servo motors (3,000 r/min)
200 VAC: 100W/200W/400W/750W

Without brake: R7M-AP10030-S1-D/AP20030-S1-D/AP40030-S1-D/AP75030-S1-D
With brake: R7M-AP10030-BS1-D/AP20030-BS1-D/AP40030-BS1-D/AP75030-BS1-D

Model	Dimensions (mm)													
	LL		LR	Flange surface						Axis End				
	Without brake	With brake		C	D1	D2	F	G	Z	S	QK	b	h	t1
R7M-AP10030□	62	91	25	60	70	50h7	3	6	5.5	8h6	14	3	3	1.8
R7M-AP20030□	67	98.5	30	80	90	70h7	3	8	7	14h6	16	5	5	3
R7M-AP40030□	87	118.5	40	120	145	110h7	3.5	10	10	16h6	22			
R7M-AP75030□	86.5	120												

R7M-AP□□□30-S1-D (Without brake)

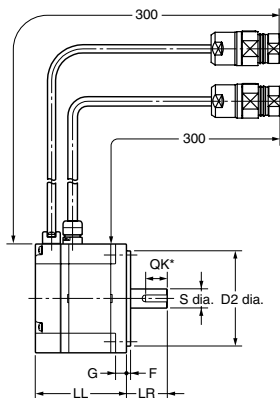

R7M-AP□□□30-BS1-D (With brake)

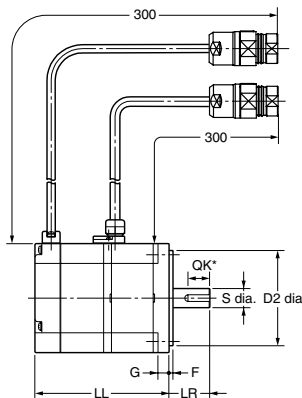

Axis end dimensions

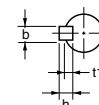

Four, Z-dia. mounting holes

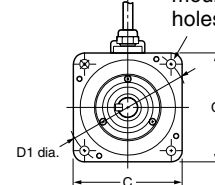

Ordering information

(Refer to servo drive chapter)

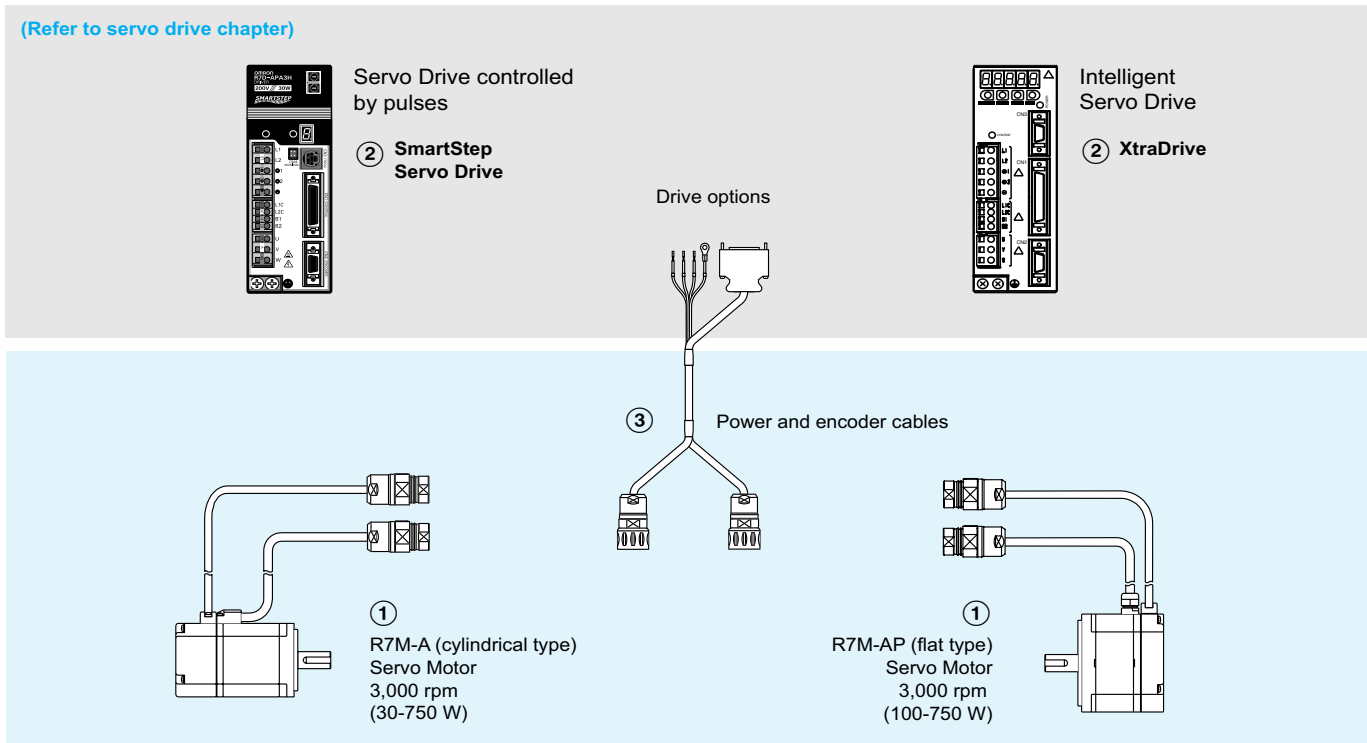

Note: The symbols ①②③... show the recommended sequence to select the servo motor and cables.

Servo motor

Cylindrical servo motors (3,000-r/min)

Symbol	Specifications			Servo motor model	Compatible servo drives ②		
	Design	Rated torque	Capacity		SmartStep	XtraDrive	
①	Cylindrical servo motors (3,000-r/min) Straight shaft with key	Without brake	0.095 Nm	30 W	R7M-A03030-S1-D	R7D-APA3H	XD-P3-MN01
			0.159 Nm	50 W	R7M-A05030-S1-D	R7D-APA5H	XD-P5-MN01
			0.318 Nm	100 W	R7M-A10030-S1-D	R7D-AP01H	XD-01-MN01
			0.637 Nm	200 W	R7M-A20030-S1-D	R7D-AP02H	XD-02-MN01
			1.27 Nm	400 W	R7M-A40030-S1-D	R7D-AP04H	XD-04-MN01
			2.39 Nm	750 W	R7M-A75030-S1-D	R7D-AP08H	XD-08-MN
	With brake	0.095 Nm	30 W	R7M-A03030-BS1-D	R7D-APA3H	XD-P3-MN01	
		0.159 Nm	50 W	R7M-A05030-BS1-D	R7D-APA5H	XD-P5-MN01	
		0.318 Nm	100 W	R7M-A10030-BS1-D	R7D-AP01H	XD-01-MN01	
		0.637 Nm	200 W	R7M-A20030-BS1-D	R7D-AP02H	XD-02-MN01	
		1.27 Nm	400 W	R7M-A40030-BS1-D	R7D-AP04H	XD-04-MN01	
		2.39 Nm	750 W	R7M-A75030-BS1-D	R7D-AP08H	XD-08-MN	

Flat servo motors (3,000-r/min)

Symbol	Specifications			Servo motor model	Compatible servo drives ②		
	Design	Rated torque	Capacity		SmartStep	XtraDrive	
①	Flat servo motors (3,000-r/min) Straight shaft with key	Without brake	0.318 Nm	100 W	R7M-AP10030-S1-D	R7D-AP01H	XD-01-MN01
			0.637 Nm	200 W	R7M-AP20030-S1-D	R7D-AP02H	XD-02-MN01
			1.27 Nm	400 W	R7M-AP40030-S1-D	R7D-AP04H	XD-04-MN01
			2.39 Nm	750 W	R7M-AP75030-S1-D	R7D-AP08H	XD-08-MN
		With brake	0.318 Nm	100 W	R7M-AP10030-BS1-D	R7D-AP01H	XD-01-MN01
			0.637 Nm	200 W	R7M-AP20030-BS1-D	R7D-AP02H	XD-02-MN01
			1.27 Nm	400 W	R7M-AP40030-BS1-D	R7D-AP04H	XD-04-MN01
			2.39 Nm	750 W	R7M-AP75030-BS1-D	R7D-AP08H	XD-08-MN

Servo drive

Note: Choosing SmartStep drive or XtraDrive affects to the encoder cable needed.

② Refer to SmartStep servo drive or XtraDrive chapter for detailed drive specifications and selection of drive accessories.

Servo motor cables for SmartStep drive

Standard cable (power + encoder)

Symbol	Drive	Specifications	Power cable model	Encoder cable model	Appearance
③	SmartStep	For servo motors without brake R7M-A(P)□□□30-S1-D	3 m	R7A-CEA003S-DE	
			5 m	R7A-CEA005S-DE	
			10 m	R7A-CEA010S-DE	
			15 m	R7A-CEA015S-DE	
			20 m	R7A-CEA020S-DE	
		For servo motors with brake R7M-A(P)□□□30-BS1-D	3 m	R7A-CEA003B-DE	
			5 m	R7A-CEA005B-DE	
			10 m	R7A-CEA010B-DE	
			15 m	R7A-CEA015B-DE	
			20 m	R7A-CEA020B-DE	

Flexible cables (power + encoder)

Symbol	Drive	Specifications	Power cable model	Encoder cable model	Appearance	
③	SmartStep	For servo motors without brake R7M-A(P)□□□30-S1-D	3 m	R88A-CAWA003S-DE	R7A-CRA003-FDE	
			5 m	R88A-CAWA005S-DE	R7A-CRA005-FDE	
			10 m	R88A-CAWA010S-DE	R7A-CRA010-FDE	
			15 m	R88A-CAWA015S-DE	R7A-CRA015-FDE	
			20 m	R88A-CAWA020S-DE	R7A-CRA020-FDE	
		For servo motors with brake R7M-A(P)□□□30-BS1-D	3 m	R88A-CAWA003B-DE	R7A-CRA003-FDE	
			5 m	R88A-CAWA005B-DE	R7A-CRA005-FDE	
			10 m	R88A-CAWA010B-DE	R7A-CRA010-FDE	
			15 m	R88A-CAWA015B-DE	R7A-CRA015-FDE	
			20 m	R88A-CAWA020B-DE	R7A-CRA020-FDE	

Servo motor cables for XtraDrive Drive

Flexible cables (power + encoder)

Symbol	Drive	Specifications	Power cable model	Encoder cable model	Appearance	
③	XtraDrive	For servo motors without brake R7M-A(P)□□□30-S1-D	3 m	R88A-CAWA003S-DE	XD-CRA003-DE	
			5 m	R88A-CAWA005S-DE	XD-CRA005-DE	
			10 m	R88A-CAWA010S-DE	XD-CRA010-DE	
			15 m	R88A-CAWA015S-DE	XD-CRA015-DE	
			20 m	R88A-CAWA020S-DE	XD-CRA020-DE	
		For servo motors with brake R7M-A(P)□□□30-BS1-D	3 m	R88A-CAWA003B-DE	XD-CRA003-DE	
			5 m	R88A-CAWA005B-DE	XD-CRA005-DE	
			10 m	R88A-CAWA010B-DE	XD-CRA010-DE	
			15 m	R88A-CAWA015B-DE	XD-CRA015-DE	
			20 m	R88A-CAWA020B-DE	XD-CRA020-DE	

Connectors

Specifications	Model
SmartStep connectors kit	Models included in kit
SmartStep encoder connector (for CN2)	R7A-CNA01R
Hypertac power connector female	SPOC-06K-FSDN169
Hypertac encoder connector female	SPOC-17H-FRON169
Hypertac power connector male (used in the motor)	SRUC-06J-MSCN236
Hypertac encoder connector male (used in the motor)	SRUC-17G-MRWN087

ALL DIMENSIONS SHOWN ARE IN MILLIMETERS.
To convert millimeters into inches, multiply by 0.03937. To convert grams into ounces, multiply by 0.03527.