

阅读申明

- 1.本站收集的数据手册和产品资料都来自互联网，版权归原作者所有。如读者和版权方有任何异议请及时告之，我们将妥善解决。
- 2.本站提供的中文数据手册是英文数据手册的中文翻译，其目的是协助用户阅读，该译文无法自动跟随原稿更新，同时也可能存在翻译上的不当。建议读者以英文原稿为参考以便获得更精准的信息。
- 3.本站提供的产品资料，来自厂商的技术支持或者使用者的心得体会等，其内容可能存在描述上的差异，建议读者做出适当判断。
- 4.如需与我们联系，请发邮件到marketing@iczoom.com，主题请标有“数据手册”字样。

Read Statement

1. The datasheets and other product information on the site are all from network reference or other public materials, and the copyright belongs to the original author and original published source. If readers and copyright owners have any objections, please contact us and we will deal with it in a timely manner.
2. The Chinese datasheets provided on the website is a Chinese translation of the English datasheets. Its purpose is for reader's learning exchange only and do not involve commercial purposes. The translation cannot be automatically updated with the original manuscript, and there may also be improper translations. Readers are advised to use the English manuscript as a reference for more accurate information.
3. All product information provided on the website refer to solutions from manufacturers' technical support or users the contents may have differences in description, and readers are advised to take the original article as the standard.
4. If you have any questions, please contact us at marketing@iczoom.com and mark the subject with "Datasheets" .

R7M-A□, R7M-AP□

SmartStep servo motors

The smart alternative to stepper motors

- SmartStep motors can be controlled by SmartStep drive and XtraDrive
- Cylindrical and flat servo motor types are available
- Easy to setup, easy to operate. SmartStep is as easy to use as a stepper motor
- Front-panel switches in the SmartStep drive make settings easy and eliminate the need for time-consuming parameter settings
- Extended features and embedded in drive control can be provided using intelligent XtraDrive
- Models with brake available
- Easy to connect to the drive using prebuilt cables



Ratings

- 230 VAC from 30 W to 750 W
(0.095 Nm to 2.39 Nm)

System configuration

(Refer to servo drive chapter)



Servo Drive controlled by pulses

SmartStep Servo Drive

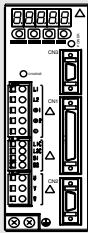

Intelligent Servo Drive
XtraDrive

Drive options

Power and encoder cables

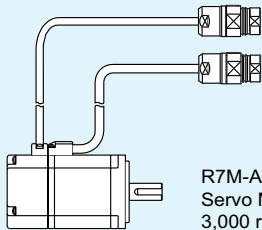

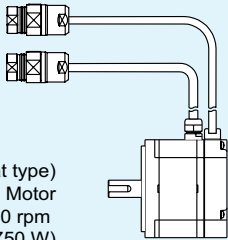
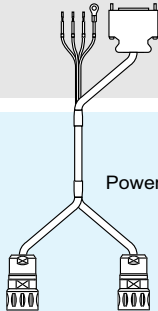

R7M-A (cylindrical type)
Servo Motor
3,000 rpm
(30-750 W)



R7M-AP (flat type)
Servo Motor
3,000 rpm
(100-750 W)

Servo motor / servo drive combination

| SmarStep servo motor | | | | | SmartStep servo drive | XtraDrive servo drive |
|--|---------|--------------|----------|---------------|-----------------------|-----------------------|
| | Voltage | Rated torque | Capacity | Model | 230 V (1-phase) | 230 V (1-phase) |
|  R7M-A (3000 min ⁻¹) | 230 V | 0.095 Nm | 30 W | R7M-A03030-□ | R7D-APA3H | XD-P3-MN01 |
| | | 0.159 Nm | 50 W | R7M-A05030-□ | R7D-APA5H | XD-P5-MN01 |
| | | 0.318 Nm | 100 W | R7M-A10030-□ | R7D-AP01H | XD-01-MN01 |
| | | 0.637 Nm | 200 W | R7M-A20030-□ | R7D-AP02H | XD-02-MN01 |
| | | 1.27 Nm | 400 W | R7M-A40030-□ | R7D-AP04H | XD-04-MN01 |
| | | 2.39 Nm | 750 W | R7M-A75030-□ | R7D-AP08H | XD-08-MN |
|  R7M-AP(3000 min ⁻¹) | 230 V | 0.318 Nm | 100 W | R7M-AP10030-□ | R7D-AP01H | XD-01-MN01 |
| | | 0.637 Nm | 200 W | R7M-AP20030-□ | R7D-AP02H | XD-02-MN01 |
| | | 1.27 Nm | 400 W | R7M-AP40030-□ | R7D-AP04H | XD-04-MN01 |
| | | 2.39 Nm | 750 W | R7M-AP75030-□ | R7D-AP08H | XD-08-MN |

Note: 1. For servo motor and cable part numbers, refer to ordering information at the end of this chapter.
 2. Refer to the servo drive chapter for drive options selection and detailed specifications.

Servo motor specifications

General specifications

| Item | Specification |
|-------------------------------|---|
| Ambient operating temperature | 0 to 40 °C |
| Ambient operating humidity | 20% to 80% (with no condensation) |
| Ambient storage temperature | -20 to 60 °C |
| Ambient storage humidity | 20% to 80% (with no condensation) |
| Storage/operating atmosphere | No corrosive gases. |
| Vibration resistance | 10 to 2,500 Hz in X, Y, and Z directions with 0.2 mm double amplitude or acceleration of 24.5 m/s ² max., whichever is smaller |
| Impact resistance | Acceleration 98 m/s ² max., in a vertical direction, two times |
| Insulation resistance | Between power line terminals and FG: 10 MΩ min. (at 500 VDC) |
| Dielectric strength | Between power line terminals and FG: 1,500 VAC for 1 min at 50/60 Hz |
| Run position | Any direction |
| Insulation grade | Type B |
| Structure | Totally-enclosed self-cooling |
| Protective structure | IP55 for both the cylindrical and flat servo motors |
| Vibration grade | V-15 |
| Mounting method | Flange-mounting |
| International standards | Approval obtained for UL, cUL, and EN (EMC directive and low-voltage directive) |

Performance specifications

Flat servo motors

| Item | R7M-AP10030-□ | R7M-AP20030-□ | R7M-AP40030-□ | R7M-AP75030-□ | |
|----------------------------------|---|---|---|---|--------------|
| Rated output | 100 W | 200 W | 400 W | 750 W | |
| Rated torque | 0.318 N·m | 0.637 N·m | 1.27 N·m | 2.39 N·m | |
| Rated rotation speed | 3,000 r/min | 3,000 r/min | 3,000 r/min | 3,000 r/min | |
| Momentary maximum rotation speed | 4,500 r/min | 4,500 r/min | 4,500 r/min | 4,500 r/min | |
| Momentary maximum torque | 0.96 N·m | 1.91 N·m | 3.82 N·m | 7.1 N·m | |
| Rated current | 0.89 A (rms) | 2.0 A (rms) | 2.6 A (rms) | 4.1 A (rms) | |
| Momentary maximum current | 2.8 A (rms) | 6.0 A (rms) | 8.0 A (rms) | 13.9 A (rms) | |
| Rotor inertia | 6.5 × 10 ⁻⁶ kg·m ² | 2.09 × 10 ⁻⁵ kg·m ² | 3.47 × 10 ⁻⁵ kg·m ² | 2.11 × 10 ⁻⁴ kg·m ² | |
| Power rate | 15.7 kW/s | 19.4 kW/s | 46.8 kW/s | 26.9 kW/s | |
| Allowable radial load | 78 N | 245 N | 245 N | 392 N | |
| Allowable thrust load | 49 N | 68 N | 68 N | 147 N | |
| Weight | Without brake | 0.7 kg | 1.4 kg | 2.1 kg | |
| | With brake | 0.9 kg | 1.9 kg | 2.6 kg | |
| Encoder resolution | 2,000 pulses/revolution for phase-A and phase-B, 1 pulse/revolution for phase-Z | | | | |
| Radiation shield dimensions | t6 × 250 mm square | | | t12 × 300 mm square | |
| Brake specifications | Brake inertia | 3.1 × 10 ⁻⁶ kg·m ² | 1.52 × 10 ⁻⁵ kg·m ² | 1.52 × 10 ⁻⁵ kg·m ² | |
| | Excitation voltage | 24 VDC ±10% | | | |
| | Power consumption (at 20 °C) | 7.5 W | 7.6 W | 8.2 W | 7.5 W |
| | Current consumption (at 20 °C) | 0.31 A | 0.32 A | 0.34 A | 0.31 A |
| | Static friction torque | 0.4 N·m min. | 0.9 N·m min. | 1.9 N·m min. | 3.5 N·m min. |
| | Attraction time | 60 ms max. | 40 ms max. | 60 ms max. | 20 ms max. |
| | Release time | 20 ms max. | 20 ms max. | 20 ms max. | 40 ms max. |
| | Backlash | 1° | 1° | 1° | 1° |
| | Rating | Continuous | | | |
| | Insulation grade | Type F | | | |
| Applicable servo driver (R7D-) | AP01H | AP02H | AP04H | AP08H | |

Cylindrical servo motors

| Item | R7M-A03030-□ | R7M-A05030-□ | R7M-A10030-□ | R7M-A20030-□ | R7M-A40030-□ | R7M-A75030-□ | |
|----------------------------------|---|---|---|---|---|---|--|
| Rated output | 30 W | 50 W | 100 W | 200 W | 400 W | 750 W | |
| Rated torque | 0.095 N·m | 0.159 N·m | 0.318 N·m | 0.637 N·m | 1.27 N·m | 2.39 N·m | |
| Rated rotation speed | 3,000 r/min | 3,000 r/min | 3,000 r/min | 3,000 r/min | 3,000 r/min | 3,000 r/min | |
| Momentary maximum rotation speed | 4,500 r/min | 4,500 r/min | 4,500 r/min | 4,500 r/min | 4,500 r/min | 4,500 r/min | |
| Momentary maximum torque | 0.29 N·m | 0.48 N·m | 0.96 N·m | 1.91 N·m | 3.82 N·m | 7.1 N·m | |
| Rated current | 0.42 A (rms) | 0.6 A (rms) | 0.87 A (rms) | 2.0 A (rms) | 2.6 A (rms) | 4.4 A (rms) | |
| Momentary maximum current | 1.3 A (rms) | 1.9 A (rms) | 2.8 A (rms) | 6.0 A (rms) | 8.0 A (rms) | 13.9 A (rms) | |
| Rotor inertia | 1.7×10^{-6} kg·m ² | 2.2×10^{-6} kg·m ² | 3.6×10^{-6} kg·m ² | 1.19×10^{-5} kg·m ² | 1.87×10^{-5} kg·m ² | 6.67×10^{-5} kg·m ² | |
| Power rate | 5.31 kW/s | 11.5 kW/s | 28.1 kW/s | 34.1 kW/s | 86.3 kW/s | 85.6 kW/s | |
| Allowable radial load | 68 N | 68 N | 78 N | 245 N | 245 N | 392 N | |
| Allowable thrust load | 54 N | 54 N | 54 N | 74 N | 74 N | 147 N | |
| Weight | Without brake | 0.3 kg | 0.4 kg | 0.5 kg | 1.1 kg | 1.7 kg | 3.4 kg |
| | With brake | 0.6 kg | 0.7 kg | 0.8 kg | 1.6 kg | 2.2 kg | 4.3 kg |
| Encoder resolution | 2,000 pulses/revolution for phase-A and phase-B, 1 pulse/revolution for phase-Z | | | | | | |
| Radiation shield dimensions | t6 × 250 mm square | | | | | | |
| Brake specifications | Brake inertia | 0.85×10^{-6} kg·m ² | 0.85×10^{-6} kg·m ² | 0.85×10^{-6} kg·m ² | 6.4×10^{-6} kg·m ² | 6.4×10^{-6} kg·m ² | 1.7×10^{-5} kg·m ² |
| | Excitation voltage | 24 VDC ±10% V | | | | | |
| | Power consumption (at 20 °C) | 6 W | 6 W | 6 W | 7 W | 7 W | 7.7 W |
| | Current consumption (at 20 °C) | 0.25 A | 0.25 A | 0.25 A | 0.29 A | 0.29 A | 0.32 A |
| | Static friction torque | 0.2 N·m min. | 0.2 N·m min. | 0.34 N·m min. | 1.47 N·m min. | 1.47 N·m min. | 2.45 N·m min. |
| | Attraction time | 30 ms max. | 30 ms max. | 30 ms max. | 60 ms max. | 60 ms max. | 60 ms max. |
| | Release time | 60 ms max. | 60 ms max. | 60 ms max. | 20 ms max. | 20 ms max. | 20 ms max. |
| | Backlash | 1° | 1° | 1° | 1° | 1° | 1° |
| Rating | Continuous | | | | | | |
| Insulation grade | Type F | | | | | | |
| Applicable servo driver (R7D-) | APA3H | APA5H | AP01H | AP02H | AP04H | AP08H | |

Torque and rotation speed characteristics

Flat servo motors

The following graphs show the characteristics with a 3 m standard cable and R7D-AP□H servo driver (200 VAC input)

R7M-AP10030 (100 W)

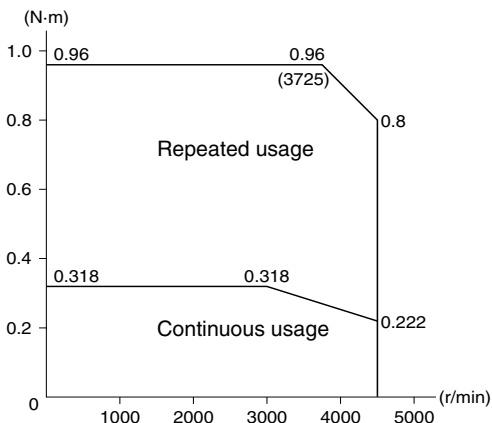

R7M-AP20030 (200 W)

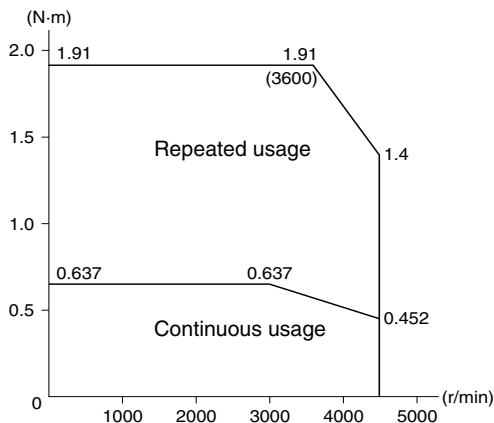

R7M-AP40030 (400 W)

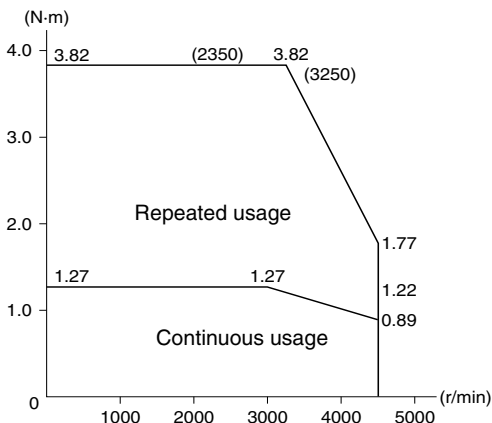

R7M-AP75030 (750 W)

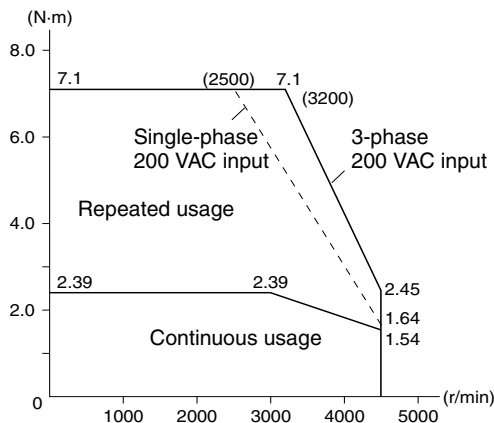

Torque and rotation speed characteristics

Cylindrical servo motors

The following graphs show the characteristics with a 3 m standard cable and an R7D-AP□H servo driver (200 VAC input.)

R7M-A03030 (30 W)

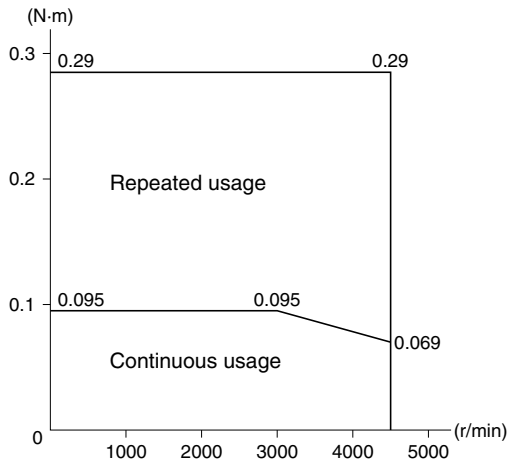

R7M-A05030 (50 W)

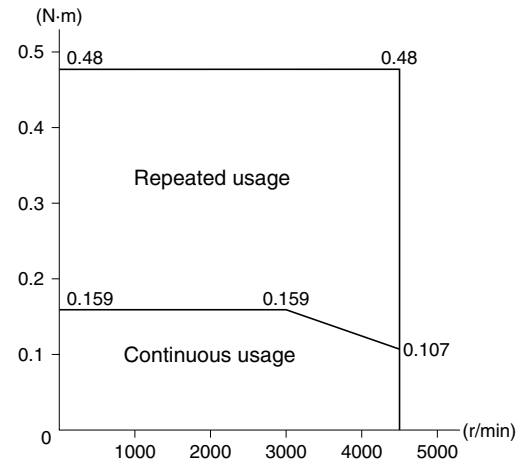

R7M-A10030 (100 W)

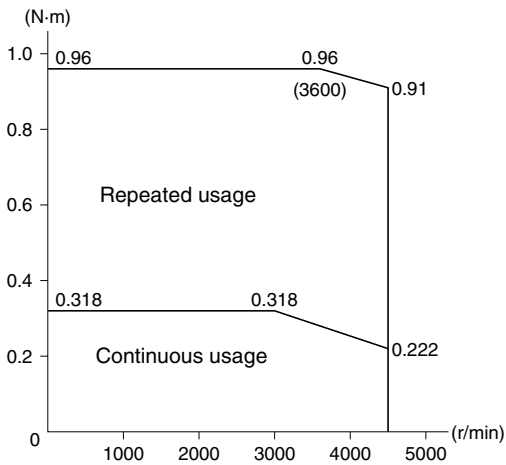

R7M-A20030 (200 W)

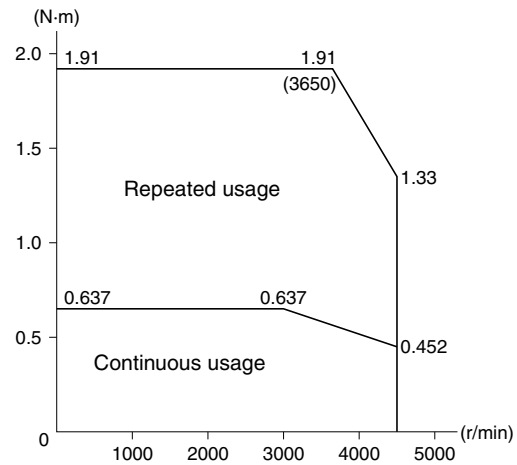

R7M-A40030 (400 W)

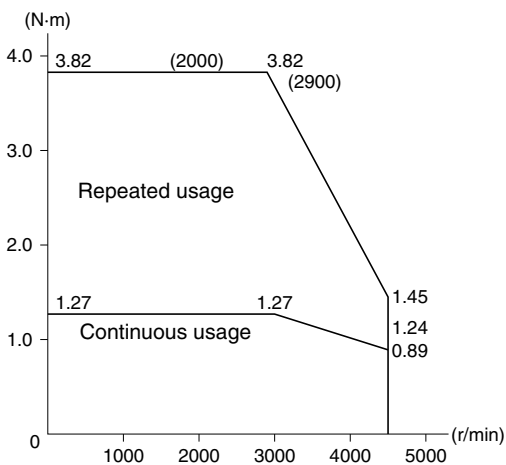

R7M-A75030 (750 W)

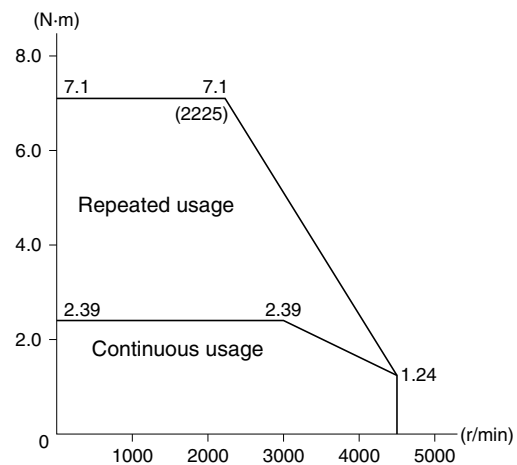

Dimensions

Cylindrical servo motors (3,000 r/min)
200 VAC: 30W/50W/100W/200W/400W/750W

Without brake: R7M-A03030-S1-D/A05030-S1-D/A10030-S1-D/A20030-S1-D/A40030-S1-D/A75030-S1-D
With brake: R7M-A03030-BS1-D/A05030-BS1-D/A10030-BS1-D/A20030-BS1-D/A40030-BS1-D/A75030-BS1-D

| Model | Dimensions (mm) | | | | | | | | | | | | | | |
|-------------|-----------------|------------|----|----------------|-----|-------|------|----|---------------|----------------|------|----|----|-----|-----|
| | LL | | LR | Flange surface | | | | | | Axis end | | | | | |
| | Without brake | With brake | | C | D1 | D2 | F | G | Z | S | QK | b | h | t1 | |
| R7M-A03030□ | 69.5 | 101 | 25 | 40 | 46 | 30h7 | 2.5 | 5 | Two, 4.3 dia. | 6h6 | 14 | 2 | 2 | 1.2 | |
| R7M-A05030□ | 77 | 108.5 | | 30 | 60 | 70 | 50h7 | 3 | 6 | Four, 5.5 dia. | 8h6 | 20 | 3 | 3 | 1.8 |
| R7M-A10030□ | 94.5 | 135 | | | 80 | 90 | 70h7 | 3 | 8 | Four, 7 dia. | 14h6 | | 30 | 5 | 5 |
| R7M-A20030□ | 96.5 | 136 | 40 | 80 | 90 | 70h7 | 3 | 8 | Four, 7 dia. | 14h6 | 30 | 5 | 5 | 3 | |
| R7M-A40030□ | 124.5 | 164 | | 120 | 145 | 110h7 | 3.5 | 10 | 10 | 16h6 | 22 | 5 | 5 | 3 | |
| R7M-A75030□ | 145 | 189.5 | 40 | 80 | 90 | 70h7 | 3 | 8 | Four, 7 dia. | 16h6 | 30 | 5 | 5 | 3 | |

R7M-A□□□30-S1-D (Without brake)

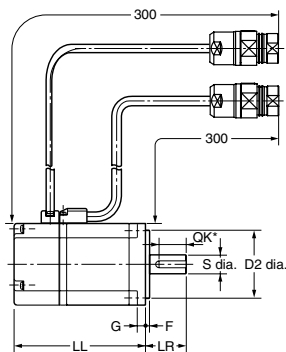

R7M-A□□□30-BS1-D (With brake)

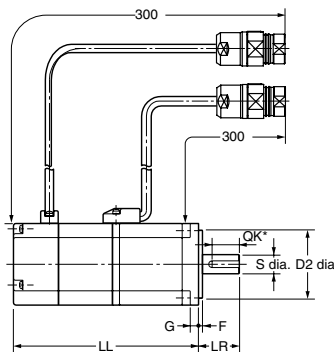

Axis end dimensions

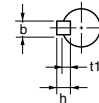

Hole with "Z" mark

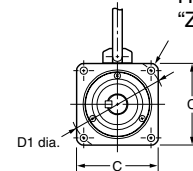

Flat servo motors (3,000 r/min)
200 VAC: 100W/200W/400W/750W

Without brake: R7M-AP10030-S1-D/AP20030-S1-D/AP40030-S1-D/AP75030-S1-D
With brake: R7M-AP10030-BS1-D/AP20030-BS1-D/AP40030-BS1-D/AP75030-BS1-D

| Model | Dimensions (mm) | | | | | | | | | | | | | |
|--------------|-----------------|------------|----|----------------|-----|-------|-----|----|-----|----------|----|---|---|-----|
| | LL | | LR | Flange surface | | | | | | Axis End | | | | |
| | Without brake | With brake | | C | D1 | D2 | F | G | Z | S | QK | b | h | t1 |
| R7M-AP10030□ | 62 | 91 | 25 | 60 | 70 | 50h7 | 3 | 6 | 5.5 | 8h6 | 14 | 3 | 3 | 1.8 |
| R7M-AP20030□ | 67 | 98.5 | 30 | 80 | 90 | 70h7 | 3 | 8 | 7 | 14h6 | 16 | 5 | 5 | 3 |
| R7M-AP40030□ | 87 | 118.5 | 40 | 120 | 145 | 110h7 | 3.5 | 10 | 10 | 16h6 | 22 | 5 | 5 | 3 |
| R7M-AP75030□ | 86.5 | 120 | | 120 | 145 | 110h7 | 3.5 | 10 | 10 | 16h6 | 22 | | | |

R7M-AP□□□30-S1-D (Without brake)

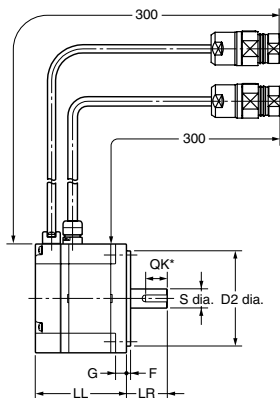

R7M-AP□□□30-BS1-D (With brake)

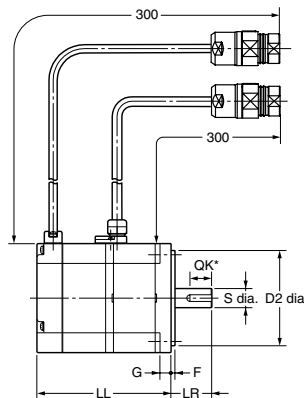

Axis end dimensions

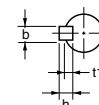

Four, Z-dia. mounting holes

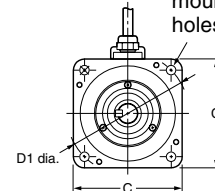

Ordering information

(Refer to servo drive chapter)

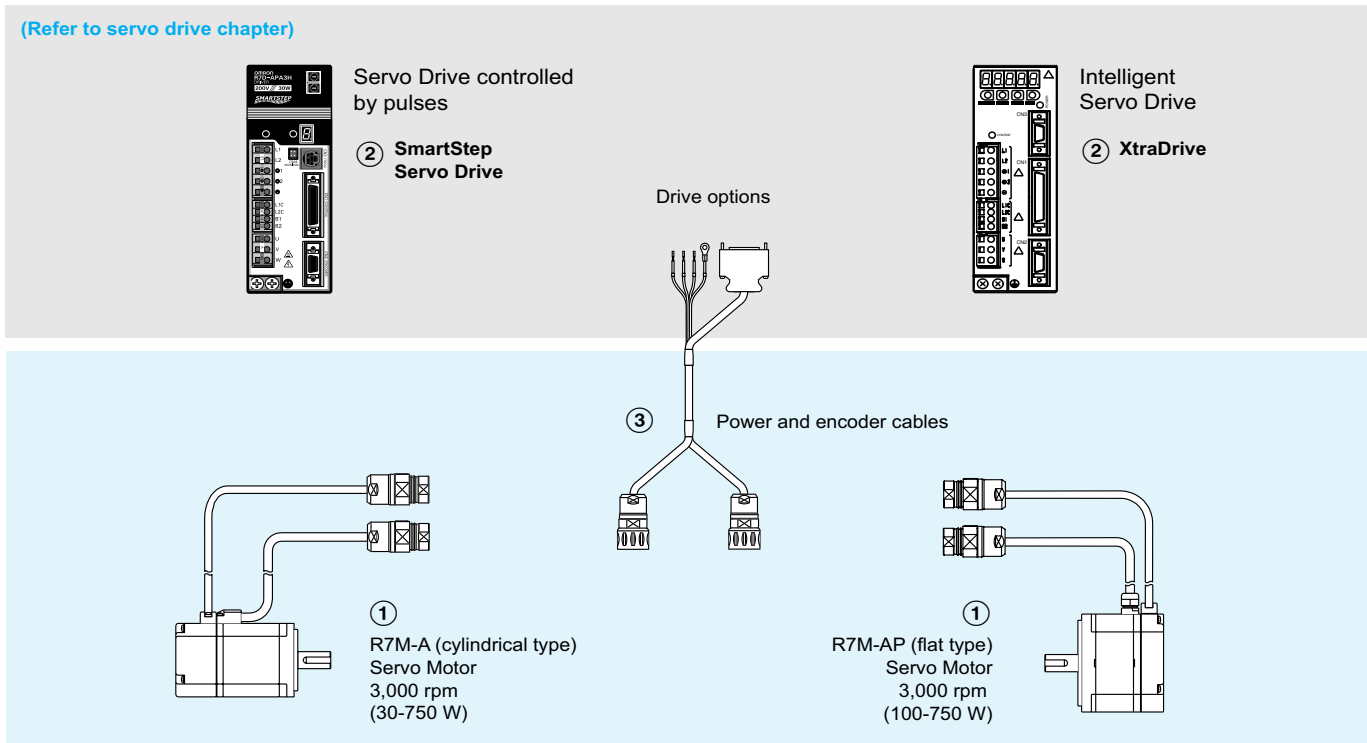

Note: The symbols ①②③... show the recommended sequence to select the servo motor and cables.

Servo motor

Cylindrical servo motors (3,000-r/min)

| Symbol | Specifications | | | Servo motor model | Compatible servo drives ② | | |
|--------|---|---------------|----------|-------------------|---------------------------|-----------|------------|
| | Design | Rated torque | Capacity | | SmartStep | XtraDrive | |
| ① | Cylindrical servo motors (3,000-r/min) Straight shaft with key | Without brake | 0.095 Nm | 30 W | R7M-A03030-S1-D | R7D-APA3H | XD-P3-MN01 |
| | | | 0.159 Nm | 50 W | R7M-A05030-S1-D | R7D-APA5H | XD-P5-MN01 |
| | | | 0.318 Nm | 100 W | R7M-A10030-S1-D | R7D-AP01H | XD-01-MN01 |
| | | | 0.637 Nm | 200 W | R7M-A20030-S1-D | R7D-AP02H | XD-02-MN01 |
| | | | 1.27 Nm | 400 W | R7M-A40030-S1-D | R7D-AP04H | XD-04-MN01 |
| | | | 2.39 Nm | 750 W | R7M-A75030-S1-D | R7D-AP08H | XD-08-MN |
| | | With brake | 0.095 Nm | 30 W | R7M-A03030-BS1-D | R7D-APA3H | XD-P3-MN01 |
| | | | 0.159 Nm | 50 W | R7M-A05030-BS1-D | R7D-APA5H | XD-P5-MN01 |
| | | | 0.318 Nm | 100 W | R7M-A10030-BS1-D | R7D-AP01H | XD-01-MN01 |
| | | | 0.637 Nm | 200 W | R7M-A20030-BS1-D | R7D-AP02H | XD-02-MN01 |
| | | | 1.27 Nm | 400 W | R7M-A40030-BS1-D | R7D-AP04H | XD-04-MN01 |
| | | | 2.39 Nm | 750 W | R7M-A75030-BS1-D | R7D-AP08H | XD-08-MN |

Flat servo motors (3,000-r/min)

| Symbol | Specifications | | | Servo motor model | Compatible servo drives ② | | |
|--------|--|---------------|----------|-------------------|---------------------------|-----------|------------|
| | Design | Rated torque | Capacity | | SmartStep | XtraDrive | |
| ① | Flat servo motors (3,000-r/min) Straight shaft with key | Without brake | 0.318 Nm | 100 W | R7M-AP10030-S1-D | R7D-AP01H | XD-01-MN01 |
| | | | 0.637 Nm | 200 W | R7M-AP20030-S1-D | R7D-AP02H | XD-02-MN01 |
| | | | 1.27 Nm | 400 W | R7M-AP40030-S1-D | R7D-AP04H | XD-04-MN01 |
| | | | 2.39 Nm | 750 W | R7M-AP75030-S1-D | R7D-AP08H | XD-08-MN |
| | | With brake | 0.318 Nm | 100 W | R7M-AP10030-BS1-D | R7D-AP01H | XD-01-MN01 |
| | | | 0.637 Nm | 200 W | R7M-AP20030-BS1-D | R7D-AP02H | XD-02-MN01 |
| | | | 1.27 Nm | 400 W | R7M-AP40030-BS1-D | R7D-AP04H | XD-04-MN01 |
| | | | 2.39 Nm | 750 W | R7M-AP75030-BS1-D | R7D-AP08H | XD-08-MN |

Servo drive

Note: Choosing SmartStep drive or XtraDrive affects to the encoder cable needed.

② Refer to SmartStep servo drive or XtraDrive chapter for detailed drive specifications and selection of drive accessories.

Servo motor cables for SmartStep drive

Standard cable (power + encoder)

| Symbol | Drive | Specifications | Power cable model | Encoder cable model | Appearance |
|--------|-----------|--|-------------------|---------------------|------------|
| ③ | SmartStep | For servo motors without brake R7M-A(P)□□□30-S1-D | 3 m | R7A-CEA003S-DE | |
| | | | 5 m | R7A-CEA005S-DE | |
| | | | 10 m | R7A-CEA010S-DE | |
| | | | 15 m | R7A-CEA015S-DE | |
| | | | 20 m | R7A-CEA020S-DE | |
| | | For servo motors with brake R7M-A(P)□□□30-BS1-D | 3 m | R7A-CEA003B-DE | |
| | | | 5 m | R7A-CEA005B-DE | |
| | | | 10 m | R7A-CEA010B-DE | |
| | | | 15 m | R7A-CEA015B-DE | |
| | | | 20 m | R7A-CEA020B-DE | |

Flexible cables (power + encoder)

| Symbol | Drive | Specifications | Power cable model | Encoder cable model | Appearance | |
|--------|-----------|--|-------------------|---------------------|----------------|--|
| ③ | SmartStep | For servo motors without brake R7M-A(P)□□□30-S1-D | 3 m | R88A-CAWA003S-DE | R7A-CRA003-FDE | |
| | | | 5 m | R88A-CAWA005S-DE | R7A-CRA005-FDE | |
| | | | 10 m | R88A-CAWA010S-DE | R7A-CRA010-FDE | |
| | | | 15 m | R88A-CAWA015S-DE | R7A-CRA015-FDE | |
| | | | 20 m | R88A-CAWA020S-DE | R7A-CRA020-FDE | |
| | | For servo motors with brake R7M-A(P)□□□30-BS1-D | 3 m | R88A-CAWA003B-DE | R7A-CRA003-FDE | |
| | | | 5 m | R88A-CAWA005B-DE | R7A-CRA005-FDE | |
| | | | 10 m | R88A-CAWA010B-DE | R7A-CRA010-FDE | |
| | | | 15 m | R88A-CAWA015B-DE | R7A-CRA015-FDE | |
| | | | 20 m | R88A-CAWA020B-DE | R7A-CRA020-FDE | |

Servo motor cables for XtraDrive Drive

Flexible cables (power + encoder)

| Symbol | Drive | Specifications | Power cable model | Encoder cable model | Appearance | |
|--------|-----------|--|-------------------|---------------------|--------------|--|
| ③ | XtraDrive | For servo motors without brake R7M-A(P)□□□30-S1-D | 3 m | R88A-CAWA003S-DE | XD-CRA003-DE | |
| | | | 5 m | R88A-CAWA005S-DE | XD-CRA005-DE | |
| | | | 10 m | R88A-CAWA010S-DE | XD-CRA010-DE | |
| | | | 15 m | R88A-CAWA015S-DE | XD-CRA015-DE | |
| | | | 20 m | R88A-CAWA020S-DE | XD-CRA020-DE | |
| | | For servo motors with brake R7M-A(P)□□□30-BS1-D | 3 m | R88A-CAWA003B-DE | XD-CRA003-DE | |
| | | | 5 m | R88A-CAWA005B-DE | XD-CRA005-DE | |
| | | | 10 m | R88A-CAWA010B-DE | XD-CRA010-DE | |
| | | | 15 m | R88A-CAWA015B-DE | XD-CRA015-DE | |
| | | | 20 m | R88A-CAWA020B-DE | XD-CRA020-DE | |

Connectors

| Specifications | Model |
|---|------------------------|
| SmartStep connectors kit | Models included in kit |
| SmartStep encoder connector (for CN2) | R7A-CNA01R |
| Hypertac power connector female | SPOC-06K-FSDN169 |
| Hypertac encoder connector female | SPOC-17H-FRON169 |
| Hypertac power connector male (used in the motor) | SRUC-06J-MSCN236 |
| Hypertac encoder connector male (used in the motor) | SRUC-17G-MRWN087 |

ALL DIMENSIONS SHOWN ARE IN MILLIMETERS.
To convert millimeters into inches, multiply by 0.03937. To convert grams into ounces, multiply by 0.03527.