

阅读申明

- 1.本站收集的数据手册和产品资料都来自互联网，版权归原作者所有。如读者和版权方有任何异议请及时告之，我们将妥善解决。
- 2.本站提供的中文数据手册是英文数据手册的中文翻译，其目的是协助用户阅读，该译文无法自动跟随原稿更新，同时也可能存在翻译上的不当。建议读者以英文原稿为参考以便获得更精准的信息。
- 3.本站提供的产品资料，来自厂商的技术支持或者使用者的心得体会等，其内容可能存在描述上的差异，建议读者做出适当判断。
- 4.如需与我们联系，请发邮件到marketing@iczoom.com，主题请标有“数据手册”字样。

Read Statement

1. The datasheets and other product information on the site are all from network reference or other public materials, and the copyright belongs to the original author and original published source. If readers and copyright owners have any objections, please contact us and we will deal with it in a timely manner.
2. The Chinese datasheets provided on the website is a Chinese translation of the English datasheets. Its purpose is for reader's learning exchange only and do not involve commercial purposes. The translation cannot be automatically updated with the original manuscript, and there may also be improper translations. Readers are advised to use the English manuscript as a reference for more accurate information.
3. All product information provided on the website refer to solutions from manufacturers' technical support or users the contents may have differences in description, and readers are advised to take the original article as the standard.
4. If you have any questions, please contact us at marketing@iczoom.com and mark the subject with "Datasheets" .

FEATURES

- * 0.4 inch (10.0 mm) DIGIT HEIGHT.
- * CONTINUOUS UNIFORM SEGMENTS.
- * LOW POWER REQUIREMENT.
- * EXCELLENT CHARACTERS APPEARANCE.
- * HIGH BRIGHTNESS & HIGH CONTRAST.
- * WIDE VIEWING ANGLE.
- * SOLID STATE RELIABILITY.
- * CATEGORIZED FOR LUMINOUS INTENSITY.

DESCRIPTION

The LTD-4608JR is a 0.4 inch (10.0 mm) digit height dual digit seven-segment display. This device utilizes AllnGaP Super Red LED chips, which are made from AllnGaP on a non-transparent GaAs substrate, and has a gray face and white segments.

DEVICE

| PART NO. | DESCRIPTION |
|-------------------|---------------------|
| AllnGaP Super Red | Duplex Common Anode |
| LTD-4608JR | Rt. Hand Decimal |

PACKAGE DIMENSIONS

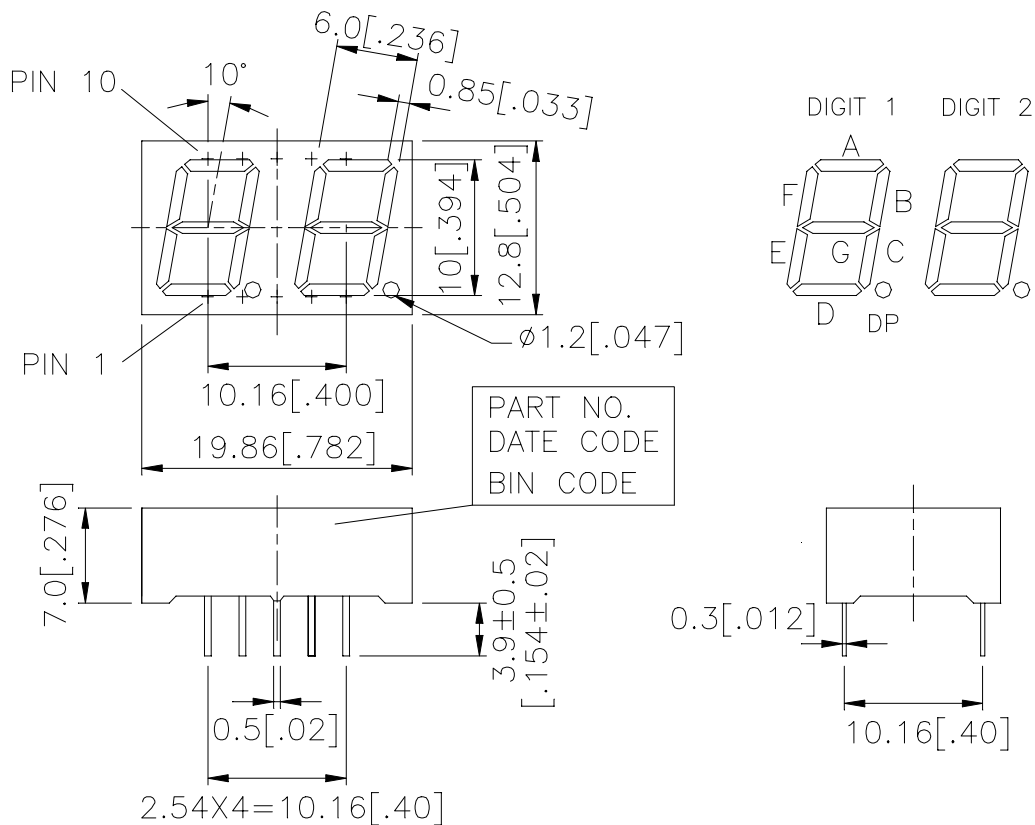

NOTES: All dimensions are in millimeters. Tolerances are ± 0.25 mm (0.01") unless otherwise noted.

INTERNAL CIRCUIT DIAGRAM

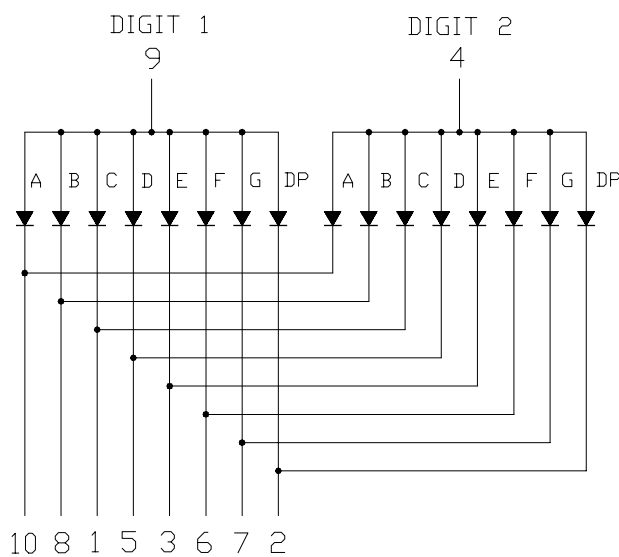

PIN CONNECTION

| No | CONNECTION |
|-----------|------------------------|
| 1 | CATHODE C |
| 2 | CATHODE D.P. |
| 3 | CATHODE E |
| 4 | COMMON ANODE (DIGIT 2) |
| 5 | CATHODE D |
| 6 | CATHODE F |
| 7 | CATHODE G |
| 8 | CATHODE B |
| 9 | COMMON ANODE (DIGIT 1) |
| 10 | CATHODE A |

ABSOLUTE MAXIMUM RATING AT Ta=25°C

| PARAMETER | MAXIMUM RATING | UNIT |
|--|-----------------|-------|
| Power Dissipation Per Segment | 70 | mW |
| Peak Forward Current Per Segment (1/10 Duty Cycle, 0.1ms Pulse Width) | 90 | mA |
| Continuous Forward Current Per Segment | 25 | mA |
| Derating Linear From 25°C Per Segment | 0.28 | mA/°C |
| Reverse Voltage Per Segment | 5 | V |
| Operating Temperature Range | -35°C to +105°C | |
| Storage Temperature Range | -35°C to +105°C | |
| Solder Temperature: max 260°C for max 3sec at 1.6mm below seating plane. | | |

ELECTRICAL / OPTICAL CHARACTERISTICS AT Ta=25°C

| PARAMETER | SYMBOL | MIN. | TYP. | MAX. | UNIT | TEST CONDITION |
|-----------------------------------|-------------------|------|------|------|------|----------------------|
| Average Luminous Intensity | I _v | 320 | 850 | | μcd | I _F =1mA |
| Peak Emission Wavelength | λ _p | | 639 | | nm | I _F =20mA |
| Spectral Line Half-Width | Δλ | | 20 | | nm | I _F =20mA |
| Dominant Wavelength | λ _d | | 631 | | nm | I _F =20mA |
| Forward Voltage Per Segment | V _F | | 2 | 2.6 | V | I _F =20mA |
| Reverse Current Per Segment | I _R | | | 100 | μA | V _R =5V |
| Luminous Intensity Matching Ratio | I _v -m | | | 2:1 | | I _F =1mA |

Note: Luminous intensity is measured with a light sensor and filter combination that approximates the CIE (Commision Internationale De L'Eclairage) eye-response curve.

TYPICAL ELECTRICAL / OPTICAL CHARACTERISTIC CURVES

(25°C Ambient Temperature Unless Otherwise Noted)

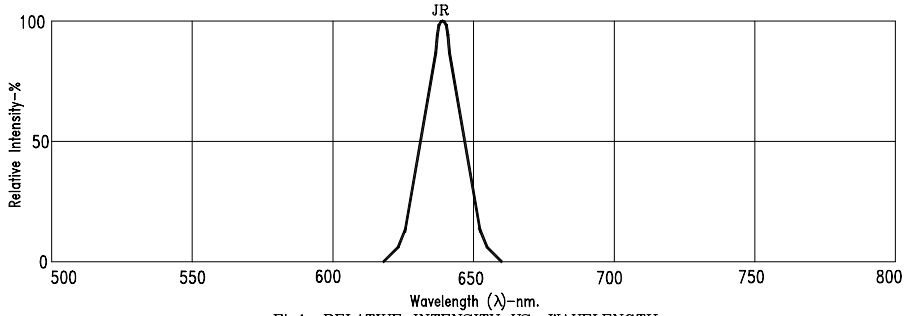

Fig1. RELATIVE INTENSITY VS. WAVELENGTH

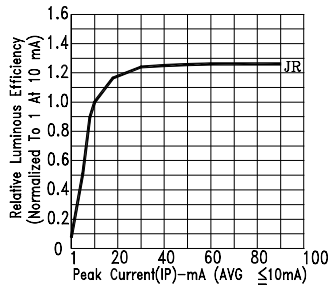

Fig2. RELATIVE LUMINOUS EFFICIENCY (LUMINOUS INTENSITY PER UNIT CURRENT) VS. PEAK CURRENT

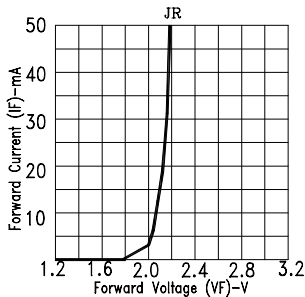

Fig3. FORWARD CURRENT VS. FORWARD VOLTAGE

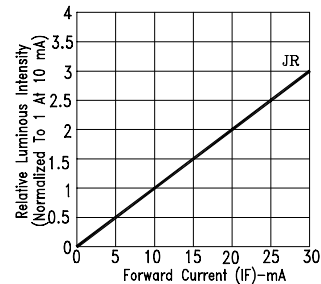

Fig4. RELATIVE LUMINOUS INTENSITY VS. FORWARD CURRENT

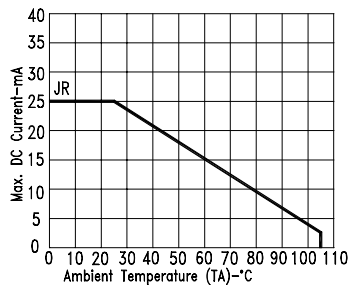

Fig5. MAX. ALLOWABLE DC CURRENT VS. AMBIENT TEMPERATURE.

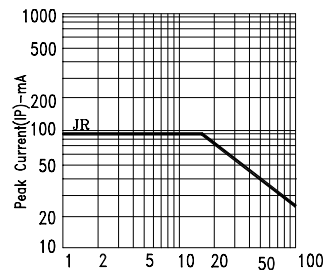

Fig6. MAX. PEAK CURRENT VS. DUTY CYCLE % (REFRESH RATE 1KHz)

NOTE : JR=AlInGaP SUPER RED