

## 阅读申明

- 1.本站收集的数据手册和产品资料都来自互联网，版权归原作者所有。如读者和版权方有任何异议请及时告之，我们将妥善解决。
- 2.本站提供的中文数据手册是英文数据手册的中文翻译，其目的是协助用户阅读，该译文无法自动跟随原稿更新，同时也可能存在翻译上的不当。建议读者以英文原稿为参考以便获得更精准的信息。
- 3.本站提供的产品资料，来自厂商的技术支持或者使用者的心得体会等，其内容可能存在描述上的差异，建议读者做出适当判断。
- 4.如需与我们联系，请发邮件到marketing@iczoom.com，主题请标有“数据手册”字样。

## Read Statement

1. The datasheets and other product information on the site are all from network reference or other public materials, and the copyright belongs to the original author and original published source. If readers and copyright owners have any objections, please contact us and we will deal with it in a timely manner.
2. The Chinese datasheets provided on the website is a Chinese translation of the English datasheets. Its purpose is for reader's learning exchange only and do not involve commercial purposes. The translation cannot be automatically updated with the original manuscript, and there may also be improper translations. Readers are advised to use the English manuscript as a reference for more accurate information.
3. All product information provided on the website refer to solutions from manufacturers' technical support or users the contents may have differences in description, and readers are advised to take the original article as the standard.
4. If you have any questions, please contact us at marketing@iczoom.com and mark the subject with "Datasheets" .



RoHS compliant

### FEATURES

- 1. Small size, Low height**  
L: 31 mm × W: 16 mm × H: 9 mm L: 1.220 inch × W: .630 inch × H: .354 inch
- 2. Low Insertion Loss**  
Achieved 1dB max. insertion loss (Typ. 0.5dB)
- 3. Non-latching and latching types available.**
- 4. Conforms to Telcordia GR-1221-core**  
Everything is produced under one roof from internal mechanical relays to optical

products. We ensure high reliability by harnessing our powerful production technology that has been cultivated over many years.

### APPLICATIONS

- Optical ADM equipment
- Protection switching (WDM, CATV, FTTH)
- Optical measuring instrument

### ORDERING INFORMATION

AWAP						
WA Optical Switch						
Switch type						
0: 1 × 2						
1: 2 × 2						
Fiber type and wavelength						
	Wavelength	1310 nm	1550 nm	1310/1550 nm		
Fiber type						
Single mode (9/125/900)		0	1	2		
	Wavelength	850 nm	1310 nm	850/1310 nm		
Fiber type						
Multi mode (50/125/900)		3	4	5		
Multi mode (62.5/125/900)		6	7	8		
Operation type						
0: Non-latching type						
1: 1-coil latching type						
2: 2-coil latching type						
Connector type (For other connector types, please contact us.)						
Connector type	SC/AdPC	MU/AdPC				
	2	3				
Nominal operating voltage						
1: 3 VDC						
6: 4.5 VDC						
9: 5 VDC						

### TYPES

#### 1. 1 × 2 type (single mode)

Wavelength	Nominal operating voltage	Non-latching type		1-coil latching type		2-coil latching type	
		SC/AdPC connector	MU/AdPC connector	SC/AdPC connector	MU/AdPC connector	SC/AdPC connector	MU/AdPC connector
1310±20nm	3V	AWAP00021	AWAP00031	AWAP00121	AWAP00131	AWAP00221	AWAP00231
	4.5V	AWAP00026	AWAP00036	AWAP00126	AWAP00136	AWAP00226	AWAP00236
	5V	AWAP00029	AWAP00039	AWAP00129	AWAP00139	AWAP00229	AWAP00239
1550±20nm	3V	AWAP01021	AWAP01031	AWAP01121	AWAP01131	AWAP01221	AWAP01231
	4.5V	AWAP01026	AWAP01036	AWAP01126	AWAP01136	AWAP01226	AWAP01236
	5V	AWAP01029	AWAP01039	AWAP01129	AWAP01139	AWAP01229	AWAP01239
1310/1550nm	3V	AWAP02021	AWAP02031	AWAP02121	AWAP02131	AWAP02221	AWAP02231
	4.5V	AWAP02026	AWAP02036	AWAP02126	AWAP02136	AWAP02226	AWAP02236
	5V	AWAP02029	AWAP02039	AWAP02129	AWAP02139	AWAP02229	AWAP02239

Standard packing; Inner carton: 1 pcs., Outer case: 1 pcs.

# WA (AWAP)

## 2. 1 × 2 type (multi mode)

Fiber type	Wavelength	Nominal operating voltage	Non-latching type		1-coil latching type		2-coil latching type	
			SC/AdPC connector	MU/AdPC connector	SC/AdPC connector	MU/AdPC connector	SC/AdPC connector	MU/AdPC connector
Multi mode (50/125/900)	850±20nm	3V	AWAP03021	AWAP03031	AWAP03121	AWAP03131	AWAP03221	AWAP03231
		4.5V	AWAP03026	AWAP03036	AWAP03126	AWAP03136	AWAP03226	AWAP03236
		5V	AWAP03029	AWAP03039	AWAP03129	AWAP03139	AWAP03229	AWAP03239
	1310±20nm	3V	AWAP04021	AWAP04031	AWAP04121	AWAP04131	AWAP04221	AWAP04231
		4.5V	AWAP04026	AWAP04036	AWAP04126	AWAP04136	AWAP04226	AWAP04236
		5V	AWAP04029	AWAP04039	AWAP04129	AWAP04139	AWAP04229	AWAP04239
	850/1310nm	3V	AWAP05021	AWAP05031	AWAP05121	AWAP05131	AWAP05221	AWAP05231
		4.5V	AWAP05026	AWAP05036	AWAP05126	AWAP05136	AWAP05226	AWAP05236
		5V	AWAP05029	AWAP05039	AWAP05129	AWAP05139	AWAP05229	AWAP05239
Multi mode (62.5/125/900)	850±20nm	3V	AWAP06021	AWAP06031	AWAP06121	AWAP06131	AWAP06221	AWAP06231
		4.5V	AWAP06026	AWAP06036	AWAP06126	AWAP06136	AWAP06226	AWAP06236
		5V	AWAP06029	AWAP06039	AWAP06129	AWAP06139	AWAP06229	AWAP06239
	1310±20nm	3V	AWAP07021	AWAP07031	AWAP07121	AWAP07131	AWAP07221	AWAP07231
		4.5V	AWAP07026	AWAP07036	AWAP07126	AWAP07136	AWAP07226	AWAP07236
		5V	AWAP07029	AWAP07039	AWAP07129	AWAP07139	AWAP07229	AWAP07239
	850/1310nm	3V	AWAP08021	AWAP08031	AWAP08121	AWAP08131	AWAP08221	AWAP08231
		4.5V	AWAP08026	AWAP08036	AWAP08126	AWAP08136	AWAP08226	AWAP08236
		5V	AWAP08029	AWAP08039	AWAP08129	AWAP08139	AWAP08229	AWAP08239

Standard packing; Inner carton: 1 pcs., Outer case: 1 pcs.

## 3. 2 × 2 type (single mode)

Wavelength	Nominal operating voltage	Non-latching type		1-coil latching type		2-coil latching type	
		SC/AdPC connector	MU/AdPC connector	SC/AdPC connector	MU/AdPC connector	SC/AdPC connector	MU/AdPC connector
1310±20nm	3V	AWAP10021	AWAP10031	AWAP10121	AWAP10131	AWAP10221	AWAP10231
	4.5V	AWAP10026	AWAP10036	AWAP10126	AWAP10136	AWAP10226	AWAP10236
	5V	AWAP10029	AWAP10039	AWAP10129	AWAP10139	AWAP10229	AWAP10239
1550±20nm	3V	AWAP11021	AWAP11031	AWAP11121	AWAP11131	AWAP11221	AWAP11231
	4.5V	AWAP11026	AWAP11036	AWAP11126	AWAP11136	AWAP11226	AWAP11236
	5V	AWAP11029	AWAP11039	AWAP11129	AWAP11139	AWAP11229	AWAP11239
1310/1550nm	3V	AWAP12021	AWAP12031	AWAP12121	AWAP12131	AWAP12221	AWAP12231
	4.5V	AWAP12026	AWAP12036	AWAP12126	AWAP12136	AWAP12226	AWAP12236
	5V	AWAP12029	AWAP12039	AWAP12129	AWAP12139	AWAP12229	AWAP12239

Standard packing; Inner carton: 1 pcs., Outer case: 1 pcs.

## 4. 2 × 2 type (multi mode)

Fiber type	Wavelength	Nominal operating voltage	Non-latching type		1-coil latching type		2-coil latching type	
			SC/AdPC connector	MU/AdPC connector	SC/AdPC connector	MU/AdPC connector	SC/AdPC connector	MU/AdPC connector
Multi mode (50/125/900)	850±20nm	3V	AWAP13021	AWAP13031	AWAP13121	AWAP13131	AWAP13221	AWAP13231
		4.5V	AWAP13026	AWAP13036	AWAP13126	AWAP13136	AWAP13226	AWAP13236
		5V	AWAP13029	AWAP13039	AWAP13129	AWAP13139	AWAP13229	AWAP13239
	1310±20nm	3V	AWAP14021	AWAP14031	AWAP14121	AWAP14131	AWAP14221	AWAP14231
		4.5V	AWAP14026	AWAP14036	AWAP14126	AWAP14136	AWAP14226	AWAP14236
		5V	AWAP14029	AWAP14039	AWAP14129	AWAP14139	AWAP14229	AWAP14239
	850/1310nm	3V	AWAP15021	AWAP15031	AWAP15121	AWAP15131	AWAP15221	AWAP15231
		4.5V	AWAP15026	AWAP15036	AWAP15126	AWAP15136	AWAP15226	AWAP15236
		5V	AWAP15029	AWAP15039	AWAP15129	AWAP15139	AWAP15229	AWAP15239
Multi mode (62.5/125/900)	850±20nm	3V	AWAP16021	AWAP16031	AWAP16121	AWAP16131	AWAP16221	AWAP16231
		4.5V	AWAP16026	AWAP16036	AWAP16126	AWAP16136	AWAP16226	AWAP16236
		5V	AWAP16029	AWAP16039	AWAP16129	AWAP16139	AWAP16229	AWAP16239
	1310±20nm	3V	AWAP17021	AWAP17031	AWAP17121	AWAP17131	AWAP17221	AWAP17231
		4.5V	AWAP17026	AWAP17036	AWAP17126	AWAP17136	AWAP17226	AWAP17236
		5V	AWAP17029	AWAP17039	AWAP17129	AWAP17139	AWAP17229	AWAP17239
	850/1310nm	3V	AWAP18021	AWAP18031	AWAP18121	AWAP18131	AWAP18221	AWAP18231
		4.5V	AWAP18026	AWAP18036	AWAP18126	AWAP18136	AWAP18226	AWAP18236
		5V	AWAP18029	AWAP18039	AWAP18129	AWAP18139	AWAP18229	AWAP18239

Standard packing; Inner carton: 1 pcs., Outer case: 1 pcs.

Note: For other connector types, please contact us.

## RATING

### 1. Coil data (at 20°C 68°F)

Drive type	Nominal operating voltage	Nominal operating current (±10%)	Coil resistance (±10%)	Nominal operating power	Max. applied voltage
Non-latching type	3 V DC	83.3 mA	36Ω	250 mW	130% V DC of the nominal operating voltage
	4.5 V DC	55.5 mA	81Ω		
	5 V DC	50.0 mA	100Ω		
1-coil latching type	3 V DC	50.0 mA	60Ω	150 mW	
	4.5 V DC	33.3 mA	135Ω		
	5 V DC	30.0 mA	166.7Ω		
2-coil latching type	3 V DC	66.7 mA	45Ω	200 mW	
	4.5 V DC	44.4 mA	101.3Ω		
	5 V DC	40.0 mA	125Ω		

### 2. Specifications

Item		Specifications	
		Single mode	Multi mode
Optical characteristics	Insertion loss*1	Max. 1.0 dB	Max. 1.0 dB
	Isolation	Min. 60 dB	Min. 50 dB
	Return loss*1	Min. 50 dB	Min. 20 dB
	P.D.L.*1	Max. 0.1 dB	—
	Optical input power	Max. 100 mW (20 dBm)	Max. 100 mW (20 dBm)
Expected life	Mechanical life	Min. 10 <sup>7</sup> (at 20°C 68°F, at 180 cpm)	
Mechanical characteristics	Vibration resistance	Functional	10 to 55 Hz at double amplitude of 0.75 mm (Optical power fluctuation: Max. 1 dB)
		Destructive	10 to 55 Hz at double amplitude of 1.52 mm
	Shock resistance (Half-wave pulse of sine wave: 11 ms)	Functional	Non-latching type: Min. 100 m/s <sup>2</sup> (Optical power fluctuation: 1 dB or less) Latching type: Min. 200 m/s <sup>2</sup> (Optical power fluctuation: 1 dB or less)
		Destructive	Min. 500 m/s <sup>2</sup>
Electrical characteristics	Switching time (at 20°C 68°F)*2	Non-latching type: Max. 15 ms (Nominal applied operating voltage) Latching type: Max. 10 ms (Nominal applied operating voltage)	
Fiber tensile strength		450 g, Tension rate: 0.4 mm/sec, 1 min.	
Fiber flexural tensile strength		230 g, 5 sec., Tension direction 90° (perpendicular with fiber)	
Conditions	Conditions for operation, transport and storage	Ambient temperature -40 to +70°C -40 to +158°F, Humidity 5 to 85% R.H. (Not freezing and condensing at low temperature)	
Unit weight		Approx. 11 g .388 oz (Not including connector)	

Notes: 1. Without connectors' loss. Insertion loss is approx. 0.2 dB per connector. Return loss at connector parts is approx. 50 dB.  
2. Oscilloscope waveform of switching characteristic.

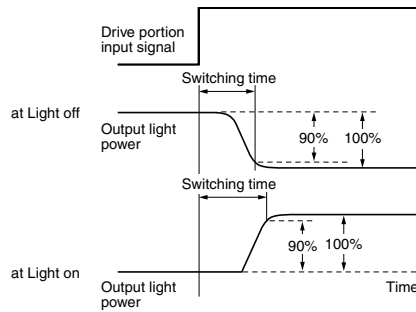

# WA (AWAP)

## DIMENSIONS (mm inch)

The CAD data of the products with a **CAD Data** mark can be downloaded from: <http://panasonic-electric-works.net/ac>

### 1. 1 × 2 type

**CAD Data**

#### External dimensions

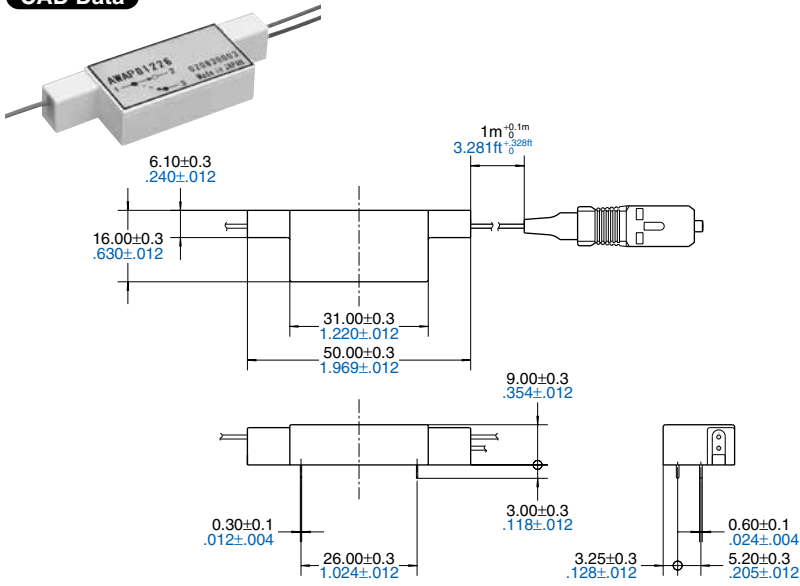

#### Optical signal I/O and coil impress direction indication diagram

1 × 2, Non-latching type

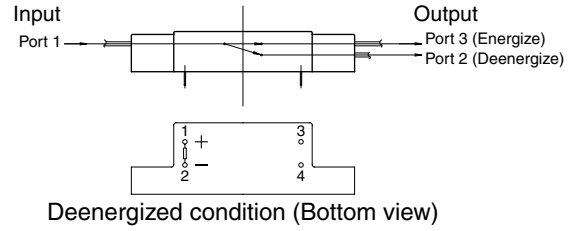

1 × 2, 1-coil latching type

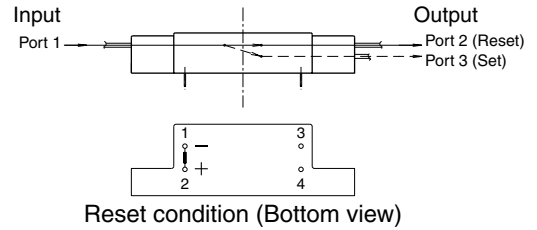

1 × 2, 2-coil latching type

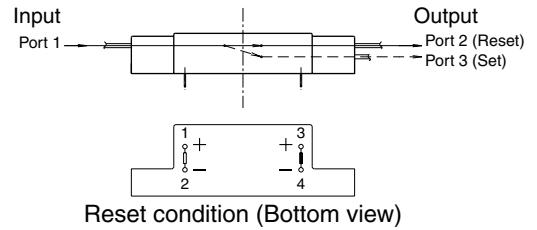

### 2. 2 × 2 type

**CAD Data**

#### External dimensions

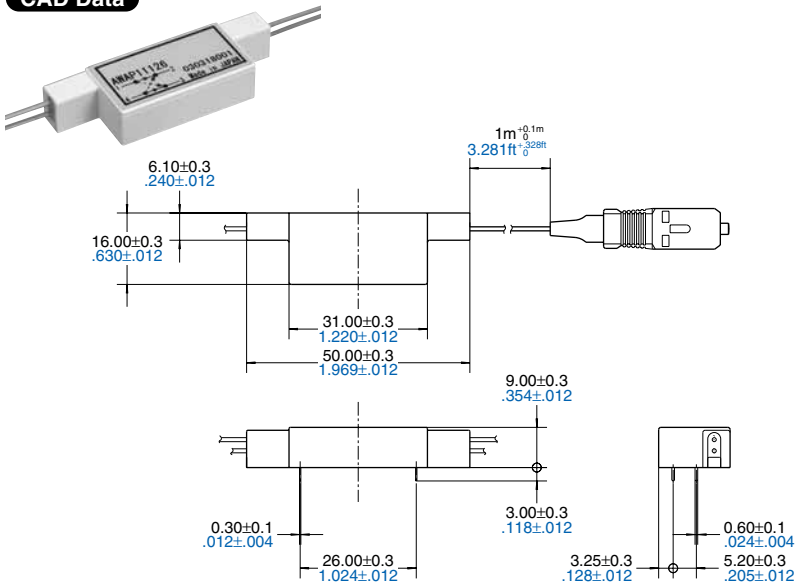

#### Optical signal I/O and coil impress direction indication diagram

2 × 2, Non-latching type

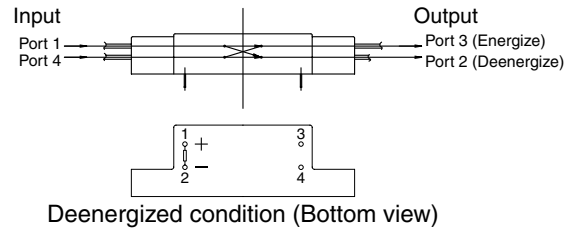

2 × 2, 1-coil latching type

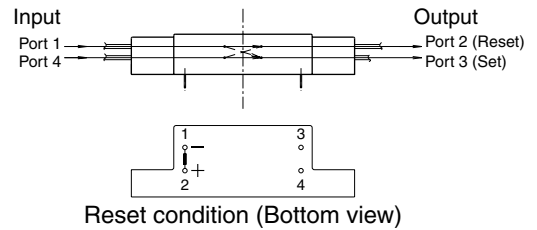

2 × 2, 2-coil latching type

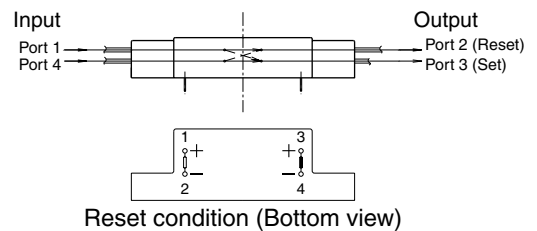

Reset (Deenergize)	Port 1 → Port 2 Port 4 → Port 3
Set (Energize)	Port 1 → Port 3 Port 4 → Port 2

PC board pattern

(Tolerance:  $\pm 0.1 \pm .004$ )

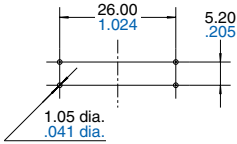

Nominal operating voltage applied method

	Terminal No.	Non-latching type	1- coil latching type	2- coil latching type
Set Energize	1	+V	+V	+V
	2	GND	GND	GND
	3	-	-	-
	4	-	-	-
Reset Deenergize	1	-	GND	-
	2	-	+V	-
	3	-	-	+V
	4	-	-	GND

NOTES

1. Operation, transport and storage conditions

- Temperature:  $-40$  to  $+70^{\circ}\text{C}$   $-40$  to  $+158^{\circ}\text{F}$
- Humidity: 5 to 85% RH (Avoid freezing and condensation.) The humidity range varies with the temperature. Use within the range indicated in the graph below.
- Atmospheric pressure: 86 to 106 kPa Temperature and humidity range for usage, transport, and storage

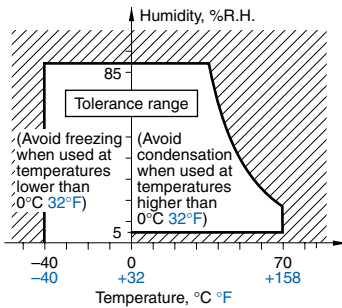

2. Solder and cleaning conditions

- Adhere to the conditions below when soldering this switch.
  - Solder iron tip temperature:  $400^{\circ}\text{C}$   $752^{\circ}\text{F}$  min.
  - Soldering iron: 60 to 100 W
  - Soldering time: within 5 seconds
 The effect on the switch will differ depending on the type of PC board used. For this reason, please verify using the actual PC board to be worked on.
- This switch cannot be washed.

3. Precautions for use

- Since this switch is polarized, reversing the coil + and - terminals will cause reverse operation. Be sure to connect following the attached product specification diagram.
- Keep the ripple rate of the nominal coil voltage below 5%.
- Avoid exceeding the specification ranges such as those for coil nominal voltage, contact rating and optical input power. Exceeding specifications can cause abnormal heating or deterioration of performance.

- For fiber, avoid bending to a radius smaller than 30 mm 1.181 inch as doing so can cause breakage.
- If a switch has been subjected to a strong shock such as dropping, do not use it.
- (Only latching type) Considering the possible change in ambient temperature and other conditions, it is recommended that the coil impress set and reset pulse width be at the nominal operation voltage and at least 20 ms to make certain of operation.
- (Only latching type) This switch is shipped from the factory in the reset state. A shock to the switch during shipping or installation may cause it to change to the set state. Therefore, it is recommended that the switch be used in a circuit which initializes it to the required state (set or reset) whenever the power is turned on.

For Cautions for Use, see Relay Technical Information.