

阅读申明

- 1.本站收集的数据手册和产品资料都来自互联网，版权归原作者所有。如读者和版权方有任何异议请及时告之，我们将妥善解决。
- 2.本站提供的中文数据手册是英文数据手册的中文翻译，其目的是协助用户阅读，该译文无法自动跟随原稿更新，同时也可能存在翻译上的不当。建议读者以英文原稿为参考以便获得更精准的信息。
- 3.本站提供的产品资料，来自厂商的技术支持或者使用者的心得体会等，其内容可能存在描述上的差异，建议读者做出适当判断。
- 4.如需与我们联系，请发邮件到marketing@iczoom.com，主题请标有“数据手册”字样。

Read Statement

1. The datasheets and other product information on the site are all from network reference or other public materials, and the copyright belongs to the original author and original published source. If readers and copyright owners have any objections, please contact us and we will deal with it in a timely manner.
2. The Chinese datasheets provided on the website is a Chinese translation of the English datasheets. Its purpose is for reader's learning exchange only and do not involve commercial purposes. The translation cannot be automatically updated with the original manuscript, and there may also be improper translations. Readers are advised to use the English manuscript as a reference for more accurate information.
3. All product information provided on the website refer to solutions from manufacturers' technical support or users the contents may have differences in description, and readers are advised to take the original article as the standard.
4. If you have any questions, please contact us at marketing@iczoom.com and mark the subject with "Datasheets" .

ASMT-Lx50

Flexible Light Strip Module



Data Sheet

Description

Flexible Light Strip Module is high performance light tube produced by Avago Technologies, integrating LEDs solution with excellent thermoplastic polyurethane. This Light Strip is an environmentally friendly "Green Material", it offers a unique combination of mechanical, physical, and chemical properties, including high tensile strength, excellent abrasion resistance, outstanding flexibility, weather resistance, non toxic, recyclable, and decomposable. Flexible Light Strip Module provides conveniences for the designers to integrate light strip onto their devices with minimum consideration on optical and mechanical optimization. The specially designed housing helps to concentrate the light for maximum efficiency and the specially designed PCB provides plug-and-play type of solution for assembly. The total solution provides the ease of design and assembly for designers.

Features

- Outstanding abrasion resistance
- Excellent mechanical properties
- Excellent chemical resistance
- Excellent light transitivity
- High shaping flexibility
- Available length 100mm to 500mm at interval of 1mm
- Available voltage source : 5V, 9V and 12V
- Available color: Blue, Green, Red and White
- Light strip module in circular configuration

Applications

- Handheld devices
- Cellular Phones
- Decorative lighting
- Electronics and electrical appliances

Package Dimensions

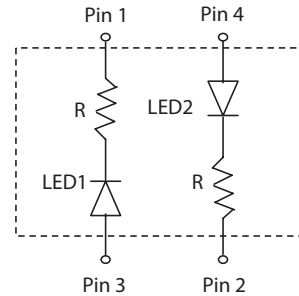
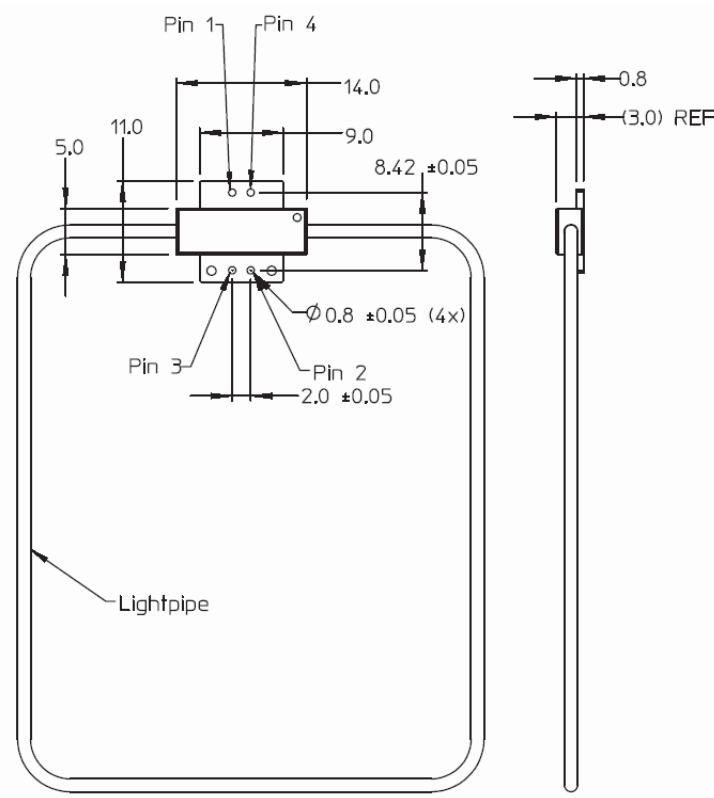

Pin 1	Ground for LED 1
Pin 2	Ground for LED 2
Pin 3	Vcc for LED 1
Pin 4	Vcc for LED 2

Flexible light strip length = 226mm
Standard Part Number = ASMT-Lx50

Notes:

1. All dimensions in millimeters (Inches).
2. Tolerances are $\pm 0.1\text{mm}$ [0.004 IN.] Unless otherwise specified.
3. Strip diameter $\phi 1.4\text{mm}$.

Part Numbering System for Other Available Options

ASMT - L x 50 - xxx x B

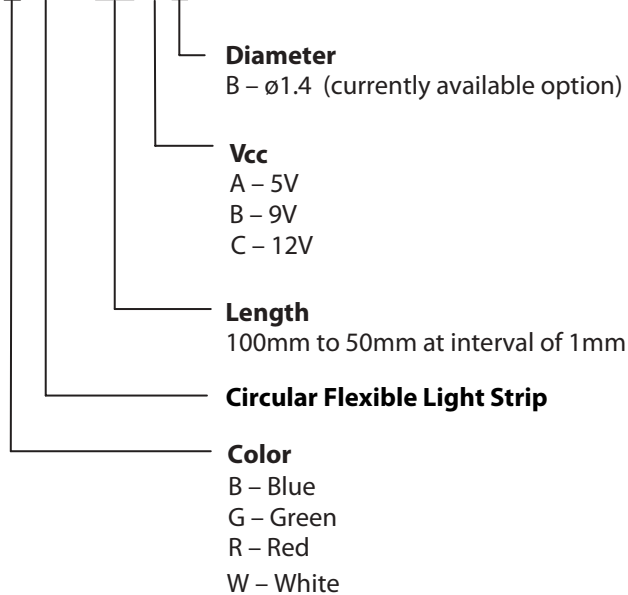

Recommended Connector

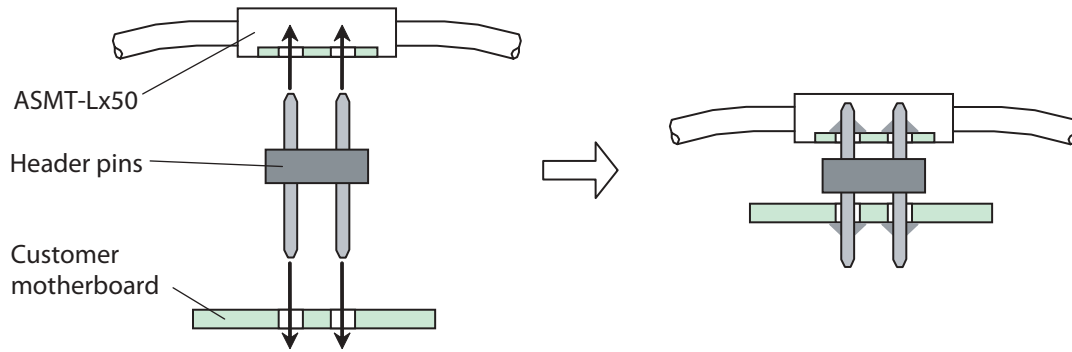

CAUTION: ASMT-Lx50 devices are Class 1 ESD sensitive. Please observe appropriate precautions during handling and processing. Refer to Avago Technologies Application Note AN-1142 for additional details.

Absolute Maximum Ratings at $T_A = 25^\circ\text{C}$

Parameter	ASMT-Lx50	Unit
DC Forward Current ^{[1] [2]}	30	mA
Power Dissipation ^{[2] [3]}	153	mW
Reverse Voltage ($I_R = 100 \text{ A}$) ^[2]	5	V
LED Junction Temperature	110	$^\circ\text{C}$
Operating Temperature Range	-30 to 60	$^\circ\text{C}$
Storage Temperature Range	-30 to 60	$^\circ\text{C}$
Manual Soldering Temperature	350 $^\circ\text{C}$ for 3 sec max	

Note:

1. Derate linearly as shown in Figure 4.
2. For each individual LED + resistor string.
3. $V_{cc} \text{ max} = 5.1\text{V}$.

Electrical Characteristics at $T_A = 25^\circ\text{C}$

Part Number	Voltage V_{cc} (Volts) ^[1]			LED Forward Current ^[1]
	Minimum	Typical	Maximum	I_F (mA) @ $V_{cc} = 5.0\text{V}$
ASMT-Lx50	4.9	5.0	5.1	20

Note:

1. For each individual LED + resistor string.
2. Resistor value is determined by forward voltage of LED.

Optical Characteristics at T_A = 25°C

Part Number	Luminous Intensity, I _v ^{[1][2]} (mcd) @ 20mA		Peak Wavelength, λ _{peak} ^[1] (nm)	Color, Dominant Wavelength λ _d ^{[1][3]} (nm)		Luminous Incidence ^[5] E _v (lm/m ²)
	Min.	Max.	Typ.	Min.	Max.	Typ.
ASMT-LB50	71.5	180.0	468	465	475	30.0
ASMT-LG50	180.0	450.0	520.0	515.0	535.0	130.0
ASMT-LR50	112.5	285.0	637.0	615.0	630.0	30.0

Part Number	Luminous Intensity, I _v ^{[1][2]} (mcd) @20mA		Typical Chromaticity Coordinates ^{[1][4]}		Luminous Incidence ^[5] E _v (lm/m ²)
	Min.	Max.	X	Y	Typ.
ASMT-LW50	1000	1600	0.31	0.31	230.0

Notes:

1. For individual LED light source only.
2. The luminous intensity I_v is measured at the peak of the spatial radiation pattern which may not be aligned with the mechanical axis of the LED package. Refer to I_v bin table for binning structure and tolerance.
3. The dominant wavelength, λ_d, is derived from the CIE 1931 Chromaticity Diagram and represents the perceived color of the device. Refer to color bin limit tables for binning structure and tolerance.
4. The chromaticity coordinates are derived from the CIE 1931 Chromaticity Diagram and represent the perceived color of the device. Refer to color bin limit tables for binning structure and tolerance.
5. Measurement done at the center of the elastomer light stripe away from the LED light sources.

Light Intensity (I_v) Bin Limits^{[1][2]}

Blue

Bin ID	Intensity (mcd)	
	Minimum	Maximum
Q	71.50	112.50
R	112.50	180.00

Tolerance: ±15%

Green

Bin ID	Intensity (mcd)	
	Minimum	Maximum
S	180.0	285.0
T	285.0	450.0

Tolerance: ±15%

Red

Bin ID	Intensity (mcd)	
	Minimum	Maximum
R	112.5	180.0
S	180.0	285.0

Tolerance: ±15%

White

Bin ID	Intensity (mcd)	
	Minimum	Maximum
W1	1000	1200
W2	1200	1400
W3	1400	1600

Tolerance: ±15%

Notes:

1. Bin categories are established for classification of products. Products may not be available in all categories. Please contact your Avago representative for information on current available bins.
2. For individual LED light source only.

Color Bin Limits ^[1] ^[2]

Blue

Bin ID	Dom. Wavelength (nm)	
	Minimum	Maximum
B	465.0	470.0
C	470.0	475.0

Tolerance: ±1.0nm

Green

Bin ID	Dom. Wavelength (nm)	
	Minimum	Maximum
A	515.0	520.0
B	520.0	525.0
C	525.0	530.0
D	530.0	535.0

Tolerance: ±1.0nm

Red

Bin ID	Dom. Wavelength (mcd)	
	Minimum	Maximum
-	615	630

Tolerance: ±1.0nm

White

Rank	Chromaticity Coordinates				
	C11	X	0.290	0.297	0.297
	Y	0.306	0.316	0.283	0.274
C12	X	0.297	0.303	0.303	0.297
	Y	0.316	0.326	0.293	0.283
C13	X	0.303	0.310	0.310	0.303
	Y	0.326	0.336	0.303	0.293
C21	X	0.290	0.297	0.297	0.290
	Y	0.274	0.283	0.251	0.241
C22	X	0.297	0.303	0.303	0.297
	Y	0.283	0.293	0.261	0.251
C23	X	0.303	0.310	0.310	0.297
	Y	0.293	0.303	0.271	0.251
D11	X	0.310	0.320	0.320	0.310
	Y	0.336	0.350	0.318	0.303
D12	X	0.320	0.330	0.330	0.320
	Y	0.350	0.365	0.333	0.318
D21	X	0.310	0.320	0.320	0.310
	Y	0.303	0.318	0.285	0.271
D22	X	0.320	0.330	0.330	0.320
	Y	0.318	0.333	0.300	0.285

Tolerance of each bin limit = ± 0.02

Notes:

1. Bin categories are established for classification of products. Products may not be available in all categories. Please contact your Avago representative for information on current available bins.
2. For individual LED light source only.

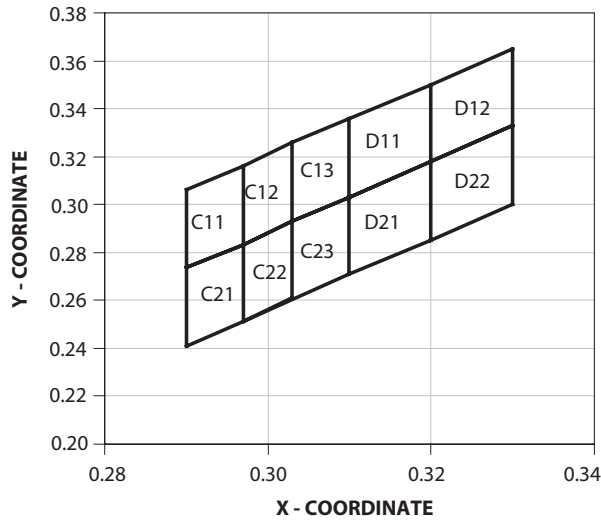

Figure 1. White binning in CIE 1931 Chromaticity Diagram.

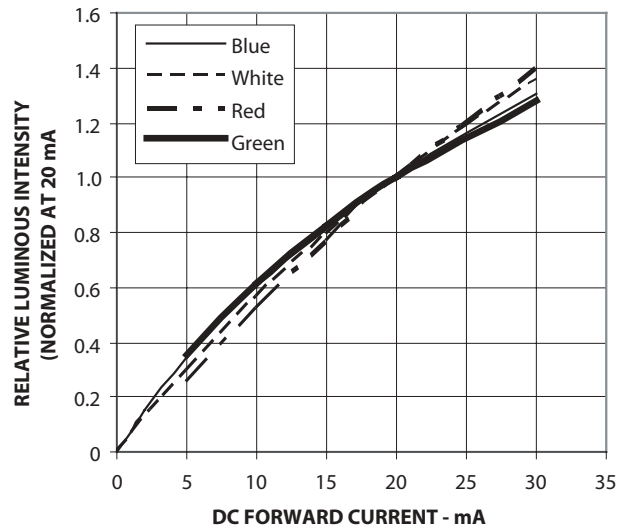

Figure 2. Relative luminous intensity vs. forward current for LED light sources only.

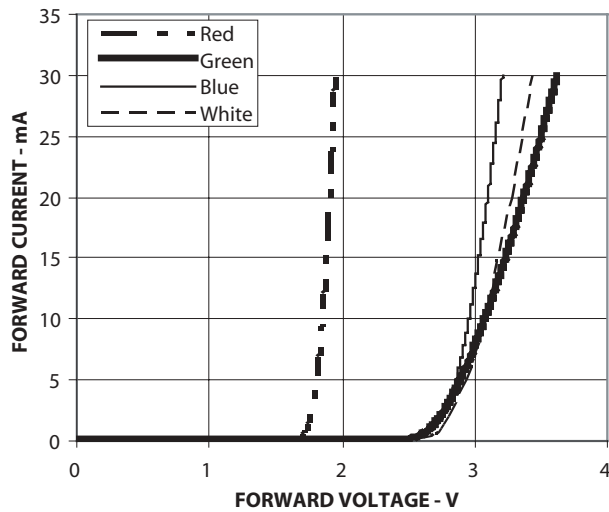

Figure 3. Forward voltage vs. forward current for LED light sources only.

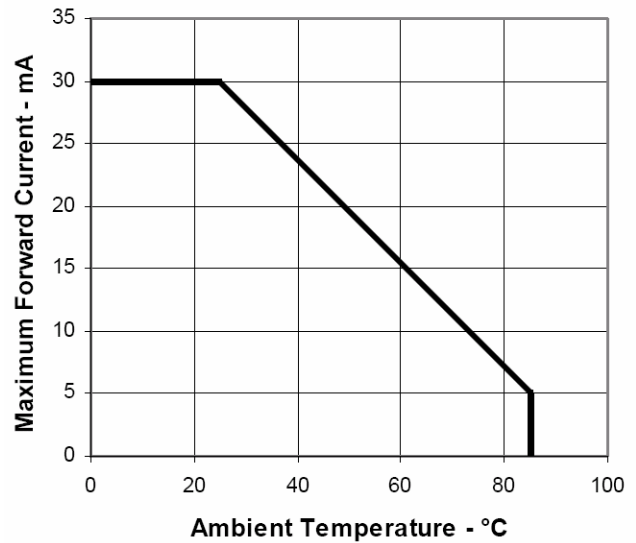

Figure 4. Maximum forward current vs. ambient temperature

Handling Caution

1. Bending radius of the lightpipe shall always be larger than 10 times of the lightpipe diameter to avoid impact to its appearance and performance.

For product information and a complete list of distributors, please go to our web site: www.avagotech.com

Avago, Avago Technologies, and the A logo are trademarks of Avago Technologies, Limited in the United States and other countries. Data subject to change. Copyright © 2006 Avago Technologies Limited. All rights reserved. Obsoletes AV01-0430EN AV01-0649EN - November 13, 2006

