

## 阅读申明

- 1.本站收集的数据手册和产品资料都来自互联网，版权归原作者所有。如读者和版权方有任何异议请及时告之，我们将妥善解决。
- 2.本站提供的中文数据手册是英文数据手册的中文翻译，其目的是协助用户阅读，该译文无法自动跟随原稿更新，同时也可能存在翻译上的不当。建议读者以英文原稿为参考以便获得更精准的信息。
- 3.本站提供的产品资料，来自厂商的技术支持或者使用者的心得体会等，其内容可能存在描述上的差异，建议读者做出适当判断。
- 4.如需与我们联系，请发邮件到marketing@iczoom.com，主题请标有“数据手册”字样。

## Read Statement

1. The datasheets and other product information on the site are all from network reference or other public materials, and the copyright belongs to the original author and original published source. If readers and copyright owners have any objections, please contact us and we will deal with it in a timely manner.
2. The Chinese datasheets provided on the website is a Chinese translation of the English datasheets. Its purpose is for reader's learning exchange only and do not involve commercial purposes. The translation cannot be automatically updated with the original manuscript, and there may also be improper translations. Readers are advised to use the English manuscript as a reference for more accurate information.
3. All product information provided on the website refer to solutions from manufacturers' technical support or users the contents may have differences in description, and readers are advised to take the original article as the standard.
4. If you have any questions, please contact us at marketing@iczoom.com and mark the subject with "Datasheets" .

# X42182

Z-Power series is designed for high current operation and high flux output applications.



Z-Power LED's thermal management perform exceeds other power LED solutions.

It incorporates state of the art SMD design and Thermal emission material.

Z Power LED is ideal light sources for general illumination applications, custom designed solutions, automotive large LCD backlights

# X42182

## Features

- Super high flux output and high luminance
- Designed for high current operation
- Low thermal resistance
- SMT solderability
- Lead free product
- RoHS compliant

## Applications

- Mobile phone flash
- Automotive interior / Exterior lighting
- Automotive signal lighting
- Automotive forward lighting
- Torch
- Architectural lighting
- LCD TV / Monitor backlight
- Projector light source
- Traffic signals
- Task lighting
- Decorative / Pathway lighting
- Remote / Solar powered lighting
- Household appliances

\*The appearance and specifications of the product may be changed for improvement without notice.

Rev. 04

November, 2009

[www.acriche.com](http://www.acriche.com)

## Full Code of Z-Power LED Series

Full code form :  $X_1 X_2 X_3 X_4 X_5 X_6 - X_7 X_8 - X_9 X_{10} X_{11} X_{12} X_{13}$

### 1. Part Number

- $X_1$  : Color
- $X_2$  : Z-Power LED series number
- $X_3$  : LENS type
- $X_4$  : Chip quantity (or Power Dissipation)
- $X_5$  : Package outline size
- $X_6$  : Type of PCB

### 2. Internal Number

- $X_7$  : Grade of characteristic code
- $X_8$

### 3. Code Labeling

- $X_9$  : Luminous flux (or Radiant flux for royal blue)
- $X_{10} X_{11} X_{12}$  : Dominant wavelength (or x,y coordinates rank code)
- $X_{13}$  : Forward voltage

### 4. Sticker Diagram on Reel & Aluminum Vinyl Bag

PART NO. :  $X_1 X_2 X_3 X_4 X_5 X_6 - X_7 X_8$





QUANTITY : ###



LOT NUMBER : #####



BIN CODE :  $X_{10} X_{11} X_{12} X_{13} X_{14}$

For more information about binning and labeling, refer to the Application Note -1

## Outline Dimension

### 1. Dome Type

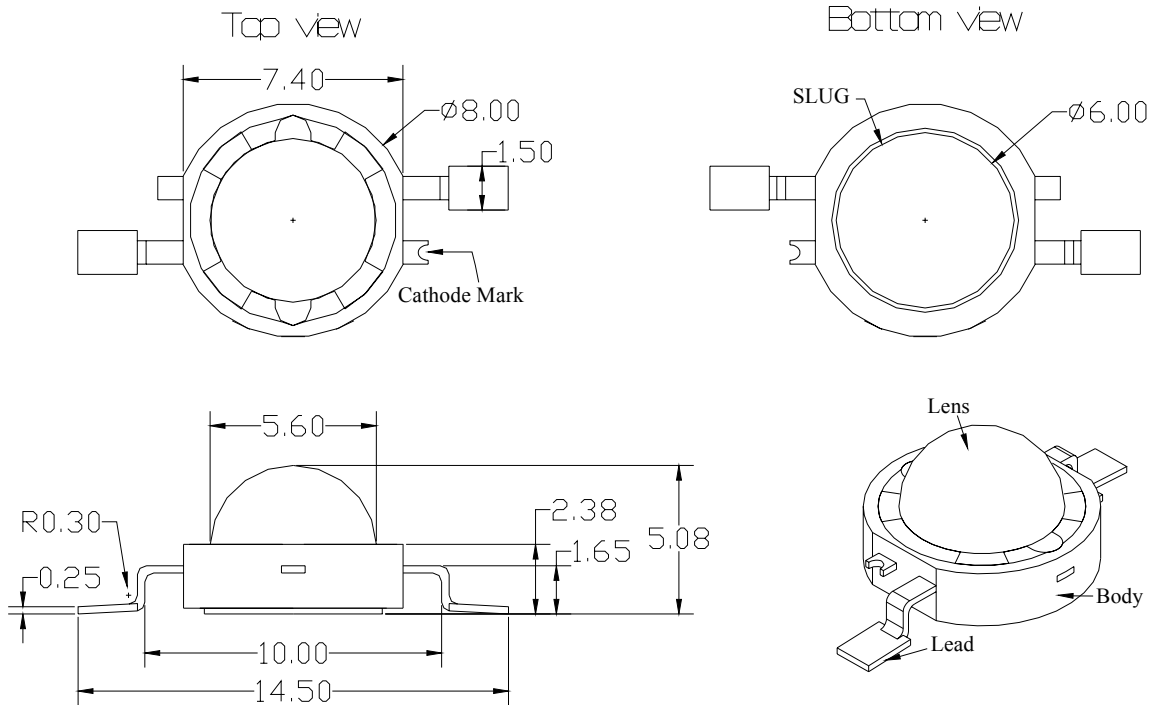

Notes :

1. All dimensions are in millimeters. (tolerance :  $\pm 0.2$  )
2. Scale : none
3. Slug of package is connected to anode.

\*The appearance and specifications of the product may be changed for improvement without notice.

## Outline Dimension

### 2. PCB Type

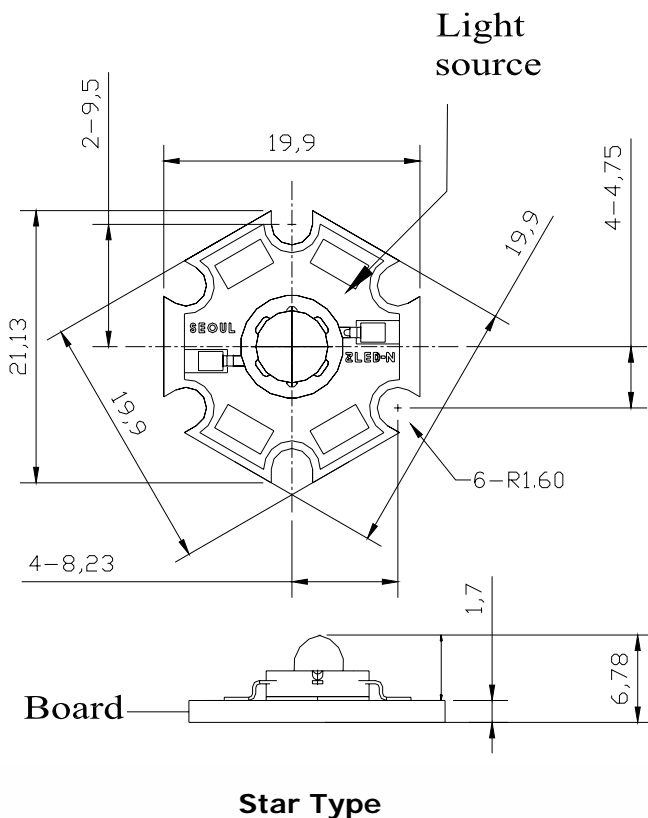

Notes :

1. All dimensions are in millimeters. (tolerance :  $\pm 0.2$  )
2. Scale : none

\*The appearance and specifications of the product may be changed for improvement without notice.

## Characteristics for Z-Power LED

### 1. Pure White (W42182)

1-1 Electro-Optical characteristics at  $I_F=350\text{mA}$ ,  $T_A=25^\circ\text{C}$

Parameter		Symbol	Value			Unit
			Min	Typ	Max	
Luminous Flux <sup>[1]</sup>	T rank	$\Phi_V$ <sup>[2]</sup>	70	80	91	lm
	U rank	$\Phi_V$ <sup>[2]</sup>	91	100	-	lm
Correlated Color Temperature <sup>[3]</sup>		CCT	-	6300	-	K
CRI		$R_a$	-	75	-	-
Forward Voltage <sup>[4]</sup>		$V_F$	3.0	3.25	4	V
View Angle		$2\theta_{1/2}$	127			deg.
Thermal resistance <sup>[5]</sup>		$R\theta_{J-B}$	8.8			$^\circ\text{C} / \text{W}$
Thermal resistance <sup>[6]</sup>		$R\theta_{J-C}$	7.2			$^\circ\text{C} / \text{W}$

### 1-2 Absolute Maximum Ratings

Parameter	Symbol	Value	Unit
Forward Current	$I_F$	1000 (@ $T_j = 90^\circ\text{C}$ ) <sup>[7]</sup>	mA
		1800 (@ 1KHz, 1/10 duty)	
Power Dissipation	$P_d$	4	W
Junction Temperature	$T_j$	145(@ $I_F \leq 700\text{mA}$ )	$^\circ\text{C}$
Operating Temperature	$T_{opr}$	-40 ~ +85	$^\circ\text{C}$
Storage Temperature	$T_{stg}$	-40 ~ +100	$^\circ\text{C}$
ESD Sensitivity <sup>[8]</sup>	-	$\pm 10,000\text{V HBM}$	-

\*Notes :

[1] SSC maintains a tolerance of  $\pm 10\%$  on flux and power measurements.

[2]  $\Phi_V$  is the total luminous flux output as measured with an integrated sphere.

[3] Correlated Color Temperature is derived from the CIE 1931 Chromaticity diagram. CCT  $\pm 5\%$  tester tolerance.

[4] A tolerance of  $\pm 0.06\text{V}$  on forward voltage measurements

[5], [6]  $R\theta_{J-B}$  is measured with a SSC metal core pcb. ( $25^\circ\text{C} \leq T_j \leq 110^\circ\text{C}$ )

$R\theta_{J-C}$  is measured with only emitter. ( $25^\circ\text{C} \leq T_j \leq 110^\circ\text{C}$ )

Break voltage of Metal PCB is 6.5kVAC.

[7]  $I_F$  Max is guaranteed under the  $T_j \leq 90^\circ\text{C}$ .

[8] It is included the zener chip to protect the product from ESD.

-----Caution-----

**1. Please do not drive at rated current more than 5 sec. without proper heat sink.**

## Characteristics for Z-Power LED

### 2. Warm White (N42182)

2-1 Electro-Optical characteristics at  $I_F=350\text{mA}$ ,  $T_A=25^\circ\text{C}$

Parameter	Symbol	Value			Unit
		Min	Typ	Max	
Luminous Flux <sup>[1]</sup>	$\Phi_V$ <sup>[2]</sup>	-	66	-	lm
Correlated Color Temperature <sup>[3]</sup>	CCT	-	3000	-	K
CRI	$R_a$	-	93	-	-
Forward Voltage <sup>[4]</sup>	$V_F$	3.0	3.25	4	V
View Angle	$2\theta$ 1/2	124			deg.
Thermal resistance <sup>[5]</sup>	$R\theta_{J-B}$	8.8			$^\circ\text{C} / \text{W}$
Thermal resistance <sup>[6]</sup>	$R\theta_{J-C}$	7.2			$^\circ\text{C} / \text{W}$

#### 2-2 Absolute Maximum Ratings

Parameter	Symbol	Value	Unit
Forward Current	$I_F$	800	mA
Power Dissipation	$P_d$	3.2	W
Junction Temperature	$T_j$	145	$^\circ\text{C}$
Operating Temperature	$T_{opr}$	-40 ~ +85	$^\circ\text{C}$
Storage Temperature	$T_{stg}$	-40 ~ +100	$^\circ\text{C}$
ESD Sensitivity <sup>[7]</sup>	-	$\pm 10,000\text{V}$ HBM	-

\*Notes :

- [1] SSC maintains a tolerance of  $\pm 10\%$  on flux and power measurements.
- [2]  $\Phi_V$  is the total luminous flux output as measured with an integrated sphere.
- [3] Correlated Color Temperature is derived from the CIE 1931 Chromaticity diagram.  
CCT  $\pm 5\%$  tester tolerance
- [4] A tolerance of  $\pm 0.06\text{V}$  on forward voltage measurements
- [5], [6]  $R\theta_{J-B}$  is measured with a SSC metal core pcb. ( $25^\circ\text{C} \leq T_j \leq 110^\circ\text{C}$ )  
 $R\theta_{J-C}$  is measured with only emitter. ( $25^\circ\text{C} \leq T_j \leq 110^\circ\text{C}$ )  
Break voltage of Metal PCB is 6.5kVAC
- [7] It is included the zener chip to protect the product from ESD.

-----Caution-----

1. Please do not drive at rated current more than 5 sec. without proper heat sink

## Characteristics for Z-Power LED

### 3. Warm White (N42182H)

3-1 Electro-Optical characteristics at  $I_F=350\text{mA}$ ,  $T_A=25^\circ\text{C}$

Parameter	Symbol	Value			Unit
		Min	Typ	Max	
Luminous Flux <sup>[1]</sup>	$\Phi_V$ <sup>[2]</sup>	-	77	-	lm
Correlated Color Temperature <sup>[3]</sup>	CCT	-	3000	-	K
CRI	$R_a$	-	80	-	-
Forward Voltage <sup>[4]</sup>	$V_F$	3.0	3.25	4	V
View Angle	$2\theta$ 1/2	124			deg.
Thermal resistance <sup>[5]</sup>	$R\theta_{J-B}$	8.8			$^\circ\text{C} / \text{W}$
Thermal resistance <sup>[6]</sup>	$R\theta_{J-C}$	7.2			$^\circ\text{C} / \text{W}$

### 3-2 Absolute Maximum Ratings

Parameter	Symbol	Value	Unit
Forward Current	$I_F$	800	mA
Power Dissipation	$P_d$	3.2	W
Junction Temperature	$T_j$	145	$^\circ\text{C}$
Operating Temperature	$T_{opr}$	-40 ~ +85	$^\circ\text{C}$
Storage Temperature	$T_{stg}$	-40 ~ +100	$^\circ\text{C}$
ESD Sensitivity <sup>[7]</sup>	-	$\pm 10,000\text{V}$ HBM	-

\*Notes :

- [1] SSC maintains a tolerance of  $\pm 10\%$  on flux and power measurements.
- [2]  $\Phi_V$  is the total luminous flux output as measured with an integrated sphere.
- [3] Correlated Color Temperature is derived from the CIE 1931 Chromaticity diagram.  
CCT  $\pm 5\%$  tester tolerance
- [4] A tolerance of  $\pm 0.06\text{V}$  on forward voltage measurements
- [5], [6]  $R\theta_{J-B}$  is measured with a SSC metal core pcb. ( $25^\circ\text{C} \leq T_j \leq 110^\circ\text{C}$ )  
 $R\theta_{J-C}$  is measured with only emitter. ( $25^\circ\text{C} \leq T_j \leq 110^\circ\text{C}$ )  
Break voltage of Metal PCB is 6.5kVAC
- [7] It is included the zener chip to protect the product from ESD.

-----Caution-----

1. Please do not drive at rated current more than 5 sec. without proper heat sink



## Characteristics for Z-Power LED

### 4. Natural White (S42182)

4-1 Electro-Optical characteristics at  $I_F=350\text{mA}$ ,  $T_A=25^\circ\text{C}$

Parameter	Symbol	Value			Unit
		Min	Typ	Max	
Luminous Flux <sup>[1]</sup>	$\Phi_V$ <sup>[2]</sup>	-	72	-	lm
Correlated Color Temperature <sup>[3]</sup>	CCT	-	4000	-	K
CRI	$R_a$	-	93	-	-
Forward Voltage <sup>[4]</sup>	$V_F$	3.0	3.25	4	V
View Angle	$2\theta$ 1/2	124			deg.
Thermal resistance <sup>[5]</sup>	$R\theta_{J-B}$	8.8			$^\circ\text{C} / \text{W}$
Thermal resistance <sup>[6]</sup>	$R\theta_{J-C}$	7.2			$^\circ\text{C} / \text{W}$

### 4-2 Absolute Maximum Ratings

Parameter	Symbol	Value	Unit
Forward Current	$I_F$	800	mA
Power Dissipation	$P_d$	3.2	W
Junction Temperature	$T_j$	145	$^\circ\text{C}$
Operating Temperature	$T_{opr}$	-40 ~ +85	$^\circ\text{C}$
Storage Temperature	$T_{stg}$	-40 ~ +100	$^\circ\text{C}$
ESD Sensitivity <sup>[8]</sup>	-	$\pm 10,000\text{V HBM}$	-

\*Notes :

[1] SSC maintains a tolerance of  $\pm 10\%$  on flux and power measurements.

[2]  $\Phi_V$  is the total luminous flux output as measured with an integrated sphere.

[3] Correlated Color Temperature is derived from the CIE 1931 Chromaticity diagram. CCT  $\pm 5\%$  tester tolerance.

[4] A tolerance of  $\pm 0.06\text{V}$  on forward voltage measurements

[5], [6]  $R\theta_{J-B}$  is measured with a SSC metal core pcb. ( $25^\circ\text{C} \leq T_j \leq 110^\circ\text{C}$ )

$R\theta_{J-C}$  is measured with only emitter. ( $25^\circ\text{C} \leq T_j \leq 110^\circ\text{C}$ )

Break voltage of Metal PCB is 6.5kVAC.

[7] It is included the zener chip to protect the product from ESD.

-----Caution-----

1. Please do not drive at rated current more than 5 sec. without proper heat sink

## Characteristics for Z-Power LED

### 5. Natural White (S42182H)

5-1 Electro-Optical characteristics at  $I_F=350\text{mA}$ ,  $T_A=25^\circ\text{C}$

Parameter	Symbol	Value			Unit
		Min	Typ	Max	
Luminous Flux <sup>[1]</sup>	$\Phi_V$ <sup>[2]</sup>	-	84	-	lm
Correlated Color Temperature <sup>[3]</sup>	CCT	-	4000	-	K
CRI	$R_a$	-	80	-	-
Forward Voltage <sup>[4]</sup>	$V_F$	3.0	3.25	4	V
View Angle	$2\theta$ 1/2	124			deg.
Thermal resistance <sup>[5]</sup>	$R\theta_{J-B}$	8.8			$^\circ\text{C} / \text{W}$
Thermal resistance <sup>[6]</sup>	$R\theta_{J-C}$	7.2			$^\circ\text{C} / \text{W}$

### 5-2 Absolute Maximum Ratings

Parameter	Symbol	Value	Unit
Forward Current	$I_F$	800	mA
Power Dissipation	$P_d$	3.2	W
Junction Temperature	$T_j$	145	$^\circ\text{C}$
Operating Temperature	$T_{opr}$	-40 ~ +85	$^\circ\text{C}$
Storage Temperature	$T_{stg}$	-40 ~ +100	$^\circ\text{C}$
ESD Sensitivity <sup>[8]</sup>	-	$\pm 10,000\text{V HBM}$	-

\*Notes :

- [1] SSC maintains a tolerance of  $\pm 10\%$  on flux and power measurements.
- [2]  $\Phi_V$  is the total luminous flux output as measured with an integrated sphere.
- [3] Correlated Color Temperature is derived from the CIE 1931 Chromaticity diagram. CCT  $\pm 5\%$  tester tolerance.
- [4] A tolerance of  $\pm 0.06\text{V}$  on forward voltage measurements
- [5], [6]  $R\theta_{J-B}$  is measured with a SSC metal core pcb. ( $25^\circ\text{C} \leq T_j \leq 110^\circ\text{C}$ )  
 $R\theta_{J-C}$  is measured with only emitter. ( $25^\circ\text{C} \leq T_j \leq 110^\circ\text{C}$ )  
 Break voltage of Metal PCB is 6.5kVAC.
- [7] It is included the zener chip to protect the product from ESD.

-----Caution-----

1. Please do not drive at rated current more than 5 sec. without proper heat sink

## Characteristics for Z-Power LED

### 6. Blue (B42182)

6-1 Electro-Optical characteristics at  $I_F=350\text{mA}$ ,  $T_A=25^\circ\text{C}$

Parameter	Symbol	Value			Unit
		Min	Typ	Max	
Luminous Flux <sup>[1]</sup>	$\Phi_V$ <sup>[2]</sup>	-	22	-	lm
Dominant Wavelength <sup>[3]</sup>	$\lambda_D$	455	465	475	nm
Forward Voltage <sup>[4]</sup>	$V_F$	3.0	3.25	4	V
View Angle	$2\theta$ 1/2	130			deg.
Thermal resistance <sup>[5]</sup>	$R\theta_{J-B}$	8.8			$^\circ\text{C} / \text{W}$
Thermal resistance <sup>[6]</sup>	$R\theta_{J-C}$	7.2			$^\circ\text{C} / \text{W}$

### 6-2 Absolute Maximum Ratings

Parameter	Symbol	Value	Unit
Forward Current	$I_F$	1000	mA
Power Dissipation	$P_d$	4	W
Junction Temperature	$T_j$	145	$^\circ\text{C}$
Operating Temperature	$T_{opr}$	-40 ~ +85	$^\circ\text{C}$
Storage Temperature	$T_{stg}$	-40 ~ +100	$^\circ\text{C}$
ESD Sensitivity <sup>[7]</sup>	-	$\pm 10,000\text{V HBM}$	-

\*Notes :

- [1] SSC maintains a tolerance of  $\pm 10\%$  on flux and power measurements.
- [2]  $\Phi_V$  is the total luminous flux output as measured with an integrated sphere.
- [3] Dominant wavelength is derived from the CIE 1931 Chromaticity diagram.  
A tolerance of  $\pm 0.5\text{nm}$  for dominant wavelength
- [4] A tolerance of  $\pm 0.06\text{V}$  on forward voltage measurements
- [5], [6]  $R\theta_{J-B}$  is measured with a SSC metal core pcb. ( $25^\circ\text{C} \leq T_j \leq 110^\circ\text{C}$ )  
 $R\theta_{J-C}$  is measured with only emitter. ( $25^\circ\text{C} \leq T_j \leq 110^\circ\text{C}$ )  
Break voltage of Metal PCB is 6.5kVAC
- [7] It is included the zener chip to protect the product from ESD.

-----Caution-----

1. Please do not drive at rated current more than 5 sec. without proper heat sink
2. Blue power light sources represented here are IEC825 Class 2 for eye safety

## Characteristics for Z-Power LED

### 7. Royal Blue (D42182)

7-1 Electro-Optical characteristics at  $I_F=350mA$ ,  $T_A=25^\circ C$

Parameter	Symbol	Value			Unit
		Min	Typ	Max	
Radiant Power <sup>[1]</sup>	$\Phi_V$ <sup>[2]</sup>	-	468	-	mW
Dominant Wavelength <sup>[3]</sup>	$\lambda_D$	455	457	460	nm
Forward Voltage <sup>[4]</sup>	$V_F$	3.0	3.25	3.8	V
View Angle	2 $\theta$ 1/2	130			deg.
Thermal resistance <sup>[5]</sup>	$R\theta_{J-B}$	8.8			$^\circ C /W$
Thermal resistance <sup>[6]</sup>	$R\theta_{J-C}$	7.2			$^\circ C /W$

7-2 Absolute Maximum Ratings

Parameter	Symbol	Value	Unit
Forward Current	$I_F$	1000	mA
Power Dissipation	$P_d$	4	W
Junction Temperature	$T_J$	145	$^\circ C$
Operating Temperature	$T_{opr}$	-40 ~ +85	$^\circ C$
Storage Temperature	$T_{stg}$	-40 ~ +100	$^\circ C$
ESD Sensitivity <sup>[7]</sup>	-	$\pm 10,000V$ HBM	-

\*Notes :

- [1] SSC maintains a tolerance of  $\pm 10\%$  on flux and power measurements.
- [2]  $\Phi_V$  is the total luminous flux output as measured with an integrated sphere.
- [3] Correlated Color Temperature is derived from the CIE 1931 Chromaticity diagram.  
CCT  $\pm 5\%$  tester tolerance
- [4] A tolerance of  $\pm 0.06V$  on forward voltage measurements
- [5], [6]  $R\theta_{J-B}$  is measured with a SSC metal core pcb. ( $25^\circ C \leq T_J \leq 110^\circ C$ )  
 $R\theta_{J-C}$  is measured with only emitter. ( $25^\circ C \leq T_J \leq 110^\circ C$ )  
Break voltage of Metal PCB is 6.5kVAC
- [7] It is included the zener chip to protect the product from ESD.

-----Caution-----

1. Please do not drive at rated current more than 5 sec. without proper heat sink
2. Blue power light sources represented here are IEC825 Class 2 for eye safety

## Characteristics for Z-Power LED

### 8. Green (G42182)

8-1 Electro-Optical characteristics at  $I_F=350\text{mA}$ ,  $T_A=25^\circ\text{C}$

Parameter	Symbol	Value			Unit
		Min	Typ	Max	
Luminous Flux <sup>[1]</sup>	$\Phi_V$ <sup>[2]</sup>	-	70	-	lm
Dominant Wavelength <sup>[3]</sup>	$\lambda_D$	520	525	535	nm
Forward Voltage <sup>[4]</sup>	$V_F$	3.0	3.25	4.1	V
View Angle	$2\theta$ 1/2	130			deg.
Thermal resistance <sup>[5]</sup>	$R\theta_{J-B}$	9.5			$^\circ\text{C} / \text{W}$
Thermal resistance <sup>[6]</sup>	$R\theta_{J-C}$	8.0			$^\circ\text{C} / \text{W}$

### 8-2 Absolute Maximum Ratings

Parameter	Symbol	Value	Unit
Forward Current	$I_F$	1000	mA
Power Dissipation	$P_d$	4	W
Junction Temperature	$T_J$	145	$^\circ\text{C}$
Operating Temperature	$T_{opr}$	-40 ~ +85	$^\circ\text{C}$
Storage Temperature	$T_{stg}$	-40 ~ +100	$^\circ\text{C}$
ESD Sensitivity <sup>[7]</sup>	-	$\pm 10,000\text{V HBM}$	-

\*Notes :

- [1] SSC maintains a tolerance of  $\pm 10\%$  on flux and power measurements.
- [2]  $\Phi_V$  is the total luminous flux output as measured with an integrated sphere.
- [3] Dominant wavelength is derived from the CIE 1931 Chromaticity diagram.  
A tolerance of  $\pm 0.5\text{nm}$  for dominant wavelength
- [4] A tolerance of  $\pm 0.06\text{V}$  on forward voltage measurements
- [5], [6]  $R\theta_{J-B}$  is measured with a SSC metal core pcb. ( $25^\circ\text{C} \leq T_J \leq 110^\circ\text{C}$ )  
 $R\theta_{J-C}$  is measured with only emitter. . ( $25^\circ\text{C} \leq T_J \leq 110^\circ\text{C}$ )  
Break voltage of Metal PCB is 6.5kVAC
- [7] It is included the zener chip to protect the product from ESD.

-----Caution-----

**1. Please do not drive at rated current more than 5 sec. without proper heat sin**

## Characteristics for Z-Power LED

### 9. Red (R42182)

9-1 Electro-Optical characteristics at  $I_F=350\text{mA}$ ,  $T_A=25^\circ\text{C}$

Parameter	Symbol	Value			Unit
		Min	Typ	Max	
Luminous Flux <sup>[1]</sup>	$\Phi_V$ <sup>[2]</sup>	-	48	-	lm
Dominant Wavelength <sup>[3]</sup>	$\lambda_D$	618	625	630	nm
Forward Voltage <sup>[4]</sup>	$V_F$	2.0	2.3	3.0	V
View Angle	$2\theta$ 1/2	130			deg.
Thermal resistance <sup>[5]</sup>	$R\theta_{J-B}$	9			$^\circ\text{C} / \text{W}$
Thermal resistance <sup>[6]</sup>	$R\theta_{J-C}$	7.8			$^\circ\text{C} / \text{W}$

### 9-2 Absolute Maximum Ratings

Parameter	Symbol	Value	Unit
Forward Current	$I_F$	800	mA
Power Dissipation	$P_d$	2.4	W
Junction Temperature	$T_j$	145	$^\circ\text{C}$
Operating Temperature	$T_{opr}$	-40 ~ +85	$^\circ\text{C}$
Storage Temperature	$T_{stg}$	-40 ~ +100	$^\circ\text{C}$
ESD Sensitivity <sup>[7]</sup>	-	$\pm 10,000\text{V}$ HBM	-

\*Notes :

[1] SSC maintains a tolerance of  $\pm 10\%$  on flux and power measurements.

[2]  $\Phi_V$  is the total luminous flux output as measured with an integrated sphere.

[3] Dominant wavelength is derived from the CIE 1931 Chromaticity diagram.

A tolerance of  $\pm 0.5\text{nm}$  for dominant wavelength

[4] A tolerance of  $\pm 0.06\text{V}$  on forward voltage measurements

[5], [6]  $R\theta_{J-B}$  is measured with a SSC metal core pcb. ( $25^\circ\text{C} \leq T_j \leq 110^\circ\text{C}$ )

$R\theta_{J-C}$  is measured with only emitter. ( $25^\circ\text{C} \leq T_j \leq 110^\circ\text{C}$ )

Break voltage of Metal PCB is 6.5kVAC

[7] It is included the zener chip to protect the product from ESD.

-----Caution-----

1. Please do not drive at rated current more than 5 sec. without proper heat sink

## Characteristics for Z-Power LED

### 10. Amber (A42182)

10-1 Electro-Optical characteristics at  $I_F=350\text{mA}$ ,  $T_A=25^\circ\text{C}$

Parameter	Symbol	Value			Unit
		Min	Typ	Max	
Luminous Flux <sup>[1]</sup>	$\Phi_V$ <sup>[2]</sup>	-	48	-	lm
Dominant Wavelength <sup>[3]</sup>	$\lambda_D$	585	590	595	nm
Forward Voltage <sup>[4]</sup>	$V_F$	2.0	2.3	3.0	V
View Angle	$2\theta$ 1/2	130			deg.
Thermal resistance <sup>[5]</sup>	$R\theta_{J-B}$	9			$^\circ\text{C} / \text{W}$
Thermal resistance <sup>[6]</sup>	$R\theta_{J-C}$	7.8			$^\circ\text{C} / \text{W}$

### 10-2 Absolute Maximum Ratings

Parameter	Symbol	Value	Unit
Forward Current	$I_F$	800	mA
Power Dissipation	$P_d$	2.4	W
Junction Temperature	$T_j$	145	$^\circ\text{C}$
Operating Temperature	$T_{opr}$	-40 ~ +85	$^\circ\text{C}$
Storage Temperature	$T_{stg}$	-40 ~ +100	$^\circ\text{C}$
ESD Sensitivity <sup>[7]</sup>	-	$\pm 10,000\text{V HBM}$	-

\*Notes :

- [1] SSC maintains a tolerance of  $\pm 10\%$  on flux and power measurements.
- [2]  $\Phi_V$  is the total luminous flux output as measured with an integrated sphere.
- [3] Dominant wavelength is derived from the CIE 1931 Chromaticity diagram.  
A tolerance of  $\pm 0.5\text{nm}$  for dominant wavelength
- [4] A tolerance of  $\pm 0.06\text{V}$  on forward voltage measurements
- [5], [6]  $R\theta_{J-B}$  is measured with a SSC metal core pcb. ( $25^\circ\text{C} \leq T_j \leq 110^\circ\text{C}$ )  
 $R\theta_{J-C}$  is measured with only emitter. ( $25^\circ\text{C} \leq T_j \leq 110^\circ\text{C}$ )  
Break voltage of Metal PCB is 6.5kVAC
- [7] It is included the zener chip to protect the product from ESD.

-----Caution-----

1. Please do not drive at rated current more than 5 sec. without proper heat sink

Color Spectrum,  $T_A=25^{\circ}\text{C}$

1. Pure White

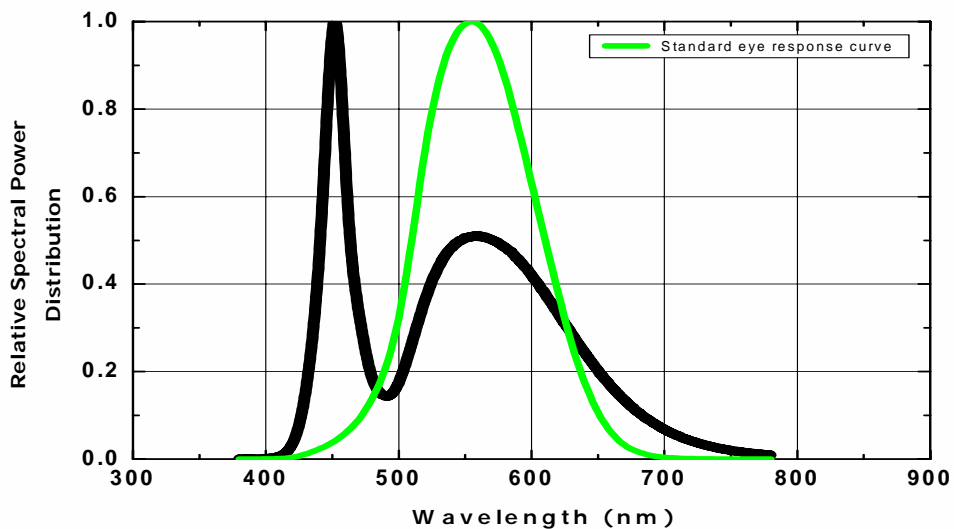

2. Warm White (N42182)

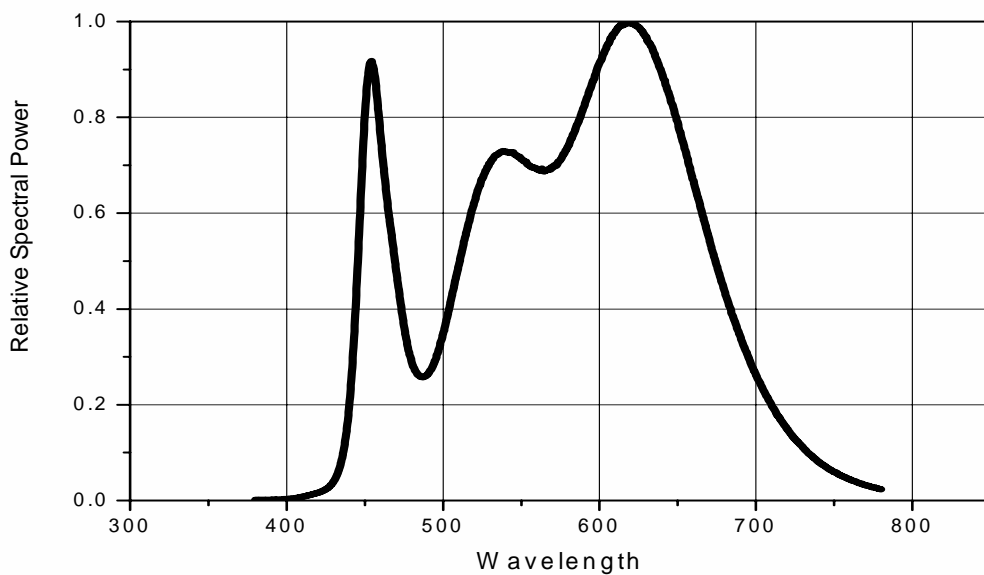



Color Spectrum,  $T_A=25^{\circ}\text{C}$

3. Warm White (N42182H)

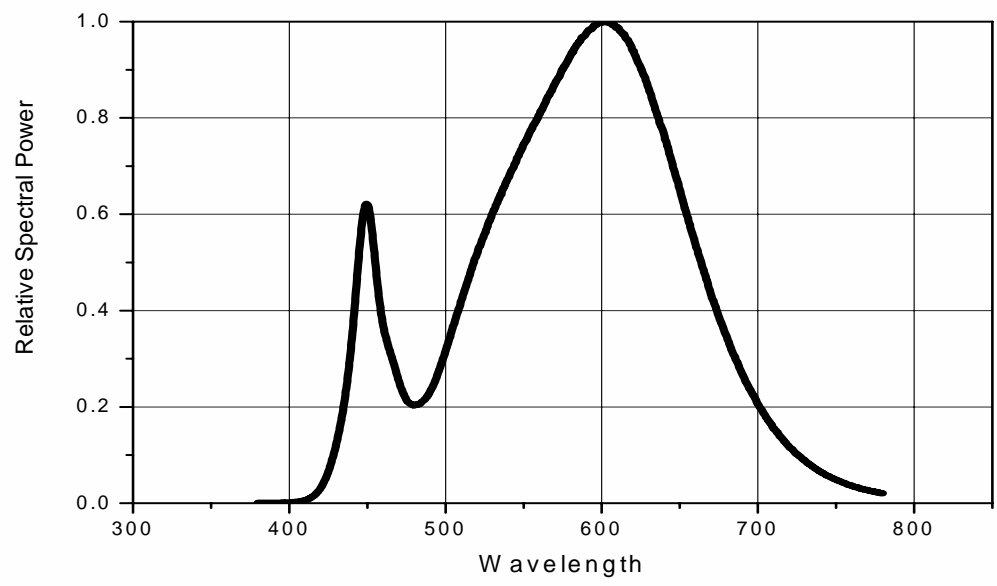

4. Natural White (S42182)

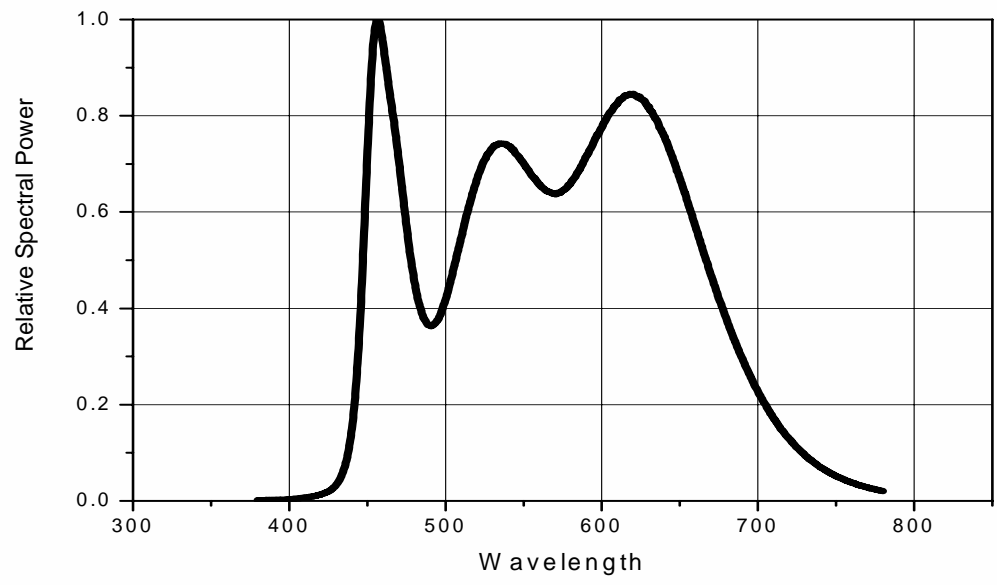

Color Spectrum,  $T_A=25^{\circ}\text{C}$

5. Natural White (S42182H)

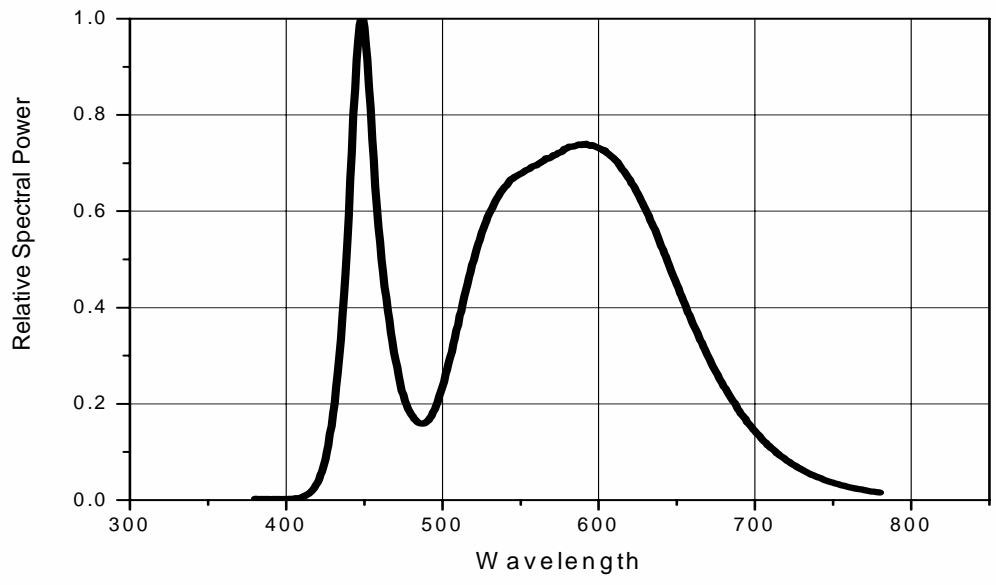

5. Red, Amber, Green, Blue(Royal Blue)

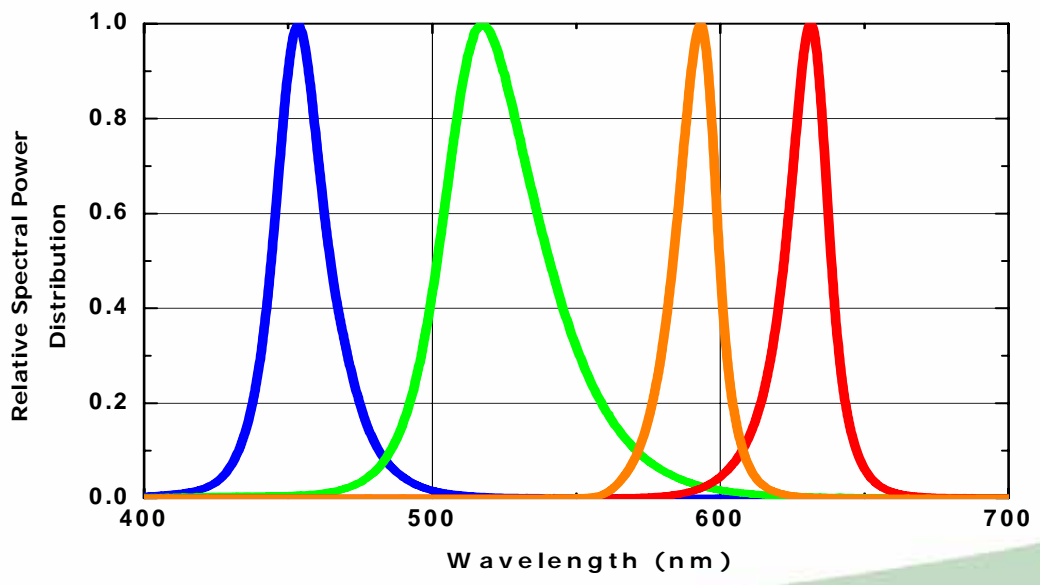

## Junction Temperature Characteristics

### 1. Relative Light Output vs. Junction Temperature at $I_F=350\text{mA}$

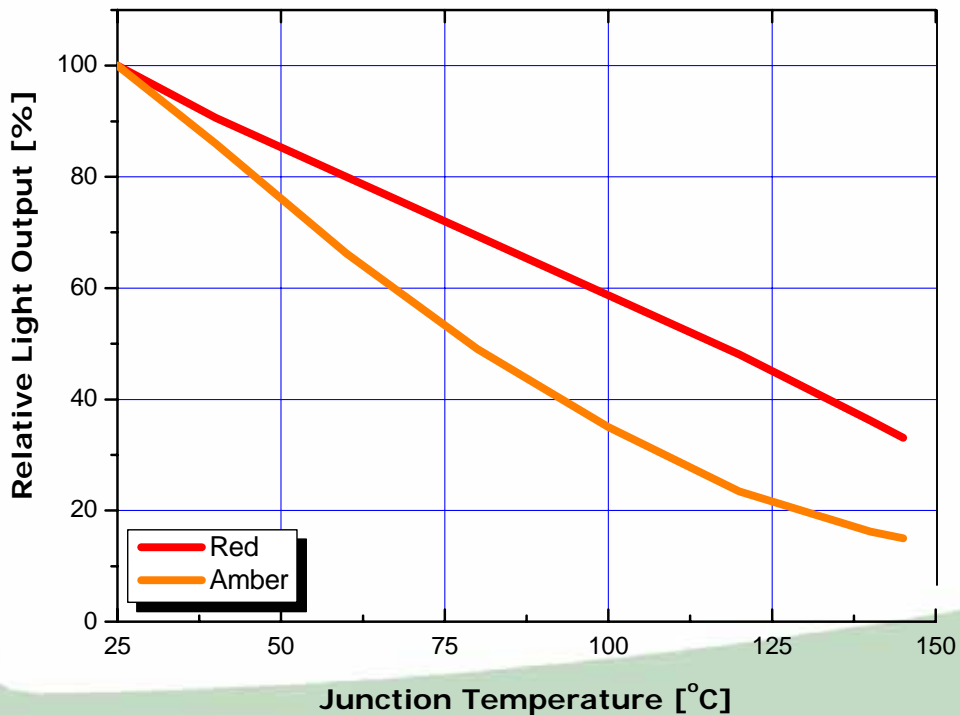
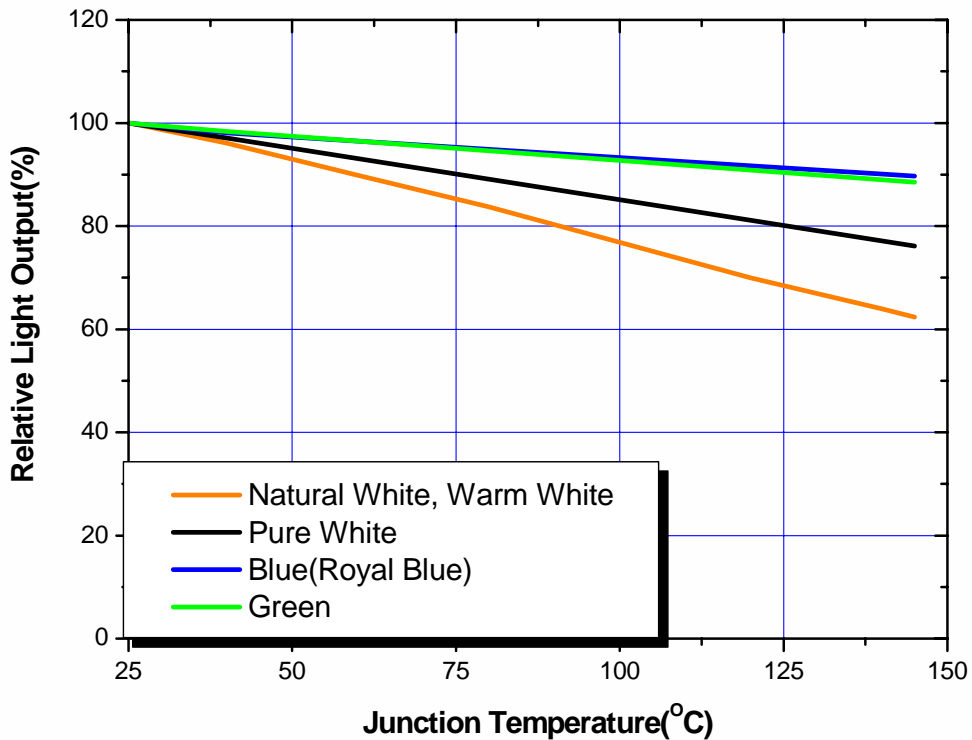

## Junction Temperature Characteristics

### 2. Forward Voltage Shift vs. Junction Temperature at $I_F=350\text{mA}$

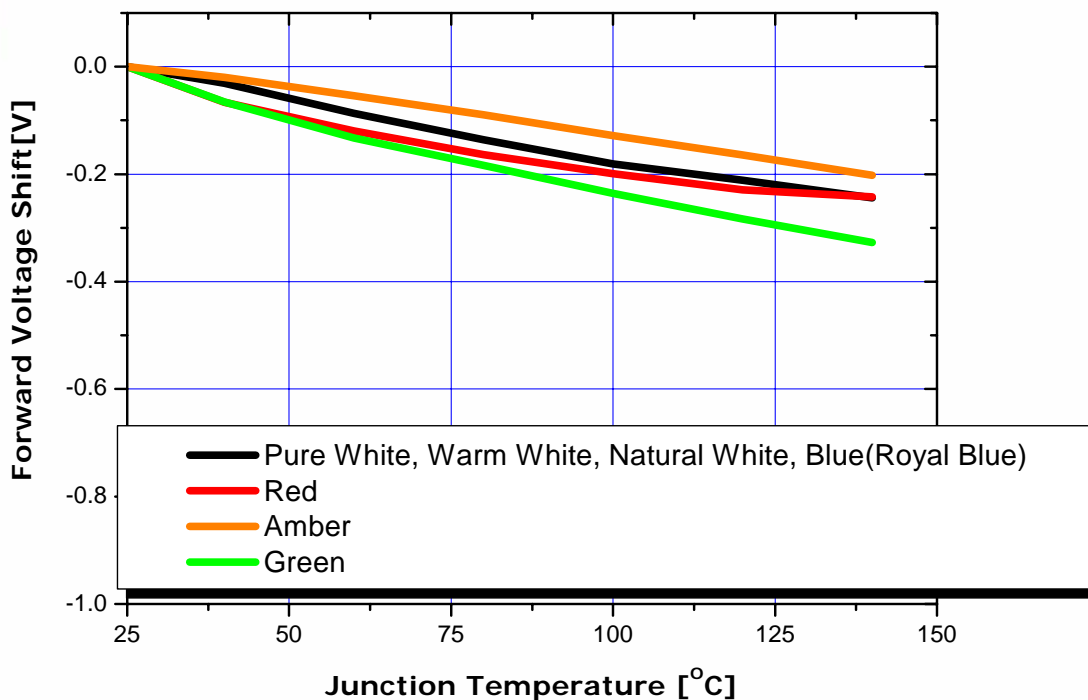

### 3. Wavelength Shift vs. Junction Temperature at $I_F=350\text{mA}$

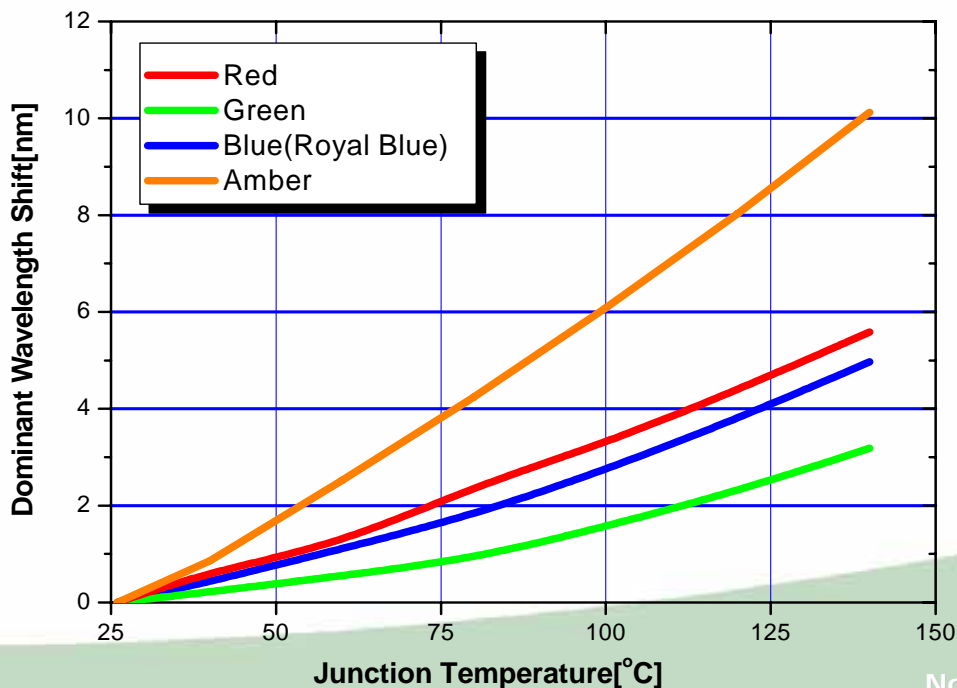

## Forward Current Characteristics

### 1. Forward Voltage vs. Forward Current , $T_A=25\text{ }^\circ\text{C}$

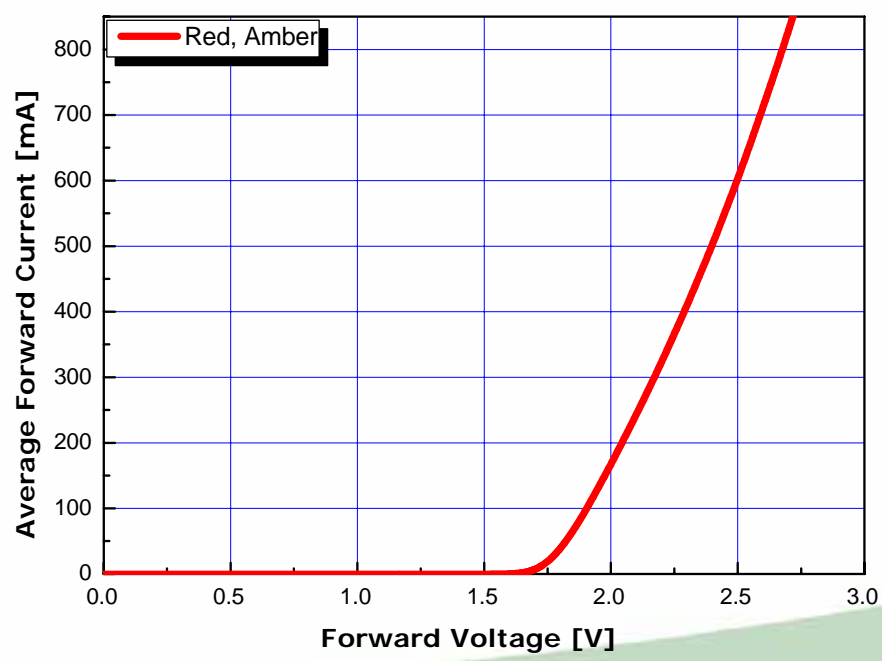
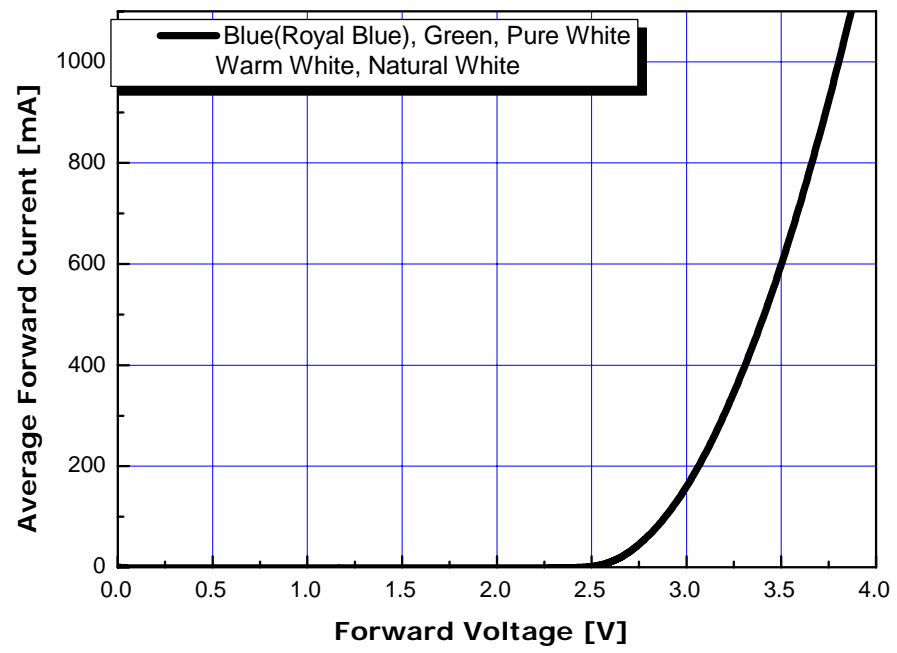

## Forward Current Characteristics

### 2. Forward Current vs. Normalized Relative Luminous Flux, $T_A=25\text{ }^\circ\text{C}$

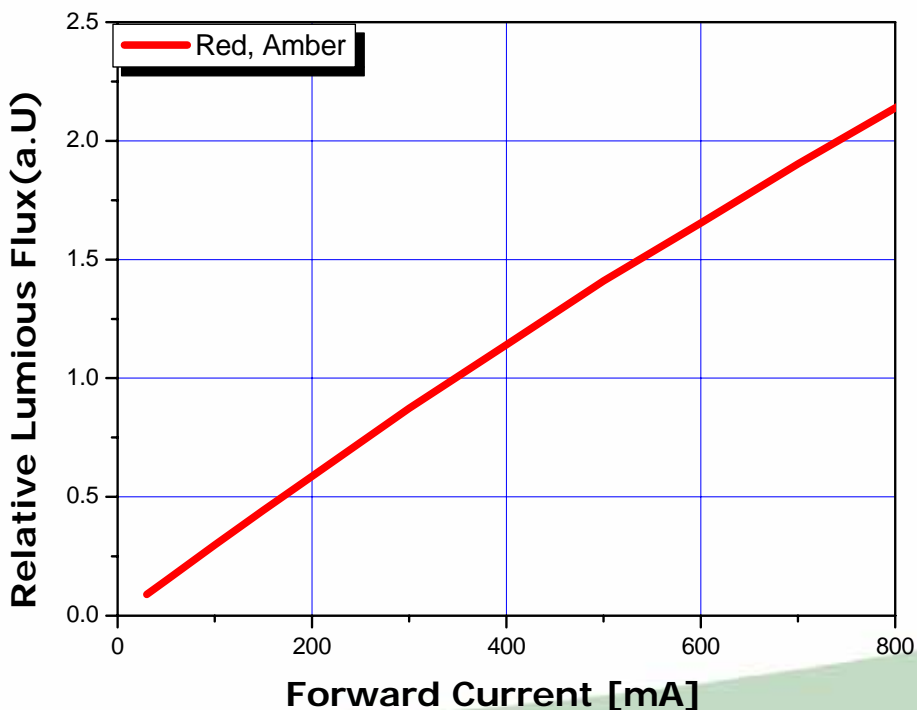
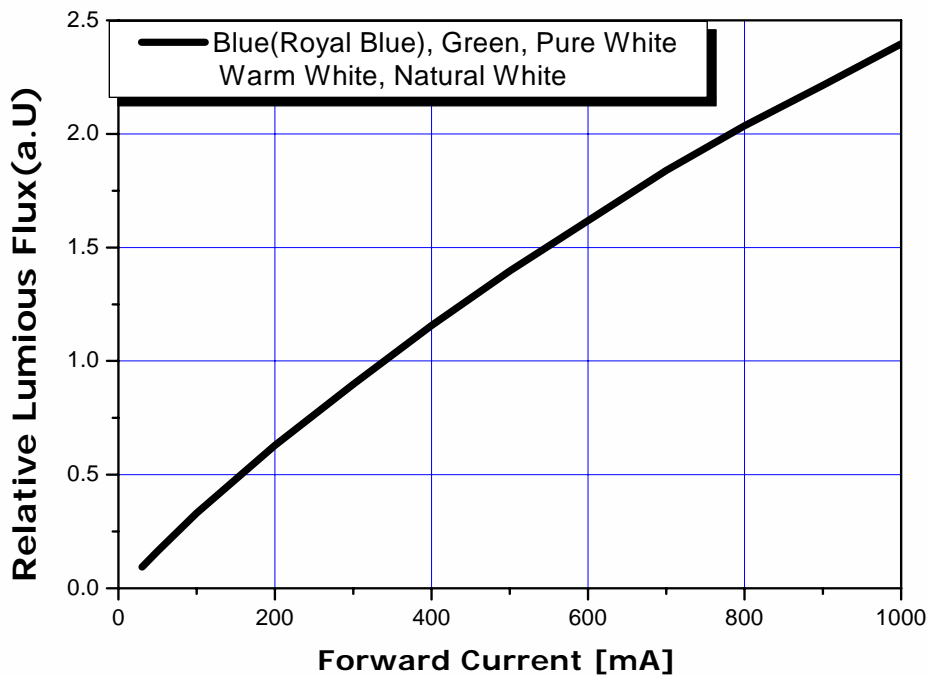

### Forward Current Characteristics

#### 3. Forward Current vs Wavelength Shift, $T_A=25\text{ }^\circ\text{C}$

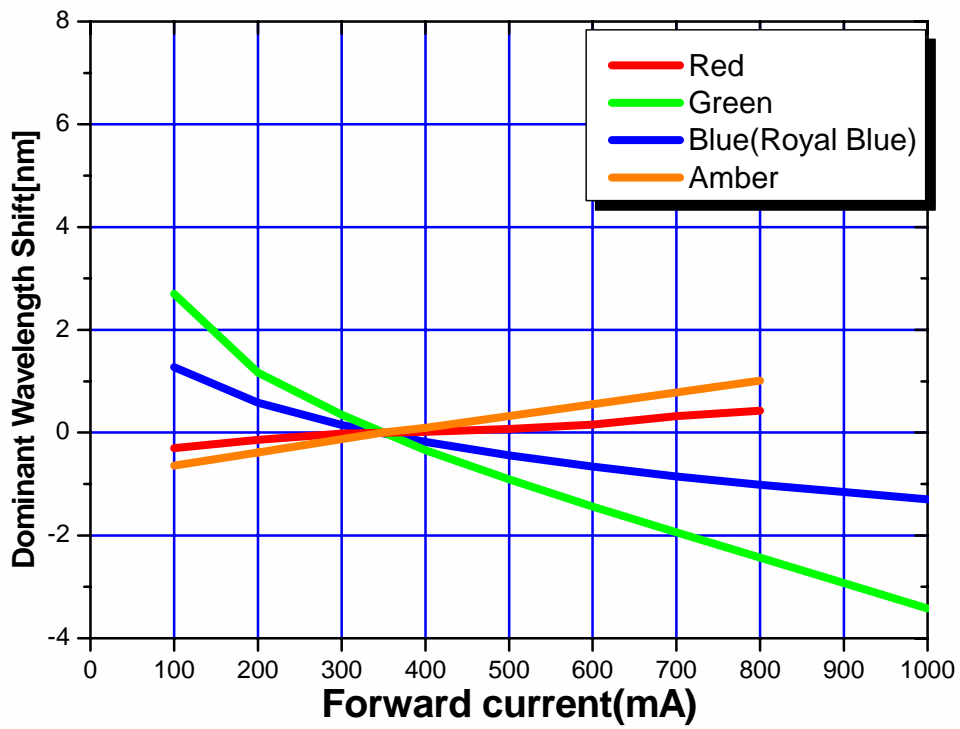

## Ambient Temperature vs Allowable Forward Current

### 1-1. Pure White, Warm White, Natural White, Green, Blue(Royal Blue) ( $T_{JMAX} = 145\text{ }^{\circ}\text{C}$ , @350mA)

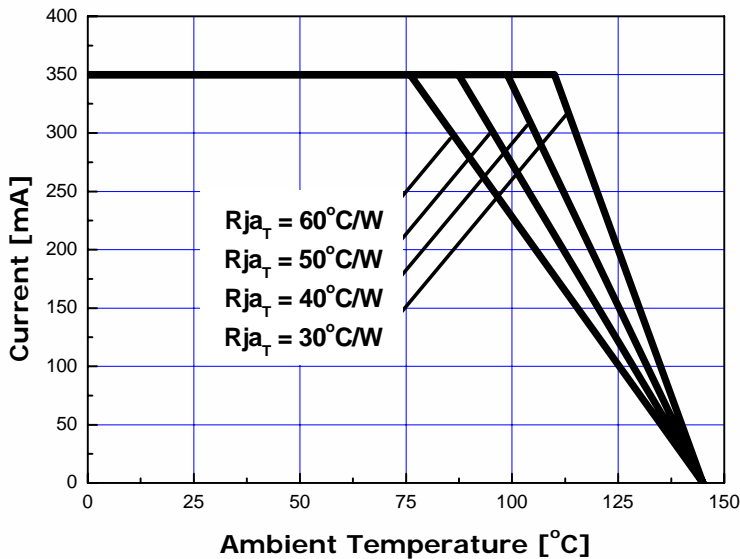

### 1-2. Pure White, Warm White, Natural White, Green, Blue(Royal Blue) ( $T_{JMAX} = 145\text{ }^{\circ}\text{C}$ , @700mA)

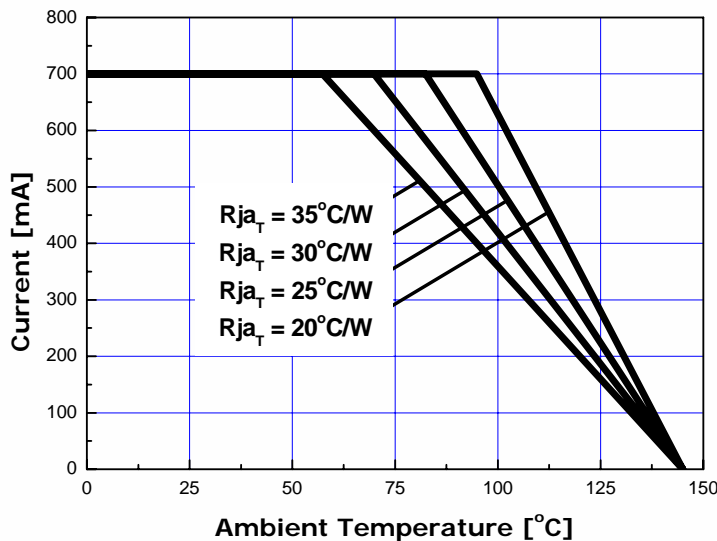



### Ambient Temperature vs Allowable Forward Current

1-3. Pure White, Green, Blue(Royal Blue)  
 ( $T_{JMAX} = 90\text{ }^{\circ}\text{C}$ , at 1000mA)

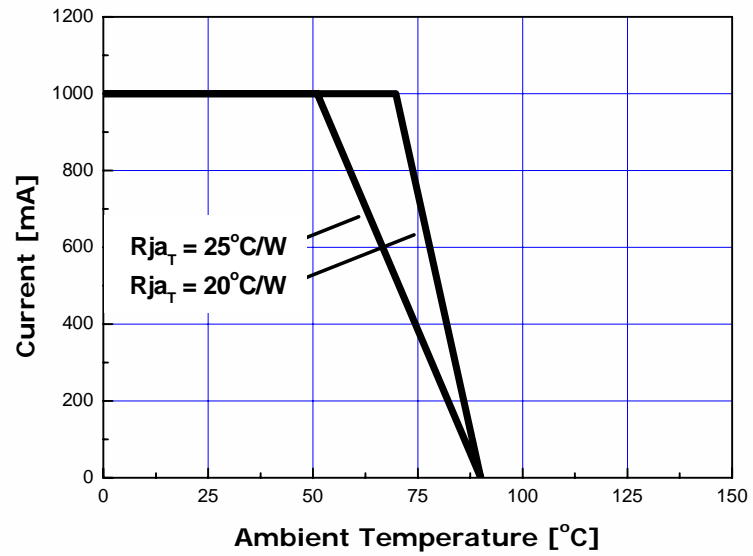

### Ambient Temperature vs Allowable Forward Current

#### 1-4. Red, Amber ( $T_{JMAX} = 145\text{ }^{\circ}\text{C}$ , at 350mA)

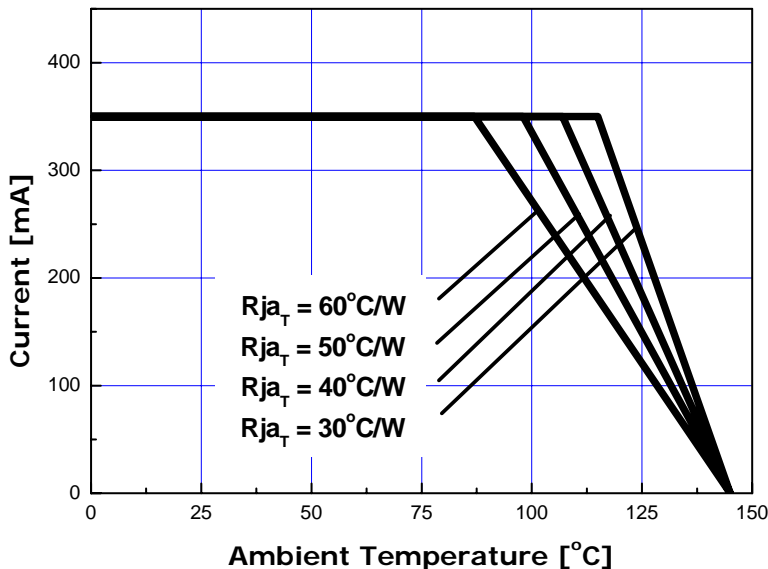

#### 1-5. Red, Amber ( $T_{JMAX} = 145\text{ }^{\circ}\text{C}$ , @700mA)

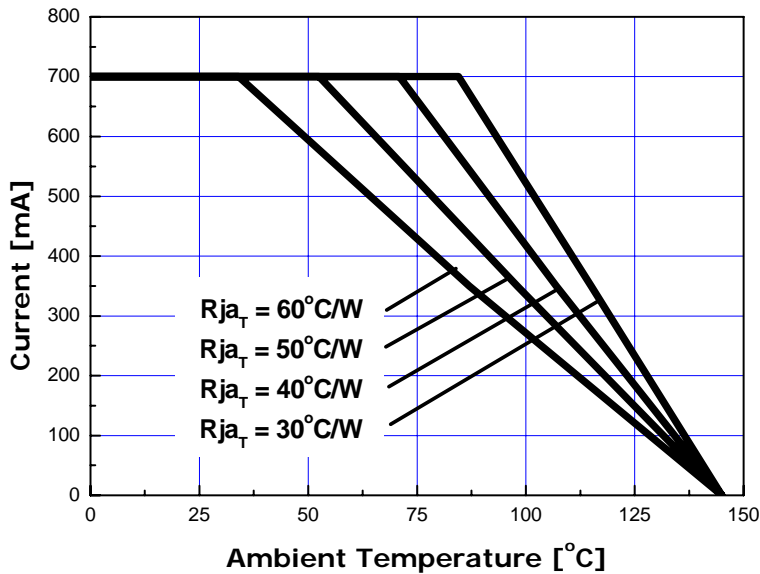

## Typical Dome Type Radiation pattern

### 1. Pure White

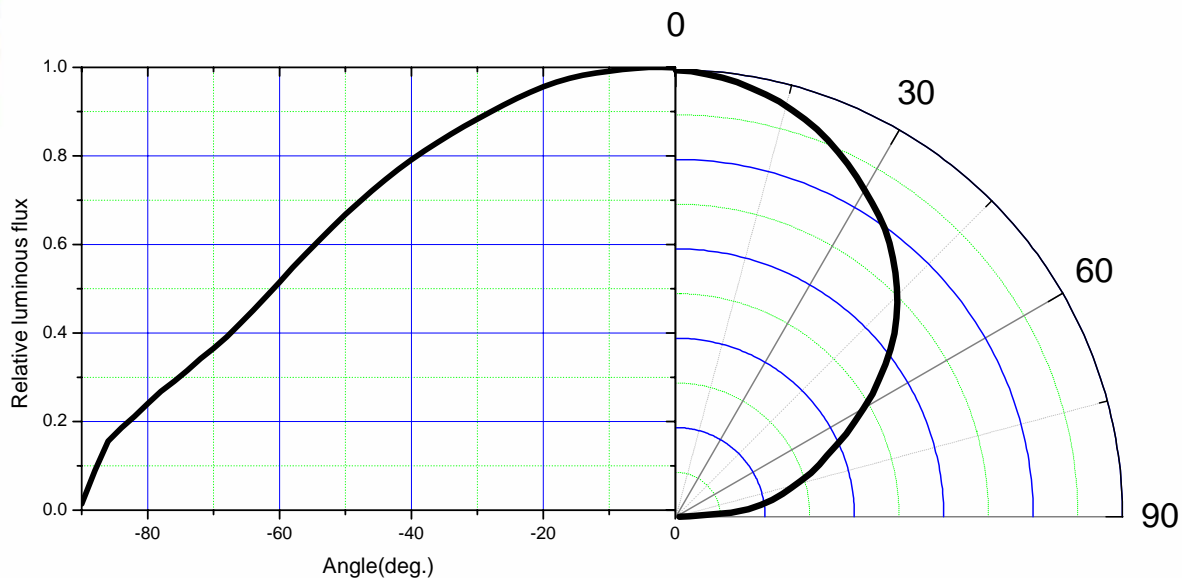

### 2. Warm White, Natural White

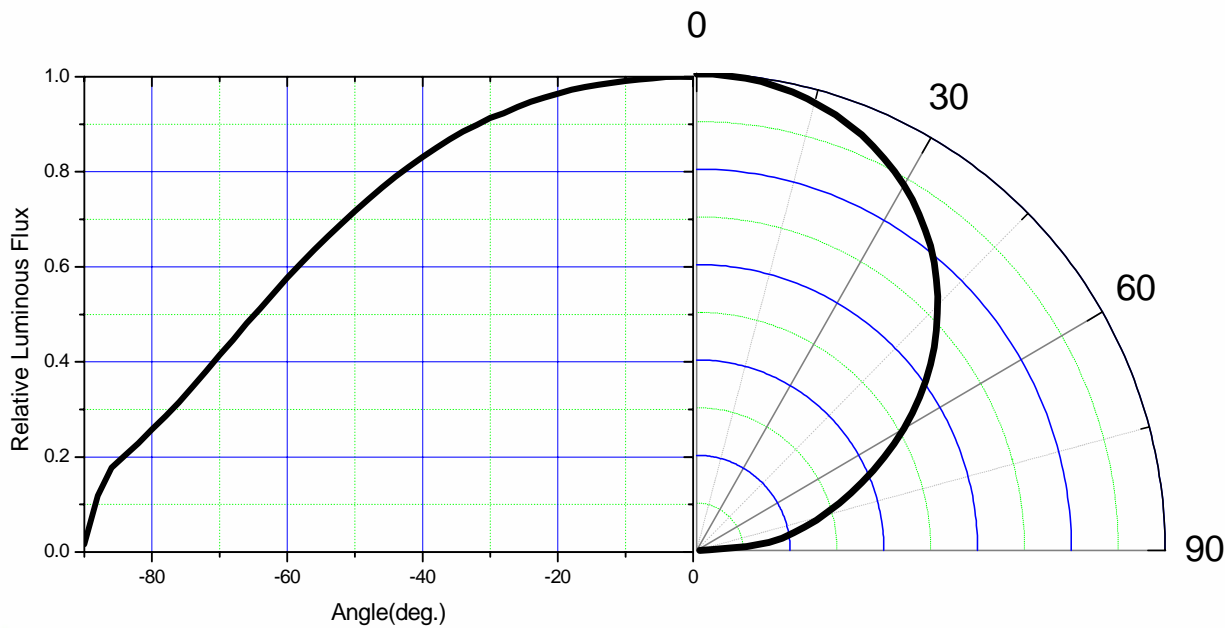

### Typical Dome Type Radiation pattern

#### 3. Blue(Royal Blue), Green

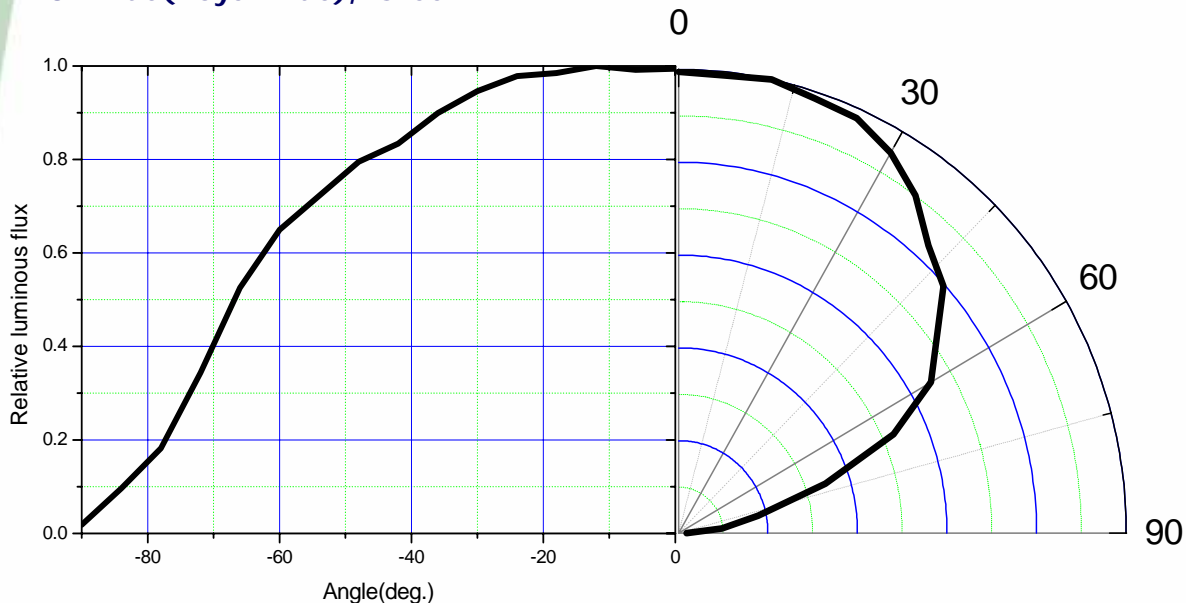

#### 4. Red, Amber

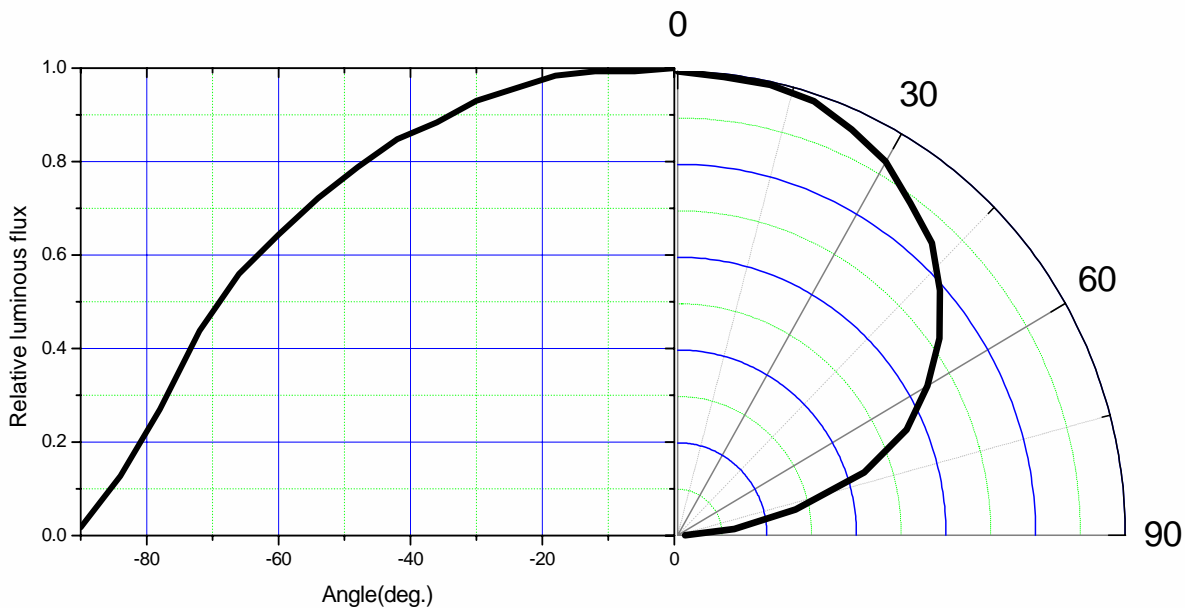

## Recommended Solder pad

### 1. Solder pad

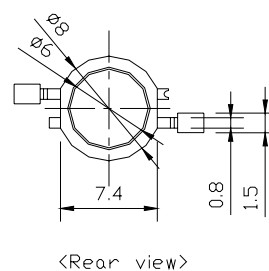
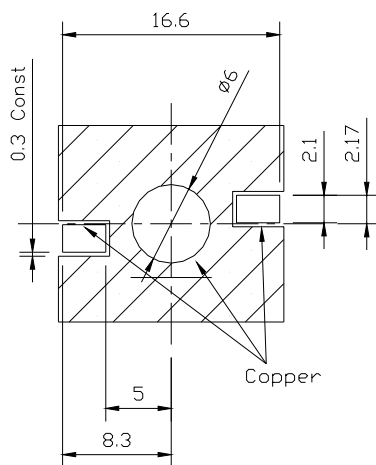
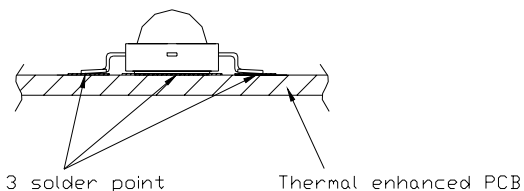

### 2. Solder paste pattern

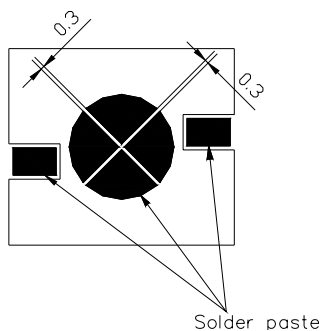

Note :

1. All dimensions are in millimeters (tolerance :  $\pm 0.2$  )
2. Scale none

\*The appearance and specifications of the product may be changed for improvement without notice.

### 3. Reflow Soldering Conditions / Profile

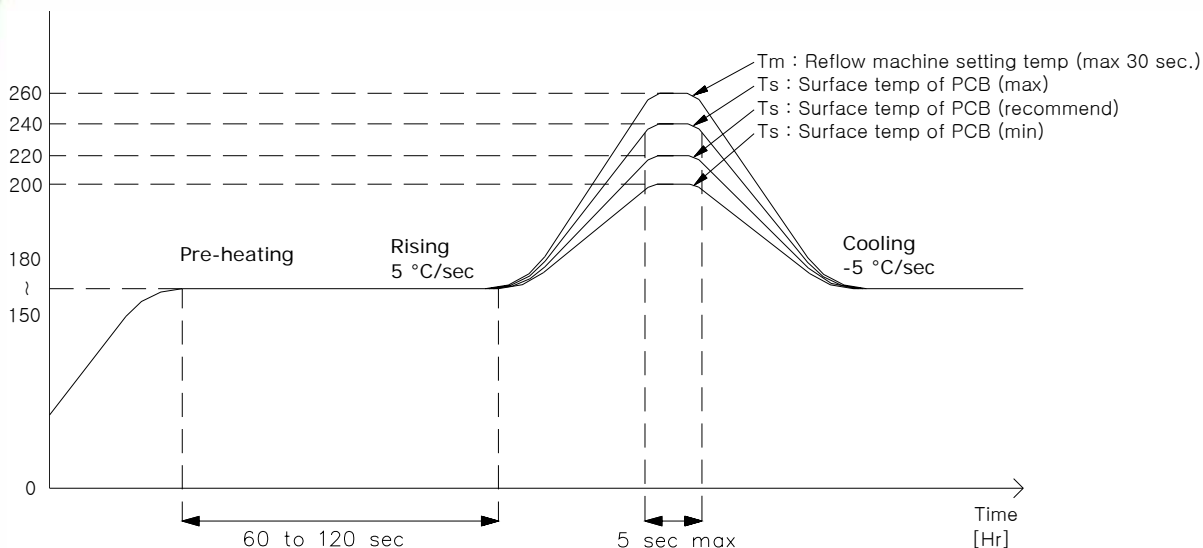

### 4. Hand Soldering conditions

**Lead : Not more than 3 seconds @MAX280°C**

**Slug : Use a thermal-adhesives**

#### \* Caution

1. Reflow soldering should not be done more than one time.
2. Repairing should not be done after the LEDs have been soldered.  
When repairing is unavoidable, suitable tools have to be used.
3. Die slug is to be soldered.
4. When soldering, do not put stress on the LEDs during heating.
5. After soldering, do not warp the circuit board.
6. Recommend to use a convection type reflow machine with 7 ~ 8 zones.

PCB Type Reel Packaging

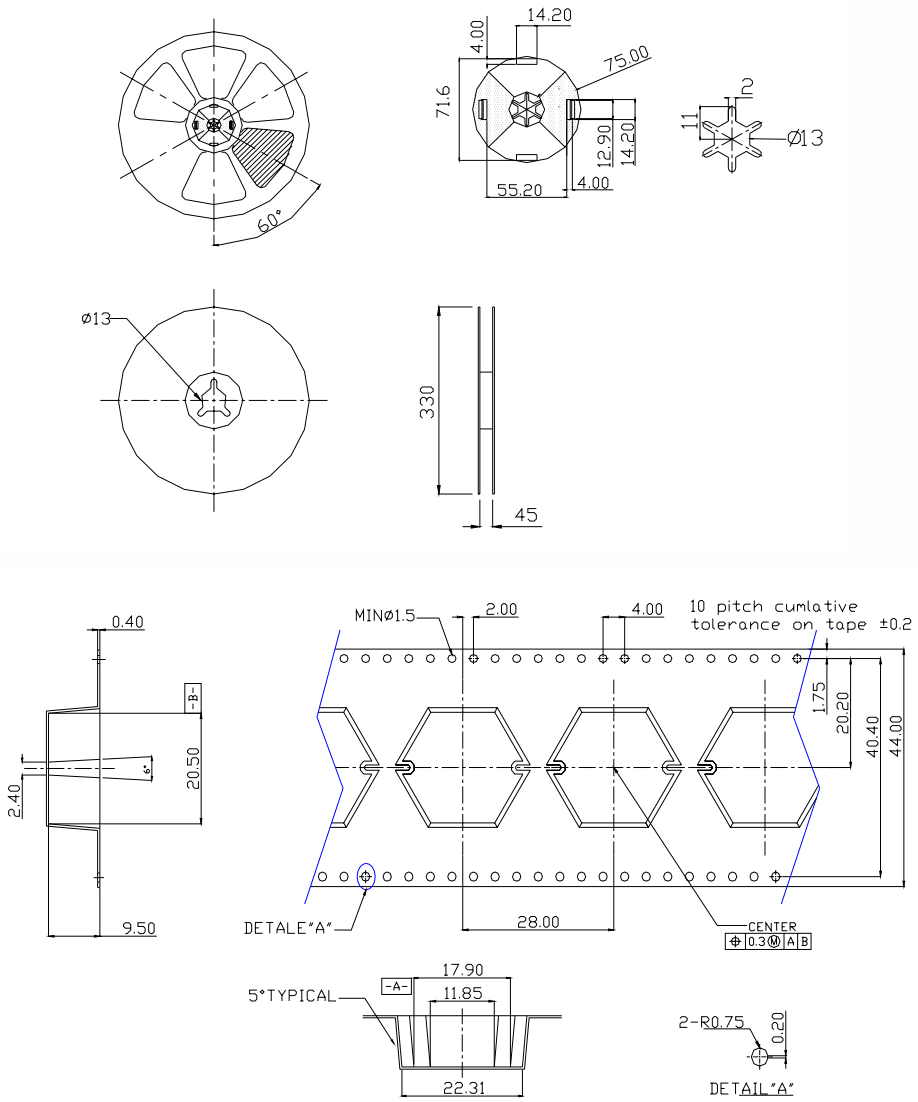

Note :

1. The number of loaded products in the reel is 200ea
2. All dimensions are in millimeters (tolerance : ±0.2 )
3. Scale none

\*The appearance and specifications of the product may be changed for improvement without notice.

## Packaging Structure

### Aluminum Vinyl Bag

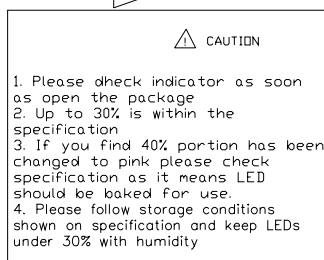
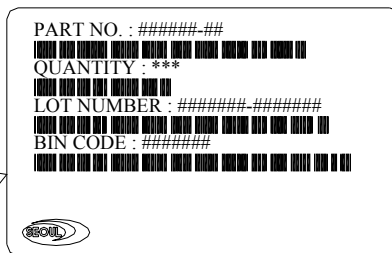
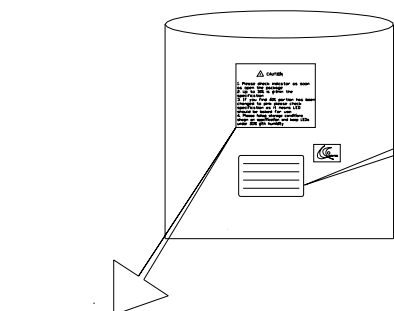

### Outer Box

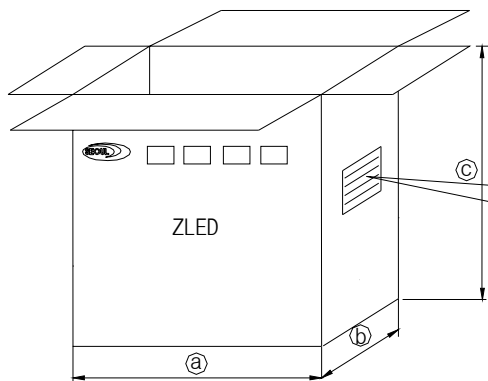

TYPE	SIZE (mm)		
	(a)	(b)	(c)
	350	350	370

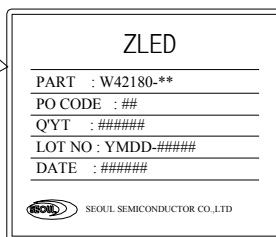

Note :

1. 6~10 reels are loaded in box
2. Scale none
3. For more information about binning and labeling, refer to the Application Note - 1



## precaution for use

- Storage

To avoid the moisture penetration, we recommend storing Z Power LEDs in a dry box (or desiccator) with a desiccant . The recommended storage conditions are Temperature 5 to 30 degrees Centigrade. Humidity 50% maximum.

- Precaution after opening packaging

However LED is correspond SMD, when LED be soldered dip, interfacial separation may affect the light transmission efficiency, causing the light intensity to drop.

Attention in followed.

- a. Soldering should be done right after opening the package(within 24Hrs).

- b. Keeping of a fraction

- Sealing

- Temperature : 5 ~ 40℃ Humidity : less than 30%

- c. If the package has been opened more than 1week or the color of desiccant changes, components should be dried for 10-12hr at 60±5℃

- Any mechanical force or any excess vibration shall not be accepted to apply during cooling process to normal temp. after soldering.
- Please avoid rapid cooling after soldering.
- Components should not be mounted on warped direction of PCB.
- Anti radioactive ray design is not considered for the products listed here in.
- Gallium arsenide is used in some of the products listed in this publication. These products are dangerous if they are burned or shredded in the process of disposal. It is also dangerous to drink the liquid or inhale the gas generated by such products when chemically disposed.
- This device should not be used in any type of fluid such as water, oil, organic solvent and etc. When washing is required, IPA(Isopropyl Alcohol) should be used.
- When the LEDs are illuminating, operating current should be decided after considering the package maximum temperature.
- LEDs must be stored to maintain a clean atmosphere. If the LEDs are stored for 3 months or more after being shipped from SSC, a sealed container with a nitrogen atmosphere should be used for storage.
- The appearance and specifications of the product may be modified for improvement without notice.
- Long time exposure of sunlight or occasional UV exposure will cause lens discoloration.
- The slug is connected to the anode. Therefore, we recommend to isolate the heat sink.
- Attaching LEDs, don't use adhesives to generate organic vapor.

Rev. 04

November. 2009

www.acriche.com

## Handling of Silicone resin LEDs

Z-Power LED is encapsulated by silicone resin for the highest flux efficiency.

Notes for handling of Silicone resin Z-Power LEDs

- Avoid touching silicone resin parts especially by sharp tools such as Pincette(Tweezers)
- Avoid leaving fingerprints on silicone resin parts.
- Dust sensitivity silicone resin need containers having cover for storage.
- When populating boards in SMT production, there are basically no restrictions regarding the form of the pick and place nozzle, except that mechanical pressure on the surface of the resin must be prevent.
- Please do not force over 2000 gf impact or pressure diagonally on the silicon lens.  
It will cause fatal damage of this product
- Please do not recommend to cover the silicone resin of the LEDs with other resin (epoxy, urethane, etc)