

阅读申明

- 1.本站收集的数据手册和产品资料都来自互联网，版权归原作者所有。如读者和版权方有任何异议请及时告之，我们将妥善解决。
- 2.本站提供的中文数据手册是英文数据手册的中文翻译，其目的是协助用户阅读，该译文无法自动跟随原稿更新，同时也可能存在翻译上的不当。建议读者以英文原稿为参考以便获得更精准的信息。
- 3.本站提供的产品资料，来自厂商的技术支持或者使用者的心得体会等，其内容可能存在描述上的差异，建议读者做出适当判断。
- 4.如需与我们联系，请发邮件到marketing@iczoom.com，主题请标有“数据手册”字样。

Read Statement

1. The datasheets and other product information on the site are all from network reference or other public materials, and the copyright belongs to the original author and original published source. If readers and copyright owners have any objections, please contact us and we will deal with it in a timely manner.
2. The Chinese datasheets provided on the website is a Chinese translation of the English datasheets. Its purpose is for reader's learning exchange only and do not involve commercial purposes. The translation cannot be automatically updated with the original manuscript, and there may also be improper translations. Readers are advised to use the English manuscript as a reference for more accurate information.
3. All product information provided on the website refer to solutions from manufacturers' technical support or users the contents may have differences in description, and readers are advised to take the original article as the standard.
4. If you have any questions, please contact us at marketing@iczoom.com and mark the subject with "Datasheets" .

Bridgelux RS Array Series

Product Data Sheet DS25

BXRA-27x4000, BXRA-27x7000, BXRA-30x4000, BXRA-30x7000, BXRA-35x4000, BXRA-35x7000, BXRA-40E4500, BXRA-40E7500, BXRA-5xC5300, BXRA-5xC9000

Introduction

The Bridgelux family of LED Array products delivers high performance, compact and cost-effective solid-state lighting solutions to serve the general lighting market. These products combine the higher efficacy, lifetime, and reliability benefits of LEDs with the light output levels of many conventional lighting sources. The Bridgelux RS Array Series has been specified to enable lamp and luminaire designs with comparable performance to existing high wattage CFL and HID conventional light sources for retail, commercial, industrial and outdoor/street lighting applications. Bridgelux Arrays are extremely well equipped for all types of light-on-demand applications, where they can be instantaneously and smoothly dimmed up or down without any effect on lifetime, unlike traditional CFL and HID light sources.

The Bridgelux RS Array series provides a high performance alternative to conventional solid state solutions, delivering between 3400 and 9000 lumens under application conditions in warm, neutral and cool white color temperatures. These compact high flux density light sources deliver uniform high quality illumination without pixilation or the multiple shadow effect caused by LED component based solutions, enabling excellent beam control for precision lighting. To simplify system design for appropriate light output, Bridgelux LED Arrays are specified to deliver performance under typical use conditions.

These integrated plug and play solutions reduce system complexity and enable miniaturized cost-effective lamp and luminaire designs. Luminaire designs incorporating these LED Arrays deliver system level performance comparable to that of 42-55 Watt CFL, 35-90 Watt low pressure sodium, 70-150 Watt high pressure sodium or 70-200 Watt metal halide based luminaires and feature increased system level and service life. Typical applications include retail lighting, commercial down lights, high bay, outdoor and street lights, and entertainment lighting.

Features

- Compact high flux density light source
- Uniform high quality illumination
- Minimum 70, 80 and 90 CRI options
- Streamlined thermal path
- Energy Star / ANSI compliant color binning structure with 3SDCM options
- More energy efficient than incandescent, halogen and fluorescent lamps
- Low voltage DC operation
- Instant light with unlimited dimming
- 5-Year warranty
- RoHS compliant and Pb free

Benefits

- Enhanced optical control
- Clean white light without pixilation
- High quality true color reproduction
- Significantly reduced thermal resistance and increased operating temperatures
- Uniform consistent white light
- Lower operating costs
- Increased safety
- Easy to use with daylight and motion detectors to enable increased energy savings
- Reduced maintenance costs
- Environmentally friendly, no disposal issue



Table of Contents	Page
Product Nomenclature	3
Average Lumen Maintenance Characteristics	3
Environmental Compliance	3
UL Recognition	4
Minor Product Change Policy	4
Cautionary Statements	4
Case Temperature Measurement Point	5
Quick Selection Guide	6
Flux Characteristics	7
Optical Characteristics	8
Electrical Characteristics	9
Absolute Minimum and Maximum Ratings	10
Typical Performance at Alternative Drive Currents	11
Mechanical Dimensions	13
Typical Radiation Pattern	14
Wavelength Characteristics at Rated Test Current, $T_j=25^\circ\text{C}$	15
Typical Relative Luminous Flux vs. Current, $T_j=25^\circ\text{C}$	16
Typical Light Output Characteristics vs. Temperature	17
Typical Chromaticity Characteristics vs. Temperature	18
Forward Current Characteristics	19
Color Binning Information	20
Design Resources	23

Product Nomenclature

The part number designation for Bridgelux LED Arrays is explained as follows:

BXRA – AB C DEFG – H – IJ - KLM

Where:

BXRA – Designates product family

AB – Designates the nominal ANSI color temperature; 27 = 2700K; 30 = 3000K, etc.

C - Designates minimum CRI; C = 70, E = 80, G = 90

DEFG - Designates Nominal Flux; 4000 = 4000lm, 7000 = 7000lm, 9000 = 9000lm, etc.

H – Designates configuration

IJ – Designates CCT Bin options

3000K as an example:

00 = Full ANSI: Q3, Q4, R3, R4

03 = 3 SDCM

KLM – Designates wire option

Average Lumen Maintenance Characteristics

Bridgelux projects that its family of LED Array products will deliver, on average, greater than 70% lumen maintenance after 50,000 hours of operation at the rated forward test current. This performance assumes constant current operation with case temperature maintained at or below 85°C. For use beyond these typical operating conditions please consult your Bridgelux sales representative for further assistance.

These projections are based on a combination of package test data, semiconductor chip reliability data, a fundamental understanding of package related degradation mechanisms, and performance observed from products installed in the field using Bridgelux die technology. Bridgelux conducts lumen maintenance tests per LM80. Observation of design limits is required in order to achieve this projected lumen maintenance.

Environmental Compliance

Bridgelux is committed to providing environmentally friendly products to the solid-state lighting market. Bridgelux LED Arrays are compliant to the European Union directives on the restriction of hazardous substances in electronic equipment, namely the RoHS directive. Bridgelux does not intentionally add the following restricted materials to LED Array products: lead, mercury, cadmium, hexavalent chromium, polybrominated biphenyls (PBB) or polybrominated diphenyl ethers (PBDE).

UL Recognition

Bridgelux secures UL Recognition for all the LED Array products. We continue to add arrays as they are recognized by UL. Please refer to the UL file E333389 for the latest list of UL Recognized Arrays. Bridgelux uses UL Recognized materials with suitable flammability ratings in the LED Array to streamline the process for customers to secure UL listing of the final luminaire product. Bridgelux recommends that luminaires are designed with a Class 2 Driver to facilitate the UL listing process.

Minor Product Change Policy

The rigorous qualification testing on products offered by Bridgelux provides performance assurance. Slight cosmetic changes that do not affect form, fit, or function may occur as Bridgelux continues product optimization.

Cautionary Statements

CAUTION: CONTACT WITH OPTICAL AREA

Do not touch the optical area of the LED Array. Avoid any contact with the optical area. Applying stress to the yellow phosphor resin area can result in damage to the LED Array.

Optics and reflectors must not be mounted in contact with the white phosphor resin area or the white ring that surrounds the yellow phosphor area. Using the white ring to secure optics can result in damage to the LED Array as the ring is not designed to act as a mechanical locating feature. Optical devices may be mounted on the top surface of the LED Array substrate outside of the white ring maximum OD as specified in the product data sheet. Use the mechanical features of the LED Array substrate edges and/or mounting holes to locate and secure the optical device as needed.

CAUTION: EYE SAFETY

Eye safety classification for the use of Bridgelux LED Arrays is in accordance with IEC specification EN62471; Photobiological Safety of Lamps and Lamp Systems. Bridgelux LED Arrays are classified as Risk Group 1 (Low Risk) when operated at or below their rated test current. Please use appropriate precautions. It is important that employees working with LEDs are trained to use them safely.

CAUTION: RISK OF BURN

Do not touch the LED Array or resin area during operation. Allow the LED Array to cool for a sufficient period of time before handling. The LED Array may reach elevated temperatures such that it can burn skin when touched.

CAUTION: CHEMICAL EXPOSURE HAZARD

Exposure to some chemicals commonly used in luminaire manufacturing and assembly can cause damage to the LED Array. Please consult Application Note AN11 for additional information.

Case Temperature Measurement Point

A case temperature measurement point location is included on the top surface of the Bridgelux LED Arrays. The location of this measurement point is indicated in the mechanical dimensions section of this data sheet.

The purpose of this measurement point is to allow the user access to a measurement point closely linked to the true case temperature on the back surface of the LED Array. Once the LED Array is installed, it is challenging to measure the back surface of the array, or true case temperature. Measuring the top surface of the product can lead to inaccurate results due to the poor thermal conductivity of the top layers of the array such as the solder mask and other materials.

Bridgelux has provided the case temperature measurement location in a manner which closely ties it to the true case temperature of the LED Array under steady state operation. Deviations between thermal measurements taken at the point indicated and the back of the LED Array differ by less than 1 °C, providing a robust method to testing thermal operation once the product is installed.

Quick Selection Guide

The following configurations are available:

Table 1: Selection Guide for RS Arrays

Base Part Number	CCT (Nominal)	CRI (min)	Typical Pulsed Flux T_j 25°C (lm)	Typical DC Flux T_{case} 70°C (lm)	Test Current (mA)	Vf (Typ) (V)	Power (Typ) (W)	Efficacy (Typ at T_j 25°C) (lm/W)
BXRA-27E4000-H-00	2700	80	4450	3980	2100	24.4	51	87
BXRA-27G4000-H-00	2700	90	3800	3400	2100	24.4	51	74
BXRA-27E7000-J-00	2700	80	7050	6190	2800	30.4	85	83
BXRA-27G7000-J-00	2700	90	6000	5270	2800	30.4	85	71
BXRA-30E4000-H-00	3000	80	4725	4230	2100	24.4	51	92
BXRA-30G4000-H-00	3000	90	4150	3715	2100	24.4	51	81
BXRA-30E7000-J-00	3000	80	7500	6580	2800	30.4	85	88
BXRA-30G7000-J-00	3000	90	6600	5790	2800	30.4	85	78
BXRA-35E4000-H-00	3500	80	5100	4560	2100	24.4	51	100
BXRA-35E7000-J-00	3500	80	8100	7110	2800	30.4	85	95
BXRA-40E4500-H-00	4000	80	5400	4830	2100	24.4	51	106
BXRA-40E7500-J-00	4000	80	8550	7500	2800	30.4	85	100
BXRA-50C5300-H-00	5000	70	6000	5370	2100	24.4	51	117
BXRA-50C9000-J-00	5000	70	9750	8560	2800	30.4	85	115
BXRA-56C5300-H-00	5600	70	6000	5370	2100	24.4	51	117
BXRA-56C9000-J-00	5600	70	9750	8560	2800	30.4	85	115

Flux Characteristics

Table 2: Flux Characteristics

Color	ANSI CCT (K)	Base Part Number	CRI (min) ⁽⁴⁾	Typical DC Flux $T_{\text{case}} = 70^{\circ}\text{C}$ (lm) ⁽³⁾	Minimum Pulsed Flux $T_j = 25^{\circ}\text{C}$ (lm) ⁽¹⁾	Typical Pulsed Flux $T_j = 25^{\circ}\text{C}$ (lm)	Test Current (mA) ⁽²⁾
Warm White	2700	BXRA-27E4000-H-00	80	3980	4000	4450	2100
		BXRA-27G4000-H-00	90	3400	3400	3800	2100
		BXRA-27E7000-J-00	80	6190	6350	7050	2800
		BXRA-27G7000-J-00	90	5270	5400	6000	2800
	3000	BXRA-30E4000-H-00	80	4230	4250	4725	2100
		BXRA-30G4000-H-00	90	3715	3750	4150	2100
		BXRA-30E7000-J-00	80	6580	6750	7500	2800
		BXRA-30G7000-J-00	90	5790	5950	6600	2800
3500	BXRA-35E4000-H-00	80	4560	4600	5100	2100	
	BXRA-35E7000-J-00	80	7110	7300	8100	2800	
Neutral White	4000	BXRA-40E4500-H-00	80	4830	4850	5400	2100
		BXRA-40E7500-J-00	80	7500	7700	8550	2800
Cool White	5000	BXRA-50C5300-H-00	70	5370	5400	6000	2100
		BXRA-50C9000-J-00	70	8560	8800	9750	2800
	5600	BXRA-56C5300-H-00	70	5370	5400	6000	2100
		BXRA-56C9000-J-00	70	8560	8800	9750	2800

Notes for Table 2:

1. Bridgelux maintains a $\pm 7\%$ tolerance of flux measurements.
2. Parts are tested in pulsed conditions, $T_j = 25^{\circ}\text{C}$. Pulse width is 10 ms at rated test current.
3. Typical performance when driven at DC (direct current) test current with LED Array case temperature maintained at 70°C , mounted to heat sink with thermal interface material. Please contact a Bridgelux sales representative for additional details.
4. Typical R9 value for 90 CRI product options is 50.
5. Reference Table 7 and 8 for typical performance at other driver currents (including those commonly available in the market).

Optical Characteristics

Table 3: Optical Characteristics

Color	ANSI CCT (K)	Base Part Number	Color Temperature (CCT) ^{[1], [2], [3]}			CRI (min)	Typical Viewing Angle (Degrees) $2\theta^{1/2}$ ^[4]	Typical Center Beam Candle Power ^[5] (cd)
			Min	Typ	Max			
Warm White	2700	BXRA-27E4000-H-00	2580 K	2725 K	2870 K	80	120	1420
		BXRA-27G4000-H-00	2580 K	2725 K	2870 K	90	120	1210
		BXRA-27E7000-J-00	2580 K	2725 K	2870 K	80	120	2240
		BXRA-27G7000-J-00	2580 K	2725 K	2870 K	90	120	1910
	3000	BXRA-30E4000-H-00	2870 K	3045 K	3220 K	80	120	1500
		BXRA-30G4000-H-00	2870 K	3045 K	3220 K	90	120	1320
		BXRA-30E7000-J-00	2870 K	3045 K	3220 K	80	120	2380
		BXRA-30G7000-J-00	2870 K	3045 K	3220 K	90	120	2100
3500	BXRA-35E4000-H-00	3220 K	3465 K	3710 K	80	120	1620	
	BXRA-35E7000-J-00	3220 K	3465 K	3710 K	80	120	2575	
Neutral White	4000	BXRA-40E4500-H-00	3700 K	4000 K	4250 K	80	120	1710
		BXRA-40E7500-J-00	3700 K	4000 K	4250 K	80	120	1720
Cool White	5000	BXRA-50C5300-H-00	4745 K	5100 K	5310 K	70	120	1910
		BXRA-50C9000-J-00	4745 K	5100 K	5310 K	70	120	3100
	5600	BXRA-56C5300-H-00	5310 K	5665 K	6020 K	70	120	1910
		BXRA-56C9000-J-00	5310 K	5665 K	6020 K	70	120	3100

Notes for Table 3:

1. Parts are tested in pulsed conditions, $T_j = 25^\circ\text{C}$. Pulse width is 10 ms at rated test current.
2. Refer to Flux Characteristic Table for test current data.
3. Product is binned for color in x y coordinates.
4. Viewing angle is the off axis angle from the centerline where I_v is $1/2$ of the peak value.
5. Center beam candle power is a calculated value based on lambertian radiation pattern at nominal test current.

Electrical Characteristics

Table 4: Electrical Characteristics

Color	Base Part Number	Forward Voltage Vf (V) ^[2]			Test Current (mA) ^[1]	Typical Coefficient of Forward Voltage (mV/°C) $\Delta Vf/\Delta Tj$	Typical Thermal Resistance Junction to Case (°C/W) $R\theta_{j-c}$
		Min	Typ	Max			
Warm White	BXRA-27E4000-H-00	21.9	24.4	26.8	2100	-8 to -24	0.31
	BXRA-27G4000-H-00	21.9	24.4	26.8	2100	-8 to -24	0.31
	BXRA-27E7000-J-00	27.4	30.4	33.4	2800	-10 to -30	0.26
	BXRA-27G7000-J-00	27.4	30.4	33.4	2800	-10 to -30	0.26
	BXRA-30E4000-H-00	21.9	24.4	26.8	2100	-8 to -24	0.31
	BXRA-30G4000-H-00	21.9	24.4	26.8	2100	-8 to -24	0.31
	BXRA-30E7000-J-00	27.4	30.4	33.4	2800	-10 to -30	0.26
	BXRA-30G7000-J-00	27.4	30.4	33.4	2800	-10 to -30	0.26
	BXRA-35E4000-H-00	21.9	24.4	26.8	2100	-8 to -24	0.31
	BXRA-35E7000-J-00	27.4	30.4	33.4	2800	-10 to -30	0.26
Neutral White	BXRA-40E4500-H-00	21.9	24.4	26.8	2100	-8 to -24	0.31
	BXRA-40E7500-J-00	27.4	30.4	33.4	2800	-10 to -30	0.26
Cool White	BXRA-50C5300-H-00	21.9	24.4	26.8	2100	-8 to -24	0.31
	BXRA-50C9000-J-00	27.4	30.4	33.4	2800	-10 to -30	0.26
	BXRA-56C5300-H-00	21.9	24.4	26.8	2100	-8 to -24	0.31
	BXRA-56C9000-J-00	27.4	30.4	33.4	2800	-10 to -30	0.26

Notes for Table 4:

1. Parts are tested in pulsed conditions, $T_j = 25^\circ\text{C}$. Pulse width is 10 ms at rated test current.
2. Bridgelux maintains a tester tolerance of ± 0.10 V on forward voltage measurements.

Absolute Minimum and Maximum Ratings

Table 5: Maximum Current and Reverse Voltage Ratings

Color	Base Part Number	Maximum DC Forward Current (mA)	Maximum Peak Pulsed Current (mA) ^[1]	Maximum Reverse Voltage (Vr) ^[2]
Warm White	BXRA-27E4000-H-00	3000	4000	-40 V
	BXRA-27G4000-H-00	3000	4000	-40 V
	BXRA-27E7000-J-00	3750	5000	-50 V
	BXRA-27G7000-J-00	3750	5000	-50 V
	BXRA-30E4000-H-00	3000	4000	-40 V
	BXRA-30G4000-H-00	3000	4000	-40 V
	BXRA-30E7000-J-00	3750	5000	-50 V
	BXRA-30G7000-J-00	3750	5000	-50 V
	BXRA-35E4000-H-00	3000	4000	-40 V
BXRA-35E7000-J-00	3750	5000	-50 V	
Neutral White	BXRA-40E4500-H-00	3000	4000	-40 V
	BXRA-40E7500-J-00	3750	5000	-50 V
Cool White	BXRA-50C5300-H-00	3000	4000	-40 V
	BXRA-50C9000-J-00	3750	5000	-50 V
	BXRA-56C5300-H-00	3000	4000	-40 V
	BXRA-56C9000-J-00	3750	5000	-50 V

Notes for Table 5:

1. Bridgelux recommends a maximum duty cycle of 10% when operating LED Arrays at the maximum peak pulsed current specified.
2. Light emitting diodes are not designed to be driven in reverse voltage.

Table 6: Maximum Ratings

Parameter	Maximum Rating
LED Junction Temperature	150 °C
Storage Temperature	-40 °C to +105 °C
Operating Case Temperature	105 °C
Soldering Temperature	350 °C or lower for a maximum of 3.5 seconds

Typical Performance at Alternative Drive Currents

The Bridgelux LED Arrays are tested and binned against the specifications shown in Tables 2, 3 and 4. Customers also have options to drive the LED Arrays at alternative drive currents dependent on the specific application. The typical performance at any drive current can be derived from the flux vs. current characteristics shown in Figures 5 and 6 and from the current vs. voltage characteristics shown in Figures 10 and 11. The typical performance at common drive currents is also summarized in Tables 7 and 8.

Table 7: Typical Product Performance at Alternative Drive Currents

Color	ANSI CCT (K)	Part Number	CRI	Typical DC Luminous Flux ϕ_v (lm), $T_{case}=70\text{ }^{\circ}\text{C}$	Typical Pulsed Luminous Flux ϕ_v (lm), $T_j=25\text{ }^{\circ}\text{C}$	Typical Forward Voltage V_f (V)	Forward Current (mA) ^[2]
Warm White	2700	BXRA-27E4000-H-00	80	2660	2970	23.4	1400
				3270	3640	24.0	1750
				3980	4450	24.4	2100⁽¹⁾
		BXRA-27G4000-H-00	90	2270	2530	23.4	1400
				2790	3110	24.0	1750
				3400	3800	24.4	2100⁽¹⁾
		BXRA-27E7000-J-00	80	4910	5590	29.2	1750
				5820	6630	29.8	2100
				6190	7050	30.7	2800⁽¹⁾
		BXRA-27G7000-J-00	90	4180	4755	29.2	1750
				4960	5640	29.8	2100
				5270	6000	30.7	2800⁽¹⁾
	3000	BXRA-30E4000-H-00	80	2830	3150	23.4	1400
				3480	3870	24.0	1750
				4230	4725	24.4	2100⁽¹⁾
		BXRA-30G4000-H-00	90	2480	2770	23.4	1400
				3095	3400	24.0	1750
				3715	4150	24.4	2100⁽¹⁾
		BXRA-30E7000-J-00	80	5220	5960	29.2	1750
				6190	7060	29.8	2100
				6580	7500	30.7	2800⁽¹⁾
		BXRA-30G7000-J-00	90	4590	5240	29.2	1750
				5440	6210	29.8	2100
				5790	6600	30.7	2800⁽¹⁾

Typical Performance at Alternative Drive Currents (continued)

Table 8: Typical Product Performance at Alternative Drive Currents

Color	ANSI CCT (K)	Part Number	CRI	Typical DC Luminous Flux ϕ_v (lm), $T_{case}=70^\circ\text{C}$	Typical Pulsed Luminous Flux ϕ_v (lm), $T_j=25^\circ\text{C}$	Typical Forward Voltage V_f (V)	Forward Current (mA) ⁽²⁾
Warm White	3500	BXRA-35E4000-H-00	80	3130	3500	23.4	1400
				3840	4300	24.0	1750
				4560	5100	24.4	2100⁽¹⁾
		BXRA-35E7000-J-00	80	5640	6430	29.2	1750
				6680	7620	29.8	2100
				7110	8100	30.7	2800⁽¹⁾
Neutral White	4000	BXRA-40E4500-H-00	80	3210	3610	23.4	1400
				3940	4435	24.0	1750
				4830	5400	24.4	2100⁽¹⁾
		BXRA-40E7500-J-00	80	5955	6790	29.2	1750
				7060	8050	29.8	2100
				7500	8550	30.7	2800⁽¹⁾
Cool White	5000	BXRA-50C5300-H-00	70	3590	4000	23.4	1400
				4400	4925	24.0	1750
				5370	6000	24.4	2100⁽¹⁾
		BXRA-50C9000-J-00	70	6795	7740	29.2	1750
				8050	9170	29.8	2100
				8560	9750	30.7	2800⁽¹⁾
	5600	BXRA-56C5300-H-00	70	3590	4000	23.4	1400
				4400	4920	24.0	1750
				5370	6000	24.4	2100⁽¹⁾
BXRA-56C9000-J-00	70	6795	7740	29.2	1750		
		8050	9170	29.8	2100		
		8560	9750	30.7	2800⁽¹⁾		

Notes for Table 7 and 8:

1. Product is tested and binned at the specified drive current.
2. Operating these LED Arrays at or below the drive currents listed in Tables 7 and 8, with a case temperature maintained at or below 85°C, will enable the average lumen maintenance projection outlined earlier in this Product Data Sheet.

Mechanical Dimensions

Figure 1: Drawing for RS Arrays

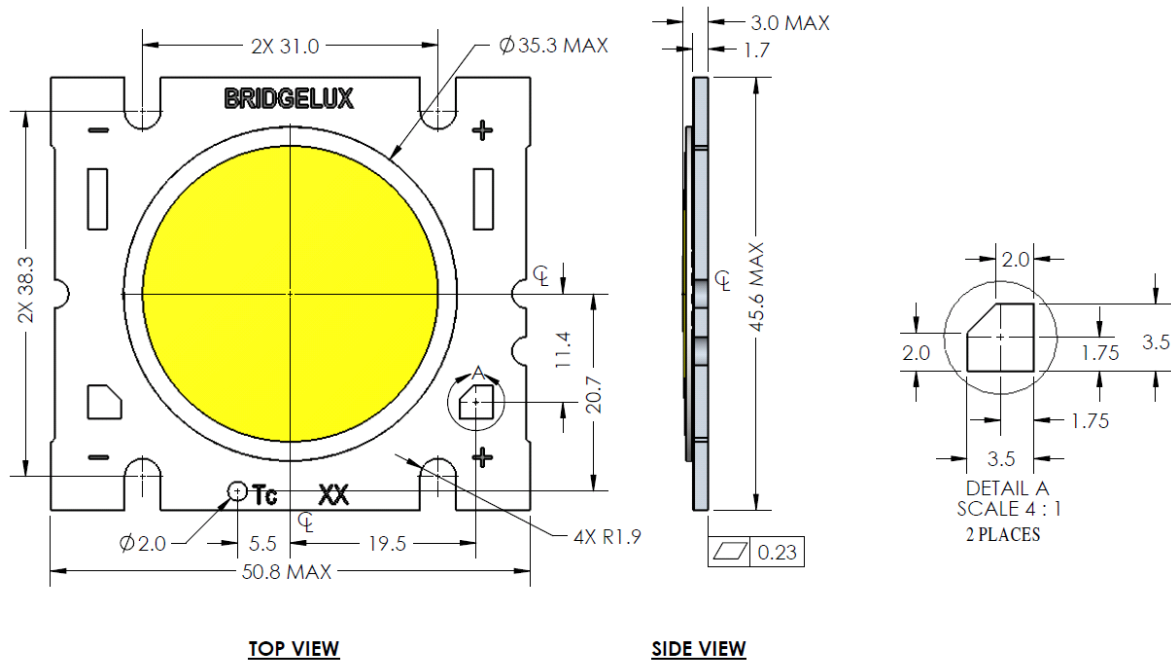

Notes for Figure 1:

1. Slots are for M2.5, M3 or #4 screws.
2. Solder pads are labeled "+" and "-" to denote positive and negative, respectively.
3. It is not necessary to provide electrical connections to both sets of solder pads. Either set of solder pads (6.35 x 2.03 mm rectangular pads or 3.50 mm tapered square pads) may be used depending on application specific design requirements.
4. Drawings are not to scale.
5. Drawing dimensions are in millimeters.
6. Bridgelux recommends four tapped holes for mounting screws – refer to product Application Note AN11 for recommended spacing of holes.
7. Unless otherwise specified, tolerances are ± 0.10 mm.
8. Refer to product Application Notes AN10 and AN11 for product handling, mounting and heat sink recommendations.
9. The optical center of the LED Array is defined by the mechanical center of the array.
10. Bridgelux maintains a flatness of 0.25 mm across the mounting surface of the array. Refer to Application Notes AN10 and AN11 for product handling, mounting and heat sink recommendations.

Typical Radiation Pattern

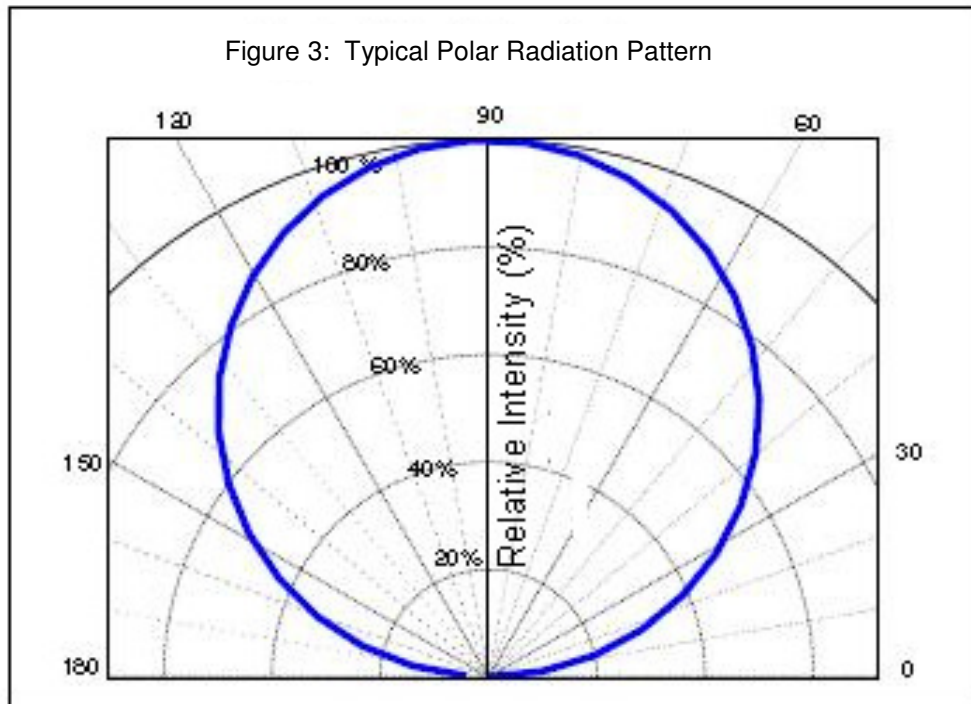
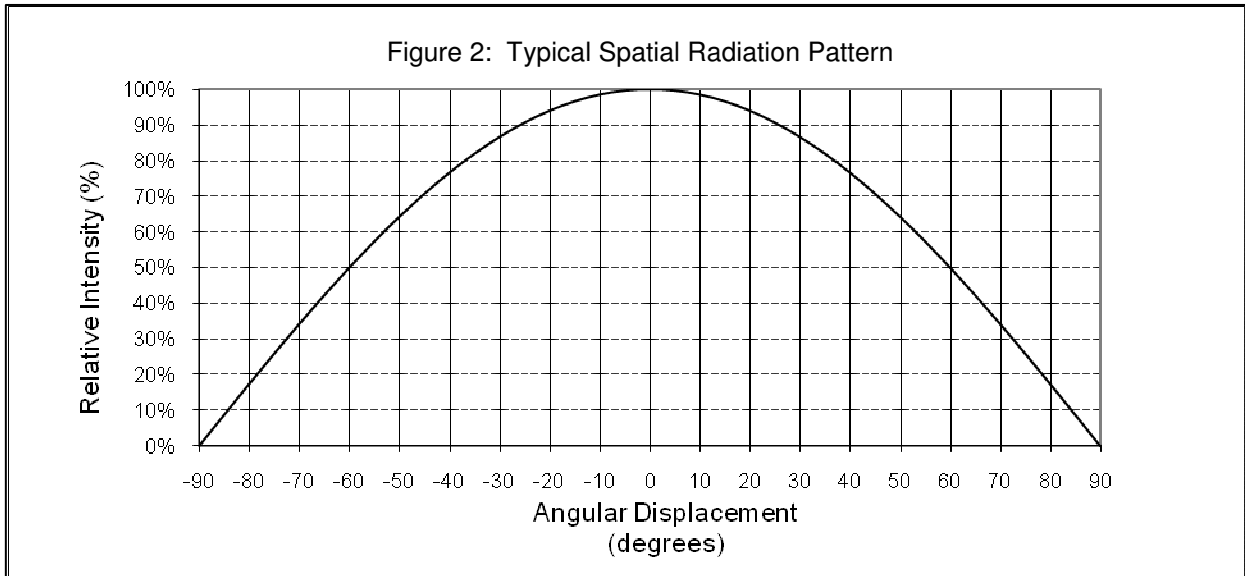

Wavelength Characteristics at Rated Test Current, $T_j=25^\circ\text{C}$

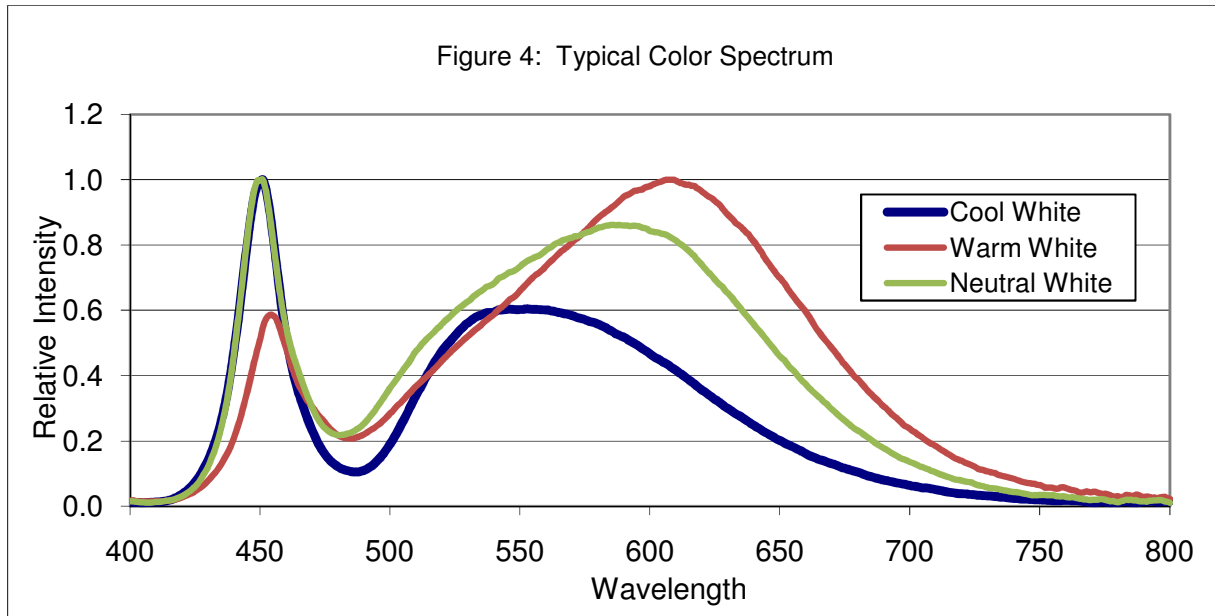

Typical Relative Luminous Flux vs. Current, T_j=25°C

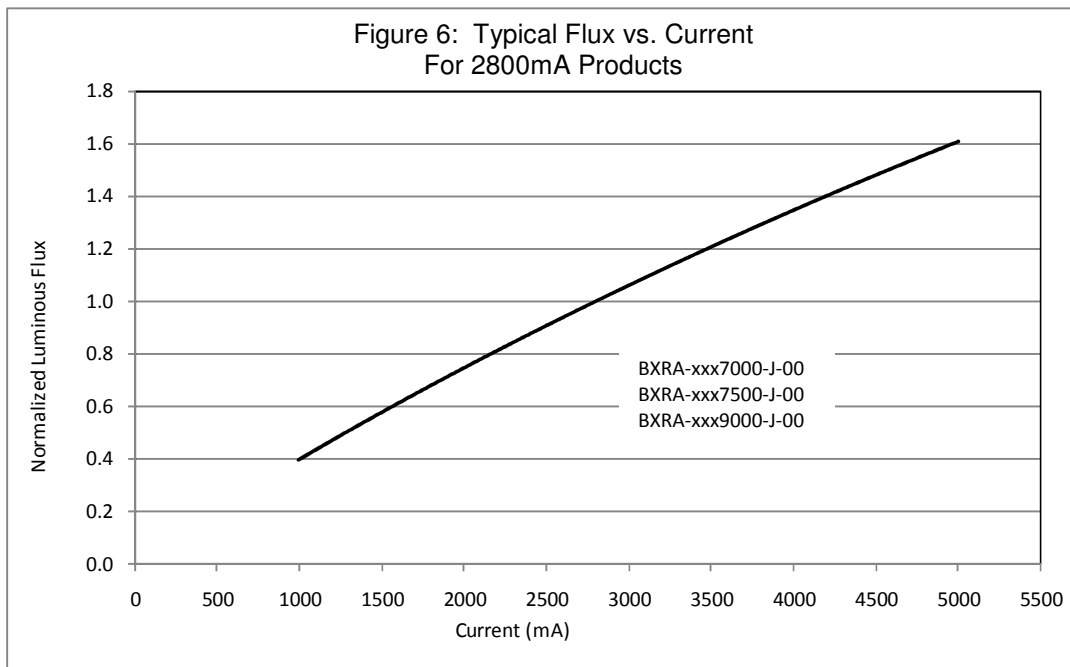
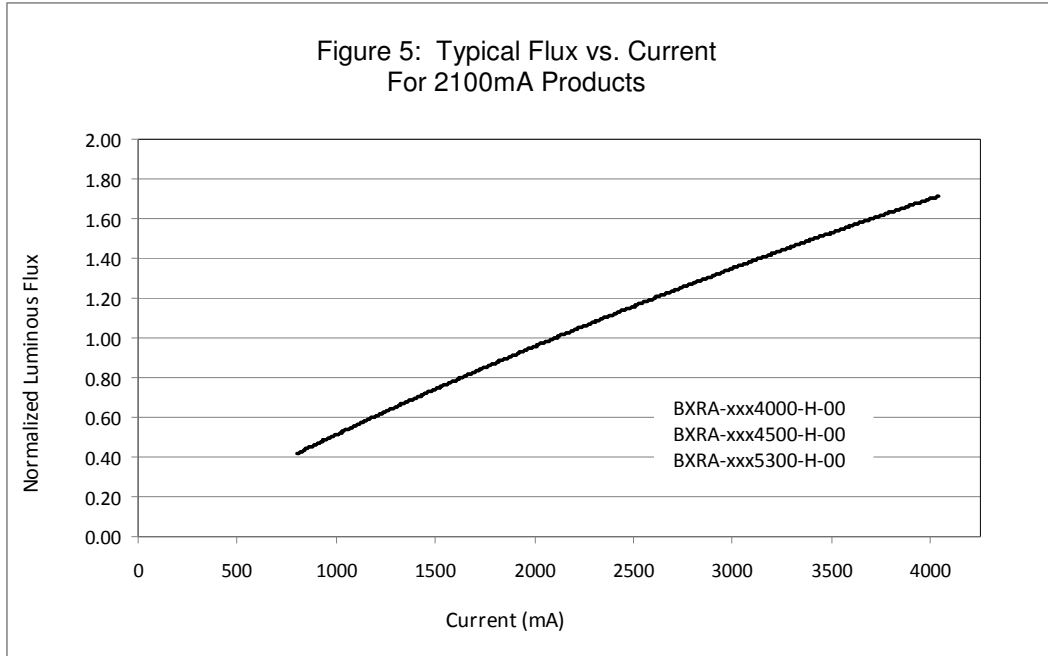

Typical Light Output Characteristics vs. Temperature

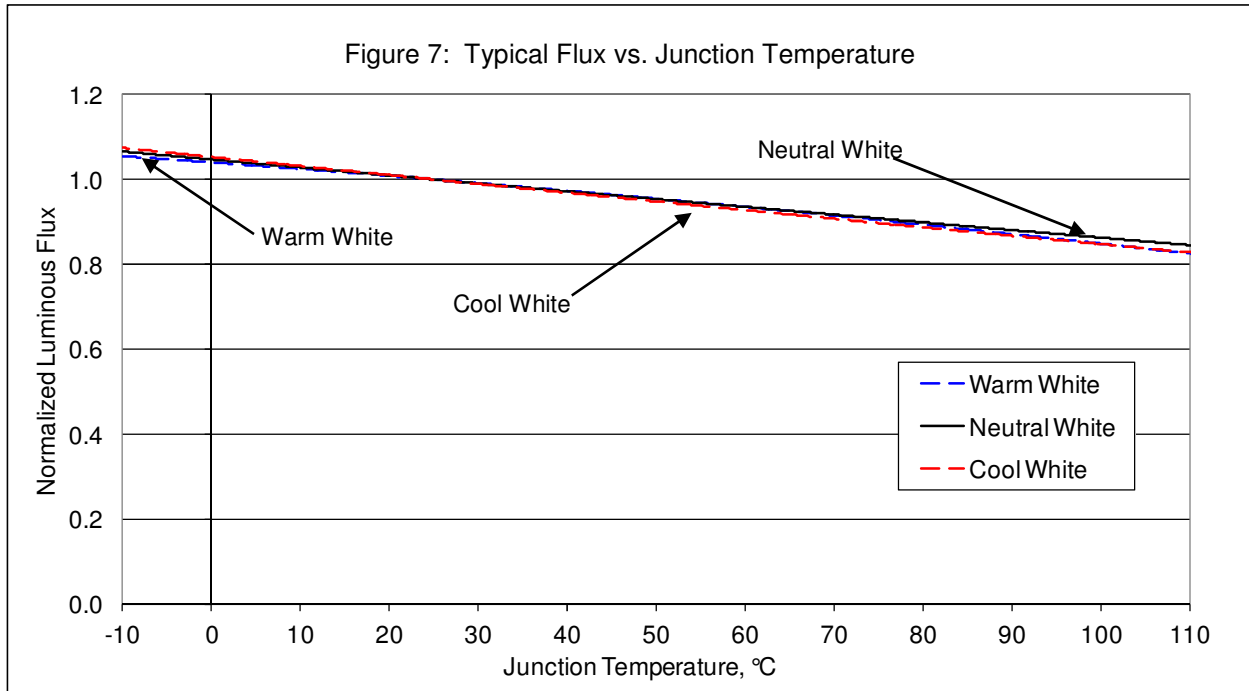

Typical Chromaticity Characteristics vs. Temperature

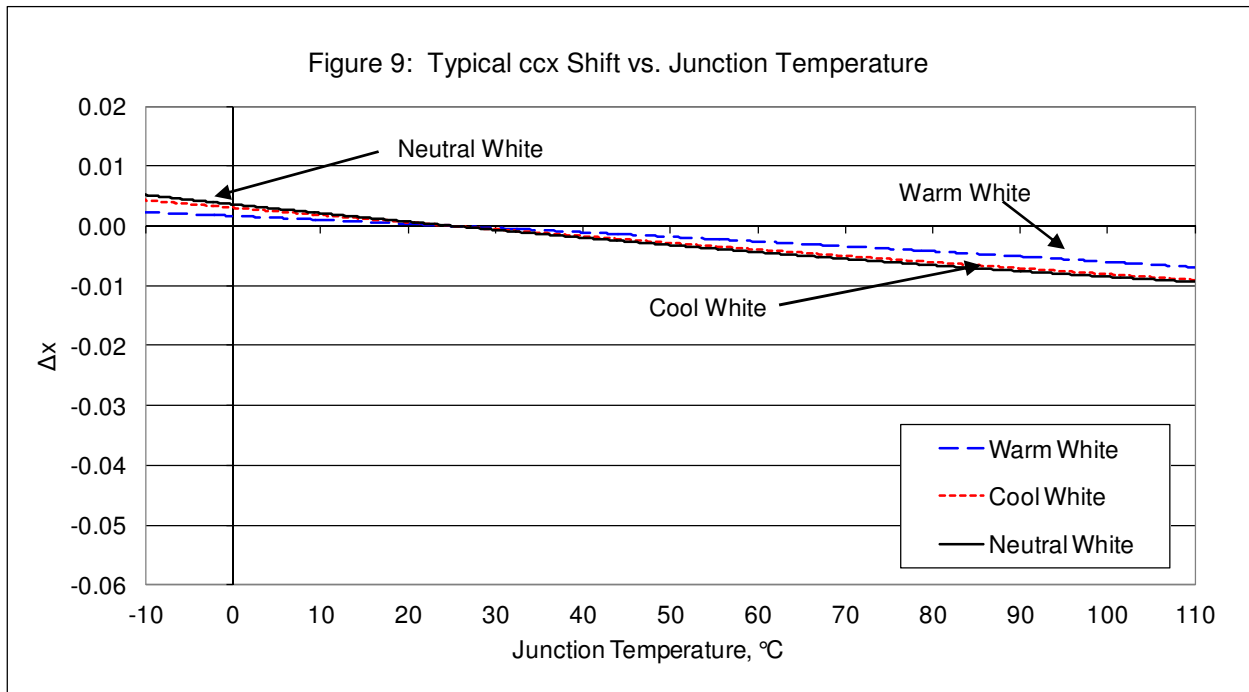
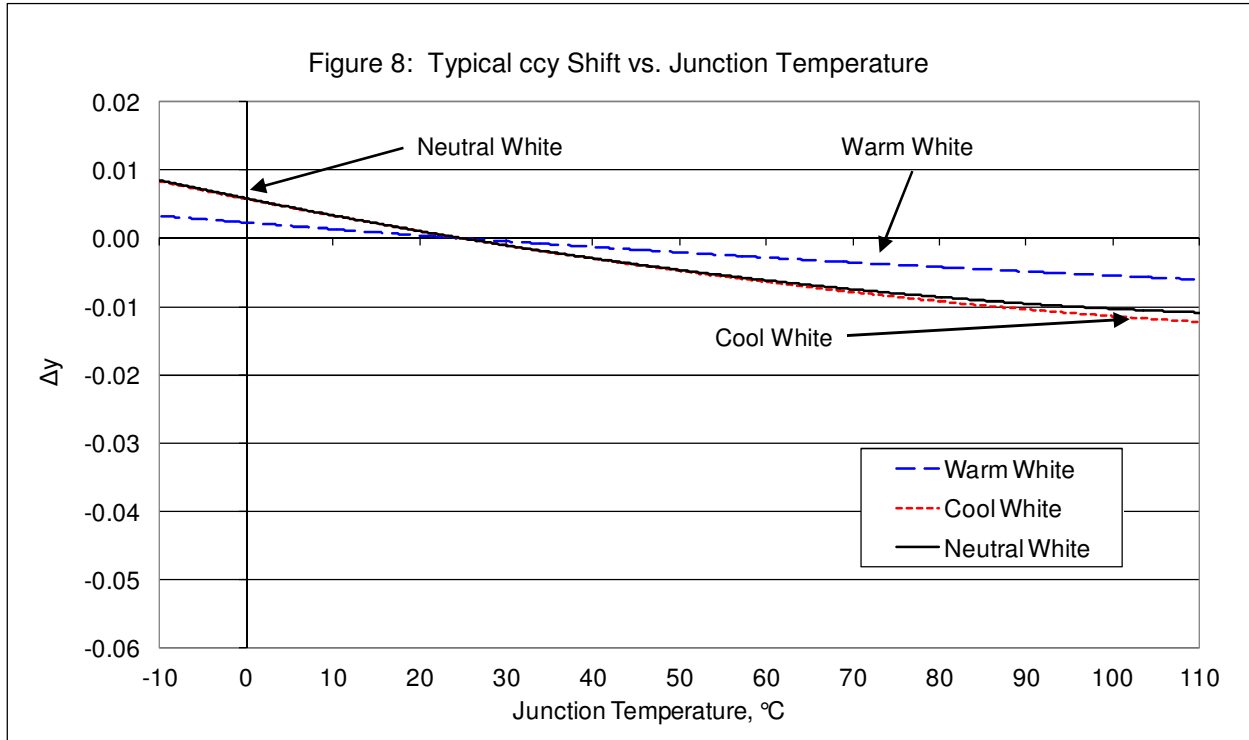

Forward Current Characteristics

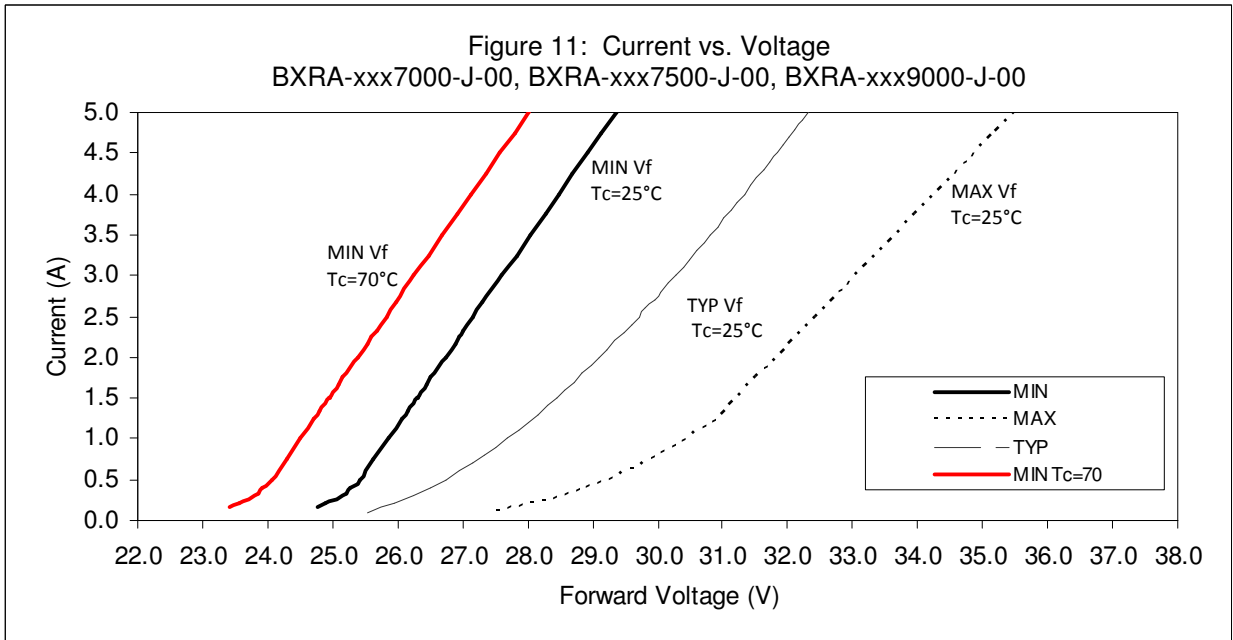
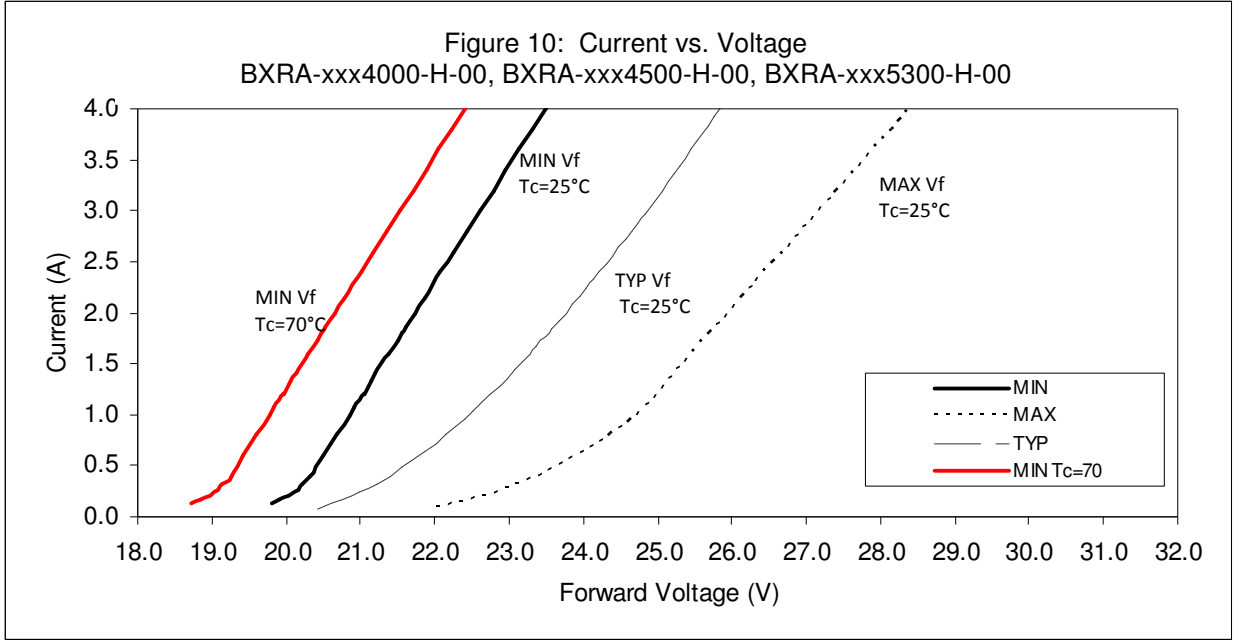

Color Binning Information

Figure 12: Graph of Warm White Test Bins in xy Color Space

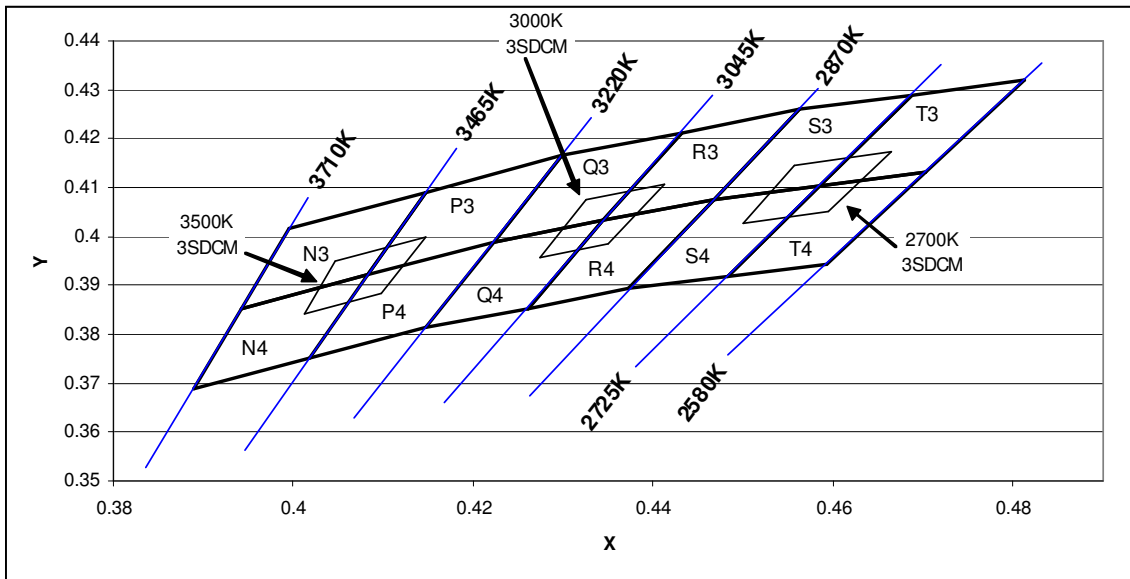

Table 9: Warm White xy Bin Coordinates and Associated Typical CCT

Bin Code	X	Y	ANSI CCT (K)	Bin Code	X	Y	ANSI CCT (K)	Bin Code	X	Y	ANSI CCT (K)
Q3	0.4223	0.3990	3000	S3	0.4468	0.4077	2700	N4	0.3943	0.3853	3500
	0.4299	0.4165			0.4562	0.4260			0.3996	0.4015	
	0.4431	0.4213			0.4688	0.4290			0.4148	0.4090	
	0.4345	0.4033			0.4585	0.4104			0.4083	0.3921	
Q4	0.4147	0.3814	3000	S4	0.4373	0.3893	2700	N3	0.3889	0.3690	3500
	0.4223	0.3990			0.4468	0.4077			0.3943	0.3853	
	0.4345	0.4033			0.4585	0.4104			0.4083	0.3921	
	0.4260	0.3854			0.4483	0.3919			0.4018	0.3752	
R3	0.4345	0.4033	3000	T4	0.4585	0.4104	2700	P3	0.4083	0.3921	3500
	0.4431	0.4213			0.4688	0.4290			0.4148	0.4090	
	0.4562	0.4260			0.4813	0.4319			0.4299	0.4165	
	0.4468	0.4077			0.4703	0.4132			0.4223	0.3990	
R4	0.4260	0.3854	3000	T3	0.4483	0.3919	2700	P4	0.4018	0.3752	3500
	0.4345	0.4033			0.4585	0.4104			0.4083	0.3921	
	0.4468	0.4077			0.4703	0.4132			0.4223	0.3990	
	0.4373	0.3893			0.4593	0.3944			0.4147	0.3814	
X3 (3SDCM)	0.4413	0.4107	3000	X3 (3SDCM)	0.4656	0.4174	2700	X3 (3SDCM)	0.4148	0.4000	3500
	0.4325	0.4075			0.4573	0.4154			0.4047	0.3950	
	0.4274	0.3958			0.4510	0.4032			0.4012	0.3841	
	0.4350	0.3984			0.4583	0.4049			0.4098	0.3883	

Color Binning Information (continued)

Figure 13: Graph of Neutral White Test Bins in xy Color Space

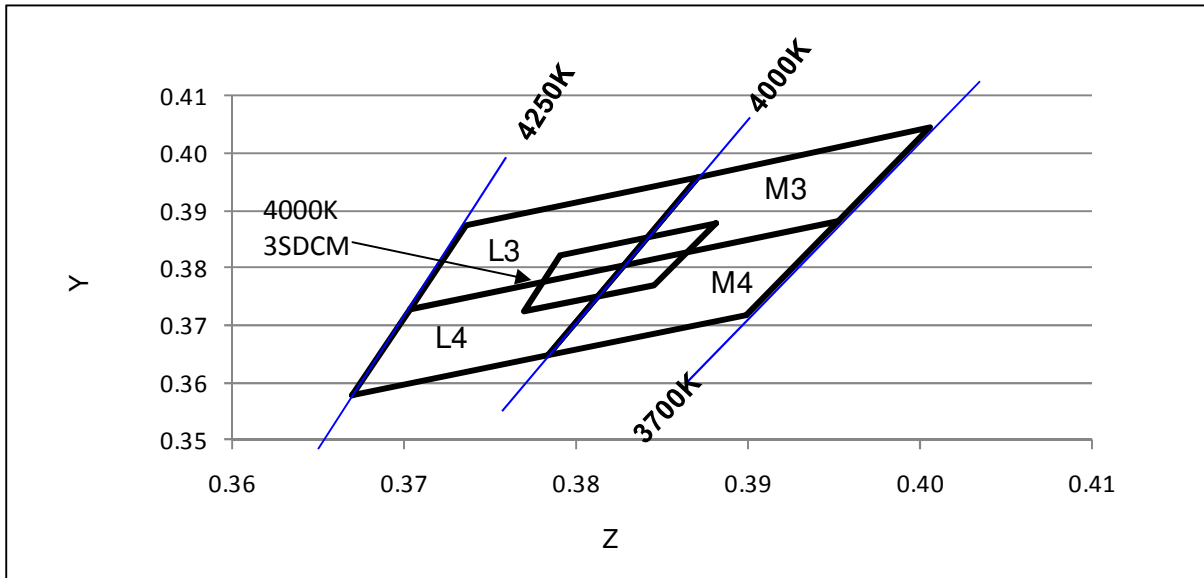

Table 10: Neutral White xy Bin Coordinates and Associated Typical CCT

Bin Code	X	Y	ANSI CCT (K)
L3	0.3703	0.3726	4000
	0.3736	0.3874	
	0.3871	0.3959	
	0.3828	0.3803	
L4	0.3670	0.3578	4000
	0.3703	0.3726	
	0.3828	0.3803	
	0.3784	0.3647	
M3	0.3828	0.3803	4000
	0.3871	0.3959	
	0.4006	0.4044	
	0.3952	0.3880	
M4	0.3784	0.3647	4000
	0.3828	0.3803	
	0.3952	0.3880	
	0.3898	0.3716	
X3 (3SDCM)	0.3881	0.3879	4000
	0.3791	0.3823	
	0.3769	0.3724	
	0.3845	0.3770	

Color Binning Information (continued)

Figure 14: Graph of Cool White Test Bins in xy Color Space

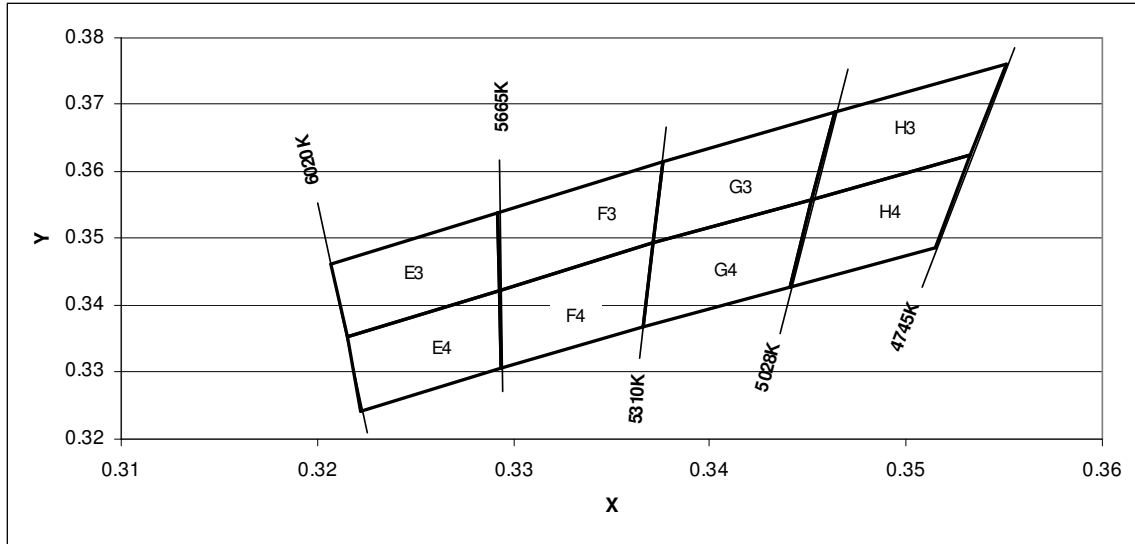

Table 11: Cool White xy Bin Coordinates and Associated Typical CCT

Bin Code	X	Y	ANSI CCT (K)
G3	0.3376	0.3616	5000
	0.3464	0.3688	
	0.3452	0.3558	
	0.3371	0.3493	
G4	0.3371	0.3493	5000
	0.3452	0.3558	
	0.3441	0.3428	
	0.3366	0.3369	
H3	0.3464	0.3688	5000
	0.3551	0.376	
	0.3533	0.3624	
	0.3452	0.3558	
H4	0.3452	0.3558	5000
	0.3533	0.3624	
	0.3515	0.3487	
	0.3441	0.3428	
E3	0.3215	0.3353	5600
	0.3293	0.3423	
	0.3292	0.3539	
	0.3207	0.3462	
E4	0.3222	0.3243	5600
	0.3294	0.3306	
	0.3293	0.3423	
	0.3215	0.3353	
F3	0.3292	0.3539	5600
	0.3293	0.3423	
	0.3371	0.3493	
	0.3376	0.3616	
F4	0.3294	0.3306	5600
	0.3366	0.3369	
	0.3371	0.3493	
	0.3293	0.3423	

Design Resources

Bridgelux has developed a comprehensive set of application notes and design resources to assist customers in successfully designing with Bridgelux LED Array products. Included below is a list of available resources which can be downloaded from the Bridgelux web site under the Design Resources section. These documents are updated regularly as new information becomes available, including complimentary infrastructure products such as commercially available secondary optics and electronic driver solutions.

Application Notes

- AN10: Effective Thermal Management of Bridgelux LED Arrays
- AN11: Assembly Considerations for Bridgelux LED Arrays
- AN12: Electrical Drive Considerations for Bridgelux LED Arrays
- AN14: Reliability Data Sheet for Bridgelux LED Arrays
- AN15: Reflow Soldering of Bridgelux LED Arrays
- AN16: Optical Considerations for Bridgelux LED Arrays

Optical Source Models

Optical source models and ray set files are available for all Bridgelux LED Array products, and can be downloaded directly from the Bridgelux web site. The list below contains the formats currently available. If you require a specific format not included in this list, please contact your Bridgelux sales representative for assistance.

- Zemax
- ASAP
- IESNA
- LightTools
- LucidShape
- OPTIS SPEOS
- PHOTOPIA
- TracePro
- Radiant Imaging Source Model

3D CAD Models

Three dimensional CAD models depicting the product outline of all Bridgelux LED Arrays are available in both SAT and STEP formats. These CAD files can be downloaded directly from the Bridgelux web site.

About Bridgelux

Bridgelux is a leading developer and manufacturer of technologies and solutions transforming the \$40 billion global lighting industry into a \$100 billion market opportunity. Based in Livermore, California, Bridgelux is a pioneer in solid-state lighting (SSL), expanding the market for light-emitting diode (LED) technologies by driving down the cost of LED lighting systems. Bridgelux's patented light source technology replaces traditional technologies (such as incandescent, halogen, fluorescent and high intensity discharge lighting) with integrated, solid-state lighting solutions that enable lamp and luminaire manufacturers to provide high performance and energy-efficient white light for the rapidly growing interior and exterior lighting markets, including street lights, commercial lighting and consumer applications. With more than 550 patent applications filed or granted worldwide, Bridgelux is the only vertically integrated LED manufacturer and developer of solid-state light sources that designs its solutions specifically for the lighting industry.

For more information about the company, please visit www.bridgelux.com

© 2011 Bridgelux, Inc. All rights reserved. Product specifications are subject to change without notice.

