

阅读申明

- 1.本站收集的数据手册和产品资料都来自互联网，版权归原作者所有。如读者和版权方有任何异议请及时告之，我们将妥善解决。
- 2.本站提供的中文数据手册是英文数据手册的中文翻译，其目的是协助用户阅读，该译文无法自动跟随原稿更新，同时也可能存在翻译上的不当。建议读者以英文原稿为参考以便获得更精准的信息。
- 3.本站提供的产品资料，来自厂商的技术支持或者使用者的心得体会等，其内容可能存在描述上的差异，建议读者做出适当判断。
- 4.如需与我们联系，请发邮件到marketing@iczoom.com，主题请标有“数据手册”字样。

Read Statement

1. The datasheets and other product information on the site are all from network reference or other public materials, and the copyright belongs to the original author and original published source. If readers and copyright owners have any objections, please contact us and we will deal with it in a timely manner.
2. The Chinese datasheets provided on the website is a Chinese translation of the English datasheets. Its purpose is for reader's learning exchange only and do not involve commercial purposes. The translation cannot be automatically updated with the original manuscript, and there may also be improper translations. Readers are advised to use the English manuscript as a reference for more accurate information.
3. All product information provided on the website refer to solutions from manufacturers' technical support or users the contents may have differences in description, and readers are advised to take the original article as the standard.
4. If you have any questions, please contact us at marketing@iczoom.com and mark the subject with "Datasheets" .

Surface Mount Cermet Trimmers (single turn)

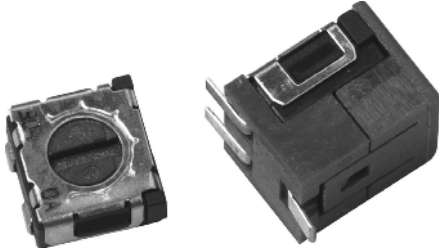

FEATURES

- Lead (Pb)-free soldering, Cadmium-free
- Wide variety (7 types) to choose from
- Automatic mounting is possible (Taping)
- Flow/reflow soldering is possible
- Sealed construction (Washable)
- Stopper structure prevents terminal pin from being open
- Cross slot totor suitable for automatic adjustment
- RoHS compliant



DIMENSIONS in millimeters

RECOMMENDED P.C.B. PAD OUTLINE DIMENSIONS

ST-4A, 4EA

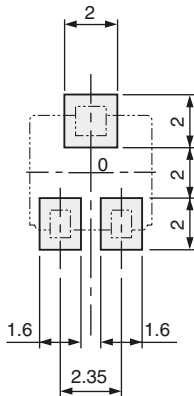

ST-4B, 4EB

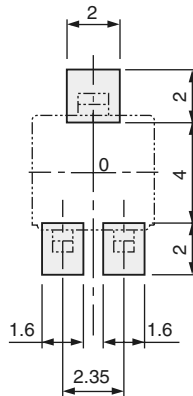

ST-4D, 4ED

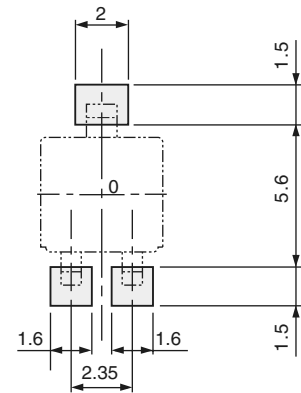

(Unit: mm)

ST-4G, 4EG

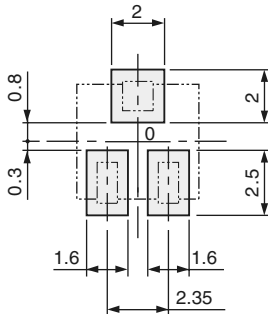

ST-4H, 4EH

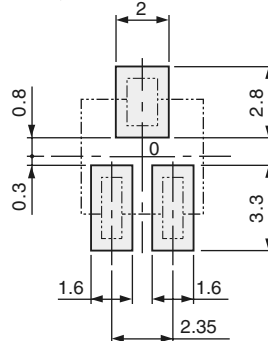

Note) The zero point is the center of mounting.

Specifications are subject to change without notice. Specifications in this catalog are for reference. The formal specification sheets will be submitted upon request.

DIMENSIONS in millimeters

Unless otherwise specified, tolerance: ± 0.3 (Unit: mm)

OUTLINE DIMENSIONS

ST-4A, 4EA
Top adjustment

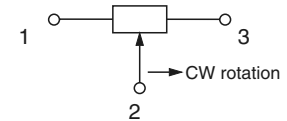
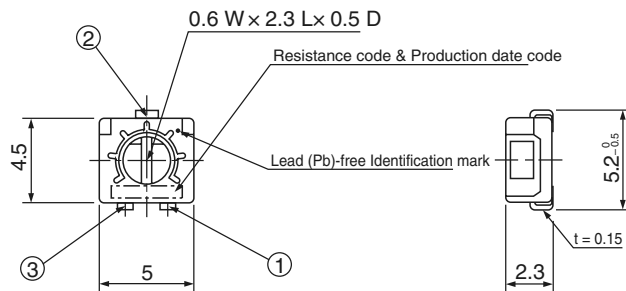

*: Note the terminal position.

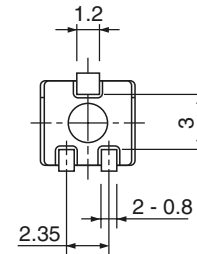

ST-4B, 4EB
Top adjustment

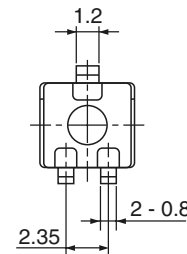
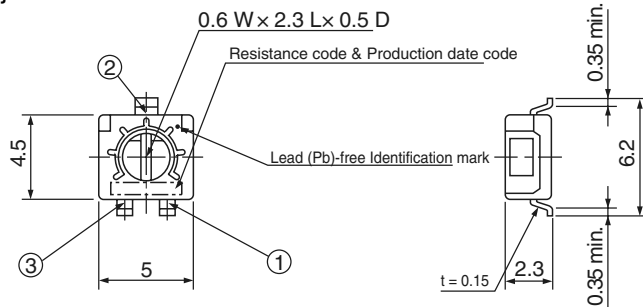

ST-4C, 4EC
Top adjustment

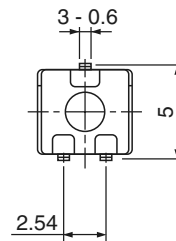
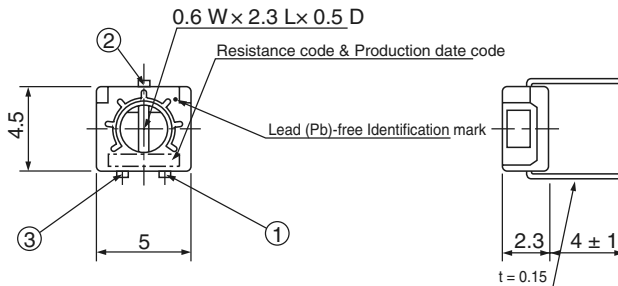

ST-4G, 4EG
Side adjustment

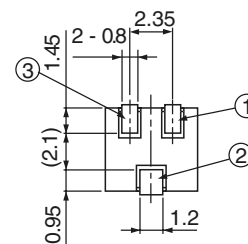
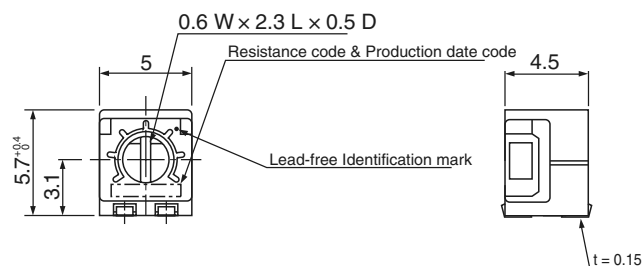

Specifications are subject to change without notice. Specifications in this catalog are for reference. The formal specification sheets will be submitted upon request.

DIMENSIONS in millimeters

OUTLINE DIMENSIONS

Unless otherwise specified, tolerance: ± 0.3 (Unit: mm)

ST-4H, 4EH
Side adjustment

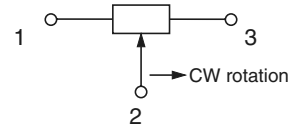
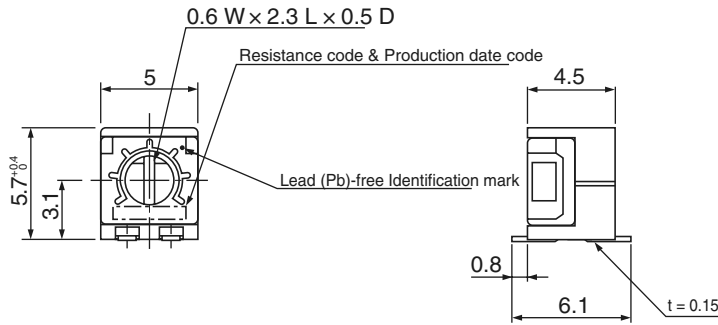

*: Note the terminal position.

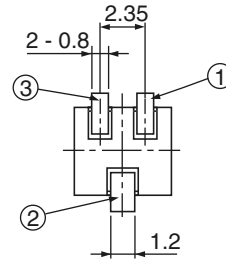

ST-4D, 4ED
Rear adjustment

<Semi-standard products>

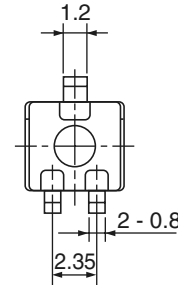
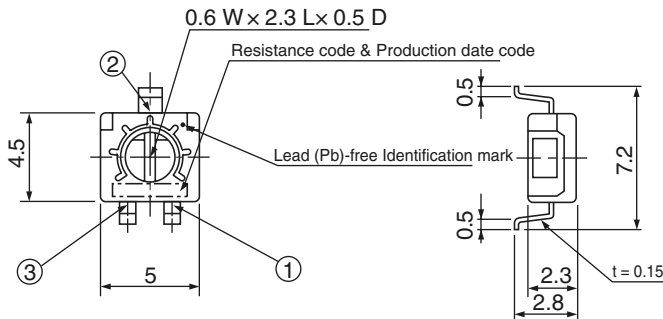

ST-4F, 4EF
Rear adjustment

<Semi-standard products>

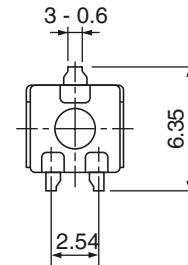
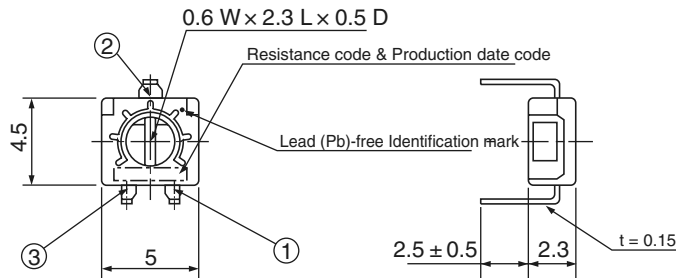

ST-42, 42E
CROSS SLOT DIMENSION

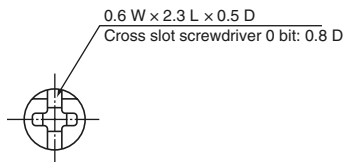

Specifications are subject to change without notice. Specifications in this catalog are for reference. The formal specification sheets will be submitted upon request.

PACKAGING SPECIFICATIONS

Taping packaging specifications

- Taping version is packaged in 500 pcs. per reel.
- Orders will be accepted for units of 500 pcs., i.e., 500, 1000, 1500 pcs., etc.
- ST-4TA, TB, TD, ETA, ETB and ETD versions are boxed with 4 reels (2000 pcs.).
- ST-4TG, TH, ETG and ETH versions are boxed with one reel (500 pcs.).

Maximum number of consecutive missing pieces = 2
 Leader length and reel dimension are shown in the dia-grams below.

EMBOSSED TAPE DIMENSIONS

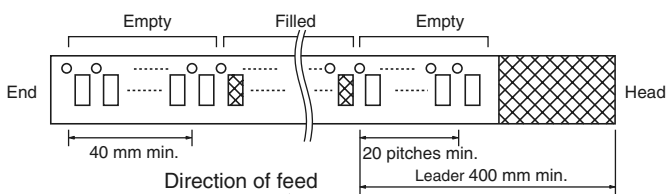

REEL DIMENSIONS

(Conforms to JIS C 0806-3)
 (In accordance with EIAJ ET-7200A)

(Unit: mm)

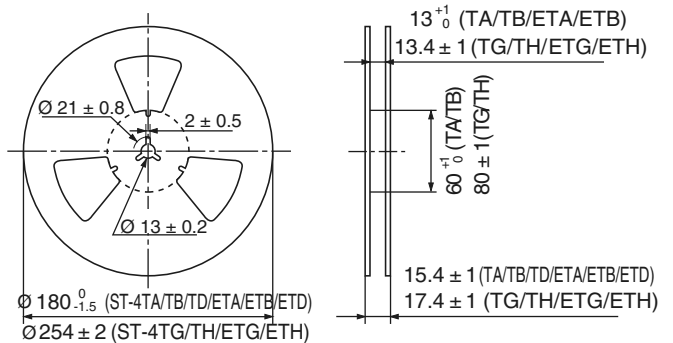

ST-4TA/TB/TD/ETA/ETB/ETD

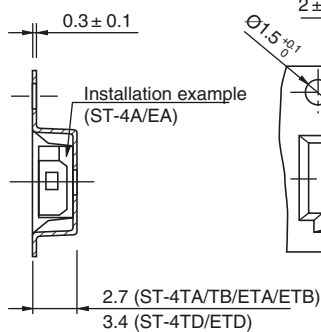
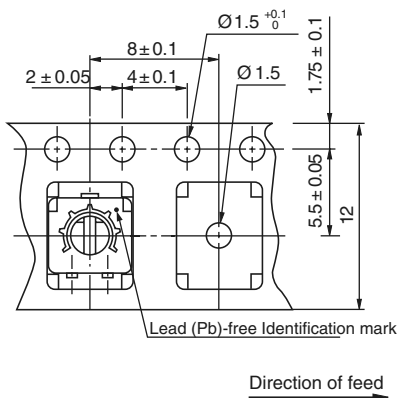

ST-4TG/TH/ETG/ETH

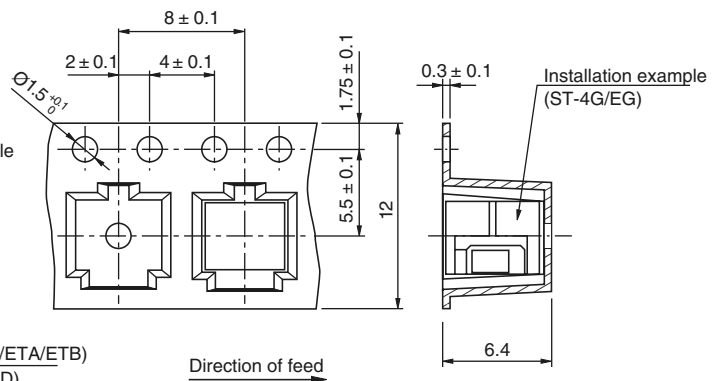

Vinyl bag packaging specifications

- Unit of bulk in vinyl bag packaging is 100 pcs. per pack.
- Boxing of bulk in vinyl bags is performed with 500 pcs. per box.



MECHANICAL SPECIFICATIONS

Mechanical angle	240° (1 turn)
Operating torque	10 mN m {102 gf cm} maximum
Stop strength	30 mN m {306 gf cm} minimum
Rotational life	100 cycles [$\Delta R/R \leq \pm (2 \Omega + 3 \%)$]
Thrust to rotor	5 N {0.51 kgf} minimum
Solderability	Sn-Pb: 235 °C, 2 s Sn-Cu (Lead (Pb)-free): 245 ± 3 °C, 2 ~ 3 s
Shear (Adhesion)	5 N {0.51 kgf} 10 s
Substrate bending	Width 90 mm, bend 3 mm, 5 s, 1 time
Pull-off strength	5 N {0.51 kgf} 10 s

ELECTRICAL SPECIFICATIONS

Nominal resistance range	10 Ω ~ 2 M Ω
Resistance tolerance	± 20 %
Power ratings	0.25 W (70 °C) 0 W (125 °C)
Resistance law	Linear law (B)
Maximum input voltage	DC200 V or power rating, whichever is smaller
Maximum wiper current	100 mA or power rating, whichever is smaller
Effective electrical turn	210° (1 turn)
End resistance	1 % or 2 Ω , whichever is greater
C.R.V.	1 % or 3 Ω , whichever is greater
Operating temp. range	- 55 ~ 125 °C
Temp. coefficient	10 Ω ~ 50 Ω : ± 250 10 ⁻⁶ /°C maximum 100 Ω ~ 2M Ω : ± 100 10 ⁻⁶ /°C maximum
Insulation resistance	1000 M Ω minimum (DC500 V)
Dielectric strength	AC500 V, 60 s
Net weight	Approx. 0.12 g (ST-4A, B, C, D, F, EA, EB, EC, ED, EF) Approx. 0.22 g (ST-4G, H, EG, EH)

ENVIRONMENTAL SPECIFICATIONS

Test item	Test conditions	Specifications
Thermal shock	- 65 ~ 125 °C (0.5 h), 5 cycles	[$\Delta R/R \leq 2 \%$] [S.S. ≤ 1 %]
Humidity	- 10 ~ 65 °C (Relative humidity 80 ~ 98 %), 10 cycles, 240 h	[$\Delta R/R \leq 2 \%$]
Shock	981 m/s ² , 6 ms 6 directions for 3 times each	[$\Delta R/R \leq 1\%$] [S.S. ≤ 1 %]
Vibration	Amplitude 1.52 mm or Acceleration 196 m/s ² , 10 ~ 2000 Hz, 3 directions, 12 times each	
Load Life	70 °C, 0.25 W, 1000 h	[$\Delta R/R \leq 3 \%$] [S.S. ≤ 1 %]
Low temperature operation	- 55 °C, 2 h	[$\Delta R/R \leq 2 \%$] [S.S. ≤ 2 %]
High temperature exposure	125 °C, 250 h	[$\Delta R/R \leq 3 \%$] [S.S. ≤ 2 %]
Immersion seal	85 °C, 60 s	No leaks (No continuous bubbles)
Soldering heat	Sn-Pb 260 °C, 10 s or 215 °C, 35 s Sn-Cu Flow: 260 °C ± 3 °C as the temperature in a pot of molten solder, immersion from head of terminal to backside of board, 5 ~ 6 s, two times maximum Reflow: Peak temperature 255 °C (Please refer to the profile below.) Manual soldering: 350 ± 10 °C, 3 ~ 4 s	[$\Delta R/R \leq 1 \%$]

Reflow profile for soldering heat evolution

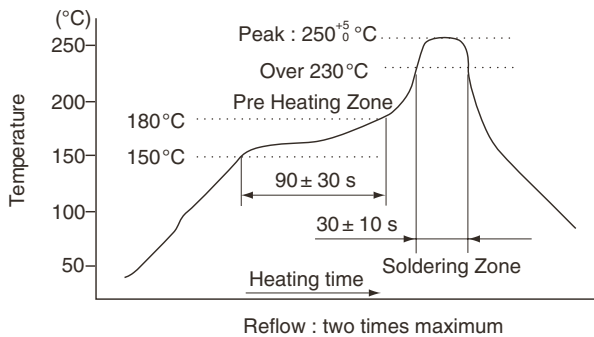

MAXIMUM INPUT RATINGS			
Nominal resistance values (Ω)	Resistance code	Maximum input voltage (V)	Maximum wiper current (mA)
10*	100	1.00	100
20*	200	2.00	100
50	500	3.53	70.7
100	101	5.00	50.0
200	201	7.07	35.4
500	501	11.2	22.4
1 k	102	15.8	15.8
2 k	202	22.4	11.2
5 k	502	35.4	7.07
10 k	103	50.0	5.00
20 k	203	70.7	3.54
50 k	503	112	2.24
100 k	104	158	1.58
200 k	204	200	1.00
500 k	504	200	0.40
1 M	105	200	0.20
2 M	205	200	0.10

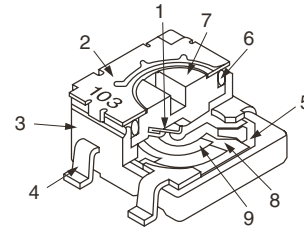

CONSTRUCTION				
Part Name		Material	Flammability	
1	Wiper	Multi metal alloy	-	
2	Cover	Stainless steel (SUS 304)		
3	Housing	Epoxy	UL-94V-O	
4	Terminal pin	Sn-Pb	Copper alloy, Solder-plated	-
		Sn-Cu	Copper alloy, Sn-Cu-plated	
5	Base element	Ceramic		
6	"O" ring	Silicone rubber	UL-94HB	
7	Rotor	Polyphenylenesulphide	UL-94V-O	
8	Electrode	Ag-Pd cermet	-	
9	Resistive element	RuO2 cermet		

The products indicated by * mark are manufactured upon receipt of order basis

CFC's, Halon, Carbon tetrachloride and designated bromic flame retardant PBBs and PBBs are not used in our products.

LIST OF PART NUMBERS					
Adjustment position	Shape of terminal	Form of packing			
		Taping (reel)		Magazine (stick)	
		Sn-Pb	Sn (Lead (Pb)-free)	Sn-Pb	Sn (Lead (Pb)-free)
Top adjustment	A (J-hook)	ST-4/42TA	ST-4/42ETA	ST-4/42A	ST-4/42EA
	B (Gull wing)	ST-4/42TB	ST-4/42ETB	ST-4/42B	ST-4/42EB
	C (Through hole pins)	-	-	ST-4/42C	ST-4/42EC
Rear adjustment	D (Gull-wing)	ST-4/42TD*	ST-4/42ETD*	ST-4/42D*	ST-4/42ED*
	F (Through hole pins)	-	-	ST-4/42F*	ST-4/42EF*
Side adjustment	G (J-hook)	ST-54/42TG	ST-4/42ETG	ST-4/42G	ST-4/42EG
	H (Gull-wing)	ST-4/42TH	ST-4/42ETH	ST-4/42H	ST-4/42EH
Pieces in package		500 pcs./reel		100 pcs./reel	

The products indicated by * mark are manufactured upon receipt of order basis.

* Slot: ST-4 □ □ Slot: -42 □ □



FIG.1: NOMINAL RESISTANCE VALUES								
10 Ω*	20 Ω*	50 Ω	100 Ω	200 Ω	500 Ω	1 kΩ	2 kΩ	5 kΩ
10 kΩ	20 kΩ	50 kΩ	100 kΩ	200 kΩ	500 kΩ	1 MΩ	2 MΩ	-

Not manufactured

* The above part numbers are all available with the respective combination of <Nominal resistance values> (Fig.1)

* Verify the above part numbers when placing orders.

* Taping specification is not sold separately and must be purchased in reel units.

ORDERING INFORMATION				
ST-4		T	A	204
SERIES NAME (MINUS SLOT)	TERMINAL PIN	FORM OF PACKAGING	PRODUCT SHAPE (SHAPE OF TERMINAL)	RESISTANCE CODE
	Blank: Sn-Pb E: Sn (Lead(Pb)-free)	T: Taping (Reel) Blank: Bulk in vinyl bags	A, G: J-hook B, D, H: Gull wing C; F: Through hole pins	

ORDERING INFORMATION				
ST-4 2		T	A	204
SERIES NAME (CROSS SLOT)	TERMINAL PIN	FORM OF PACKAGING	PRODUCT SHAPE (SHAPE OF TERMINAL)	RESISTANCE CODE
	Blank: Sn-Pb E: Sn (Lead-free)	T: Taping (Reel) Blank: Bulk in vinyl bags	A, G: J-hook B, D, H: Gull wing C; F: Through hole pins	

This product is manufactured by Copal Electronics Co. Ltd. of Tokyo, Japan and is distributed by Vishay in North and South America only. This product is not available from Vishay outside of North or South America.



Notice

Specifications of the products displayed herein are subject to change without notice. Vishay Intertechnology, Inc., or anyone on its behalf, assumes no responsibility or liability for any errors or inaccuracies.

Information contained herein is intended to provide a product description only. No license, express or implied, by estoppel or otherwise, to any intellectual property rights is granted by this document. Except as provided in Vishay's terms and conditions of sale for such products, Vishay assumes no liability whatsoever, and disclaims any express or implied warranty, relating to sale and/or use of Vishay products including liability or warranties relating to fitness for a particular purpose, merchantability, or infringement of any patent, copyright, or other intellectual property right.

The products shown herein are not designed for use in medical, life-saving, or life-sustaining applications. Customers using or selling these products for use in such applications do so at their own risk and agree to fully indemnify Vishay for any damages resulting from such improper use or sale.