

阅读申明

- 1.本站收集的数据手册和产品资料都来自互联网，版权归原作者所有。如读者和版权方有任何异议请及时告之，我们将妥善解决。
- 2.本站提供的中文数据手册是英文数据手册的中文翻译，其目的是协助用户阅读，该译文无法自动跟随原稿更新，同时也可能存在翻译上的不当。建议读者以英文原稿为参考以便获得更精准的信息。
- 3.本站提供的产品资料，来自厂商的技术支持或者使用者的心得体会等，其内容可能存在描述上的差异，建议读者做出适当判断。
- 4.如需与我们联系，请发邮件到marketing@iczoom.com，主题请标有“数据手册”字样。

Read Statement

1. The datasheets and other product information on the site are all from network reference or other public materials, and the copyright belongs to the original author and original published source. If readers and copyright owners have any objections, please contact us and we will deal with it in a timely manner.
2. The Chinese datasheets provided on the website is a Chinese translation of the English datasheets. Its purpose is for reader's learning exchange only and do not involve commercial purposes. The translation cannot be automatically updated with the original manuscript, and there may also be improper translations. Readers are advised to use the English manuscript as a reference for more accurate information.
3. All product information provided on the website refer to solutions from manufacturers' technical support or users the contents may have differences in description, and readers are advised to take the original article as the standard.
4. If you have any questions, please contact us at marketing@iczoom.com and mark the subject with "Datasheets" .



KB10

10 Watt Single and Dual Output, PCB Mountable AC/DC Switching Power Supply



FEATURES

- PC BOARD MOUNTABLE
- SUPER SMALL SIZE
- HIGH POWER DENSITY
- UNIVERSAL INPUT / "CE-MARK"
- HIGH RELIABILITY
- OVERCURRENT PROTECTION
- TWO YEAR WARRANTY

SAFETIES / EMI



FCC Part 15-B
EN 55022-B

ELECTRICAL SPECIFICATIONS

All specifications are typical at nominal input, full load.

INPUT SPECIFICATIONS

Input Voltage.....	AC 85V-264V
Input Frequency.....	47-63 Hz
Input Current.....	Vin= 115v 0.18A
	Vin= 230v 0.12A
Inrush Current.....	Vin= 100v 3.2A
	Vin= 230v 7.5A

OUTPUT SPECIFICATIONS

Output Voltage.....	See Chart
Output Adjustment.....	No Adjustment
Efficiency.....	75~80%
Over-Voltage Protection.....	N/A
Over-Current Protection.....	Automatic Recovery (105% min)
Ripple and Noise.....	150 mVp-p (typ.)
Hold-Up Time.....	Vin= 100v 11mSec
	Vin= 230v 90mSec
Line/Load Regulation.....	0.4% / 1% (MAX)
Rise Time.....	Vin= 100v 130mSec
	Vin= 230v 115mSec
Leakage Current.....	Vin= 100v 0.12 m Arms
	Vin= 230v 0.26 m Arms

GENERAL SPECIFICATIONS

Switching Frequency.....	100 KHz Typ
MTBF.....	>280,000 Hours Typ
Isolation Voltage	
Primary to Secondary.....	3000 VAC
Primary to Case.....	1500 VAC
Secondary to Case.....	500 VAC
Isolation Resistance.....	100 MΩ

ENVIRONMENTAL SPECIFICATIONS

Operating Temperature	0°C ~ +60°C
	Derates linearly 2.5%/°C after 50°C
Cooling.....	Convection
Temperature Coefficient.....	0.02% / °C
Humidity.....	20~85% Rh
Storage Temperature.....	-20° ~ +85°C
Shock/Vibration.....	Shock: 20G (3 Directions each 3 times)
	Vibration: 1~55Hz

PHYSICAL SPECIFICATIONS

Board Level Encapsulated
 Thru- hole Pins

Series



MODEL	INPUT RATING	OUTPUT VOLTAGE	OUTPUT CURRENT	EFFICIENCY AT 100% LOAD (TYP.)
KB10-05S	115-230 V 50-60 HZ	5 VDC	0 ~ 2.0 A	75%
KB10-12S	115-230 V 50-60 HZ	12 VDC	0 ~ 0.9 A	80%
KB10-15S	115-230 V 50-60 HZ	15 VDC	0 ~ 0.7 A	80%
KB10-24S	115-230 V 50-60 HZ	24 VDC	0 ~ 450 mA	80%
KB10-122D	115-230 V 50-60 HZ	± 12 VDC	±45 ~ 450 mA	80%
KB10-153D	115-230 V 50-60 HZ	± 15 VDC	±35 ~ 350 mA	80%

KB10 Series

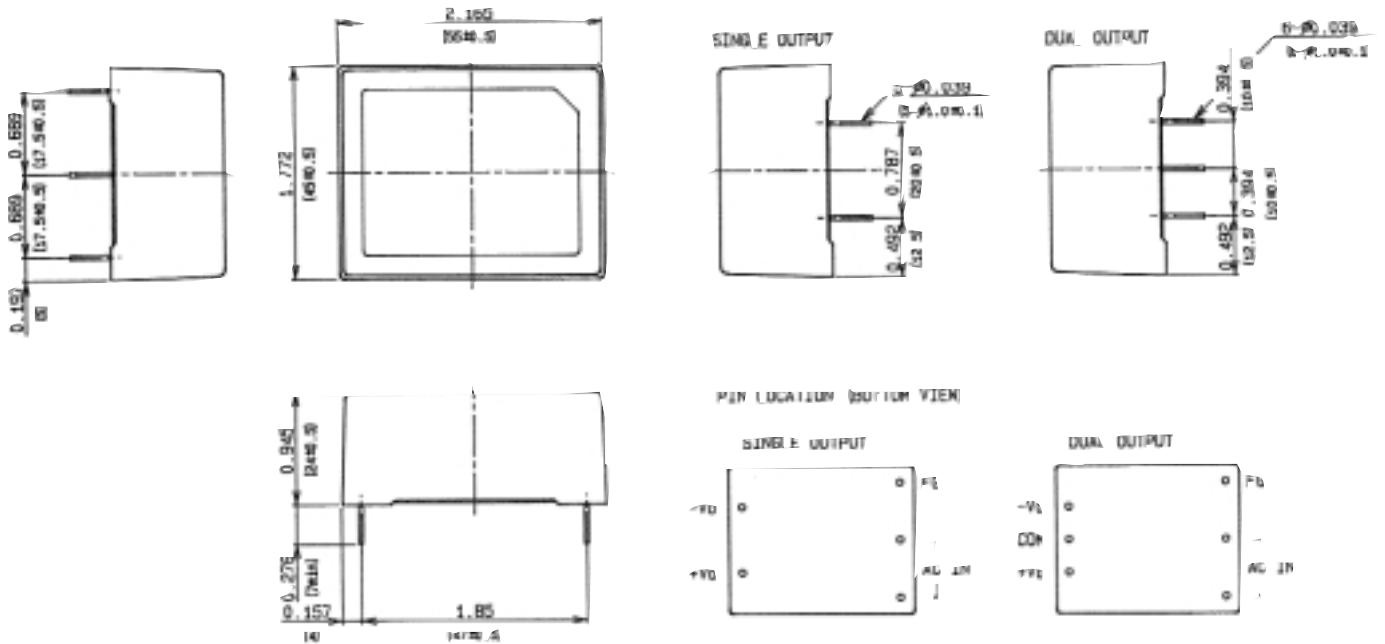

NOTE
 1. TOLERANCE ±0.075mm.
 A. DIMENSION IN INCH (mm)

NOTE:
 All specifications typical and nominal / full load and 25°C unless otherwise noted.
 Avoid sustained operation in overload or dead short conditions.
 Specifications subject to changes without notice.

• Dimensions in mm

