

## 阅读申明

- 1.本站收集的数据手册和产品资料都来自互联网，版权归原作者所有。如读者和版权方有任何异议请及时告之，我们将妥善解决。
- 2.本站提供的中文数据手册是英文数据手册的中文翻译，其目的是协助用户阅读，该译文无法自动跟随原稿更新，同时也可能存在翻译上的不当。建议读者以英文原稿为参考以便获得更精准的信息。
- 3.本站提供的产品资料，来自厂商的技术支持或者使用者的心得体会等，其内容可能存在描述上的差异，建议读者做出适当判断。
- 4.如需与我们联系，请发邮件到marketing@iczoom.com，主题请标有“数据手册”字样。

## Read Statement

1. The datasheets and other product information on the site are all from network reference or other public materials, and the copyright belongs to the original author and original published source. If readers and copyright owners have any objections, please contact us and we will deal with it in a timely manner.
2. The Chinese datasheets provided on the website is a Chinese translation of the English datasheets. Its purpose is for reader's learning exchange only and do not involve commercial purposes. The translation cannot be automatically updated with the original manuscript, and there may also be improper translations. Readers are advised to use the English manuscript as a reference for more accurate information.
3. All product information provided on the website refer to solutions from manufacturers' technical support or users the contents may have differences in description, and readers are advised to take the original article as the standard.
4. If you have any questions, please contact us at marketing@iczoom.com and mark the subject with "Datasheets" .

## Chip Resistor Array

Type: **EXB 14V, 18V, 24V, 28V, N8V, 2HV, 34V, V4V, 38V, V8V, S8V**

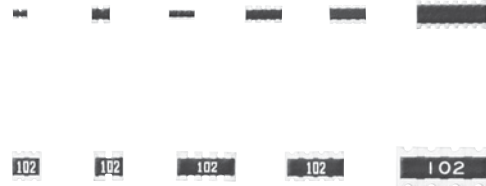

### Features

- High density  
 2 resistors in 0.8 mm × 0.6 mm size / 0302 inch size : EXB14V  
 4 resistors in 1.4 mm × 0.6 mm size / 0502 inch size : EXB18V  
 2 resistors in 1.0 mm × 1.0 mm size / 0404 inch size : EXB24V  
 4 resistors in 2.0 mm × 1.0 mm size / 0804 inch size : EXB28V, EXBN8V  
 8 resistors in 3.8 mm × 1.6 mm size / 1506 inch size : EXB2HV  
 2 resistors in 1.6 mm × 1.6 mm size / 0606 inch size : EXB34V, EXBV4V  
 4 resistors in 3.2 mm × 1.6 mm size / 1206 inch size : EXB38V, EXBV8V  
 4 resistors in 5.1 mm × 2.2 mm size / 2009 inch size : EXBS8V
- Improvement of placement efficiency  
 Placement efficiency of Chip Resistor Array is two, four or eight times of the flat type chip resistor
- Reference Standard...IEC 60115-9, JIS C 5201-9, EIAJ RC-2129
- AEC-Q200 qualified (EXB2, EXB3)
- RoHS compliant

■ **As for Packaging Methods, Land Pattern, Soldering Conditions and Safety Precautions,**  
 Please see Data Files

### Explanation of Part Numbers

1	2	3	4	5	6	7	8	9	10	11
E	X	B	V	8	V	4	7	2	J	V
Product Code	Size and construction		No. of Terminal	Schematics	Resistance Value	Resistance Tolerance	Packaging Methods			
Thick Film Chip Resistor Networks	Code	Inch	Terminal type		The first two digits are significant figures of resistance value and the third one denotes the number of zeros following. Jumper is expressed by R00 Example : 222 → 2.2 kΩ	J ±5 % 0 Jumper	Code	Packaging	Part No.	
	1	0201 Array	Convex/Flat Terminal	4 4 Terminal 8 8 Terminal H 16 Terminal			Nil	Embossed Carrier Taping 4 mm pitch, 2,500 pcs.	EXBS8V	
	2	0402 Array	Convex Terminal				X	Punched Carrier Taping 2 mm pitch, 10,000 pcs.	EXB14V, 18V, 24V, 28V, N8V	
	3	0603 Array	Terminal				V	Punched Carrier Taping 4 mm pitch, 5,000 pcs.	EXB2HV, 34V, 38V, V4V, V8V	
	N	0402 Array	Concave Terminal							
	V	0603 Array	Terminal							
	S	0805 Array	Terminal							

### Construction (Example : Concave Terminal)

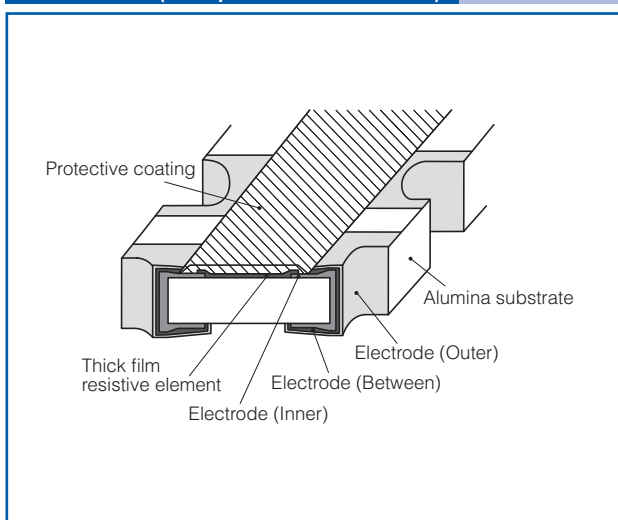

### Schematics

- Isolated type

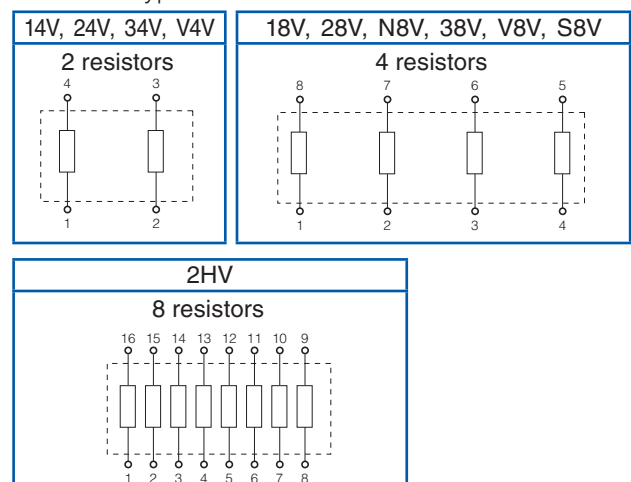

## Ratings

Item		Specifications
Resistance Range		10 Ω to 1 MΩ : E24 series
Resistance Tolerance		J : ±5 %
Number of Terminals	14V,24V,V4V,34V	4 terminal
	18V,28V,N8V,38V,V8V,S8V	8 terminal
	2HV	16 terminal
Number of Resistors	14V,24V,V4V,34V	2 element
	18V,28V,N8V,38V,V8V,S8V	4 element
	2HV	8 element
Power Rating at 70 °C	14V,N8V	0.031 W/element
	18V	0.031 W/element (0.1 W/package)
	24V,28V,V4V,34V,V8V,38V	0.063 W/element
	S8V	0.1 W/element
	2HV	0.063 W/element (0.25 W/package)

Item		Specifications	
Limiting Element Voltage <sup>(1)</sup>	14V,18V	12.5 V	
	2HV	25 V	
	24V,28V,N8V,38V,34V,V4V,V8V	50 V	
	S8V	100 V	
Maximum Overload Voltage <sup>(2)</sup>	14V,18V	25 V	
	2HV	50 V	
	24V,28V,N8V,38V,34V,V4V,V8V	100 V	
	S8V	200 V	
T.C.R.		±200×10 <sup>-6</sup> /°C	
Category Temperature Range		-55 °C to 125 °C	
Jumper Array	Rated Current	14V,18V	0.5 A
		2HV,24V,28V,N8V,38V,34V,V4V,V8V	1 A
		S8V	2 A
	Maximum Overload Current	14V,18V	1 A
		2HV,24V,28V,N8V,38V,34V,V4V,V8V	2 A
		S8V	4 A

(1) Rated Continuous Working Voltage (RCWV) shall be determined from  $RCWV = \sqrt{\text{Power Rating} \times \text{Resistance Value}}$ , or Limiting Element Voltage listed above, whichever less.

(2) Overload (Short-time Overload) Test Voltage (SOTV) shall be determined from  $SOTV = 2.5 \times RCWV$  or max. Overload Voltage listed above whichever less.

### Power Derating Curve

For resistors operated in ambient temperatures above 70 °C, power rating shall be derated in accordance with the figure on the right.

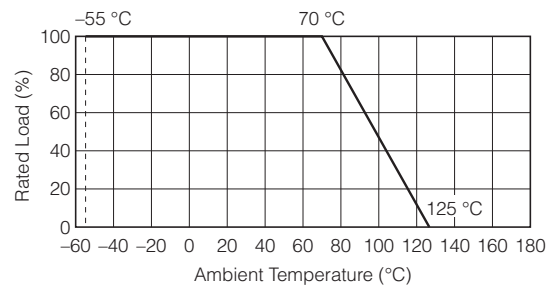

## Dimensions in mm (not to scale)

### (1) Convex Terminal type

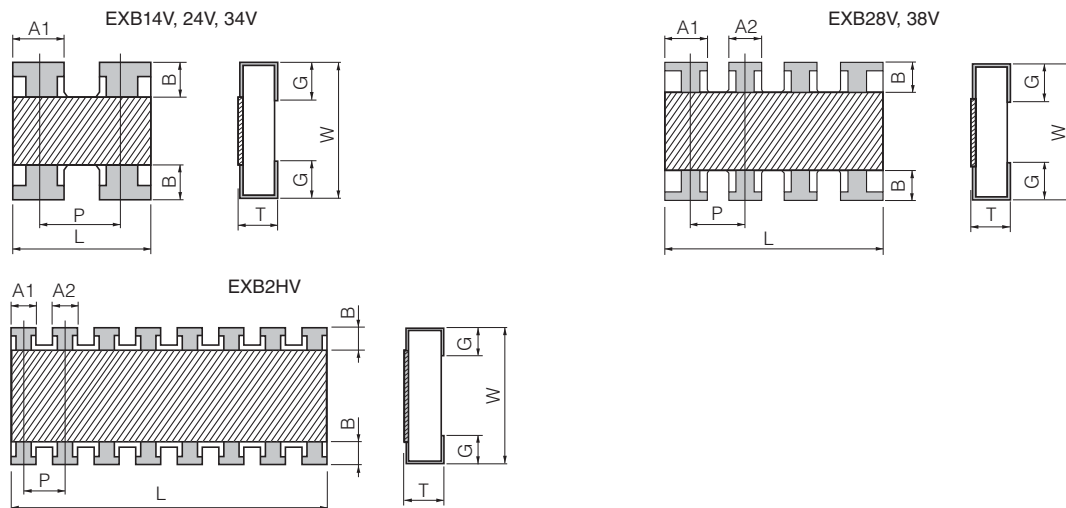

Part No. (inch size)	Dimensions (mm)								Mass (Weight) [g/1000 pcs.]
	L	W	T	A1	A2	B	P	G	
EXB14V (0201×2)	0.80 <sup>±0.10</sup>	0.60 <sup>±0.10</sup>	0.35 <sup>±0.10</sup>	0.35 <sup>±0.10</sup>	—	0.15 <sup>±0.10</sup>	(0.50)	0.15 <sup>±0.10</sup>	0.5
EXB24V (0402×2)	1.00 <sup>±0.10</sup>	1.00 <sup>±0.10</sup>	0.35 <sup>±0.10</sup>	0.40 <sup>±0.10</sup>	—	0.18 <sup>±0.10</sup>	(0.65)	0.25 <sup>±0.10</sup>	1.2
EXB28V (0402×4)	2.00 <sup>±0.10</sup>	1.00 <sup>±0.10</sup>	0.35 <sup>±0.10</sup>	0.45 <sup>±0.10</sup>	0.35 <sup>±0.10</sup>	0.20 <sup>±0.10</sup>	(0.50)	0.25 <sup>±0.10</sup>	2.0
EXB2HV (0402×8)	3.80 <sup>±0.10</sup>	1.60 <sup>±0.10</sup>	0.45 <sup>±0.10</sup>	0.35 <sup>±0.10</sup>	0.35 <sup>±0.10</sup>	0.30 <sup>±0.10</sup>	(0.50)	0.30 <sup>±0.10</sup>	9.0
EXB34V (0603×2)	1.60 <sup>±0.20</sup>	1.60 <sup>±0.15</sup>	0.50 <sup>±0.10</sup>	0.65 <sup>±0.15</sup>	—	0.30 <sup>±0.20</sup>	(0.80)	0.30 <sup>±0.20</sup>	3.5
EXB38V (0603×4)	3.20 <sup>±0.20</sup>	1.60 <sup>±0.15</sup>	0.50 <sup>±0.10</sup>	0.65 <sup>±0.15</sup>	0.45 <sup>±0.15</sup>	0.30 <sup>±0.20</sup>	(0.80)	0.35 <sup>±0.20</sup>	7.0

( ) Reference

### (2) Concave Terminal type

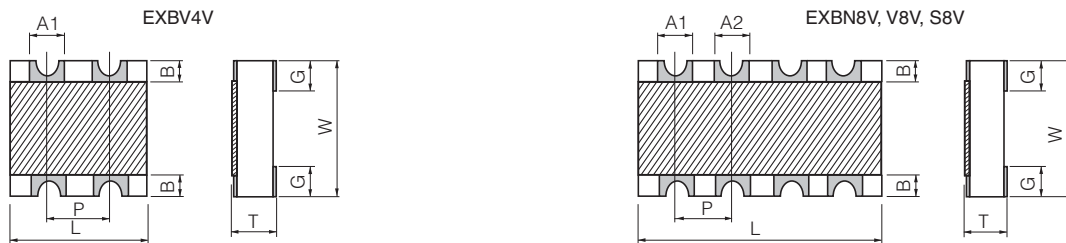

Part No. (inch size)	Dimensions (mm)								Mass (Weight) [g/1000 pcs.]
	L	W	T	A1	A2	B	P	G	
EXBN8V (0402×4)	2.00 <sup>±0.10</sup>	1.00 <sup>±0.10</sup>	0.45 <sup>±0.10</sup>	0.30 <sup>±0.10</sup>	0.30 <sup>±0.10</sup>	0.20 <sup>±0.15</sup>	(0.50)	0.30 <sup>±0.15</sup>	3.0
EXBV4V (0603×2)	1.60 <sup>+0.20/-0.10</sup>	1.60 <sup>+0.20/-0.10</sup>	0.60 <sup>±0.10</sup>	0.60 <sup>±0.10</sup>	—	0.30 <sup>±0.15</sup>	(0.80)	0.45 <sup>±0.15</sup>	5.0
EXBV8V (0603×4)	3.20 <sup>+0.20/-0.10</sup>	1.60 <sup>+0.20/-0.10</sup>	0.60 <sup>±0.10</sup>	0.60 <sup>±0.10</sup>	0.60 <sup>±0.10</sup>	0.30 <sup>±0.15</sup>	(0.80)	0.45 <sup>±0.15</sup>	10
EXBS8V (0805×4)	5.08 <sup>+0.20/-0.10</sup>	2.20 <sup>+0.20/-0.10</sup>	0.70 <sup>±0.20</sup>	0.80 <sup>±0.15</sup>	0.80 <sup>±0.15</sup>	0.50 <sup>±0.15</sup>	(1.27)	0.55 <sup>±0.15</sup>	30

( ) Reference

### (3) Flat Terminal type

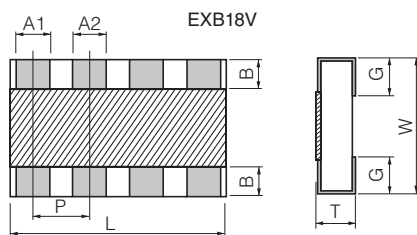

Part No. (inch size)	Dimensions (mm)								Mass (Weight) [g/1000 pcs.]
	L	W	T	A1	A2	B	P	G	
EXB18V (0201×4)	1.40±0.10	0.60±0.10	0.35±0.10	0.20±0.10	0.20±0.10	0.10±0.10	(0.40)	0.20±0.10	1.0

( ) Reference